

CATÁLOGO CATALOGUE



CATÁLOGO

CATALOGUE

Introducción	4
1.1 Válvulas y filtros de latón	11
Válvulas esfera de roscar	12
Válvulas esfera de soldar	18
Válvulas esfera de empotrar	19
Válvulas esfera multicapa	21
Válvulas esfera mini	22
Válvulas de retención	23
Válvulas de escuadra	25
Válvulas de compuerta	27
Válvulas de seguridad y antigolpe de ariete	28
Grifos de jardín	29
Grifos lavadora y barril	31
Reductor de presión	33
Desfangador y filtro magnético	34
Filtros	35
1.2 Válvulas y filtros de acero inoxidable	37
Válvulas esfera	38
Grifos	44
Válvulas de retención	45
Válvulas de compuerta	46
Filtros	47
1.3 Válvulas y filtros de fundición	49
Válvulas de mariposa	50
Válvulas de retención	57
Válvulas de compuerta	58
Válvulas esfera	59
Válvulas de globo	60
Filtros	61
Manguitos elásticos	62
1.4 Válvulas y filtros de plástico	65
Válvulas esfera	66
2.1 Accesorios y bridas de latón	69
Multicapa compresión	70
Multicapa prensar universal	73
Multicapa prensar tipo U	76
Sistema PEX	84
Roscados	85
Roscados cromados	95
Tubería Cu	98
PE - Tuerca hembra	101
PE - Tuerca macho	103
PE - Brida	106
PE - A presión	108
PE-Fe - Para tubo de hierro	110
Bicono a compresión niquelado	111
Bicono a compresión	114
MT Garden	118
2.2 Accesorios y bridas de acero inoxidable	121
Sistema MT Press	122
Abarcones	131
Roscados	133
Soldados	140
Bridas	146

2.3 Accesorios y bridas de hierro maleable galvanizado	161
Roscados	162
3 Automatización de válvulas	171
4 Conexiones flexibles	193
5 Instrumentos de medición	197
6 MAC3	201
7 Accesorio sanitarios	209
Válvulas de descarga y llenado	210
Flexos de ducha	212
Válvulas de flotador y boyas	213
Válvulas click clack	214
8 Adhesivos y sellantes PTFE	215
9 Recambios	219
Condiciones de venta	226
Índice de referencias	227
Anexo	231

Introduction	4
1.1 Brass valves and filters	11
Threaded ball valves	12
Solder ball valves	18
Long neck ball valves	19
Multilayer ball valves	21
Mini ball valves	22
Non return valves	23
Angle valves	25
Gate valves	27
Safety and water hammer damper valves	28
Bibcock	29
Barrel and washing machine valves	31
Pressure reducing valves	33
Magnetic dirt separator strainer	34
Filters	35
1.2 Stainless steel valves and filters	37
Ball valves	38
Bibcock	44
Non return valves	45
Gate valves	46
Filters	47
1.3 Casting valves and filters	49
Butterfly valves	50
Non return valves	57
Gate valves	58
Ball valves	59
Globe valves	60
Filters	61
Expansion joints	62
1.4 Plastic valves and filters	65
Ball valves	66
2.1 Brass fittings and flanges	69
Compression multilayer	70
Press multilayer universal	73
Press multilayer type U	76
PEX system	84
Threaded	85
Chromed plated threaded	95
Cu pipe	98
PE - Female nut	101
PE - Male nut	103
PE - Flange	106
PE - To pressure	108
PE-Fe - For iron pipe	110
Nickel plated compression bicone	111
Compression bicone	114
MT Garden	118
2.2 Stainless steel fittings and flanges	121
MT Press System	122
U-bolts	131
Threaded	133
Soldered	140
Flanges	146

2.3 Malleable galvanized iron fittings and flanges	161
Threaded	162
3 Valves automation	171
4 Flexible connections	193
5 Measurement tools	197
6 MAC3	201
7 Sanitary fittings	209
Flush and fill valves	210
Shower hose	212
Float valves and buoys	213
Click clack valves	214
8 PTFE adhesives and sealants	215
9 Spare Parts	219
Sales conditions	226
References index	227
Annex	231



MT es una multinacional española que fabrica y comercializa productos y accesorios para la canalización y conducción de fluidos en más de 40 países.

Desde 1994 MT diseña, produce y comercializa una amplia gama de productos para el segmento hidrosanitario e industrial entre los que destacan los accesorios y las válvulas de latón, accesorios de acero inoxidable, bridas y válvulas industriales, entre otros.

Con una alta cuota de mercado, MT se posiciona como una de las empresas más completas en soluciones integrales para la conducción de fluidos, segmento clave para el sector industrial, tratamientos de agua y riego, usos hidrosanitarios, automatización, instrumentación, etc.

La compañía basa su estrategia en la satisfacción del cliente con una excelente relación calidad precio en más de 4.000 referencias especialmente producidas para el profesional distribuidor.

Actualmente, MT cuenta con una red de distribuidores propios en más de 12 países, una filial en México (MT América) y clientes en más de 40 países.

MT is a spanish multinational company that manufactures and distributes products and accessories for the canalization and conduction of fluids in more than 40 countries.

Since 1994 MT has been designing, producing and marketing a wide range of products for the hydrosanitary and industrial segment, including brass valves and fittings, stainless steel fittings, flanges and industrial valves, among others.

With a nice market presence, MT is positioned as one of the most complete companies in integral solutions for the conduction of fluids, key segment for the industrial sector, water and irrigation treatments, hydrosanitary uses, automation, instrumentation, etc.

The aim of the company is the customer satisfaction, trying to give the best quality – price combination in more than 4,000 references, specially made for the professional distributor.

Nowadays, MT has a network of its own distributors in more than 12 countries, a subsidiary in Mexico (MT America) and clients in more than 40 countries.



PACK DIGITAL DE DATOS

DIGITAL DATA PACK

Pack digital de datos para distribuidores, industriales y plataformas de venta online.

En pleno proceso de digitalización, MT ha centralizado toda la información técnica y comercial de su catálogo de productos en una única y permanentemente actualizada base de datos. Se trata de la tecnología PIM (Product Information Manager).

Nuestro PIM ofrece la posibilidad de tener acceso a toda la gama de productos MT clasificada y ordenada, proporcionando esta información en los principales formatos digitales:

Digital data pack for distributors, industry and online sales platforms.

In the digitalization process, MT has centralized all the commercial and technical information of its product catalog in a unique and permanently updated database. This is known as PIM (Product Information Manager) technology.

Our PIM offers the possibility of having access to all the range of MT products classified and ordered, providing this information in the main digital formats:



BMEcat

Para canales de distribución profesionales
For channels of distribution professionals



BC3

Para prescriptores: Presto, Cype, etc.
For prescribers: Presto, Cype, etc.



Daterium

Suministro industrial, ferretería y materiales de construcción
Industrial Supply, Hardware and building materials stores



Go! Catalog

Plataforma del sector hidrosanitario e industrial
Digital catalog for Hidrosanitary and Industrial platforms

ACCEDE A NUESTROS CONECTORES

ACCESS TO OUR CONNECTORS

Estos formatos permiten tener un acceso rápido y fiable a una información de calidad útil para:

- Catálogos
- Puntos de venta
- Tiendas online
- Sistemas de información para ingenierías e instaladores

These formats allow fast and reliable access to quality information useful for:

- Catalogues
- Points of sale
- Online stores
- Information systems for engineering and installers

DESCARGA AQUÍ
DOWNLOAD HERE



EMPRESA

COMPANY

TRAYECTORIA

TIMELINE

MT Valves and Fittings cuenta con casi tres décadas de experiencia en el sector. Más de 28 años de trayectoria siendo una referencia en un mercado que conoce y con el que evoluciona año tras año para adaptarse a las exigencias y necesidades de sus clientes.

MT Valves and Fittings has close to three decades of expertise. More than 28 years of experience being a reference in a Global market adapting ourselves to customers needs.



INTERNACIONAL

INTERNATIONAL

MT ha consolidado una red de distribución internacional, entendiendo las especificidades que marca cada mercado y adaptando certificaciones y requerimientos de cada país. Presentes en más de 45 países, con representaciones en MT México, MT Rusia y MT Índico, poniendo en relieve la vocación internacional de la compañía.

MT has consolidated an international distribution network, understanding the specificities that mark each market and adapting the certifications and requirements of each country. MT is present in more than 45 countries with branches in MT Mexico, MT Russia and MT Indic.



ESTRUCTURA INTERNA

INTERNAL STRUCTURE

Comercial, diseño e I+D, administración, compras, marketing y taller. Gracias a una estructura interna 360, nuestro modelo logístico se diferencia por proporcionar una estrategia comercial integral y ágil que nos permite ajustar la producción a las necesidades reales del mercado para ofrecer unos precios altamente competitivos.

Our 360° internal structure allows us to adjust production to the real needs of each market, offering professionals highly competitive prices.

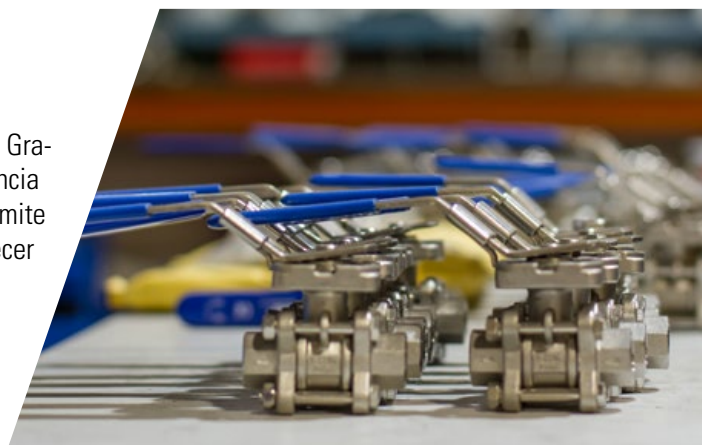

Servicio urgente 24/48h
Urgent service 24/48h

OFICINAS

OFFICES

Disponemos de sede comercial, técnica y logística ubicada en la zona estratégica del área metropolitana de Barcelona (Pallejà). Unas instalaciones modernas y adaptadas para la gestión logística y la correcta distribución de nuestros productos, así como la atención al cliente y la permanente comunicación con el taller y el almacén.

We have our logistic and technical headquarters located in the area of Barcelona (Spain). Modern and automatized facilities, adapted for administrative management and efficient customer service.



ALMACÉN

WAREHOUSE

Más de 10.000 metros cuadrados preparados para almacenar y suministrar de forma ágil y eficiente más de 6.000 referencias. Nuestra máxima preocupación: no sobre-estocar al cliente, por eso contamos con un amplio stock con el que aseguramos la mayor flexibilidad logística.

More than 10.000 square meters prepared to store and supply over 6.000 MT references. Our maximum concern: not over-store the customer.



PRODUCCIÓN

PRODUCT DEVELOPMENT

En MT Valves & Fittings contamos con un Departamento de Ingeniería e I + D propio. Un equipo enfocado 100% en el desarrollo de mejores accesorios y piezas y el seguimiento y control de todos los procesos para conseguir un producto competitivo de alta calidad.

At MT Valves & Fittings we have our Engineering and R&D Department. A team focused 100% on the innovation and development of valves and fittings.



PRODUCTOS

PRODUCTS



HIDROSANITARIO

HYDROSANITARY

La división hidrosanitaria agrupa todos los productos específicamente diseñados para la canalización y conducción de fluidos para los sectores de construcción, fontanería, riego y jardín. Se trata de una amplia gama de productos en la que encontraremos accesorios de hierro maleable galvanizado, válvulas de latón y accesorios de latón, reductoras de presión, válvulas de PVC, válvulas y descargas para WC, manómetros, y una selección de los productos más importantes de MAC3, fabricante mundial de productos electrónicos para sistemas hidráulicos.

The hydrosanitary division contains all the products, specifically designed for the canalization and conduction of fluids for the construction, plumbing, irrigation and gardening sectors. A wide range of products in which we find malleable galvanized iron fittings, brass valves and brass fittings, pressure reducers, PVC valves, WC valves and discharges, manometers and a selection of the most important products of MAC3, an Italian manufacturer of electronic products for hydraulic systems.

INDUSTRIAL

INDUSTRIAL

La división industrial ofrece piezas de gran calidad de acero inoxidable específicamente pensados para el ámbito industrial. Toda la gama está fabricada bajo estrictos parámetros de calidad cumpliendo con las más altas certificaciones en conducción de fluidos. Se trata de una amplia gama de productos inox con referencias de bridas y valonas de acero inoxidable, accesorio roscado de acero inoxidable, accesorios para la soldadura de tubo inoxidable, MT Press para prensar, válvulas inoxidables, válvulas de fundición y automatismos.

The industrial division offers high quality stainless steel parts specifically designed for the industrial sector. The entire range is manufactured under strict quality parameters that comply with the highest certifications in conducting fluids. A wide range of stainless steel products including stainless steel flanges, threaded fittings, welding accessories, MT Press fitting, casting valves, ductile valves and automatismos.



CERTIFICACIONES

CERTIFICATIONS

Desde su creación, MT ha apostado por fijar objetivos de calidad e innovación sobre los que construir productos eficientes, seguros, duraderos y altamente rentables. La compañía permanece totalmente alineada con la legislación Europea, cada vez más estricta en sus políticas medioambientales, seguridad e higiene, y apuesta por el desarrollo continuo de nuevas líneas de producción. MT es hoy referente en calidad y homologaciones.

Since its inception, MT has focused its efforts on establishing quality and innovation objectives to build efficient, safe, durable and highly profitable products. The company remains fully aligned with European legislation, keeping ourselves strict in its policies on environment, safety and hygiene, and is committed to the continuous development of new production lines. MT is now a benchmark in quality and approvals.



Certificado TÜV para la Gestión de la Calidad

La organización demuestra su capacidad para diseñar, producir y comercializar productos o servicios que satisfacen los requisitos del cliente y los reglamentos aplicables según la norma UNE-EN ISO 9001.

TÜV Quality Management Certificate

The organization demonstrates its ability to design, produce and deliver products or services that meet customer and regulatory requirements applicable to UNE-EN ISO 9001.



Repto es el sistema de precalificación del sector energético utilizado en Sudamérica y el Sur de Europa. Fundada en España por empresas del sector energético que desean expandirse en el extranjero, la comunidad continúa respaldando a empresas multinacionales en la captación y gestión de proveedores de alto rendimiento.

Repto is the energy sector prequalification system used in South America and Southern Europe. Founded in Spain by companies in the energy sector looking to expand abroad, the community continues to support multinational companies in recruiting and managing high-performance suppliers.



La Asociación alemana del sector de gas y agua (DVGW) certifica, entre otros, materiales de sellado para el abastecimiento de gas en Alemania.

The German Association of the Gas and Water Industry (DVGW) certifies, among other things, sealing materials for gas supply in Germany.

DVGW



Certificación para el empleo de materiales de juntas de sellado con agua potable de acuerdo con la norma británica BS 6920.

Certification for the use of sealing gasket materials with drinking water in accordance with British Standard BS 6920.

WRAS



Autorización oficial expedida por la Dirección General Sanitaria francesa desde 1998. Se aplica a los materiales constitutivos de los equipos que están en contacto con el agua destinada al consumo humano así como a los equipos en sí.

Official authorization issued by the General Directorate of Health since 1998 (ACS certification). It is applied to equipment constituting materials that are in contact with water intended for human consumption, as well as to the equipment itself.

ACS



Autorización oficial expedida por Le Centre Scientifique et Technique du Bâtiment (CSTB).

Official authorization issued by the Center Scientifique et Technique du Bâtiment (CSTB).

CSTB



Certificación de sistemas de tubería multicapa para instalaciones de agua potable (caliente y fría) en edificación de acuerdo con la normativa EN ISO 21003.

Certification of multilayer piping systems for hot and cold drinking water inside buildings in accordance with EN ISO 21003.

KIWA



Certificado de sistema tubería PE-X para instalaciones de agua caliente y fría en instalaciones de agua sanitaria y calefacción de acuerdo a normativa UNE-EN ISO 15875 y BRL 5606.

Certification of PE-X piping systems for hot and cold drinking water and heating installations in accordance with UNE-EN ISO 15875 and BRL 5606.

KOMO



Certificación conforme el producto cumple con la normativa UNE-EN 13828 (diseño) y la NKB-13 (migración metales pesados).

Certification according the product complies with UNE-EN 13828 (design) and NKB-13 (heavy metal migration).

SINTEF



Certificación oficial expedida por el Instituto Nacional de Sanidad Pública de Polonia. Se aplica a los materiales constitutivos de los equipos que están en contacto con el agua destinada al consumo humano.

Official certificate issued by the National Institute of Public Hygiene of Poland. It is applied to equipment constituting materials that are in contact with water intended for human consumption.

PZH



Certificación de conformidad para los productos que cumplen con todos los reglamentos técnicos de la Unión Aduanera Euroasiática.

Product compliance Certificate according to the technical regulations of the Eurasian Custom Union.

EAC



AENOR N es símbolo de la calidad y seguridad de producto, evidencia el cumplimiento de los requisitos definidos en normas o especificaciones técnicas.

AENOR N is a symbol of product quality and safety, evidence of compliance with the requirements defined in standards or technical specifications.

AENOR

1

VÁLVULAS Y FILTROS

VALVES AND FILTERS

1.1 LATÓN 11
1.1 BRASS

1.2 ACERO INOXIDABLE 37
1.2 STAINLESS STEEL

1.3 FUNDICIÓN 49
1.3 CASTING

1.4 PLÁSTICO 65
1.4 PLASTIC

La amplia gama de válvulas MT pretende cubrir todas las necesidades del mercado intentando satisfacer las diferentes particularidades en todas las zonas del territorio internacional y las distintas aplicaciones en sectores como la industria, fontanería, calefacción, riego, etc...

Para ello, disponemos de válvulas PN-10, PN-16, PN-25, PN-30 y PN-40, con cierre metálico y cierre elástico, distinto rango de temperaturas máximas, fluidos, lubricantes, hidrocarburos, alivio de presión y sistema antihielo, así como la disposición de accionamiento mediante palanca, palomilla, volante o cuadradillo y la posibilidad de conectar algunos modelos a tuberías de cobre, PEX, multicapas, por compresión en tuberías rígidas, polietileno o a través de rosca gas, H-H, M-H y M-M.

También tenemos a su disposición recambios para alargaderas, racores para la adaptación de mangueras, tamices para los filtros "Y" así como mandos con sus correspondientes florones para las válvulas de empotrar.

The wide range of MT valves tries to cover every needs of the market trying to satisfy all particularities in every zone of the international territory and the different applications in sectors such as Industry, Plumbing, Heating, Irrigation, etc.

That's why we have valves from PN-10, PN-16, PN-25, PN-30 y PN-40, with metallic closing and resilient wedge, different range of temperatures, fluids, lubricants, hydrocarbons, pressure relief and nofrost system, as well as the disposition of operation by plane handle, butterfly handle, hand wheel or square handle for connecting some models to copper pipelines, PEX, Multilayer, for compression rigid pipelines, polyethylene or throw gas thread, F-F, M-F and M-M.

In addition, we can offer spare parts for elongations, fittings for hose connections, filters for the strainer filter "Y" and handles with their rossetes for solder ball valve.



1

VÁLVULAS Y FILTROS

VALVES AND FILTERS

1.1

LATÓN

BRASS

Rango de temperatura °C
Temperature range °C

 -20°
180°

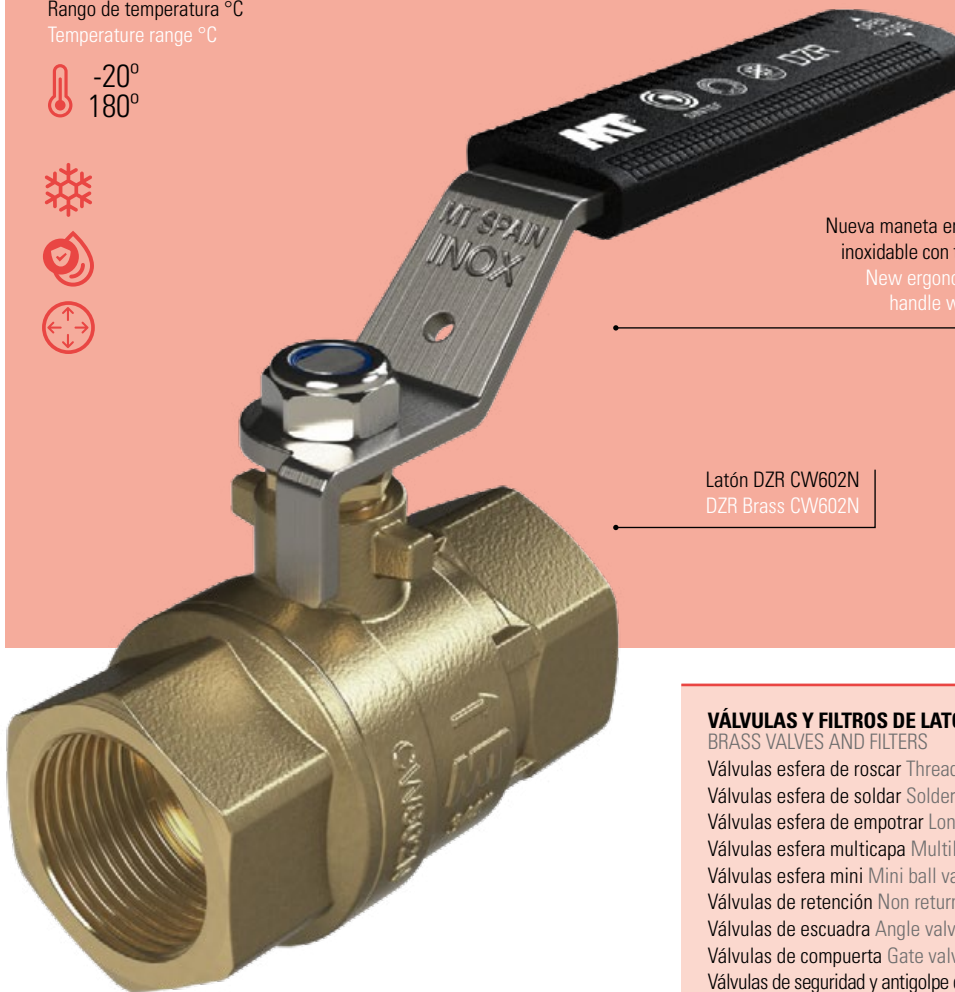

Nueva maneta ergonómica en acero inoxidable con tuerca autoblocante
New ergonomic stainless steel handle with self-locking nut

Latón DZR CW602N
DZR Brass CW602N

Producto 4104

Válvula esfera PN-40 H-H paso total en latón DZR palanca ergonómica color negro acero inoxidable (p.12)

Product 4104

F-F DZR brass ball valve PN-40 full bore with black ergonomic stainless steel handle (p.12)

VÁLVULAS Y FILTROS DE LATÓN

BRASS VALVES AND FILTERS

Válvulas esfera de roscar Threaded ball valves	12
Válvulas esfera de soldar Solder ball vales	18
Válvulas esfera de empotrar Long neck ball valves	19
Válvulas esfera multicapa Multilayer ball valves	21
Válvulas esfera mini Mini ball valves	22
Válvulas de retención Non return valves	23
Válvulas de escuadra Angle valves	25
Válvulas de compuerta Gate valves	27
Válvulas de seguridad y antigolpe de ariete Safety and water hammer damper valves	28
Grifos de jardín Bibcock	29
Grifos lavadora y barril Barrel and washing machine valves	31
Reductoras de presión Pressure reducing valves	33
Desfangador y filtro magnético Magnetic dirt separator strainer	34
Filtros Filters	35



Management System
ISO 9001:2015



www.tuv.com
ID 9108643013



VÁLVULAS ESFERA DE ROSCAR THREADED BALL VALVES



PLATINUM SERIES

- Paso total
- Sistema Antihielo
- Cuerpo reforzado
- Latón DZR CW602N
- Eje en acero inoxidable
- Nueva maneta ergonómica en acero inoxidable con tuerca autoblocante. Alta resistencia frente a la corrosión
- Juntas en FKM
- -20°C / 180°C
- Full bore
- Nofrost System
- Reinforced body
- DZR Brass CW602N
- Stainless steel stem
- New ergonomic stainless steel handle with self-locking nut. High protection from corrosion
- FKM o-rings
- -20°C / 180°C

PN
40

· **Recambios** disponibles en página 220
Spare parts available page 220



CÓDIGO CODE _____
MEDIDA SIZE _____
ENCAJADO GRANDE MASTER CARTON _____
ENCAJADO INTERMEDIO INNER CARTON _____

4104



Válvula esfera PN-40 H-H
paso total en latón DZR
palanca ergonómica color
negro acero inoxidable

F-F DZR brass ball valve
PN-40 full bore with black
ergonomic stainless steel
handle

PLATINUM

DZR SINTEF ACS

ANTIHIELO / NOFROST EAN CODE

4104-015	1/2"	48	12
4104-020	3/4"	32	8
4104-025	1"	20	5
4104-032	1 1/4"	12	3
4104-040	1 1/2"	12	2
4104-050	2"	12	2



FICHA TÉCNICA
TECHNICAL SHEET

4504



Válvula esfera PN-40 M-H
paso total en latón DZR
palanca ergonómica color
negro acero inoxidable

M-F DZR brass ball valve
PN-40 full bore with black
ergonomic stainless steel
handle

PLATINUM

DZR SINTEF ACS

ANTIHIELO / NOFROST EAN CODE

4504-015	1/2"	40	10
4504-020	3/4"	24	6
4504-025	1"	16	4
4504-032	1 1/4"	12	3
4504-040	1 1/2"	12	2
4504-050	2"	12	1



FICHA TÉCNICA
TECHNICAL SHEET

4204



Válvula esfera PN-40 H-H
paso total en latón DZR
mando palomilla color
negro

F-F DZR brass ball valve
PN-40 full bore with black
butterfly handle

PLATINUM

DZR SINTEF ACS

ANTIHIELO / NOFROST EAN CODE

4204-015	1/2"	60	15
4204-020	3/4"	44	11
4204-025	1"	28	7



FICHA TÉCNICA
TECHNICAL SHEET

4604



Válvula esfera PN-40 M-H
paso total en latón DZR
mando palomilla color
negro

M-F DZR brass ball valve
PN-40 full bore with black
butterfly handle

PLATINUM

DZR SINTEF ACS

ANTIHIELO / NOFROST EAN CODE

4604-015	1/2"	60	15
4604-020	3/4"	44	11
4604-025	1"	28	7



FICHA TÉCNICA
TECHNICAL SHEET



**GOLD
SERIES**

- Paso total
- Sistema Antihielo
- Certificado ACS
- Cuerpo reforzado
- Latón CW617N
- Nueva maneta ergonómica en acero inoxidable con tuerca autoblocante.
- -20°C / 120°C
- Full bore
- Nofrost System
- ACS certified
- Reinforced body
- Brass CW617N
- New ergonomic stainless steel handle with self-locking nut.
- -20°C / 120°C

**PN
30**

• **Recambios** disponibles en página 220
Spare parts available page 220



CÓDIGO CODE _____
MEDIDA SIZE _____
ENCAJADO GRANDE MASTER CARTON _____
ENCAJADO INTERMEDIO INNER CARTON _____

4295 ■



42952 ■



Válvula esfera PN-30 H-H paso total palanca ergonómica acero inoxidable en color rojo y azul

F-F brass ball valve PN-30 full bore ergonomic stainless steel handle red and blue color

GOLD
PZH WRAS ACS
ANTIHIELO / NOFROST EAN CODE

4295-008	42952-008	1/4"	72	12
4295-010	42952-010	3/8"	72	12
4295-015	42952-015	1/2"	54	9
4295-020	42952-020	3/4"	36	9
4295-025	42952-025	1"	24	6
4295-032	42952-032	1 1/4"	16	4
4295-040	42952-040	1 1/2"	8	2
4295-050	42952-050	2"	12	2
4295-065*	42952-065*	2 1/2"	6	1
4295-080*	42952-080*	3"	4	1
4295-100*	42952-100*	4"	2	1

• * No incorpora sistema antihielo.
* Without nofrost system.



**FICHA TÉCNICA
TECHNICAL SHEET**

4097 ■



40972 ■



Válvula esfera PN-30 M-H paso total palanca ergonómica acero inoxidable en color rojo y azul

M-F brass ball valve PN-30 full bore ergonomic stainless steel handle red and blue color

GOLD
PZH WRAS ACS
ANTIHIELO / NOFROST EAN CODE

4097-010	40972-010	3/8"	72	12
4097-015	40972-015	1/2"	54	9
4097-020	40972-020	3/4"	36	9
4097-025	40972-025	1"	24	6
4097-032	40972-032	1 1/4"	16	4
4097-040	40972-040	1 1/2"	8	2
4097-050	40972-050	2"	12	2



**FICHA TÉCNICA
TECHNICAL SHEET**

4098 ■



40982 ■



Válvula esfera PN-30 M-M paso total palanca ergonómica acero inoxidable en color rojo y azul

M-M brass ball valve PN-30 full bore ergonomic stainless steel handle red and blue color

GOLD
PZH WRAS ACS
ANTIHIELO / NOFROST EAN CODE

4098-015	40982-015	1/2"	48	12
4098-020	40982-020	3/4"	36	9
4098-025	40982-025	1"	24	6
4098-032	40982-032	1 1/4"	12	3
4098-040	40982-040	1 1/2"	12	2
4098-050	40982-050	2"	12	2



**FICHA TÉCNICA
TECHNICAL SHEET**

CÓDIGO CODE _____
MEDIDA SIZE _____
ENCAJADO GRANDE MASTER CARTON _____
ENCAJADO INTERMEDIO INNER CARTON _____

41062 ■



4106 ■



Válvula esfera dos piezas
PN-30 M-H mando palomilla
en color rojo y azul

M-F ball valve PN-30 with
two pieces connector and
butterfly handle red and
blue color

GOLD
PZH WRAS ACS
ANTIHIELO / NOFROST EAN CODE

41062-015	4106-015	1/2"	54	9
41062-020	4106-020	3/4"	36	9
41062-025	4106-025	1"	24	6
	4106-032*	1 1/4"	8	2
	4106-040*	1 1/2"	12	2
	4106-050*	2"	6	1

* Solo disponible en palanca en acero inoxidable
* Only available stainless steel handle



FICHA TÉCNICA
TECHNICAL SHEET

4102 ■



41022 ■



Válvula esfera PN-30 H-H
paso total mando palomilla
en color rojo y azul

F-F brass ball valve PN-30
full bore with butterfly
handle red and blue color

GOLD
PZH WRAS ACS
ANTIHIELO / NOFROST EAN CODE

4102-010	41022-010	3/8"	72	12
4102-015	41022-015	1/2"	60	10
4102-020	41022-020	3/4"	36	9
4102-025	41022-025	1"	24	6



FICHA TÉCNICA
TECHNICAL SHEET

4103 ■



41032 ■



Válvula esfera PN-30 M-H
paso total mando palomilla
en color rojo y azul

M-F brass ball valve PN-30
full bore with butterfly
handle red and blue color

GOLD
PZH WRAS ACS
ANTIHIELO / NOFROST EAN CODE

4103-008	41032-008	1/4"	72	12
4103-010	41032-010	3/8"	72	12
4103-015	41032-015	1/2"	60	10
4103-020	41032-020	3/4"	36	9
4103-025	41032-025	1"	24	6



FICHA TÉCNICA
TECHNICAL SHEET

4100



Válvula esfera PN-30
palanca acero inoxidable
color rojo con conexión PE

F-F ball valve PN-30 full
bore ergonomic stainless
steel handle with PE
connections

GOLD
EAN CODE

4100-020		20	24	6
4100-025		25	16	4
4100-032		32	12	3

• Compatible con accesorios Serie 88 y Serie 99
Compatible with Series 88 and Series 99 fittings



FICHA TÉCNICA
TECHNICAL SHEET

4101



Válvula esfera PN-30 palanca
acero inoxidable color
rojo con conexión PE-H

F-F ball valve PN-30 full
bore ergonomic stainless
steel handle with PE-H

GOLD
EAN CODE

4101-01520		1/2" x 20	32	8
4101-02025		3/4" x 25	24	6
4101-02532		1" x 32	16	4

• Compatible con accesorios Serie 88 y Serie 99
Compatible with Series 88 and Series 99 fittings



FICHA TÉCNICA
TECHNICAL SHEET

CÓDIGO CODE _____
MEDIDA SIZE _____
ENCAJADO GRANDE MASTER CARTON _____
ENCAJADO INTERMEDIO INNER CARTON _____

4099



Válvula esfera PN-30 H-H
doble toma con purga pa-
lanca de acero inoxidable

F-F ball valve PN-30 with
double outlet stainless
steel handle

EAN CODE

4099-015	1/2"	20	5
4099-020	3/4"	16	4
4099-025	1"	12	3
4099-032	1 1/4"	12	2
4099-040	1 1/2"	12	2



FICHA TÉCNICA
TECHNICAL SHEET

4105



Válvula esfera PN-30
cuadradillo H-H

F-F ball valve PN-30 square
handle

ACS

EAN CODE

4105-015*	1/2"	60	10
4105-020*	3/4"	36	9
4105-025*	1"	24	6
4105-032*	1 1/4"	16	4
4105-040**	1 1/2"	8	2
4105-050**	2"	8	1

*Cuadradillo 20mm. / **Cuadradillo 24,5mm.
*Square handle 20mm. / **Square handle 24,5mm.



FICHA TÉCNICA
TECHNICAL SHEET

4124



Válvula esfera PN-30
cuadradillo H-H (27mm)

F-F ball valve PN-30 square
handle (27mm)

ACS

EAN CODE

4124-015	1/2"	48	12
4124-020	3/4"	36	9
4124-025	1"	24	6
4124-032	1 1/4"	16	4
4124-040	1 1/2"	8	2
4124-050	2"	8	1



FICHA TÉCNICA
TECHNICAL SHEET

6651 ■

66512 ■

NEW



Válvula esfera PN-30
palanca inoxidable enlace
compresión latón color rojo
y azul

Ball valve PN-30 stainless
handle brass compression
connection red and blue
color

GOLD

EAN CODE

6651-015	66512-015	15	40	10
6651-018	66512-018	18	40	10
6651-022	66512-022	22	28	7

• Compatible con tubo de cobre y acero inoxidable
Serie 66 y 67
Compatible with 66 and 67 Series copper and
stainless steel pipe



FICHA TÉCNICA
TECHNICAL SHEET

6650 ■

66502 ■

NEW



Válvula esfera PN-30
mando palomilla enlace
compresión latón color rojo
y azul

Ball valve PN-30 butterfly
handle brass compression
connection red and blue
color

GOLD

EAN CODE

6650-015	66502-015	15	40	10
6650-018	66502-018	18	40	10
6650-022	66502-022	22	28	7

• Compatible con tubo de cobre y acero inoxidable
Serie 66 y 67
Compatible with 66 and 67 Series copper and
stainless steel pipe



FICHA TÉCNICA
TECHNICAL SHEET

CÓDIGO CODE _____
MEDIDA SIZE _____
ENCAJADO GRANDE MASTER CARTON _____
ENCAJADO INTERMEDIO INNER CARTON _____

4074 ■

NEW



40742 ■



Válvula esfera PN-30 H-H
tuerca móvil con mando
palomilla color rojo y azul

GOLD

EAN CODE

F-F ball valve PN-30 with
loose nut connector and
butterfly handle red and
blue color

4074-01520	40742-01520	1/2" x 3/4"	60	44
4074-02020	40742-02020	3/4" x 3/4"	60	44

- Con tuerca precintable
With sealeable nut



FICHA TÉCNICA
TECHNICAL SHEET

4174 ■

NEW



41742 ■



Válvula esfera PN-30 M-H
tuerca móvil con mando
palomilla color rojo y azul

GOLD

EAN CODE

M-F ball valve PN-30 with
loose nut connector and
butterfly handle red and
blue color

4174-01520	41742-01520	1/2" x 3/4"	60	44
4174-02020	41742-02020	3/4" x 3/4"	60	44



FICHA TÉCNICA
TECHNICAL SHEET

4182

NEW



Válvula esfera antirretorno
PN16 H-H mando palomilla
color rojo

- Esfera con válvula
antirretorno de POM
incorporada

GOLD

EAN CODE

F-F check ball valve PN-16
butterfly handle red color

- POM check valve inte-
grated in the ball

4182-015	1/2" x 3/4"	60	15
4182-020	3/4" x 3/4"	36	9
4182-025	1" x 1"	24	6



FICHA TÉCNICA
TECHNICAL SHEET

4084

NEW



Válvula esfera antirretorno
PN16 H-H tuerca móvil
mando palomilla color rojo

- Esfera con válvula
antirretorno de POM
incorporada

GOLD

EAN CODE

F-F check ball valve PN-16
with loose nut connector
and butterfly handle red
color

- POM check valve inte-
grated in the ball

4084-01520	1/2" x 3/4"	60	15
4084-02020	3/4" x 3/4"	44	11
4084-02525	1" x 1"	24	6



FICHA TÉCNICA
TECHNICAL SHEET



SILVER SERIES

- Latón CW617N
- Nueva maneta negra ergonómica con recubrimiento de alta resistencia frente a la corrosión.
- -20°C / 120°C
- Brass CW617N
- New ergonomic black handle with high protection coating against corrosion.
- -20°C / 120°C

PN
25

• **Recambios** disponibles en página 220
Spare parts available page 220



CÓDIGO CODE _____
MEDIDA SIZE _____
ENCAJADO GRANDE MASTER CARTON _____
ENCAJADO INTERMEDIO INNER CARTON _____

40912 ■



4091 ■



Válvula esfera PN-25 M-H palanca ergonómica en acero al carbono con recubrimiento anticorrosión

M-F brass ball valve PN-25 ergonomic carbon steel handle with anticorrosion coating

SILVER
ACS PZH
EAN CODE

40912-015	4091-015	1/2"	54	9
40912-020	4091-020	3/4"	42	7
40912-025	4091-025	1"	24	6
40912-032	4091-032	1 1/4"	16	4
40912-040	4091-040	1 1/2"	8	2
40912-050	4091-050	2"	12	2



FICHA TÉCNICA
TECHNICAL SHEET

40922 ■



4092 ■



Válvula esfera PN-25 H-H palanca ergonómica en acero al carbono con recubrimiento anticorrosión

F-F brass ball valve PN-25 ergonomic carbon steel handle with anticorrosion coating

SILVER
ACS PZH
EAN CODE

40922-015	4092-015	1/2"	54	9
40922-020	4092-020	3/4"	42	7
40922-025	4092-025	1"	24	6
40922-032	4092-032	1 1/4"	16	4
40922-040	4092-040	1 1/2"	8	2
40922-050	4092-050	2"	12	2
40922-065*	4092-065*	2 1/2"	12	1
40922-080*	4092-080*	3"	6	1
40922-100*	4092-100*	4"	4	1

- * Próximamente disponible en palanca con recubrimiento anticorrosión
- * Coming soon in handle with anticorrosion coating



FICHA TÉCNICA
TECHNICAL SHEET

40932 ■



4093 ■



Válvula esfera PN-25 H-H mando palomilla

F-F ball valve PN-25 with butterfly handle

SILVER
ACS PZH
EAN CODE

40932-015	4093-015	1/2"	60	10
40932-020	4093-020	3/4"	48	8
40932-025	4093-025	1"	24	6



FICHA TÉCNICA
TECHNICAL SHEET

40942 ■



4094 ■



Válvula esfera PN-25 M-H mando palomilla

M-F ball valve PN-25 with butterfly handle

SILVER
ACS PZH
EAN CODE

40942-015	4094-015	1/2"	60	10
40942-020	4094-020	3/4"	48	8
40942-025	4094-025	1"	24	6



FICHA TÉCNICA
TECHNICAL SHEET



VÁLVULAS ESFERA DE SOLDAR SOLDER BALL VALVES



FICHA TÉCNICA
TECHNICAL SHEET



CÓDIGO CODE _____
MEDIDA SIZE _____
ENCAJADO GRANDE MASTER CARTON _____
ENCAJADO INTERMEDIO INNER CARTON _____

4107



Válvula esfera de soldar
PN-30 palanca en acero
cromado

Solder end ball valve PN-30
with chromed steel handle

EAN CODE

4107-015	15	48	8
4107-018	18	48	8
4107-022	22	36	6
4107-028	28	16	4
4107-035	35	12	2
4107-042	42	12	2

4108



Válvula esfera de soldar
PN-30 mando palomilla

Solder end ball valve PN-30
butterfly handle

EAN CODE

4108-015	15	54	9
4108-018	18	54	9
4108-022	22	42	7
4108-028	28	20	5



VÁLVULAS ESFERA DE EMPOTRAR LONG NECK BALL VALVES

CÓDIGO CODE _____
MEDIDA SIZE _____
ENCAJADO GRANDE MASTER CARTON _____
ENCAJADO INTERMEDIO INNER CARTON _____

4221



Válvula esfera de empotrar
PN-30 terminal soldar
"Carla"

Long neck solder ball valve
PN-30 'Carla' type

- Lado del cuadradillo
8x8mm. en todas las
dimensiones

- Side of square 8x8mm.
in all dimensions

GOLD

EAN CODE

4221-015	15	40	10
4221-018	18	40	10
4221-022	22	32	8

- Mandos disponibles en página 20
Handles available page 20



FICHA TÉCNICA
TECHNICAL SHEET

4222



Válvula esfera de empotrar
H-H PN-30 "Carla" roscar

Long neck ball valve F-F
PN-30 'Carla' type, threaded

- Lado del cuadradillo
8x8mm. en todas las
dimensiones

- Side of square 8x8mm.
in all dimensions

GOLD

EAN CODE

4222-015	1/2"	48	12
4222-020	3/4"	32	8
4222-025	1"	24	6

- Mandos disponibles en página 20
Handles available page 20



FICHA TÉCNICA
TECHNICAL SHEET

4230



Alargadera para válvula
"Carla"

Elongation for 'Carla'
valves

EAN CODE

4230-01	-	1000	25
---------	---	------	----

- Lado del cuadradillo 8x8mm. en todas las dimensiones
Side of square 8x8mm. in all dimensions



FICHA TÉCNICA
TECHNICAL SHEET

42642



Válvula esfera de empotrar
conexión multicapa prensar

Long neck multilayer press
ball valve

GOLD

EAN CODE

42642-016	16 x 2.0	32	8
42642-020	20 x 2.0	32	8
42642-025	25 x 2.5	24	6
42642-026	26 x 3.0	24	6
42642-032	32 x 3.0	12	3

- Mandos disponibles en página 20
Handles available page 20



FICHA TÉCNICA
TECHNICAL SHEET

CÓDIGO CODE _____
 MODELO MODEL _____
 ENCAJADO GRANDE MASTER CARTON _____
 ENCAJADO INTERMEDIO INNER CARTON _____

4224



Maneta y florón para "Carla"

- Maneta para lado del cuadradillo 8x8mm.

EAN CODE

Handle long neck valve m type 'Carla'

- Handle for 8x8mm. side square

4224-01 M 32 8



**FICHA TÉCNICA
TECHNICAL SHEET**

4225



Mando redondo y florón para "Carla"

- Maneta para lado del cuadradillo 8x8mm.

EAN CODE

Handle long neck valves R type 'Carla'

- Handle for 8x8mm. Side square

4225-01 R 32 8



**FICHA TÉCNICA
TECHNICAL SHEET**

4226



Mando oculto y florón para "Carla"

- Maneta para lado del cuadradillo 8x8mm.

EAN CODE

Handle long neck valves 'O' type 'Carla'

- Handle for 8x8mm. Side square

4226-01 0 36 9



**FICHA TÉCNICA
TECHNICAL SHEET**



VÁLVULAS ESFERA MULTICAPA MULTILAYER BALL VALVES

CÓDIGO CODE _____
MEDIDA SIZE _____
ENCAJADO GRANDE MASTER CARTON _____
ENCAJADO INTERMEDIO INNER CARTON _____

40642



Válvula esfera conexión multicapa prensar con palanca de acero inoxidable color rojo

Multilayer press ball valve with red stainless steel handle

GOLD

EAN CODE

40642-016	16 x 2.0	32	8
40642-020	20 x 2.0	32	8
40642-025	25 x 2.5	16	4
40642-026	26 x 3.0	16	4
40642-032	32 x 3.0	16	4



FICHA TÉCNICA
TECHNICAL SHEET

41642



Válvula esfera conexión multicapa prensar con mando palomilla color rojo

Multilayer press ball valve with red butterfly handle

GOLD

EAN CODE

41642-016	16 x 2.0	48	12
41642-020	20 x 2.0	48	12
41642-025	25 x 2.5	28	7
41642-026	26 x 3.0	28	7
41642-032	32 x 3.0	16	4



FICHA TÉCNICA
TECHNICAL SHEET

42642



Válvula esfera de empotrar conexión multicapa prensar

Long neck multilayer press ball valve

GOLD

EAN CODE

42642-016	16 x 2.0	32	8
42642-020	20 x 2.0	32	8
42642-025	25 x 2.5	24	6
42642-026	26 x 3.0	24	6
42642-032	32 x 3.0	12	3

- Mandos disponibles en página 20
Handles available page 20



FICHA TÉCNICA
TECHNICAL SHEET

45642

NEW



Válvula esfera conexión multicapa prensar tuerca móvil con mando palomilla color rojo

Multilayer press ball valve connection loose nut with butterfly red handle

GOLD

EAN CODE

45642-01620	16 x 2.0 x 3/4"	48	12
45642-02020	20 x 2.0 x 3/4"	48	12
45642-02520	25 x 2.5 x 3/4"	32	8
45642-02620	26 x 3.0 x 3/4"	32	8



FICHA TÉCNICA
TECHNICAL SHEET

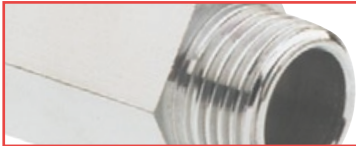

VÁLVULAS ESFERA MINI MINI BALL VALVES

CÓDIGO CODE _____
 MEDIDA SIZE _____
 ENCAJADO GRANDE MASTER CARTON _____
 ENCAJADO INTERMEDIO INNER CARTON _____

4109 ■



41092 ■



Válvula esfera mini
PN-16 H-H mando metálico
color rojo y azul

F-F mini ball valve
PN-16 with red and blue
metal handle

4109-008	41092-008	1/4"	144	24
4109-010	41092-010	3/8"	144	24
4109-015	41092-015	1/2"	108	18

EAN CODE

- Disponibles en acero inoxidable página 41
Available in stainless steel page 41



FICHA TÉCNICA
TECHNICAL SHEET

4110 ■



41102 ■



Válvula esfera mini
PN-16 M-H mando metálico
color rojo y azul

M-F mini ball valve
PN-16 with red and blue
metal handle

4110-008	41102-008	1/4"	144	24
4110-010	41102-010	3/8"	144	24
4110-015	41102-015	1/2"	108	18
4110-020		3/4"	78	13

EAN CODE

- Disponibles en acero inoxidable página 41
Available in stainless steel page 41



FICHA TÉCNICA
TECHNICAL SHEET

41093



Válvula esfera mini
PN-16 H-H mando metálico
color negro

F-F mini ball valve
PN-16 with black metal
handle

41093-008		1/4"	144	24
41093-010		3/8"	144	24
41093-015		1/2"	108	18

EAN CODE



FICHA TÉCNICA
TECHNICAL SHEET

41103



Válvula esfera mini
PN-16 M-H mando metálico
color negro

M-F mini ball valve
PN-16 with black metal
handle

41103-008		1/4"	144	24
41103-010		3/8"	144	24
41103-015		1/2"	108	18
41103-020		3/4"	78	13

EAN CODE



FICHA TÉCNICA
TECHNICAL SHEET



VÁLVULAS DE RETENCIÓN NON RETURN VALVES

CÓDIGO CODE _____
MEDIDA SIZE _____
ENCAJADO GRANDE MASTER CARTON _____
ENCAJADO INTERMEDIO INNER CARTON _____

4114



Válvula de retención pesada con obturador metálico H-H

F-F Non return valve heavy type with metal shutter

- Apto para hidrocarburos cierre NBR

- NBR seal suitable for hydrocarbons

ACS

EAN CODE

4114-015*	1/2"	90	15
4114-020*	3/4"	48	12
4114-025*	1"	36	9
4114-032**	1 1/4"	24	6
4114-040**	1 1/2"	8	2
4114-050**	2"	8	2
4114-065***	2 1/2"	6	1
4114-080***	3"	4	1
4114-100***	4"	3	1

- PN-25*/16**/10***



FICHA TÉCNICA
TECHNICAL SHEET

4115



Válvula de retención ligera con obturador plástico H-H

F-F Non return valve light type with plastic shutter

ACS

EAN CODE

4115-015*	1/2"	120	20
4115-020*	3/4"	90	15
4115-025*	1"	48	8
4115-032**	1 1/4"	24	6
4115-040**	1 1/2"	16	4
4115-050**	2"	8	2

- PN-16*/10**



FICHA TÉCNICA
TECHNICAL SHEET

4215



Válvula de retención ligera con obturador metálico H-H

F-F Non return valve light type with metalic shutter

ACS

EAN CODE

4215-015*	1/2"	144	24
4215-020*	3/4"	90	15
4215-025*	1"	44	11
4215-032**	1 1/4"	24	6
4215-040**	1 1/2"	20	5
4215-050**	2"	8	2
4215-065***	2 1/2"	8	1
4215-080***	3"	3	1
4215-100***	4"	2	1

- PN-16*/10**/8***



FICHA TÉCNICA
TECHNICAL SHEET

CÓDIGO CODE _____
MEDIDA SIZE _____
ENCAJADO GRANDE MASTER CARTON _____
ENCAJADO INTERMEDIO INNER CARTON _____

4116



Filtro válvula de retención
(4114-4115-4215) Filter for non return valve
(4114-4115-4215)

EAN CODE

4116-015	1/2"	140	35
4116-020	3/4"	100	25
4116-025	1"	80	20
4116-032	1 1/4"	36	9
4116-040	1 1/2"	24	6
4116-050	2"	16	4
4116-065	2 1/2"	12	1
4116-080	3"	8	1
4116-100	4"	6	1



FICHA TÉCNICA
TECHNICAL SHEET

4117



Válvula de pie rosca
hembra con filtro Foot valve female thread
with filter

EAN CODE

4117-015*	1/2"	80	20
4117-020*	3/4"	48	12
4117-025*	1"	40	10
4117-032**	1 1/4"	12	3
4117-040**	1 1/2"	12	3
4117-050**	2"	8	1
4117-065***	2 1/2"	4	1
4117-080***	3"	4	1
4117-100***	4"	2	1

• PN-16*/10**/8***



FICHA TÉCNICA
TECHNICAL SHEET

4118



Válvula de fondo rosca
hembra PN-16 Bottom valve female
thread PN-16

- Apto para hidrocarburos
junta NBR
- NBR seal suitable for
hydrocarbons

EAN CODE

4118-015	1/2"	60	15
4118-020	3/4"	48	12
4118-025	1"	48	12
4118-032	1 1/4"	20	5
4118-040	1 1/2"	12	3
4118-050	2"	8	2
4118-065	2 1/2"	8	1
4118-080	3"	4	1
4118-100	4"	2	1



FICHA TÉCNICA
TECHNICAL SHEET

4119



Válvula de clapeta cierre
elástico H-H F-F Rubber washer swing
check valve

ACS

EAN CODE

4119-015*	1/2"	72	12
4119-020*	3/4"	60	10
4119-025*	1"	28	7
4119-032**	1 1/4"	20	5
4119-040**	1 1/2"	16	4
4119-050**	2"	10	1
4119-065***	2 1/2"	5	1
4119-080***	3"	3	1
4119-100***	4"	2	1

PN-16*/ PN-10**/ PN-8***



FICHA TÉCNICA
TECHNICAL SHEET



VÁLVULAS DE ESCUADRA ANGLE VALVES



FICHA TÉCNICA
TECHNICAL SHEET



CÓDIGO CODE _____
MEDIDA SIZE _____
ENCAJADO GRANDE MASTER CARTON _____
ENCAJADO INTERMEDIO INNER CARTON _____

Modelo	Descripción	Medida	Código	Longitud	Altura	
4404 	Válvula de escuadra con filtro Angle ball valve with filter EAN CODE		4404-01510	1/2" x 3/8"	60 15	
			4404-01515	1/2" x 1/2"	60 15	
			4404-01520	1/2" x 3/4"	60 15	
• Longitud 58,5mm Length 58,5mm						
4405 	Válvula de escuadra larga con filtro Long angle valve with filter EAN CODE		4405-01510	1/2" x 3/8"	60 15	
			4405-01515	1/2" x 1/2"	60 15	
			4405-01520	1/2" x 3/4"	60 15	
• Longitud 72mm Length 72mm						
4411 	Válvula de escuadra modelo export Angle ball valve model export EAN CODE		4411-01510	1/2" x 3/8"	60 15	
			4411-01515	1/2" x 1/2"	60 15	
			• Longitud 73,5mm Length 73,5mm			
4402 	Válvula de escuadra Angle valve EAN CODE		4402-01510	1/2" X 3/8"	60 15	
			4402-01515	1/2" X 1/2"	60 15	
			4402-01520	1/2" X 3/4"	60 15	
• Longitud 78mm Length 78mm.						
4422 	Válvula de escuadra antical con mando metálico Anti-lime angle valve with metal handle EAN CODE ANTIHIELO / NOFROST		4422-01510	1/2" X 3/8"	60 15	
			• Longitud 79,5mm Length 79,5mm			
4406 	Válvula de escuadra larga Long angle valve EAN CODE		4406-01510	1/2" X 3/8"	60 15	
			• Longitud 95mm Length 95mm			
4426 	Válvula de escuadra larga antical con mando metálico Anti-lime long angle valve with metal handle EAN CODE ANTICAL / LIME		4426-01510	1/2" X 3/8"	60 15	
			• Longitud 95mm Length 95mm			

CÓDIGO CODE _____
 MEDIDA SIZE _____
 ENCAJADO GRANDE MASTER CARTON _____
 ENCAJADO INTERMEDIO INNER CARTON _____

4409



Válvula de escuadra modelo "Deco" con mando redondo

Angle valve 'Deco' type round handle

EAN CODE

4409-01510	1/2" X 3/8"	45	1
4409-01515	1/2" X 1/2"	45	1

- Cierre cerámico antical
Anti-lime ceramic seal



FICHA TÉCNICA
TECHNICAL SHEET

4410



Válvula de escuadra modelo "Deco" con mando cuadrado

Angle valve 'Deco' type square handle

EAN CODE

4410-01510	1/2" X 3/8"	45	1
4410-01515	1/2" X 1/2"	45	1

- Cierre cerámico antical
Anti-lime ceramic seal



FICHA TÉCNICA
TECHNICAL SHEET



VÁLVULAS DE COMPUERTA GATE VALVES



FICHA TÉCNICA
TECHNICAL SHEET



CÓDIGO CODE _____
MEDIDA SIZE _____
ENCAJADO GRANDE MASTER CARTON _____
ENCAJADO INTERMEDIO INNER CARTON _____

4113



Válvula de compuerta paso estándar H-H PN-10 F-F gate valve standard flow PN-10

ACS

EAN CODE

4113-015*	1/2"	48	12
4113-020*	3/4"	48	12
4113-025*	1"	32	8
4113-032*	1 1/4"	24	4
4113-040*	1 1/2"	12	3
4113-050*	2"	8	2
4113-065**	2 1/2"	4	1
4113-080**	3"	4	1
4113-100*	4"	4	1

• PN-10*/ PN-16**

4113CE



Válvula de compuerta cierre elástico H-H paso estándar F-F gate valve with rubber wedge standard flow

- Compuerta NBR apta para hidrocarburos

- NBR wedge suitable for hydrocarbons

ACS

EAN CODE

4113-015CE*	1/2"	48	12
4113-020CE*	3/4"	30	5
4113-025CE*	1"	16	4
4113-032CE**	1 1/4"	8	2
4113-040CE**	1 1/2"	8	2
4113-050CE**	2"	6	1
4113-065CE*	2 1/2"	4	1
4113-080CE*	3"	4	1
4113-100CE*	4"	4	1

• PN-16*/ PN-10**

4113I



Válvula de compuerta paso total H-H PN-16 F-F gate valve full bore PN-16

ACS

EAN CODE

4113-015I	1/2"	48	12
4113-020I	3/4"	40	10
4113-025I	1"	24	6
4113-032I	1 1/4"	12	3
4113-040I	1 1/2"	8	2
4113-050I	2"	6	1
4113-065I	2 1/2"	4	1
4113-080I	3"	4	1
4113-100I	4"	4	1



VÁLVULAS DE SEGURIDAD Y ANTIGOLPE DE ARIETE SAFETY AND WATER HAMMER DAMPER VALVES

CÓDIGO CODE _____
 MEDIDA SIZE _____
 ENCAJADO GRANDE MASTER CARTON _____
 ENCAJADO INTERMEDIO INNER CARTON _____

4415		Válvula de seguridad de membrana 3 bar EAN CODE	Diaphragm safety valve 3 bar	4415-015	1/2"	100	1
				4415-020	3/4"	90	1
4416		Válvula de seguridad de membrana 7 bar EAN CODE	Diaphragm safety valve 7 bar	4416-015	1/2"	100	1
				4416-020	3/4"	90	1
4413		Válvula de seguridad con palanca 8.5 bar M-H EAN CODE	M-F safety valve for heaters with handle 8.5 Bar	4413-015	1/2"	150	1
4414		Válvula de seguridad pesada con palanca 8.5 bar M-H EAN CODE	M-F safety valve for heaters with handle 8.5 Bar	4414-020	3/4"	100	1
4412		Válvula de seguridad 8.5 bar M-H EAN CODE	M-F safety valve for water heater 8.5 bar	4412-015	1/2"	150	1
				4412-020	3/4"	100	1
4161		Amortiguador golpe de ariete EAN CODE	Water hammer arrester	4161-015	1/2"	20	1
				<ul style="list-style-type: none"> Hasta tubería de 50mm Up to 50mm pipe 			



GRIFOS DE JARDÍN BIBCOCK

CÓDIGO CODE _____
MEDIDA SIZE _____
ENCAJADO GRANDE MASTER CARTON _____
ENCAJADO INTERMEDIO INNER CARTON _____

4125



Grifo esfera jardín pesado PN-16 palanca acero inoxidable color negro con racor manguera
Heavy brass ball bibcock garden PN-16 with stainless steel black handle and hose connector

PLATINUM

ANTIHIELO / NOFROST EAN CODE

4125-01520	1/2" x 3/4"	36	9
4125-02025	3/4" x 1"	16	4
4125-02532	1" x 1 1/4"	12	3



FICHA TÉCNICA
TECHNICAL SHEET

4111

4111G



Grifo esfera jardín PN-16 con racor manguera
Brass ball bibcock garden PN-16 with hose connector

GOLD

ANTIHIELO / NOFROST EAN CODE

4111-01520	1/2" x 3/4"	36	9
4111-01520G	1/2" x 3/4"	12	1
4111-02020	3/4" x 3/4"	32	8
4111-02025	3/4" x 1"	24	6
4111-02025G	3/4" x 1"	12	1
4111-02532	1" x 1 1/4"	12	3



FICHA TÉCNICA
TECHNICAL SHEET

4142



Grifo esfera jardín PN-16 enchufe rápido
Brass ball bibcock garden PN-16 quick female connector

GOLD

ANTIHIELO / NOFROST EAN CODE

4142-01520	1/2" x 3/4"	36	9
4142-02025	3/4" x 1"	24	6
4142-02532	1" x 1 1/4"	12	3



FICHA TÉCNICA
TECHNICAL SHEET

4144



Grifo esfera jardín PN-16 con palanca de acero inoxidable con racor manguera
Brass ball bibcock garden PN-16 with stainless steel handle and hose connector

GOLD

ANTIHIELO / NOFROST EAN CODE

4144-01520	1/2" x 3/4"	36	9
4144-02025	3/4" x 1"	24	6
4144-02532	1" x 1 1/4"	12	3



FICHA TÉCNICA
TECHNICAL SHEET

4123

4123G



Grifo esfera jardín PN-16 palanca acero inoxidable color negro y enchufe rápido
Brass ball bibcock garden PN-16 stainless steel black handle and quick female connector

GOLD

ANTIHIELO / NOFROST EAN CODE

4123-01520	1/2" x 3/4"	36	9
4123-01520G	1/2" x 3/4"	12	1
4123-02025	3/4" x 1"	24	6
4123-02532	1" x 1 1/4"	12	3



FICHA TÉCNICA
TECHNICAL SHEET

CÓDIGO CODE _____
 MEDIDA SIZE _____
 ENCAJADO GRANDE MASTER CARTON _____
 ENCAJADO INTERMEDIO INNER CARTON _____

4147

4147G



Grifo esfera jardín PN-16
palanca cromada con
cierre de seguridad y racor
manguera

Brass ball bibcock garden
PN-16 chrome handle with
locking device and hose
connector

GOLD
ANTIHIELO / NOFROST **EAN CODE**
CIERRE SEGURIDAD / LOCKING DEVICE

4147-01520	1/2" x 3/4"	40	10
4147-01520G	1/2" x 3/4"	12	1
4147-02025	3/4" x 1"	24	6
4147-02532	1" x 1 1/4"	12	3



FICHA TÉCNICA
TECHNICAL SHEET

4146



Grifo esfera jardín PN-16
con racor manguera modelo
export

Brass ball bibcock garden
PN-16 with hose connector
export type

SILVER
ANTIHIELO / NOFROST **EAN CODE**

4146-01520	1/2" x 3/4"	36	9
4146-02020	3/4" x 3/4"	32	8
4146-02025	3/4" x 1"	24	6



FICHA TÉCNICA
TECHNICAL SHEET

4143



Grifo esfera jardín PN-16
con enchufe rápido modelo
export

Brass ball bibcock garden
PN-16 with quick female
connector export type

SILVER
EAN CODE

4143-01520	1/2" x 3/4"	36	9
4143-02025	3/4" x 1"	24	6



FICHA TÉCNICA
TECHNICAL SHEET

4145

4145G



Grifo jardín de latón PN-10
enchufe manguera

Brass bibcock garden
PN-10 hose connector

EAN CODE

4145-01520	1/2" x 3/4"	40	10
4145-01520G	1/2" x 3/4"	20	1
4145-02020	3/4" x 3/4"	24	6
4145-02025	3/4" x 1"	24	6



FICHA TÉCNICA
TECHNICAL SHEET

4148

4148G



Grifo esfera jardín PN-16
dos salidas palanca cromada
con enchufe rápido

Brass ball bibcock garden
two outlets PN-16 chrome
handle with quick female
connector

EAN CODE

4148-0152020	1/2" x 3/4" x 3/4"	32	8
4148-0152020G	1/2" x 3/4" x 3/4"	12	1



FICHA TÉCNICA
TECHNICAL SHEET

4121

4122



Racor hembra enchufe
rápido (4121)

Quick female connector
(4121)

Racor manguera hembra
(4122)

Tap female hose connector
(4122)

EAN CODE

4121-020	3/4"	320	10
4121-025	1"	200	10
4121-032	1 1/4"	100	5
4122-020	3/4"	320	10
4122-025	1"	200	10
4122-032	1 1/4"	100	5



FICHA TÉCNICA
TECHNICAL SHEET



GRIFOS LAVADORA Y BARRIL BARREL AND WASHING MACHINE VALVES



FICHA TÉCNICA
TECHNICAL SHEET



CÓDIGO CODE
MEDIDA SIZE
ENCAJADO GRANDE MASTER CARTON
ENCAJADO INTERMEDIO INNER CARTON

4434		Grifo lavadora simple con mando metálico EAN CODE	Simple washing machine valve with metallic handle	4434-01520	1/2" x 3/4"	32 8
4435		Grifo lavadora doble con mando metálico EAN CODE	Double washing machine valve with metallic handle	4435-0152020	1/2" x 3/4" x 3/4"	20 1
4407		Válvula mixta lavadora lavabo EAN CODE	Washing machine washbasin mixed valve	4407-01520	1/2" X 3/4" X 3/8"	28 7
4400		Grifo lavadora EAN CODE	Washing machine valve	4400-01520	1/2" x 3/4"	60 15
4401		Grifo lavadora tipo "M" EAN CODE	Washing machine valve 'M' type • Longitud 82mm Length 82mm	4401-01520	1/2" x 3/4"	48 12

CÓDIGO CODE _____
MEDIDA SIZE _____
ENCAJADO GRANDE MASTER CARTON _____
ENCAJADO INTERMEDIO INNER CARTON _____

4149



Válvula esfera PN-16
barril palanca aluminio

Barrell ball valve with
aluminium handle PN-16

EAN CODE

4149-010	3/8"	40	10
4149-015	1/2"	40	10
4149-020	3/4"	24	6
4149-025	1"	16	4



FICHA TÉCNICA
TECHNICAL SHEET

4141



Válvula esfera PN-16
barril palomilla

Barrell ball valve PN-16

EAN CODE

4141-01515	1/2" x 1/2"	42	2
4141-02020	3/4" x 3/4"	30	2



FICHA TÉCNICA
TECHNICAL SHEET









REDUCTORAS DE PRESIÓN PRESSURE REDUCING VALVES



FICHA TÉCNICA
TECHNICAL SHEET



CÓDIGO CODE _____
MEDIDA SIZE _____
ENCAJADO GRANDE MASTER CARTON _____
ENCAJADO INTERMEDIO INNER CARTON _____

4150		Reductora de presión "Mignon"	Pressure reducing valve 'Mignon'	4150-015	1/2"	50	1
				4150-020	3/4"	50	1
				<ul style="list-style-type: none"> Presión máxima de entrada 15 Bar / Latón DZR opcional Maximum admission pressure 15 Bar / Optional in brass DZR 			
4151		Reductora de presión DVGW	Pressure reducing valve	4151-015	1/2"	25	1
				4151-020	3/4"	30	1
				4151-025	1"	15	1
				4151-032	1 1/4"	6	1
				4151-040	1 1/2"	6	1
				4151-050	2"	3	1
				4151-065	2 1/2"	3	1
				4151-080	3"	3	1
				<ul style="list-style-type: none"> Presión máxima de entrada 25 Bar / Latón DZR opcional Maximum admission pressure 25 Bar / Optional in brass DZR 			
4152		Reductora de presión con racores DVGW	Pressure reducing valve with records	4152-015	1/2"	20	1
				4152-020	3/4"	10	1
				4152-025	1"	10	1
				4152-032	1 1/4"	6	1
				4152-040	1 1/2"	6	1
				4152-050	2"	3	1
4153		Reductora de presión con bridas	Pressure reducing valve flanged ends	4153-050	2"	2	1
				4153-065	2 1/2"	2	1
				<ul style="list-style-type: none"> Presión máxima de entrada 25 Bar / Latón DZR opcional Maximum admission pressure 25 Bar / Optional in brass DZR 			
4154		Reductora de presión con graduación	Pressure reducing valve with graduated setting	4154-015	1/2"	15	1
				4154-020	3/4"	15	1
				4154-025	1"	10	1
				<ul style="list-style-type: none"> Presión máxima de entrada 25 Bar Maximum admission pressure 25 Bar 			
4155		Reductora de presión con racors y graduación	Pressure reducing valve with records and graduated settings	4155-015	1/2"	15	1
				4155-020	3/4"	10	1
				4155-025	1"	10	1
				<ul style="list-style-type: none"> Presión máxima de entrada 25 Bar Maximum admission pressure 25 Bar 			



DESFANGADOR Y FILTRO MAGNÉTICO MAGNETIC DIRT SEPARATOR STRAINER

CÓDIGO CODE _____
MEDIDA SIZE _____
ENCAJADO GRANDE MASTER CARTON _____
ENCAJADO INTERMEDIO INNER CARTON _____

4156



Filtro magnético

- Elimina las impurezas de los circuitos. El imán que incorpora retiene las impurezas férricas.
- Tamiz filtrante de 1000 micras (1mm)
- Imán extraíble de 3.000 Gauss
- Roscas hembra según ISO 228
- Fácil desmontaje del tamiz para su limpieza con junta de PTFE
- Presión máxima de trabajo: 10 Bar
- Temperatura de funcionamiento de 130°C

También para instalaciones de suministro de agua.

Magnetic strainer

- Removes impurities from the circuits. The incorporating magnet retains the iron impurities.
- Filter sieve 1000 microns (1mm)
- 3.000 Gauss removable magnet
- Female threads according to ISO 228
- Easy disassembly of the sieve for cleaning with PTFE gasket.
- Max. working pressure: 10 Bar
- Operating temperature of 130°C

Also water supply facilities.

4156-020	3/4"	25	1
4156-025	1"	25	1



FICHA TÉCNICA
TECHNICAL SHEET

4157



Filtro desfangador magnético

- Separa y elimina las impurezas de los circuitos cerrados. el imán que incorpora retiene las impurezas férricas.
- Tamiz filtrante de 800 micras (0.8mm)
- Imán extraíble de 12.000 Gauss
- Válvula M-H de 3/4", enlace 3/4" (racor loco) y tapón 3/4" en latón
- Roscas hembra según ISO 228
- Fácil desmontaje del tamiz para su limpieza con junta de PTFE
- Presión máxima de trabajo: 10 Bar
- Temperatura de funcionamiento de 110°C
- Ideal para instalación en lugares con limitaciones de espacio.
- Con la instalación de una válvula en el tapón se puede limpiar las impurezas del desfangador sin parar el circuito.

Magnetic dirt separator strainer

- Separates and removes impurities from closed circuits. The incorporating magnet retains the iron impurities.
- Filter sieve 800 microns (0.8mm)
- 12.000 Gauss removable magnet
- M "M-H valve, 3/4" link (crazy fitting) and brass 3/4" plug
- Female threads according to ISO 228
- Easy disassembly of the sieve for cleaning with PTFE gasket.
- Max. working pressure: 10 Bar
- Operating temperature of 110°C
- Ideal for installation in places with space limitations.
- With the installation of a valve in the cap, the impurities of the defroster can be cleaned without stopping the circuit.

4157-020	3/4"	5	1
----------	------	---	---



FICHA TÉCNICA
TECHNICAL SHEET



FILTROS FILTERS

CÓDIGO CODE _____
MEDIDA SIZE _____
ENCAJADO GRANDE MASTER CARTON _____
ENCAJADO INTERMEDIO INNER CARTON _____

4120



Filtro Y tamiz inoxidable
H-H PN-16

F-F Y Strainer with stain-
less steel sieve PN-16

ACS

EAN CODE

4120-015	1/2"	96	24
4120-020	3/4"	48	12
4120-025	1"	36	9
4120-032	1 1/4"	16	4
4120-040	1 1/2"	12	2
4120-050	2"	9	1

• Disponible en acero inoxidable página 47
Available in stainless steel page 47

• **Recambio** disponible en página 220
Spare part available page 220



FICHA TÉCNICA
TECHNICAL SHEET

4160



Filtro y dispositivo anti-
reflujo (tamiz de 100µ)

Filters and backflow
preventer (100µ)

EAN CODE

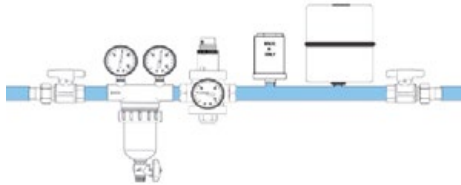

4160-015	1/2"	10	1
4160-020	3/4"	10	1
4160-025	1"	6	1
4160-032	1 1/4"	6	1
4160-040	1 1/2"	6	1
4160-050	2"	6	1



FICHA TÉCNICA
TECHNICAL SHEET

1

VÁLVULAS Y FILTROS

VALVES AND FILTERS



1

VÁLVULAS Y FILTROS

VALVES AND FILTERS

1.2

ACERO INOXIDABLE

STAINLESS STEEL

Aplicaciones

Instalaciones de agua fría y caliente, vapor baja presión, instalaciones químicas, disolventes, fluidos de todo tipo y aire. Industrias químicas, industrias petroquímicas, industrias alimentarias para proceso externas y auxiliares. Conducción de fluidos, calderas, intercambiadores de calor.

Applications

Installations of cold and hot water, low pressure steam, chemical installations, solvents, fluids and air. Chemical industries, petrochemical industries, food industries for external and auxiliary process. Fluid conduction, boilers, heat exchangers.

Rango de temperatura °C
Temperature range °C

 -20°
180°

Calidad

AISI 316/316L
WCB - Acero al carbono
Paso total o reducido

Quality

AISI 316/316L
WCB - Carbon steel
Full bore or reduced bore



Acero inoxidable CF8M (AISI-316)
Stainless steel CF8M (AISI-316)

VÁLVULAS Y FILTROS DE ACERO INOXIDABLE

STAINLESS STEEL VALVES AND FILTERS

Válvulas esfera Ball valves	38
Grifos Bibcock	44
Válvulas de retención Non return valves	45
Válvulas de compuerta Gate valves	46
Filtros Filters	47

Producto 0912

Válvula esfera tres piezas
roscar paso total pletina
ISO de acero inoxidable
(p.39)

Product 0912

Three pieces ball valve
threaded end full bore, top
flange ISO (p.39)



VÁLVULAS ESFERA BALL VALVES

CÓDIGO CODE _____
 MEDIDA SIZE _____
 ENCAJADO GRANDE MASTER CARTON _____
 ENCAJADO INTERMEDIO INNER CARTON _____

0909



Válvula esfera una pieza
roscar paso reducido BSP

- Cuerpo y bola acero inoxidable CF8M (AISI-316)
- Asientos bola en PTFE
- Roscas H-H BSP s/ norma ISO 7-1
- Presión máxima de trabajo: 63 Bar (1000 psi)
- Temperatura de trabajo: -20°C / 180°C
- Paso reducido

Ball valve one piece thread-
end reduced bore BSP

- Body and ball made of stainless steel CF8M (AISI-316)
- PTFE ball seats
- F-F BSP Threads ISO 7-1
- Max. working pressure: 63 Bar (1000 psi)
- Working temperature: -20°C / 180°C
- Reduced bore

0909-008	1/4"	100	50
0909-010	3/8"	60	30
0909-015	1/2"	50	25
0909-020	3/4"	36	18
0909-025	1"	24	12



FICHA TÉCNICA
TECHNICAL SHEET

09102

0910



Válvula de dos piezas
roscar H-H

- Cuerpo y bola acero inoxidable CF8M (AISI-316)
- Asientos bola en PTFE
- Roscas H-H BSP s/ norma ISO 7/1
- Presión máxima de trabajo: 63 Bar (1000 psi)
- Temperatura de trabajo: -20°C / 180°C
- Paso total

F-F Ball valve two pieces
threaded end full bore

- Body and ball made of stainless steel CF8M (AISI-316)
- PTFE ball seats
- F-F BSP Threads ISO 7/1
- Max. Working pressure: 63 Bar (1000 psi)
- Working temperature: -20°C / 180°C
- Full bore

09102-008	0910-008	1/4"	48	24
09102-010	0910-010	3/8"	48	24
09102-015	0910-015	1/2"	32	16
09102-020	0910-020	3/4"	24	12
09102-025	0910-025	1"	16	8
09102-032	0910-032	1 1/4"	10	1
09102-040	0910-040	1 1/2"	10	1
09102-050	0910-050	2"	6	1
09102-065	0910-065	2 1/2"	4	1
09102-080	0910-080	3"	3	1



FICHA TÉCNICA
TECHNICAL SHEET

09104

09103



Válvula de dos piezas
roscar M-H

- Cuerpo y bola acero inoxidable CF8M (AISI-316)
- Asientos bola en PTFE
- Roscas M-H BSP s/ norma ISO 7/1
- Presión máxima de trabajo: 63 Bar (1000 psi)
- Temperatura de trabajo: -20°C / 180°C
- Paso total

M-F Ball valve two pieces
threaded end full bore

- Body and ball made of stainless steel CF8M (AISI-316)
- PTFE ball seats
- M-F BSP threads ISO 7/1
- Max. working pressure: 1000 psi wog (PN-63)
- Working temperature: -20°C / 180°C
- Full bore

09104-008	09103-008	1/4"	48	24
09104-010	09103-010	3/8"	48	24
09104-015	09103-015	1/2"	32	16
09104-020	09103-020	3/4"	24	12
09104-025	09103-025	1"	16	8
09104-032	09103-032	1 1/4"	10	1
09104-040	09103-040	1 1/2"	10	1
09104-050	09103-050	2"	3	1
09104-065	09103-065	2 1/2"	4	1
09104-080	09103-080	3"	3	1
09104-100	09103-100	4"	2	1



FICHA TÉCNICA
TECHNICAL SHEET

CÓDIGO CODE _____
MEDIDA SIZE _____
ENCAJADO GRANDE MASTER CARTON _____
ENCAJADO INTERMEDIO INNER CARTON _____

0917



Válvula esfera dos piezas roscar plataforma de montaje

- Cuerpo y bola acero inoxidable CF8M (AISI-316)
- Asientos bola en PTFE
- Roscas H-H BSP s/ norma ISO 228 (DIN 259)
- Plataforma montaje directo ISO 5211
- Presión máxima de trabajo: 63 Bar (1000 psi)
- Temperatura de trabajo: -20°C / 180°C
- Paso total

Ball valve two pieces with mounting pad full bore threaded end

- Body and ball made of stainless steel CF8M (AISI-316)
- PTFE ball seats
- F-F BSP Threads ISO 228 (DIN 259)
- Direct mounting Pad ISO 5211
- Max. Working pressure: 63 Bar (1000 psi)
- Working temperature: -20°C / 180°C
- Full bore

0917-008	1/4"	80	40
0917-010	3/8"	80	40
0917-015	1/2"	24	12
0917-020	3/4"	20	10
0917-025	1"	12	6
0917-032	1 1/4"	10	5
0917-040	1 1/2"	4	2
0917-050	2"	3	1

• Para automatización, consultar capítulo 3
See automation valves on chapter 3



FICHA TÉCNICA
TECHNICAL SHEET

0911



Válvula esfera de tres piezas paso total

- Cuerpo fabricado en acero inoxidable CF8M (AISI-316)
- Bola fabricada en acero inoxidable CF8M (AISI-316)
- Asientos bola en PTFE reforzado
- Roscas H-H BSP s/ norma ISO 228/1 (DIN 259)
- Paso total
- Presión máxima de trabajo: 63 Bar (1000 psi)
- Temperatura de trabajo: -20°C / 180°C

Three pieces stainless steel ball valve

- Body made of stainless steel CF8M (AISI-316)
- CF8M (AISI-316) stainless steel ball
- Reinforced PTFE ball seats
- F-F BSP Threads ISO 228/1 (DIN 259)
- Full bore
- Max. Working pressure: 63 Bar (1000 psi)
- Working temperature: -20°C / 180°C

0911-008	1/4"	36	18
0911-010	3/8"	36	18
0911-015	1/2"	20	10
0911-020	3/4"	16	8
0911-025	1"	16	8
0911-032	1 1/4"	8	1
0911-040	1 1/2"	6	1
0911-050	2"	3	1
0911-065	2 1/2"	3	1
0911-080	3"	2	1
0911-100	4"	2	1



FICHA TÉCNICA
TECHNICAL SHEET

0912



Válvula esfera tres piezas roscar paso total pletina ISO

- Cuerpo fabricado en acero inoxidable CF8M (AISI-316)
- Bola fabricada en acero inoxidable CF8M (AISI-316)
- Asientos bola en PTFE reforzado
- Roscas H-H BSP s/ norma ISO 228/1 (DIN 2599)
- Plataforma montaje directo ISO 5211
- Paso total
- Presión máxima de trabajo: 63-40 Bar (1000-600 psi)
- Temperatura de trabajo: -20°C / 180°C

Three pieces ball valve threaded end full bore, top flange ISO

- Body made of stainless steel CF8M (AISI-316)
- CF8M (AISI-316) stainless steel ball
- Reinforced PTFE ball seats
- F-F BSP Threads ISO 228/1 (DIN 2599)
- Direct mounting Pad ISO 5211
- Full bore
- Max. working pressure: 63-40 Bar (1000-600 psi)
- Working temperature: -20°C / 180°C

0912-008*	1/4"	16	8
0912-010*	3/8"	16	8
0912-015*	1/2"	16	8
0912-020*	3/4"	16	8
0912-025*	1"	8	4
0912-032*	1 1/4"	6	1
0912-040*	1 1/2"	4	1
0912-050**	2"	3	1
0912-065**	2 1/2"	3	1
0912-080**	3"	2	1
0912-100**	4"	1	1

* 63 bar - 1000 psi
** 40 bar - 600 psi

• Para automatización, consultar capítulo 3
See automation valves on chapter 3



FICHA TÉCNICA
TECHNICAL SHEET

CÓDIGO CODE _____
MEDIDA SIZE _____
ENCAJADO GRANDE MASTER CARTON _____
ENCAJADO INTERMEDIO INNER CARTON _____

91020



Válvula esfera tres piezas
Butt Weld paso total ple-
tina ISO

- Cuerpo y bola acero inoxidable CF8M (AISI-316)
- Asientos bola en PTFE reforzado
- Plataforma montaje directo ISO5211
- Presión máxima de trabajo: 63-40 Bar (1000-600 psi)
- Temperatura de trabajo: -20°C / 180°C
- Paso total

Three pieces ball valve Butt
Weld full bore mounting
pad ISO

- Body and ball made of stainless steel CF8M (AISI-316)
- Reinforced PTFE ball seats
- Direct mounting Pad ISO 5211
- Max. working pressure: 63-40 Bar (1000-600 psi)
- Working temperature: -20°C / 180°C
- Full bore

91020-015*	1/2"	16	8
91020-020*	3/4"	16	8
91020-025*	1"	8	4
91020-032*	1 1/4"	6	1
91020-040*	1 1/2"	4	1
91020-050**	2"	3	1
91020-065**	2 1/2"	3	1

- * 63 bar - 1000 psi
- ** 40 bar - 600 psi

• Para automatización, consultar capítulo 3
See automation valves on chapter 3



FICHA TÉCNICA
TECHNICAL SHEET

91120



Válvula esfera tres piezas
Socket Weld paso total
pletina ISO

- Cuerpo y bola acero inoxidable CF8M (AISI-316)
- Asientos bola en PTFE reforzado
- Plataforma montaje directo ISO5211
- Presión máxima de trabajo: 63-40 Bar (1000-600 psi)
- Temperatura de trabajo: -20° / 180°C
- Paso total

Three pieces ball valve
Socket Weld full bore
mounting pad ISO

- Body and ball made of stainless steel CF8M (AISI-316)
- Reinforced PTFE ball seats
- Direct mounting Pad ISO 5211
- Max. Working pressure: 63-40 Bar (1000-600 psi)
- Working temperature: -20° / 180°C
- Full bore

91120-015*	1/2"	16	8
91120-020*	3/4"	16	8
91120-025*	1"	8	4
91120-032*	1 1/4"	6	1
91120-040*	1 1/2"	4	1
91120-050**	2"	3	1
91120-065**	2 1/2"	3	1
91120-080**	3"	2	1
91120-100**	4"	1	1

- * 63 bar - 1000 psi
- ** 40 bar - 600 psi

• Para automatización, consultar capítulo 3
See automation valves on chapter 3



FICHA TÉCNICA
TECHNICAL SHEET

0918



Válvula esfera tres vías
pletina ISO paso en L

- Cuerpo fabricado en acero inoxidable CF8M (AISI-316)
- Bola fabricada en acero inoxidable CF8M (AISI-316)
- Asientos bola en PTFE
- Roscas H-H BSP s/ norma ISO 228 (DIN 259)
- Esfera con paso en L
- Plataforma de montaje ISO5211
- Presión máxima de trabajo: 63 Bar (1000 psi)
- Temperatura de trabajo: -20°C / 180°C
- Paso reducido

Three way ball valve L-type
with mounting pad ISO

- Body made of stainless steel CF8M (AISI-316)
- CF8M (AISI-316) stainless steel ball
- PTFE ball seats
- F-F BSP Threads ISO 228 (DIN 259)
- L-Type bore ball
- Direct mounting pad ISO5211
- Max. working pressure: 63 Bar (1000 psi)
- Working temperature: -20°C / 180°C
- Reduced bore

0918-008	1/4"	8	4
0918-010	3/8"	8	4
0918-015	1/2"	8	4
0918-020	3/4"	8	4
0918-025	1"	4	2
0918-032	1 1/4"	5	1
0918-040	1 1/2"	3	1
0918-050	2"	2	1

• Para automatización, consultar capítulo 3
See automation valves on chapter 3



FICHA TÉCNICA
TECHNICAL SHEET

0919



Válvula esfera tres vías
pletina ISO paso en T

Three way ball valve t-type
with mounting pad ISO

- Cuerpo fabricado en acero inoxidable CF8M (AISI-316)
- Bola fabricada en acero inoxidable CF8M (AISI-316)
- Asientos bola en PTFE
- Roscas H-H BSP s/ norma ISO 228 (DIN 259)
- Esfera con paso en T
- Plataforma de montaje ISO5211
- Presión máxima de trabajo: 63 Bar (1000 psi)
- Temperatura de trabajo: -20°C / 180°C
- Paso reducido

- Body made of stainless steel CF8M (AISI-316)
- CF8M (AISI-316) stainless steel ball
- PTFE ball seats
- F-F BSP Threads ISO 228 (DIN 259)
- T-Type bore ball
- Direct mounting pad ISO5211
- Max. working pressure: 63 Bar (1000 psi)
- Working temperature: -20°C / 180°C
- Reduced bore

0919-008	1/4"	8	4
0919-010	3/8"	8	4
0919-015	1/2"	8	4
0919-020	3/4"	8	4
0919-025	1"	4	2
0919-032	1 1/4"	5	1
0919-040	1 1/2"	3	1
0919-050	2"	2	1

• Para automatización, consultar capítulo 3
See automation valves on chapter 3



FICHA TÉCNICA
TECHNICAL SHEET

09142



0914



Válvula esfera mini paso
reducido PN-63 H-H

F-F Reduced bore ball valve
PN-63

- Cuerpo fabricado en acero inoxidable CF8M (AISI-316)
- Bola fabricada en acero inoxidable CF8M (AISI-316)
- Asientos bola en PTFE
- Rosca S/ ISO 7-1
- Presión máxima de trabajo: 63 Bar (PN-63)
- Temperatura de trabajo: -20°C / 180°C

- Body made of stainless steel CF8M (AISI-316)
- CF8M (AISI-316) stainless steel ball
- PTFE ball seats
- Thread according to ISO 7-1
- Max. working pressure: 63 Bar (PN-63)
- Working temperature: -20°C / 180°C

09142-008	0914-008	1/4"	120	60
09142-010	0914-010	3/8"	120	60
09142-015	0914-015	1/2"	100	50

• Disponibles en latón página 22
Available in brass page 22



FICHA TÉCNICA
TECHNICAL SHEET

09152



0915



Válvula esfera mini paso
reducido PN-63 M-H

M-F Reduced bore ball
valve PN-63

- Cuerpo fabricado en acero inoxidable CF8M (AISI-316)
- Bola fabricada en acero inoxidable CF8M (AISI-316)
- Asientos bola en PTFE
- Rosca S/ ISO 7-1
- Presión máxima de trabajo: 63 Bar (PN-63)
- Temperatura de trabajo: -20°C / 180°C

- Body made of stainless steel CF8M (AISI-316)
- CF8M (AISI-316) stainless steel ball
- PTFE ball seats
- Thread according to ISO 7-1
- Max. working pressure: 63 Bar (PN-63)
- Working temperature: -20°C / 180°C

09152-008	0915-008	1/4"	120	60
09152-010	0915-010	3/8"	120	60
09152-015	0915-015	1/2"	100	50

• Disponibles en latón página 22
Available in brass page 22



FICHA TÉCNICA
TECHNICAL SHEET

CÓDIGO CODE _____
MEDIDA SIZE _____
ENCAJADO GRANDE MASTER CARTON _____
ENCAJADO INTERMEDIO INNER CARTON _____

5128



Válvula esfera dos piezas
inoxidable brida

ATEX

- Cuerpo en acero inoxidable CF8M (AISI-316)
- Bola en acero inoxidable CF8M (AISI-316)
- Asientos de bola de PTFE + grafito
- Juntas en PTFE + grafito
- Diseño S/ DIN 3202 con dispositivo de protección contra incendios
- Juntas tóricas eje FKM
- Bridas EN-1092 PN-16
- Presión máxima de trabajo: 16 Bar
- Temperatura de trabajo: -20°C / 180°C
- Paso total
- Certificado ATEX

Two pieces ball valve stain-
less steel flanged end

- Body made of stainless steel CF8M (AISI-316)
- CF8M (AISI-316) stain-
less steel ball
- Ball seats PTFE +
graphite
- PTFE + graphite seat
gaskets
- Design to DIN 3202 with
fire safe system
- FKM stem O-rings
- Flanges EN-1092-2
PN-16
- Max. pressure: 16 bar
- Working temperature:
-20°C / 180°C
- Full bore
- ATEX certificate

5128-015*	1/2"	18	-
5128-020*	3/4"	15	-
5128-025*	1"	1	-
5128-032*	1 1/4"	1	-
5128-040*	1 1/2"	1	-
5128-050**	2"	1	-
5128-065**	2 1/2"	1	-
5128-080**	3"	1	-
5128-100**	4"	1	-
5128-125**	5"	1	-
5128-150**	6"	1	-
5128-200**	8"	1	-

PN-40*/16** (bridas flanges)

- Para automatización, consultar capítulo 3
See automation valves on chapter 3



FICHA TÉCNICA
TECHNICAL SHEET

5117



Válvula esfera dos piezas
acero al carbono con bridas

- Cuerpo fabricado en acero al carbono (A-276 WCB)
- Bola fabricada en acero inoxidable
- Asientos de bola de PTFE reforzado con grafito
- Juntas tóricas eje FKM
- Bridas s/ UNE EN-1092-2 PN-16
- Presión máxima de trabajo: 16 Bar
- Temperatura de trabajo: -20°C / 180°C
- Paso total

Two pieces ball valve WCB
flanged end

- Body made of carbon steel (A-276 WCB)
- Stainless steel ball
- Ball seats made of reinforced PTFE with graphite
- FKM stem O-rings
- Flanges according to UNE EN-1092-2 PN-16
- Max. working pressure: 16 Bar
- Working temperature: -20°C / 180°C
- Full bore

5117-015*	1/2"	18	-
5117-020*	3/4"	15	-
5117-025*	1"	1	-
5117-032*	1 1/4"	1	-
5117-040*	1 1/2"	1	-
5117-050**	2"	1	-
5117-065**	2 1/2"	1	-
5117-080**	3"	1	-
5117-100**	4"	1	-
5117-125**	5"	1	-
5117-150**	6"	1	-

PN-40*/16** (bridas flanges)

- Para automatización, consultar capítulo 3
See automation valves on chapter 3



FICHA TÉCNICA
TECHNICAL SHEET

CÓDIGO CODE
MEDIDA SIZE

ENCAJADO GRANDE MASTER CARTON
ENCAJADO INTERMEDIO INNER CARTON

91031



Válvula esfera wafer paso total con pletina ISO

- Cuerpo y bola acero inoxidable CF8M (AISI-316)
- Asientos bola en PTFE
- Juntas tóricas de FKM
- Brida EN-1092
- Plataforma de montaje ISO 5211
- Presión máxima de trabajo: 16 Bar
- Temperatura de trabajo: -20°C / 180°C

Wafer full bore ball valve with mounting pad ISO

- Body and ball made of stainless steel CF8M (AISI-316)
- PTFE ball seats
- FKM O-rings
- EN-1092 flanges
- Direct mounting pad ISO 5211
- Max. working pressure: 16 Bar
- Working temperature: -20°C / 180°C

91031-015	1/2"	18	9
91031-020	3/4"	14	7
91031-025	1"	12	6
91031-032	1 1/4"	6	3
91031-040	1 1/2"	1	1
91031-050	2"	1	1
91031-065	2 1/2"	1	1
91031-080	3"	1	1
91031-100	4"	1	1

• Para automatización, consultar capítulo 3
See automation valves on chapter 3



FICHA TÉCNICA
TECHNICAL SHEET

91032



Válvula esfera wafer paso total con pletina ISO con cámara calefacción

- Cuerpo y bola acero inoxidable CF8M (AISI-316)
- Asientos bola en PTFE
- Juntas tóricas de FKM
- Cámara de calefacción INOX. (AISI-316)
- Tomas 3/4" hembra
- Brida EN-1092
- Plataforma de montaje ISO 5211
- Presión máxima de trabajo: 16 Bar
- Temperatura de trabajo: -20°C / 180°C

Wafer full bore ball valve with mounting pad ISO and heat chamber

- Body and ball made of stainless steel CF8M (AISI-316)
- PTFE ball seats
- FKM O-rings
- Heat chamber of S.S. (AISI-316)
- Head threads 3/4" female
- EN-1092 flanges
- Direct mounting pad ISO 5211
- Max. working pressure: 16 Bar
- Working temperature: -20°C / 180°C

91032-015	1/2"	1	1
91032-020	3/4"	1	1
91032-025	1"	1	1
91032-032	1 1/4"	1	1
91032-040	1 1/2"	1	1
91032-050	2"	1	1
91032-065	2 1/2"	1	1
91032-080	3"	1	1
91032-100	4"	1	1

• Para automatización, consultar capítulo 3
See automation valves on chapter 3



FICHA TÉCNICA
TECHNICAL SHEET



GRIFOS BIBCOCK

CÓDIGO CODE _____
 MEDIDA SIZE _____
 ENCAJADO GRANDE MASTER CARTON _____
 ENCAJADO INTERMEDIO INNER CARTON _____

0926



Válvula barril para depósito

- Cuerpo y maneta en acero inoxidable AISI-316
- Asientos en PTFE
- Tuerca para soldar incluida
- Presión máxima de trabajo: 6 Bar (100 psi)
- Temperatura de trabajo: -20°C /180°C

Barrel ball valve

- Body and handle made of stainless steel AISI-316
- PTFE seats
- Welding nut included
- Max. working pressure: 6 Bar (100 psi)
- Working temperature: -20°C /180°C

0926-008	1/4"	100	50
----------	------	-----	----



FICHA TÉCNICA
TECHNICAL SHEET

0921



0921G



Grifo esfera jardín enchufe manguera PN-16 inoxidable

EAN CODE

- Cuerpo, tapa, bola y conexión manguera en acero inoxidable AISI-316
- Maneta y mecanismo de bloqueo en AISI-304
- Asientos bola en PTFE
- Rosca s/ ISO 228/1 (DIN 259)
- Presión máxima de trabajo: 16 Bar
- Temperatura de trabajo: -10°C /100°C

Stainless steel bib cock garden PN-16 hose connector

- Body, bonnet, ball and hose connection made of stainless steel AISI-316
- Handle and lock device made of stainless steel AISI-304
- PTFE ball seats
- Thread according to ISO 228/1 (DIN259)
- Max. working pressure: 16 Bar
- Working temperature: -10°C / 100°C

0921-015	1/2" x 3/4"	30	15
0921-015G	1/2" x 3/4"	12	1
0921-020	3/4" x 3/4"	20	10
0921-025	1" x 1"	10	5



FICHA TÉCNICA
TECHNICAL SHEET



VÁLVULAS DE RETENCIÓN NON RETURN VALVES

CÓDIGO CODE _____

MEDIDA SIZE _____

ENCAJADO GRANDE MASTER CARTON _____

ENCAJADO INTERMEDIO INNER CARTON _____

0916



Válvula de retención dos piezas

- Cuerpo, tapa y disco fabricado en acero inoxidable CF8M (AISI-316)
- Junta cierre en PTFE
- Asiento en FKM
- Roscas s/ norma ISO 7/1
- Presión mínima de apertura: 0,5 Bar
- Presión máxima de trabajo: 16 Bar
- Temperatura de trabajo: -20°C / 180°C

Two pieces spring vertical check valve

- Body, cap and press cap made of stainless steel CF8M (AISI-316)
- PTFE gasket
- FKM seat
- Thread ends according to ISO 7/1
- Minimum pressure to open: 0,5 Bar
- Max. working pressure: 16 Bar
- Working temperature: -20°C / 180°C

0916-008	1/4"	100	50
0916-010	3/8"	100	50
0916-015	1/2"	70	35
0916-020	3/4"	54	27
0916-025	1"	34	17
0916-032	1 1/4"	20	10
0916-040	1 1/2"	20	10
0916-050	2"	12	6
0916-065	2 1/2"	7	1
0916-080	3"	6	1
0916-100	4"	3	1



FICHA TÉCNICA
TECHNICAL SHEET

5118



Válvula de retención disco PN-40

- Fabricada completamente en inoxidable CF8M (AISI-316)
- Bridas s/ norma DIN 2501 / EN-1092:1 PN-40
- Cara a cara s/ norma DIN 3202-1999 K4
- Presión máxima de trabajo: 40 Bar
- Temperatura de trabajo: -20°C / 300°C
- Paso reducido

Disc check valve PN-40

- Made completely of stainless steel CF8M (AISI-316)
- Flanges according to DIN 2501 / EN-1092:1 PN-40
- Face to face according to DIN 3202-1999 K4
- Max. working pressure: 40 Bar
- Working temperature: -20°C / 300°C
- Reduced bore

5118-015	1/2"	1	-
5118-020	3/4"	1	-
5118-025	1"	1	-
5118-032	1 1/4"	1	-
5118-040	1 1/2"	1	-
5118-050	2"	1	-
5118-065	2 1/2"	1	-
5118-080	3"	1	-
5118-100	4"	1	-



FICHA TÉCNICA
TECHNICAL SHEET

5119



Válvula de retención clapeta oscilante tipo wafer

- Cuerpo y disco inoxidable 316 (AISI-316)
- Juntas de FKM
- Bridas s/ norma EN-1092 PN-10/16 (DIN-2501/2502)
- Presión máxima de trabajo: 16 Bar
- Temperatura de trabajo: -20°C / 180°C
- Paso reducido

Thin wafer swing check valve

- Body and disc made of stainless steel 316 (AISI-316)
- FKM O-Rings
- Flanges according to EN-1092 PN-10/16 (DIN-2501/2502)
- Max. working pressure: 16 Bar
- Working temperature: -20°C / 180°C
- Reduced bore

5119-040	1 1/2"	1	1
5119-050	2"	1	1
5119-065	2 1/2"	1	1
5119-080	3"	1	1
5119-100	4"	1	1
5119-125	5"	1	1
5119-150	6"	1	1



FICHA TÉCNICA
TECHNICAL SHEET



VÁLVULAS DE COMPUERTA GATE VALVES

CÓDIGO CODE _____
MEDIDA SIZE _____
ENCAJADO GRANDE MASTER CARTON _____

5132



Válvula de compuerta inoxi-
dable cierre metálico

- Fabricado en acero inoxidable (AISI-316)
- Compuerta metálica INOX AISI-316
- Eje de acero inoxidable (AISI-316)
- Bridas s/ UNE EN1092-2 PN-16
- Presión máxima de trabajo: 16 Bar
- Temperatura de trabajo: -20°C / 200°

Metallic gate valve stain-
less steel

- Made of stainless steel (AISI-316)
- Stainless steel wedge AISI-316
- Stainless steel stem (AISI-316)
- Flanges according to UNE EN1092-2 PN-16
- Max. working pressure: 16 Bar
- Working temperature: -20°C / 200°C

5132-040	1 1/2"	1
5132-050	2"	1
5132-065	2 1/2"	1
5132-080	3"	1
5132-100	4"	1
5132-125	5"	1
5132-150	6"	1
5132-200	8"	1

- Bajo consulta
On request



FICHA TÉCNICA
TECHNICAL SHEET

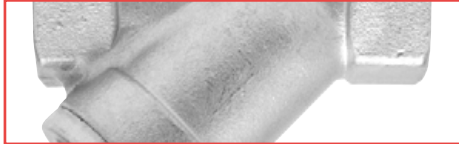

FILTROS FILTERS

CÓDIGO CODE _____
 MEDIDA SIZE _____
 ENCAJADO GRANDE MASTER CARTON _____
 ENCAJADO INTERMEDIO INNER CARTON _____

0913

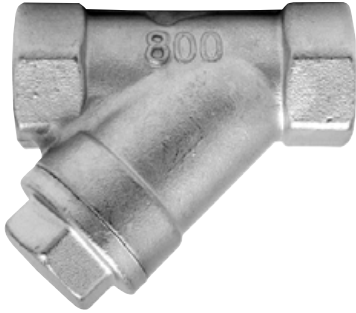

Filtro A-316 Y tamiz inoxidable conexión H-H

- Fabricado en inoxidable CF8M (AISI-316)
- Junta plana de PTFE
- Grado de filtración: 1mm.
- Roscas s/ norma ISO 7/1 (DIN 2999/BS 21)
- Presión máxima de trabajo: 40 Bar
- Temperatura de trabajo: -20°C / 180°C

F-F stainless steel A-316 Y strainer filter

- Made of stainless steel CF8M (AISI-316)
- Flat PTFE gasket
- Filtration degree: 1mm.
- F-F threads according to ISO 7/1 (DIN 2999/BS 21)
- Max. working pressure: 40 Bar
- Working temperature: -20°C / 180°C

0913-008	1/4"	70	35
0913-010	3/8"	70	35
0913-015	1/2"	40	20
0913-020	3/4"	30	15
0913-025	1"	16	8
0913-032	1 1/4"	18	9
0913-040	1 1/2"	12	6
0913-050	2"	6	1

- Disponible en latón página 35
Available in brass page 35



FICHA TÉCNICA
TECHNICAL SHEET

1

VÁLVULAS Y FILTROS

VALVES AND FILTERS



1

VÁLVULAS Y FILTROS

VALVES AND FILTERS

1.3

FUNDICIÓN

CASTING

Rango de temperatura °C
Temperature range °C

 -20°
120°



Aplicaciones

Calefacción, ventilación y aire acondicionado. Tratamiento y sistemas de distribución de agua. Industria de la minería. Construcciones navales. Plantas químicas y petroquímicas. Industria azucarera. Procesos químicos y alimetación. Gas y aceite. Sistemas contraincendios. Sistemas sanitarios.

Applications

Heating, air conditioning and ventilating. Water treatment and distribution systems. Mining industry. Shipbuilding and off-shore industries. Chemical and petrochemical plants. Sugar industry. Food and chemistry processing. Oil and gas. Fire fighting systems. Sanitary systems.

VÁLVULAS Y FILTROS DE FUNDICIÓN

CASTING VALVES AND FILTERS

Válvulas de mariposa Butterfly valves	50
Válvulas de retención Non return valves	57
Válvulas de compuerta Gate valves	58
Válvulas esfera Ball valves	59
Válvulas de globo Globe valves	60
Filtros Filters	61
Manguitos elásticos Expansion joins	62

Producto 5114

Válvula de mariposa tipo Wafer disco inoxidable asiento blando EPDM (p.50)

Product 5114

Butterfly valve wafer type stainless steel disc EPDM soft seat (p.50)



VÁLVULAS DE MARIPOSA BUTTERFLY VALVES

CÓDIGO CODE
MEDIDA SIZE

5114



Válvula de mariposa tipo wafer disco inoxidable asiento blando EPDM

- Fabricado en fundición Nodular GGG-40 (GJS-400)
- Recubrimiento en pintura Epoxy RAL5013
- Disco acero inoxidable AISI-316
- Diseño s/ EN-12334, DIN 3202, EN 558-1
- Bridas s/ UNE EN-1092-2 PN6-10-PN16 Ansi B16.5 Clase 125/150
- Presión máxima de trabajo: 2"-10": 16 Bar (250PSI) 12": 10 Bar
- Temperatura de trabajo: -20°C/120°C

Butterfly valve wafer type stainless steel disc EPDM soft seat

- Made of ductile Iron GGG-40 (GJS-400)
- Epoxy coating Epoxy RAL5013
- Stainless steel disc AISI-316
- Design according to EN-12334, DIN 3202, EN 558-1
- Flanges according to UNE EN-1092-2 PN6-10-PN16 Ansi B16.5 Class 125/150
- Working pressure (Max): 2"-10": 16 Bar (250PSI) 12": 10 Bar
- Working temperature: -20°C / 120°C

5114-040	1 1/2"
5114-050	2"
5114-065	2 1/2"
5114-080	3"
5114-100	4"
5114-125	5"
5114-150	6"
5114-200	8"
5114-250	10"

- Para automatización, consultar capítulo 3
See automation valves on chapter 3



FICHA TÉCNICA
TECHNICAL SHEET

5114MR



Válvula de mariposa tipo wafer asiento blando EPDM reductor manual

- Fabricado en fundición Nodular GGG-40 (GJS-400)
- Recubrimiento en pintura Epoxy RAL5013
- Epoxy coating RAL5013
- Disco acero inoxidable AISI-316
- Asiento elastómero EPDM asiento blando
- Diseño s/ EN-12334, DIN 3202, EN 558-1
- Bridas s/ UNE EN-1092-2 PN6-10-PN16 Ansi B16.5 Clase 125/150
- Presión máxima de trabajo: 2"-12": 16 Bar (250PSI)
- Temperatura de trabajo: -20°C / 120°C

Butterfly valve wafer type EPDM soft seat gear operator

- Made of ductile Iron GGG-40 (GJS-400)
- Epoxy coating RAL5013
- Stainless steel disc AISI-316
- EPDM seat gasket soft seat
- Design according to EN-12334, DIN 3202, EN 558-1
- Flanges according to UNE EN-1092-2 PN6-10-PN16 Ansi B16.5 Class 125/150
- Working pressure (Max): 2"-12": 16 Bar (250PSI) 14"-24": 10 Bar (150PSI)
- Working temperature: -20°C / 120°C

5114-050MR	2"
5114-065MR	2 1/2"
5114-080MR	3"
5114-100MR	4"
5114-125MR	5"
5114-150MR	6"
5114-200MR	8"
5114-250MR	10"
5114-300MR	12"
5114-350MR	14"
5114-400MR	16"
5114-500MR	20"
5114-600MR	24"



FICHA TÉCNICA
TECHNICAL SHEET

CÓDIGO CODE _____
MEDIDA SIZE _____

51142



Válvula de mariposa tipo wafer disco inoxidable asiento blando NBR

- Fabricado en fundición Nodular GGG-40 (GJS-400)
- Recubrimiento en pintura Epoxy RAL5013
- Disco acero inoxidable AISI-316
- Asiento en NBR
- Diseño s/ EN-12334, DIN 3202, EN 558-1
- Bridas s/ UNE EN-1092-2 PN6-10-16 Ansi B16.5 Clase 125/150
- Presión máxima de trabajo: 2"-10": 16 Bar (250PSI)
- Temperatura de trabajo: -20°C/80°C

Butterfly valve wafer type stainless steel disc NBR soft seat

- Made of ductile Iron GGG-40 (GJS-400)
- Epoxy coating Epoxy RAL5013
- Stainless steel disc AISI-316
- NBR seat
- Design according to EN-12334, DIN 3202, EN 558-1
- Flanges according to UNE EN-1092-2 PN6-10-16 Ansi B16.5 Class 125/150
- Working pressure (Max): 2"-10": 16 Bar (250PSI)
- Working temperature: -20°C / 80°C

51142-050	2"
51142-065	2 1/2"
51142-080	3"
51142-100	4"
51142-125	5"
51142-150	6"
51142-200	8"
51142-250	10"

• Para automatización, consultar capítulo 3
See automation valves on chapter 3



FICHA TÉCNICA
TECHNICAL SHEET

51142MR

NEW



Válvula de mariposa tipo wafer disco inoxidable asiento blando NBR

- Fabricado en fundición Nodular GGG-40 (GJS-400)
- Recubrimiento en pintura Epoxy RAL5013
- Disco acero inoxidable AISI-316
- Asiento en NBR
- Diseño s/ EN-12334, DIN 3202, EN 558-1
- Bridas s/ UNE EN-1092-2 PN6-10-16 Ansi B16.5 Clase 125/150
- Presión máxima de trabajo: 2"-10": 16 Bar (250PSI)
- Temperatura de trabajo: -20°C/80°C

Butterfly valve wafer type stainless steel disc NBR soft seat

- Made of ductile Iron GGG-40 (GJS-400)
- Epoxy coating Epoxy RAL5013
- Stainless steel disc AISI-316
- NBR seat
- Design according to EN-12334, DIN 3202, EN 558-1
- Flanges according to UNE EN-1092-2 PN6-10-16 Ansi B16.5 Class 125/150
- Working pressure (Max): 2"-10": 16 Bar (250PSI)
- Working temperature: -20°C / 80°C

51142-050MR	2"
51142-065MR	2 1/2"
51142-080MR	3"
51142-100MR	4"
51142-125MR	5"
51142-150MR	6"
51142-200MR	8"
51142-250MR	10"
51142-300MR	12"



FICHA TÉCNICA
TECHNICAL SHEET

CÓDIGO CODE _____
MEDIDA SIZE _____

5140



Válvula de mariposa tipo wafer EPDM disco poliamida 11

- Fabricado en fundición nodular GGG-40 (GJS-400)
- Recubrimiento en pintura Epoxy RAL3020 (250µ)
- Disco fundición con recubrimiento en poliamida 11 (200µ)
- Asiento EPDM
- Bridas según UNE EN1092-2 PN6-10-16
- ANSI B16.5 Clase 125/150
- Working pressure (max): 16 Bar (PN-16)
- Working temperatura: -20°C / 120°C

Butterfly valve wafer type EPDM polyamide 11 disc

- Made of ductile iron GGG-40 (GJS-400)
- Epoxy coating RAL3020 (250µ)
- Disc on ductile iron with polyamide 11 coating (200µ)
- EPDM seat gasket
- Flanges according to UNE EN1092-2 PN6-10-16
- Working pressure (max): 16 Bar (PN-16)
- Working temperatura: -20°C / 120°C

5140-050	2"
5140-065	2 1/2"
5140-080	3"
5140-100	4"
5140-125	5"
5140-150	6"
5140-200	8"
5140-250	10"

• Para automatización, consultar capítulo 3
See automation valves on chapter 3



FICHA TÉCNICA
TECHNICAL SHEET

5141



Válvula de mariposa tipo wafer disco inoxidable asiento blando EPDM

- Fabricado en fundición nodular GGG-40 (GJS-400)
- Recubrimiento en pintura Epoxy RAL3020 (250µ)
- Disco acero inoxidable AISI-316
- Asiento EPDM
- Bridas según UNE EN1092-2 PN6-10-16 ANSI B16.5 Clase 125/150
- Presión máxima de trabajo: 16 Bar (PN-16)
- Temperatura de trabajo: -20°C / 120°C

Butterfly valve wafer type stainless steel disc EPDM soft seat

- Made of ductile iron GGG-40 (GJS-400)
- Epoxy coating RAL3020 (250µ)
- Stainless steel disc AISI-316
- Asiento EPDM
- Flanges according to UNE EN1092-2 PN6-10-16 ANSI B16.5 Class 125/150
- Working pressure (max): 16 Bar (PN-16)
- Working temperature: -20°C / 120°C

5141-040	1 1/2"
5141-050	2"
5141-065	2 1/2"
5141-080	3"
5141-100	4"
5141-125	5"
5141-150	6"
5141-200	8"
5141-250	10"

• Disponible hasta agotar existencias
While stocks lasts



FICHA TÉCNICA
TECHNICAL SHEET

51143



Válvula de mariposa tipo wafer disco y asiento PTFE

- Fabricado en fundición dúctil GGG-40 (GJS-400)
- Recubrimiento en pintura RAL5013 Epoxy
- Disco acero inoxidable 316 + PTFE
- Asiento PTFE
- Bridas s/ UNE EN1092-2 PN10-PN16 ANSI B16.5 Clase 125/150
- Presión máxima de trabajo: 16 Bar DN200 PN10
- Temperatura de trabajo: -20°C / 180°C

Butterfly valve wafer type PTFE disc and seat

- Made of ductile iron GGG-40 (GJS-400)
- Epoxy coating RAL5013
- Stainless steel disc 316 + PTFE
- PTFE seat gasket
- Flanges according to UNE EN1092-2 PN10 ANSI B16.1 Class 125/150 PN16
- Working pressure (Max): 16 Bar DN200 PN10
- Working temperature: -20°C / 180°C

51143-050	2"
51143-065	2 1/2"
51143-080	3"
51143-100	4"
51143-125	5"
51143-150MR*	6"
51143-200MR*	8"

* Reductor manual
* Gear operator

• Para automatización, consultar capítulo 3
See automation valves on chapter 3



FICHA TÉCNICA
TECHNICAL SHEET

CÓDIGO CODE _____
MEDIDA SIZE _____

51151



Válvula de mariposa tipo wafer disco inoxidable asiento rígido EPDM

ECO

- Fabricado en fundición gris DN50-DN150 GG25 y fundición dúctil >DN200 GGG-40
- Recubrimiento en pintura Epoxy RAL5013
- Disco acero inoxidable AISI-316
- Material asiento: EPDM
- Diseño s/ EN-12334, DIN 3202, EN 558-1
- Bridas PN-10/PN-16 Ansi B16.5 Clase 125/150
- Presión máxima de trabajo: 16 Bar (250 psi)
- Temperatura de trabajo: -20°C/120°C

Butterfly valve wafer type stainless steel disc EPDM hard seat

- Made of cast iron DN25-DN150 GG25 and ductil iron >DN200 GGG-40
- Epoxy coating epoxy RAL5013
- Stainless steel disc AISI-316
- Seat gasket material: EPDM
- Design according to EN-12334, DIN 3202, EN 558-1
- Flanges according to UNE EN-1092-2 PN-10/ PN-16 Ansi B16.5 Class 125/150
- Working pressure (max): 16 Bar (250 psi)
- Working temperature: -20°C/120°C

51151-040	1 1/2"
51151-050	2"
51151-065	2 1/2"
51151-080	3"
51151-100	4"
51151-125	5"
51151-150	6"
51151-200	8"
51151-250	10"

• Para automatización, consultar capítulo 3
See automation valves on chapter 3



FICHA TÉCNICA
TECHNICAL SHEET

51151MR



Válvula de mariposa tipo wafer disco inoxidable asiento rígido EPDM con reductor manual

ECO

- Fabricado en fundición DN50-DN150 GG-25 Fundición dúctil >DN200 GGG-40
- Recubrimiento en pintura Epoxy RAL5013
- Disco acero inoxidable AISI-316
- Asiento elastómero EPDM
- Diseño s/ EN-12334, DIN 3202, EN 558-1
- Bridas según UNE EN1092-2 PN-10/PN-16
- Presión máxima de trabajo: 2"-12": 16 Bar 14"-16": 10 Bar
- Temperatura de trabajo: -20°C / 120°C

Butterfly valve wafer type stainless steel disc EPDM hard seat with gear operator

- Made of cast iron DN50-DN150 GG-25 ductile iron >DN200 GGG-40
- Epoxy coating RAL5013
- Stainless steel disc AISI-316
- EPDM seat gasket
- Design according to EN-12334, DIN 3202, EN 558-1
- Flanges according to UNE EN1092-2 PN-10/ PN-16
- Working pressure (max): 2"-12": 16 Bar 14"-16": 10 Bar
- Working temperature: -20°C / 120°C

51151-050MR	2"
51151-065MR	2 1/2"
51151-080MR	3"
51151-100MR	4"
51151-125MR	5"
51151-150MR	6"
51151-200MR	8"
51151-250MR	10"
51151-300MR	12"
51151-350MR	14"
51151-400MR	16"



FICHA TÉCNICA
TECHNICAL SHEET

CÓDIGO CODE _____
MEDIDA SIZE _____

5115



Válvula de mariposa tipo wafer disco cromado asiento rígido EPDM

ECO

- Fabricado en fundición gris DN50-DN150 GG25 y fundición dúctil >DN200 GGG-40
- Recubrimiento en pintura epoxy RAL5013
- Disco cromado fundición dúctil EN-GJS-400
- Material asiento: EPDM
- Diseño s/ EN-12334, DIN 3202, EN 558-1
- Bridas s/ UNE EN-1092-2 PN10-PN16 Ansi B16.5 Clase 125/150
- Presión máxima de trabajo:
- 2"-12": 16 Bar (250PSI)
- Temperatura de trabajo: -20°C / 120°C

Butterfly valve wafer type chromed disc EPDM hard seat

- Made of cast iron DN25-DN150 GG25 and ductil iron >DN200 GGG-40
- Epoxy coating Epoxy RAL5013
- Chromed ductile iron EN-GJS-400
- Seat gasket material: EPDM
- Design according to EN-12334, DIN 3202, EN 558-1
- Flanges according to UNE EN-1092-2 PN10-PN16 Ansi B16.5 Class 125/150
- Working pressure (Max):
- 2"-12": 16 Bar (250PSI)
- Working temperature: -20°C / 120°C

5115-040	1 1/2"
5115-050	2"
5115-065	2 1/2"
5115-080	3"
5115-100	4"
5115-125	5"
5115-150	6"
5115-200	8"
5115-250	10"
5115-300*	12"

* Disponible hasta agotar existencias
* While stocks lasts

• Para automatización, consultar capítulo 3
See automation valves on chapter 3



FICHA TÉCNICA
TECHNICAL SHEET

5115MR



Válvula de mariposa tipo wafer disco cromado asiento rígido EPDM con reductor manual

ECO

- Fabricado en fundición gris DN50-DN150 GG-25 y fundición dúctil >DN200 GGG-40
- Recubrimiento en pintura epoxy RAL5013
- Disco cromado fundición dúctil EN-GJS-400
- Material asiento: EPDM
- Diseño s/ EN-12334, DIN 3202, EN 558-1
- Bridas s/ UNE EN-1092-2 PN10-PN16 Ansi B16.5 Clase 125/150
- Presión máxima de trabajo: 2"-12": 16 Bar (250PSI) 14"-24": 10 Bar (150PSI)
- Temperatura de trabajo: -20°C / 120°C

Butterfly valve wafer type chromed disc EPDM hard seat with gear operator

- Made of cast iron DN25-DN150 GG-25 and ductil iron >DN200 GGG-40
- Epoxy coating epoxy RAL5013
- Chromed ductile iron EN-GJS-400
- Seat gasket material: EPDM
- Design according to EN-12334, DIN 3202, EN 558-1
- Flanges according to UNE EN-1092-2 PN10-PN16 Ansi B16.5 Class 125/150
- Working pressure (Max): 2"-12": 16 Bar (250PSI) 14"-24": 10 Bar (150PSI)
- Working temperature: -20°C / 120°C

5115-050MR	2"
5115-065MR	2 1/2"
5115-080MR	3"
5115-100MR	4"
5115-125MR	5"
5115-150MR	6"
5115-200MR	8"
5115-250MR	10"
5115-300MR	12"
5115-350MR	14"
5115-400MR	16"
5115-500MR	20"
5115-600MR	24"



FICHA TÉCNICA
TECHNICAL SHEET

CÓDIGO CODE _____
MEDIDA SIZE _____

5144



Válvula de mariposa tipo lug disco inoxidable asiento blando NBR

- Fabricado en fundición dúctil GGG-40
- Recubrimiento en pintura Epoxy RAL5013
- Disco acero inoxidable AISI-316
- Asiento en elastómero NBR
- Fabricado bajo normativa: EN-1092-2 PN16
- Presión máxima de trabajo: 16 Bar
- Temperatura de trabajo: -20°C / 80°C

Butterfly valve lug type stainless steel disc NBR soft seat

- Made of ductile iron GGG-40
- Epoxy coating RAL5013
- Stainless steel disc AISI-316
- NBR seat gasket
- Manufactured according to standards: EN-1092-2 PN16
- Working pressure (Max): 16 Bar
- Working temperature: -20°C / 80°C

5144-050	2"
5144-065	2 1/2"
5144-080	3"
5144-100	4"
5144-125	5"
5144-150	6"
5144-200	8"

• Para automatización, consultar capítulo 3
See automation valves on chapter 3



FICHA TÉCNICA
TECHNICAL SHEET

5144MR



Válvula de mariposa tipo lug disco inoxidable asiento blando NBR con reductor manual

- Fabricado en fundición dúctil GGG-40
- Recubrimiento en pintura Epoxy RAL5013
- Disco acero inoxidable AISI-316
- Asiento en elastómero NBR
- Fabricado bajo normativa: EN-1092-2 PN16
- Presión máxima de trabajo: 16 Bar
- Temperatura de trabajo: -20°C / 80°C

Butterfly valve lug type stainless steel disc NBR soft seat, gear box

- Made of ductile iron GGG-40
- Epoxy coating RAL5013
- Stainless steel disc AISI-316
- NBR seat gasket
- Manufactured according to standards: EN-1092-2 PN16
- Working pressure (Max): 16 Bar
- Working temperature: -20°C / 80°C

5144-050MR	2"
5144-065MR	2 1/2"
5144-080MR	3"
5144-100MR	4"
5144-125MR	5"
5144-150MR	6"
5144-200MR	8"
5144-250MR	10"
5144-300MR	12"



FICHA TÉCNICA
TECHNICAL SHEET

CÓDIGO CODE _____
MEDIDA SIZE _____

51442

NEW



Válvula de mariposa tipo lug disco inoxidable asiento blando EPDM

- Fabricado en fundición dúctil GGG-40
- Recubrimiento en pintura Epoxy RAL5013
- Disco acero inoxidable AISI-316
- Asiento en elastómero EPDM
- Fabricado bajo normativa: EN-1092-2 PN16
- Presión máxima de trabajo: 16 Bar
- Temperatura de trabajo: -20°C / 80°C

Butterfly valve lug type stainless steel disc EPDM soft seat

- Made of ductile iron GGG-40
- Epoxy coating RAL5013
- Stainless steel disc AISI-316
- EPDM seat gasket
- Manufactured according to standards: EN-1092-2 PN16
- Working pressure (Max): 16 Bar
- Working temperature: -20°C / 80°C

51442-050	2"
51442-065	2 1/2"
51442-080	3"
51442-100	4"
51442-125	5"
51442-150	6"
51442-200	8"



**FICHA TÉCNICA
TECHNICAL SHEET**

51442MR

NEW



Válvula de mariposa tipo lug disco inoxidable asiento blando EPDM con reductor manual

- Fabricado en fundición dúctil GGG-40
- Recubrimiento en pintura Epoxy RAL5013
- Disco acero inoxidable AISI-316
- Asiento en elastómero EPDM
- Fabricado bajo normativa: EN-1092-2 PN16
- Presión máxima de trabajo: 16 Bar
- Temperatura de trabajo: -20°C / 80°C

Butterfly valve lug type stainless steel disc EPDM soft seat with gear box

- Made of ductile iron GGG-40
- Epoxy coating RAL5013
- Stainless steel disc AISI-316
- EPDM seat gasket
- Manufactured according to standards: EN-1092-2 PN16
- Working pressure (Max): 16 Bar
- Working temperature: -20°C / 80°C

51442-050MR	2"
51442-065MR	2 1/2"
51442-080MR	3"
51442-100MR	4"
51442-125MR	5"
51442-150MR	6"
51442-200MR	8"
51442-250MR	10"
51442-300MR	12"



**FICHA TÉCNICA
TECHNICAL SHEET**

- **Recambio** Reductor manual para válvulas de mariposa disponible en página 221
Spare part Hand wheel gear box for butterfly valves available page 221



VÁLVULAS DE RETENCIÓN NON RETURN VALVES

CÓDIGO CODE
MEDIDA SIZE

5116



Válvula de retención doble disco Inoxidable

Stainless Steel double disc check valve

- Fabricado en fundición Nodular GGG-40 (GJS-400)
- Recubrimiento en pintura Epoxy RAL5013 (250µ)
- Disco acero inoxidable AISI-304
- Asiento EPDM
- Bridas según UNE EN-1092-2 PN-10/PN-16 ANSI B16.5 Clase 125/150
- Presión máxima de trabajo: 16 Bar
- Temperatura de trabajo: -10°C / 80°C

- Made of ductile iron GGG-40 (GJS-400)
- Epoxy coating RAL5013 (250µ)
- Stainless steel disc AISI-304
- EPDM seat gasket
- Flanges according to UNE EN-1092-2 PN-10/PN-16
- ANSI B16.5 Class 125/150
- Working pressure (max): 16 Bar
- Working temperature: -10°C / 80°C

5116-040	1 1/2"
5116-050	2"
5116-065	2 1/2"
5116-080	3"
5116-100	4"
5116-125	5"
5116-150	6"
5116-200	8"
5116-250	10"
5116-300	12"
5116-350	14"



FICHA TÉCNICA
TECHNICAL SHEET

5125



Válvula de retención bola NBR con bridas

Ball check valve, NBR ball, flanged end

- Fabricado en fundición nodular GGG-40 (GJS-400)
- Recubrimiento en pintura Epoxy RAL5013 (250µ)
- Bola metálica con recubrimiento elastómero NBR
- Tornillería inoxidable AISI-304
- Diseño s/ EN-12334, DIN 3202, EN 558-1
- Bridas s/ UNE EN1092-2
- Presión máxima de trabajo: 16 Bar
- Temperatura de trabajo: 0°C / 80°C
- Presión mínima de apertura 0'05 Bar

- Made of nodular ductile Iron GGG-40 (GJS-400)
- Epoxy coating RAL5013 (250µ)
- Metal ball coated by NBR rubber
- Stainless steel bolts AISI-304
- Design according to EN-12334, DIN 3202, EN 558-1
- Flanges according to UNE EN1092-2
- Working pressure (Max): 16 Bar
- Working temperature (Max): 0° / 80°C
- Minimum opening pressure 0'05 Bar

5125-040	1 1/2"
5125-050	2"
5125-065	2 1/2"
5125-080	3"
5125-100	4"
5125-125	5"
5125-150	6"
5125-200	8"
5125-250	10"
5125-300	12"
5125-350	14"



FICHA TÉCNICA
TECHNICAL SHEET

5142



Válvula de retención bola NBR roscada

Check valve threaded end NBR ball

- Fabricado en fundición nodular EN-GJS-400
- Recubrimiento en pintura Epoxy RAL5013 (250µ)
- Bola de elastómero NBR
- Fabricado bajo normativa: UNE-EN-12334
- Roscas de conexión s/ norma ISO228
- Presión Máxima de trabajo: 10 Bar
- Temperatura de trabajo: 0°C / 80°C
- Presión mínima de apertura 0'01 Bar

- Made of ductile iron EN-GJS-400
- Epoxy coating RAL5013 (250µ)
- NBR rubber ball
- Manufactured according to standard UNE-EN-12334
- Connection threads according to standard ISO228
- Working pressure (Max): 10 Bar
- Working temperature: 0°C / 80°C
- Minimum opening pressure 0'01 Bar

5142-020	3/4"
5142-025	1"
5142-032	1 1/4"
5142-040	1 1/2"
5142-050	2"
5142-065	2 1/2"
5142-080	3"



FICHA TÉCNICA
TECHNICAL SHEET



VÁLVULAS DE COMPUERTA GATE VALVES

CÓDIGO CODE _____
MEDIDA SIZE _____

5113



Válvula de compuerta con bridas, eje fijo, cierre elástico EPDM

- Fabricado en fundición GGG-50 (GJS-500)
- Recubrimiento en pintura Epoxy RAL5013 (250µ)
- Asiento elástico fundición + recubrimiento EPDM
- Accionamiento mediante volante o cuadrado
- Bridas S/UNE EN-1092-2 PN16
- Presión máxima de trabajo: 16 Bar (PN16)
- Temperatura de trabajo: -10°C / 120°C

EPDM resilient wedge gate valve, flanged ends

- Made of ductile iron GGG-50 (GJS-500)
- Epoxy coating RAL5013 (250µ)
- Ductile iron wedge coated by EPDM rubber
- Actuated by handwheel or square nut
- Flanges according to UNE EN-1092-2 PN16
- Working pressure (Max): 16 Bar (PN16)
- Working temperature: -10°C / 120°C

5113-040	1 1/2"
5113-050	2"
5113-065	2 1/2"
5113-080	3"
5113-100	4"
5113-125	5"
5113-150	6"
5113-200	8"
5113-250	10"
5113-300	12"
5113-350	14"
5113-400	16"
5113-500	20"
5113-600	24"

- Bridas PN-10 / PN-16 de 5113-040 hasta 5113-150.
Bridas PN-16 de 5113-200 hasta 5113-600
Flanges PN-10 / PN-16 from 5113-040 to 5113-150.
Flanges PN-16 from 5113-200 to 5113-600



FICHA TÉCNICA
TECHNICAL SHEET

5143



Válvula de compuerta cierre elástico EPDM extremos roscados

WRAS

- Fabricado en fundición GGG-50 (GJS-500)
- Recubrimiento en pintura Epoxy RAL5013 (250µ)
- Diseño según EN-12334
- Asiento elástico fundición con recubrimiento elastómero EPDM
- Accionamiento mediante volante o cuadrado (30mm)
- Presión máxima de trabajo: 16 Bar (PN-16)
- Temperatura de trabajo: -10°C / 120°C

EPDM Resilient wedge gate valve, threaded ends

- Made of ductile iron GGG-50 (GJS-500)
- Epoxy coating RAL5013 (250µ)
- Design according to EN-12334
- Ductile iron wedge coated by EPDM rubber
- Actuated by handwheel or square nut (30mm)
- Working pressure (max): 16 Bar (PN-16)
- Working temperature: -10°C / 120°C

5143-020	3/4"
5143-025	1"
5143-032	1 1/4"
5143-040	1 1/2"
5143-050	2"



FICHA TÉCNICA
TECHNICAL SHEET

- **Recambios** disponibles en página 225
Spare parts available page 225



VÁLVULAS ESFERA BALL VALVES

CÓDIGO CODE _____
MEDIDA SIZE _____

5137



Válvula esfera dos piezas de hierro fundido con bridas

- Cuerpo fabricado en fundición gris (EN-GJL-250)
- Bola fabricada en acero inoxidable (AISI-201)
- Asientos de bola de PTFE
- Juntas en PTFE
- Bridas s/ UNE EN1092-2 PN16
- Cara a cara s/ UNE EN 558-1
- Presión máxima de trabajo: 16 Bar
- Temperatura de trabajo: -20°C / 120°C

Ball valve two pieces cast iron with flanges

- Body made of cast iron (EN-GJL-250)
- Stainless steel (AISI-201) ball
- Ball seats made of PTFE
- PTFE seat gaskets
- Flanges according to UNE EN1092-2 PN16
- Face to face according to UNE EN 558-1
- Working pressure (Max): 16 Bar
- Working temperature: -20°C / 120°C

5137-015	1/2"
5137-025	1"
5137-032	1 1/4"
5137-065	2 1/2"
5137-100	4"
5137-125	5"
5137-150	6"

- Disponible hasta agotar existencias
While stocks lasts



FICHA TÉCNICA
TECHNICAL SHEET

5145



Válvula esfera paso reducido una pieza

- Cuerpo fabricado en fundición gris (EN-GJL-250)
- Bola fabricada en acero inoxidable AISI-304
- Asientos de bola de PTFE reforzado
- Eje en acero inoxidable AISI-420
- Terminación a soldar según UNE-EN-12627
- Presión máxima de trabajo: DN25-50: 40 Bar
DN65-300MR*: 25 Bar
- Temperatura de trabajo: -30°C / 200°C

One piece reduced bore ball valve

- Body made of cast iron (EN-GJL-250)
- AISI-304 stainless steel ball
- Ball seats made of reinforced PTFE
- AISI-420 stainless steel stem
- Welding ends according to UNE-EN-12627
- Working pressure: DN25-50: 40 Bar
DN65-300MR*: 25 Bar
- Working temperature: -30°C / 200°C

5145-015	1/2"
5145-020	3/4"
5145-025	1"
5145-032	1 1/4"
5145-040	1 1/2"
5145-050	2"
5145-065	2 1/2"
5145-080	3"
5145-100	4"
5145-125	5"
5145-150	6"
5145-200	8"
5145-250MR*	10"
5145-300MR*	12"

- * Reductor manual
* Gear operator



FICHA TÉCNICA
TECHNICAL SHEET



VÁLVULAS DE GLOBO GLOBE VALVES

CÓDIGO CODE _____
MEDIDA SIZE _____

5130



Válvula de globo en acero al carbono con fuelle embreadada PN-40

- Fabricado en acero al carbono GS-C25
- Asiento en acero inoxidable 2Cr13 Stelite
- Fuelle INOX AISI-304 y juntas de grafito
- Fabricado bajo normativa: DIN 3356-82, EN-1092-2 PN40, DIN3202 F1
- Presión Máxima de trabajo: 40 Bar (PN40)
- Temperatura de trabajo: -10°C / 400°C

Cast steel bellow globe valve flanged ends PN-40

- Made of carbon steel casting GS-C25
- Stainless steel seat 2Cr13 Stelite
- Bellow in S.S. AISI-304 and graphite gaskets
- Manufactured according to standards: DIN 3356-82, En-1092-2 PN40, DIN3202 F1
- Working pressure (Max): 40 Bar (PN40)
- Working temperature: -10°C / 400°C

5130-015	1/2"
5130-020	3/4"
5130-025	1"
5130-032	1 1/4"
5130-040	1 1/2"
5130-050	2"
5130-065	2 1/2"
5130-080	3"
5130-100	4"
5130-125	5"
5130-150	6"
5130-200	8"



FICHA TÉCNICA
TECHNICAL SHEET

51302



Válvula de globo en acero al carbono con fuelle embreadada PN-16

- Fabricado en acero al carbono GS-C25
- Asiento en acero inoxidable 2Cr13 Stelite
- Fuelle INOX AISI-304 y juntas de grafito
- Fabricado bajo normativa: DIN 3356-82, EN-1092-2 PN16, DIN3202 F1
- Presión Máxima de trabajo: 16 Bar (PN16)
- Temperatura de trabajo: -10°C / 400°C

Cast steel bellow globe valve flanged ends PN-16

- Made of carbon steel casting GS-C25
- Stainless steel seat 2Cr13 Stelite
- Bellow in S.S. AISI-304 and graphite gaskets
- Manufactured according to standards: DIN 3356-82, En-1092-2 PN16, DIN3202 F1
- Working pressure (Max): 16 Bar (PN16)
- Working temperature: -10°C / 400°C

51302-015	1/2"
51302-020	3/4"
51302-025	1"
51302-032	1 1/4"
51302-040	1 1/2"
51302-050	2"
51302-065	2 1/2"
51302-080	3"
51302-100	4"
51302-125	5"
51302-150	6"
51302-200	8"
51302-250	10"



FICHA TÉCNICA
TECHNICAL SHEET

5131



Válvula de globo en fundición embreadada PN-16

- Fabricado en acero al carbono GG-25
- Recubrimiento en pintura Epoxy RAL5013 (250µ)
- Asiento en acero inoxidable AISI-304
- Juntas de grafito
- Fabricado bajo normativa: DIN 86251, DIN 2501, DIN3202 F1, EN-1092-2 PN16
- Presión máxima de trabajo: 16 Bar (PN16)
- Temperatura de trabajo: -20°C / 200°C

Cast steel bellow globe valve flanged ends PN-16

- Made of ductile iron GG-25
- Epoxy coating Epoxy RAL5013 (250µ)
- Stainless steel seat AISI-304
- Graphite gaskets
- Manufactured according to standards: DIN 86251, DIN 2501, DIN3202 F1, EN-1092-2 PN16
- Working pressure (Max): 16 Bar (PN16)
- Working temperature: -20°C / 200°C

5131-015	1/2"
5131-020	3/4"
5131-025	1"
5131-032	1 1/4"
5131-040	1 1/2"
5131-050	2"
5131-065	2 1/2"
5131-080	3"
5131-100	4"
5131-125	5"
5131-150	6"
5131-200	8"



FICHA TÉCNICA
TECHNICAL SHEET



FILTROS FILTERS

CÓDIGO CODE
MEDIDA SIZE

5110



Filtro en "Y" embreadado con tamiz 1,8mm

- Fabricado en fundición GG-25 (GJL-250)
- Recubrimiento en pintura Epoxy RAL5013 (250µ)
- Junta unión tapa EPDM
- Tamiz fabricado en acero inoxidable AISI 304
- Agujero tamiz 1,8mm (1.800 micras)
- Diseño s/ DIN 3202, EN 558-1
- Bridas s/ UNE EN1092-2
- Presión máxima de trabajo: 16 Bar (PN16)
- Temperatura de trabajo: -10°C / 100°C
- No apto para concentraciones de glicol >10%

Flanged 'Y' Strainer with sieve 1,8mm

- Made of ductile iron GG-25 (GJL-250)
- Epoxy coating RAL5013 (250µ)
- Cup joint EPDM
- Internal sieve made of stainless steel AISI 304
- Hole sieve size 1,8mm (1.800 microns)
- Design according to DIN 3202, EN 558-1
- Flanges according to UNE EN1092-2
- Working pressure (Max): 16 Bar (PN16)
- Working temperature: -10°C / 100°C
- Not suitable for glycol concentrations greater than 10%

5110-040	1 1/2"
5110-050	2"
5110-065	2 1/2"
5110-080	3"
5110-100	4"
5110-125	5"
5110-150	6"
5110-200	8"
5110-250	10"
5110-300	12"
5110-350	14"
5110-400	16"



FICHA TÉCNICA
TECHNICAL SHEET

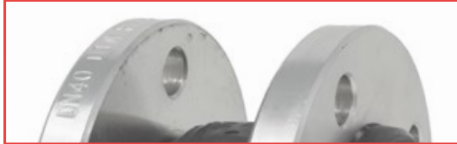

MANGUITOS ELÁSTICOS EXPANSION JOINS

5120 EPDM 51202 NBR



Manguito elástico doble onda extremos roscados

- Tuercas de acero al carbono galvanizado
- Cuerpo de elastómero EPDM (Ref. 5120) o NBR (Ref.51202)
- Tejido interior de poliamida 6
- Roscas BSPT según norma ISO 228/1
- Presión nominal de trabajo: 16 Bar
- Presión de rotura: 30 Bar
- Temperatura de trabajo: -20°C / 120°C (Ref.5120) -20°C / 80°C (Ref.51202)
- Trabajo en vacío: 0.53 Bar

Double sphere rubber expansion joint threaded ends

- Nuts made of galvanized carbon steel
- EPDM (Ref.5120) or NBR (Ref.51202) rubber body
- Polyamide 6 inner fabric
- BSPT threads under ISO228/1
- Working pressure: 16 Bar
- Bursting pressure: 30 Bar
- Working temperature: -20°C / 120°C (Ref.5120) -20°C / 80°C (Ref.51202)
- Vacuum pressure: 0.53 Bar

CÓDIGO CODE
MEDIDA SIZE

5120-020	51202-020	3/4"
5120-025	51202-025	1"
5120-032	51202-032	1 1/4"
5120-040	51202-040	1 1/2"
5120-050	51202-050	2"
5120-065	51202-065	2 1/2"



FICHA TÉCNICA
TECHNICAL SHEET

5121 EPDM 51212 NBR



Manguito elástico simple onda con bridas

- Bridas de acero al carbono galvanizado
- Dimensiones bridas bajo norma: EN-1092 PN-10 PN-16 de DN32 hasta DN150 EN-1092 PN-16 de DN200 hasta DN400
- Cuerpo de elastómero EPDM (Ref. 5121) o NBR (Ref.51212)
- Tejido interior de poliamida 6
- Cable de acero circular
- Presión nominal de trabajo: 16 Bar
- 5121-0200 PN- 10
- Presión de rotura: 45 Bar
- Temperatura de trabajo: -20°C / 120°C (Ref.5121) -20°C / 80°C (Ref.51212)
- Trabajo en vacío: 0.56 Bar

Single sphere rubber expansion joint flanged ends

- Flanges made of galvanized carbon steel
- Flange drills according to: EN-1092 PN-10 PN-16 from DN32 to DN150 EN-1092 PN-16 from DN200 to DN400
- EPDM (Ref.5121) or NBR (Ref.51212) rubber body
- Polyamide 6 inner fabric
- Circular hard steel wire
- Working pressure: 16 Bar
- 5121-0200 PN- 10
- Bursting pressure: 45 Bar
- Working temperature: -20°C / 120°C (Ref.5121) -20°C / 80°C (Ref.51212)
- Vacuum pressure: 0.56 Bar

5121-032*	51212-032*	1 1/4"
5121-040*	51212-040*	1 1/2"
5121-050*	51212-050*	2"
5121-065*	51212-065*	2 1/2"
5121-080*	51212-080*	3"
5121-100*	51212-100*	4"
5121-125*	51212-125*	5"
5121-150*	51212-150*	6"
5121-200***	51212-200***	8"
5121-0200**	51212-0200**	8"
5121-250***	51212-250***	10"
5121-300***	51212-300***	12"
5121-350***	51212-350***	14"
5121-400***	51212-400***	16"

- PN10/16 *
- PN10**
- PN16 ***



FICHA TÉCNICA
TECHNICAL SHEET

CÓDIGO CODE _____
MEDIDA SIZE _____

5129



Manguito elástico doble onda con bridas

- Bridas de acero al carbono galvanizado
- Dimensiones bridas bajo norma: EN-1092 PN-10 PN-16 de DN32 hasta DN150 EN-1092 PN-10 de DN200 hasta DN250
- Cuerpo de elastómero EPDM
- Tejido interior de poliamida
- Cable de acero circular
- Presión nominal de trabajo: 10 Bar
- Temperatura de trabajo: -20°C / 120°C
- Trabajo en vacío: 0.50 Bar

Double sphere expansion joint flanged ends

- Flanges made of galvanized carbon steel
- Flange drills according to: EN-1092 PN-10 PN-16 from DN32 to DN150 EN-1092 PN-10 from DN200 to DN250
- EPDM rubber body
- Polyamide inner fabric
- Circular hard steel wire
- Working pressure: 10 Bar
- Working temperature: -20°C / 120°C
- Vacuum pressure: 0.50 Bar

5129-050	2"
5129-065	2 1/2"
5129-080	3"
5129-100	4"
5129-125	5"
5129-150	6"
5129-200	8"
5129-250	10"



FICHA TÉCNICA
TECHNICAL SHEET

- **Recambio** Pasador para manguitos elásticos simple onda disponibles en página 225
Spare part Control rod set elastic joints single sphere available page 225

1

VÁLVULAS Y FILTROS

VALVES AND FILTERS



1

VÁLVULAS Y FILTROS

VALVES AND FILTERS

1.4

PVC

PVC

Presión máxima de trabajo en Bar
Maximum working pressure Bar



10

Rango de temperatura °C
Temperature range °C



-10°
60°

Aplicaciones

Instalaciones de agua fría,
químicos, piscinas.

Applications

Facilities cold water, chemicals,
swimmingpool.



Producto 1010 y 2510
Válvula esfera en PVC para
encolar (p.66)

Product 1010 & 2510
PVC ball valve socket ends
(p.66)



VÁLVULAS ESFERA BALL VALVES



FICHA TÉCNICA
TECHNICAL SHEET



CÓDIGO CODE _____
MEDIDA SIZE _____
ENCAJADO GRANDE MASTER CARTON _____
ENCAJADO INTERMEDIO INNER CARTON _____

1010



Válvula esfera en PVC para
encolar PVC ball valve socket
ends

1010-25	25 mm	40	1
1010-32	32 mm	40	1
1010-40	40 mm	16	1
1010-50	50 mm	16	1
1010-63	63 mm	10	1
1010-75	75 mm	3	1
1010-90	90 mm	3	1

- Presión máxima de trabajo: 10 Bar
Working pressure (Max): 10 Bar

101010



Válvula esfera en PVC para
roscar PVC ball valve threaded
ends

101010-25	3/4"	40	1
101010-32	1"	40	1
101010-40	1 1/4"	16	1
101010-50	1 1/2"	16	1
101010-63	2"	10	1
101010-75	2 1/2"	3	1

- Presión máxima de trabajo: 10 Bar
Working pressure (Max): 10 Bar

2510 PASO T



Válvula esfera tres vías en
PVC paso T para encolar T PVC three way ball
valve port socket ends

2510-016	16 mm	40	1
2510-020	20 mm	40	1
2510-025	25 mm	28	1
2510-032	32 mm	36	1
2510-040	40 mm	22	1
2510-050	50 mm	12	1
2510-063	63 mm	10	1

- Presión máxima de trabajo: 10 Bar
Working pressure (Max): 10 Bar

2510 PASO L



Válvula esfera tres vías en
PVC paso L para encolar L PVC three way ball
valve port socket ends

2510-017	16 mm	40	1
2510-021	20 mm	40	1
2510-026	25 mm	28	1
2510-033	32 mm	36	1
2510-041	40 mm	22	1
2510-051	50 mm	12	1
2510-064	63 mm	10	1

- Presión máxima de trabajo: 10 Bar
Working pressure (Max): 10 Bar

2

ACCESORIOS Y BRIDAS

FITTINGS AND FLANGES

2.1 LATÓN 69
1.1 BRASS

2.2 ACERO INOXIDABLE 121
1.2 STAINLESS STEEL

**2.3 HIERRO MALEABLE
GALVANIZADO** 161
1.3 MALLEABLE GALVANIZED IRON



2

ACCESORIOS Y BRIDAS

FITTINGS AND FLANGES

2.1

LATÓN

BRASS

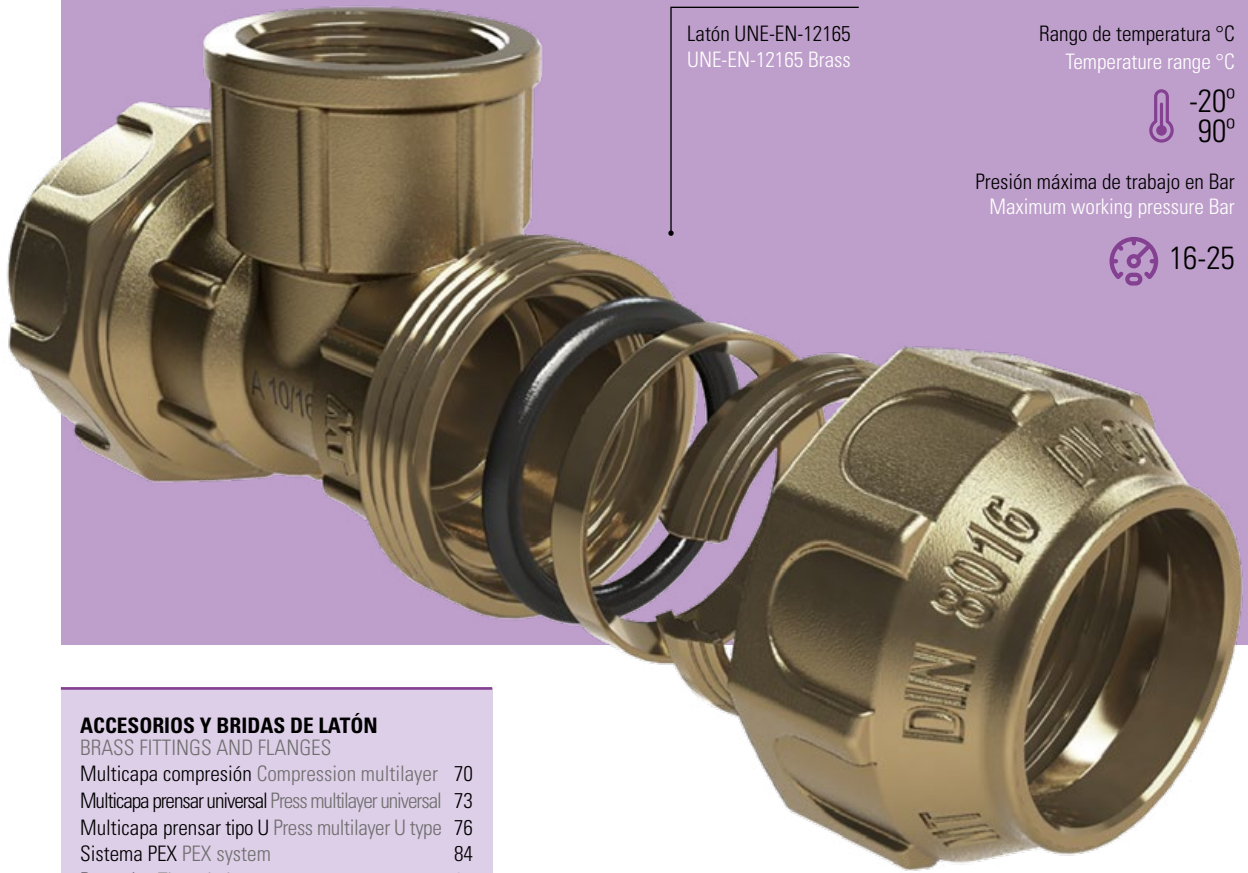

Latón UNE-EN-12165
UNE-EN-12165 Brass

Rango de temperatura °C
Temperature range °C

-20°
90°

Presión máxima de trabajo en Bar
Maximum working pressure Bar

16-25

ACCESORIOS Y BRIDAS DE LATÓN

BRASS FITTINGS AND FLANGES

Multicapa compresión	Compression multilayer	70
Multicapa prensar universal	Press multilayer universal	73
Multicapa prensar tipo U	Press multilayer U type	76
Sistema PEX	PEX system	84
Roscados	Threaded	85
Roscados cromados	Chromed plated threaded	95
Tubería Cu	Cu pipe	98
PE - Tuerca hembra	PE - Female nut	101
PE - Tuerca macho	PE - Male nut	103
PE - Brida	PE - Flange	106
PE - A presión	PE - To pressure	108
PE-Fe - Para tubo de hierro	PE-Fe - For iron pipe	110
Bicón a compresión niquelado	Nickel plated compression bicone	111
Bicón a compresión	Compression bicone	114
MT Garden	MT Garden	118

Producto 88190
Racor te hembra PE-H
(p.102)

Product 88190
PE-F female tee (p.102)



MULTICAPA COMPRESIÓN - SERIE 641 COMPRESSION MULTILAYER - 641 SERIES



ACCESORIO DE COMPRESIÓN PARA TUBERÍA MULTICAPA Y PEX COMPRESSION FITTING FOR MULTILAYER AND PEX PIPES

- Cuerpo en latón CW617N, fabricado s/ UNE EN 12165.
- Compatible con tubería Multicapa y tubería PEX de diámetros: Ø16x2, Ø18x2, Ø20x2, Ø25x2.5, Ø26x3 y Ø32x3.
- Temperatura de trabajo: 95°C a 10 bar.

- Body in brass CW617N, manufactured according to UNE EN 12165.
- Compatible for Multilayer and PEX pipes of diameters: Ø16x2, Ø20x2, Ø25x2.5, Ø26x3 and Ø32x3.
- Working temperature: 95°C at 10 bar.



FICHA TÉCNICA
TECHNICAL SHEET

SERIE 641
641 SERIES

CÓDIGO CODE _____
MEDIDA SIZE _____
ESPEJOR THICKNESS _____
ENCAJADO GRANDE MASTER CARTON _____
ENCAJADO INTERMEDIO INNER CARTON _____

641090



Codo 90°

Equal elbow 90°

KOMO
EAN CODE

641090-016	16	2.0	120	10
641090-018	18	2.0	100	10
641090-020	20	2.0	90	10
641090-025	25	2.5	60	5
641090-026	26	3.0	60	5
641090-032	32	3.0	40	5

641091



Codo hembra 90°

Female equal elbow 90°

KOMO
EAN CODE

641091-01615	16 x 1/2"	2.0	150	10
641091-01620	16 x 3/4"	2.0	130	10
641091-02015	20 x 1/2"	2.0	110	10
641091-02020	20 x 3/4"	2.0	90	10
641091-02520	25 x 3/4"	2.5	60	5
641091-02525	25 x 1"	2.5	50	5
641091-02620	26 x 3/4"	3.0	60	5
641091-02625	26 x 1"	3.0	50	5
641091-03225	32 x 1"	3.0	40	5

641092



Codo macho 90°

Male equal elbow 90°

KOMO
EAN CODE

641092-01615	16 x 1/2"	2.0	180	10
641092-01620	16 x 3/4"	2.0	140	10
641092-01815	18 x 1/2"	2.0	130	10
641092-02015	20 x 1/2"	2.0	120	10
641092-02020	20 x 3/4"	2.0	100	10
641092-02520	25 x 3/4"	2.5	70	5
641092-02525	25 x 1"	2.5	60	5
641092-02620	26 x 3/4"	3.0	70	5
641092-02625	26 x 1"	3.0	60	5
641092-03225	32 x 1"	3.0	40	5

641270



Manguito acoplamiento

Straight coupling

KOMO
EAN CODE

641270-016	16	2.0	160	10
641270-018	18	2.0	130	10
641270-020	20	2.0	90	10
641270-025	25	2.5	70	5
641270-026	26	3.0	70	5
641270-032	32	3.0	45	5

CÓDIGO CODE	_____
MEDIDA SIZE	_____
ESPESOR THICKNESS	_____
ENCAJADO GRANDE MASTER CARTON	_____
ENCAJADO INTERMEDIO INNER CARTON	_____

641130



Racor te Equal tee

KOMO
EAN CODE

641130-016	16	2.0	100	10
641130-018	18	2.0	70	10
641130-020	20	2.0	60	5
641130-025	25	2.5	40	5
641130-026	26	3.0	40	5
641130-032	32	3.0	24	3

641131



Racor te hembra Female tee

KOMO
EAN CODE

641131-01615	16 x 1/2"	2.0	100	10
641131-02015	20 x 1/2"	2.0	70	10
641131-02020	20 x 3/4"	2.0	60	10
641131-02520	25 x 3/4"	2.5	50	5
641131-02525	25 x 1"	2.5	40	5
641131-02620	26 x 3/4"	3.0	50	5
641131-02625	26 x 1"	3.0	40	5
641131-03225	32 x 1"	3.0	30	3

641132



Racor te macho Male tee

KOMO
EAN CODE

641132-01615	16 x 1/2"	2.0	110	10
641132-02015	20 x 1/2"	2.0	80	10
641132-02020	20 x 3/4"	2.0	70	10
641132-02520	25 x 3/4"	2.5	50	5
641132-02620	26 x 3/4"	3.0	50	5
641132-03225	32 x 1"	3.0	30	3

641133
641134
641135



Te reducida Reducing tee

KOMO
EAN CODE

641133-01620	16 x 20 x 16	2.0 x 2.0 x 2.0	70	10
641134-01620	20 x 16 x 16	2.0 x 2.0 x 2.0	70	10
641133-02016	20 x 16 x 20	2.0 x 2.0 x 2.0	60	10
641135-02016	20 x 20 x 16	2.0 x 2.0 x 2.0	60	10
641133-02516	25 x 16 x 25	2.5 x 2.0 x 2.5	45	5
641134-02520	25 x 20 x 20	2.5 x 2.0 x 2.0	45	5
641133-02520	25 x 20 x 25	2.5 x 2.0 x 2.5	45	5
641135-02520	25 x 25 x 20	2.5 x 2.5 x 2.0	45	5
641133-02616	26 x 16 x 26	3.0 x 2.0 x 3.0	45	5
641133-02620	26 x 20 x 26	3.0 x 2.0 x 3.0	45	5
641133-03216	32 x 16 x 32	3.0 x 2.0 x 3.0	30	3
641133-03220	32 x 20 x 32	3.0 x 2.0 x 3.0	30	3
641133-03225	32 x 25 x 32	3.0 x 2.5 x 3.0	30	3
641133-03226	32 x 26 x 32	3.0 x 3.0 x 3.0	30	3

CÓDIGO CODE _____
 MEDIDA SIZE _____
 ESPESOR THICKNESS _____
 ENCAJADO GRANDE MASTER CARTON _____
 ENCAJADO INTERMEDIO INNER CARTON _____

641271



Racor recto hembra Straight female coupling

KOMO
EAN CODE

641271-01615	16 x 1/2"	2.0	200	10
641271-01620	16 x 3/4"	2.0	160	10
641271-02015	20 x 1/2"	2.0	140	10
641271-02020	20 x 3/4"	2.0	110	10
641271-02520	25 x 3/4"	2.5	80	5
641271-02525	25 x 1"	2.5	75	5
641271-02620	26 x 3/4"	3.0	80	5
641271-02625	26 x 1"	3.0	75	5
641271-03225	32 x 1"	3.0	55	5

641272



Racor recto macho Straight male coupling

KOMO
EAN CODE

641272-01615	16 x 1/2"	2.0	220	10
641272-01620	16 x 3/4"	2.0	180	10
641272-01815	18 x 1/2"	2.0	150	10
641272-02015	20 x 1/2"	2.0	150	10
641272-02020	20 x 3/4"	2.0	120	10
641272-02520	25 x 3/4"	2.5	80	5
641272-02525	25 x 1"	2.5	80	5
641272-02620	26 x 3/4"	3.0	80	5
641272-02625	26 x 1"	3.0	80	5
641272-03225	32 x 1"	3.0	60	3

641273



Manguito acoplamiento reducido Reducing straight coupling

KOMO
EAN CODE

641273-02016	20 x 16	2.0 x 2.0	110	10
641273-02520	25 x 20	2.5 x 2.0	80	5
641273-02620	26 x 20	3.0 x 2.0	80	5
641273-03225	32 x 25	3.0 x 2.5	50	5
641273-03226	32 x 26	3.0 x 3.0	50	5

641500



Racor codo mural Wall plated elbow

KOMO
EAN CODE

641500-01615	16 x 1/2"	2.0	100	10
641500-02015	20 x 1/2"	2.0	80	10
641500-02020	20 x 3/4"	2.0	60	10



MULTICAPA PRENSAR UNIVERSAL - SERIE 642 PRESS MULTILAYER UNIVERSAL - 642 SERIES

El accesorio MT de prensar para tubería multicapa ha sido diseñado específicamente para poder ser usado con diferentes tipos de perfiles de prensado: TH, H, U y Rfz.

The MT press fitting for multilayer pipes has been designed specifically to be used with different type of crimping profiles: TH, H, U and Rfz.

MULTIMORDAZA
MULTIJAW

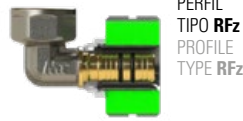
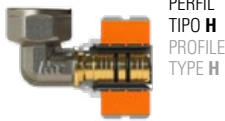
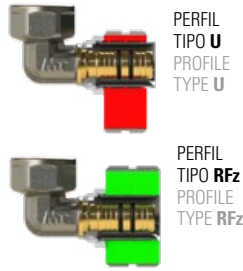
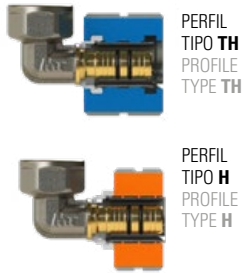

TUBO PIPE		PERFILES DE PRENSADO CRIMPING PROFILES			
Ø EXT	ESPESOR THICKNESS	TH	H	U	Rfz
16	2.0	✓	✓	✓	✓
20	2.0	✓	✓	✓	✓
25	2.5	✓	✓	✓	✓
26	3.0	✓	✓	✗	✗
32	3.0	✓	✓	✓	✓

SERIE 642
642 SERIES



FICHA TÉCNICA
TECHNICAL SHEET

CÓDIGO CODE	_____
MEDIDA SIZE	_____
ESPESOR THICKNESS	_____
ENCAJADO GRANDE MASTER CARTON	_____
ENCAJADO INTERMEDIO INNER CARTON	_____

642090



Codo 90° Equal elbow 90°

KIWA
EAN CODE

642090-016	16	2.0	100	10
642090-020	20	2.0	80	10
642090-025	25	2.5	50	5
642090-026	26	3.0	50	5
642090-032	32	3.0	30	3

642091



Codo hembra 90° Female elbow 90°

KIWA
EAN CODE

642091-01615	16 x 1/2"	2.0	100	10
642091-02015	20 x 1/2"	2.0	80	10
642091-02020	20 x 3/4"	2.0	80	10
642091-02520	25 x 3/4"	2.5	50	5
642091-02525	25 x 1"	2.5	40	5
642091-02620	26 x 3/4"	3.0	50	5
642091-02625	26 x 1"	3.0	40	5
642091-03225	32 x 1"	3.0	30	3

642092



Codo macho 90° Male elbow 90°

KIWA
EAN CODE

642092-01615	16 x 1/2"	2.0	100	10
642092-02015	20 x 1/2"	2.0	100	10
642092-02020	20 x 3/4"	2.0	80	10
642092-02520	25 x 3/4"	2.5	60	5
642092-02525	25 x 1"	2.5	50	5
642092-02620	26 x 3/4"	3.0	60	5
642092-02625	26 x 1"	3.0	50	5
642092-03225	32 x 1"	3.0	30	3

CÓDIGO CODE	_____
MEDIDA SIZE	_____
ESPESOR THICKNESS	_____
ENCAJADO GRANDE MASTER CARTON	_____
ENCAJADO INTERMEDIO INNER CARTON	_____

642130



Racor te Equal tee

KIWA
EAN CODE

642130-016	16	2.0	70	5
642130-020	20	2.0	50	5
642130-025	25	2.5	36	3
642130-026	26	3.0	36	3
642130-032	32	3.0	24	2

642131



Racor te hembra Female tee

KIWA
EAN CODE

642131-01615	16 x 1/2"	2.0	70	5
642131-02015	20 x 1/2"	2.0	60	5
642131-02020	20 x 3/4"	2.0	50	5
642131-02520	25 x 3/4"	2.5	36	3
642131-02525	25 x 1"	2.5	30	3
642131-02620	26 x 3/4"	3.0	36	3
642131-02625	26 x 1"	3.0	30	3
642131-03225	32 x 1"	3.0	24	2

642133
642134
643135



Te reducida Reducing tee

KIWA
EAN CODE

642133-01620	16 x 20 x 16	2.0 x 2.0 x 2.0	50	5
642134-01620	20 x 16 x 16	2.0 x 2.0 x 2.0	50	5
642133-02016	20 x 16 x 20	2.0 x 2.0 x 2.0	50	5
642135-02016	20 x 20 x 16	2.0 x 2.0 x 2.0	50	5
642133-02516	25 x 16 x 25	2.5 x 2.0 x 2.5	36	3
642134-02520	25 x 20 x 20	2.5 x 2.0 x 2.0	42	3
642133-02520	25 x 20 x 25	2.5 x 2.0 x 2.5	36	3
642135-02520	25 x 25 x 20	2.5 x 2.5 x 2.0	36	3
642133-02616	26 x 16 x 26	3.0 x 2.0 x 3.0	36	3
642133-02620	26 x 20 x 26	3.0 x 2.0 x 3.0	36	3
642134-02620	26 x 20 x 20	3.0 x 2.0 x 2.0	42	3
642135-02620	26 x 26 x 20	3.0 x 3.0 x 2.0	36	3
642133-03216	32 x 16 x 32	3.0 x 2.0 x 3.0	30	2
642133-03220	32 x 20 x 32	3.0 x 2.0 x 3.0	30	2
642133-03225	32 x 25 x 32	3.0 x 2.5 x 3.0	24	2
642133-03226	32 x 26 x 32	3.0 x 3.0 x 3.0	24	2

642132



Te te macho Male tee

KIWA
EAN CODE

642132-01615	16 x 1/2"	2.0	80	10
642132-02015	20 x 1/2"	2.0	60	10
642132-02020	20 x 3/4"	2.0	50	10
642132-02520	25 x 3/4"	2.5	45	5
642132-02525	25 x 1"	2.5	40	5
642132-02620	26 x 3/4"	3.0	45	5
642132-02625	26 x 1"	3.0	40	5
642132-03225	32 x 1"	3.0	24	12

642270



Manguito acoplamiento Straight coupling

KIWA
EAN CODE

642270-016	16	2.0	120	10
642270-020	20	2.0	90	10
642270-025	25	2.5	70	5
642270-026	26	3.0	70	5
642270-032	32	3.0	42	3

CÓDIGO CODE	_____
MEDIDA SIZE	_____
ESPESOR THICKNESS	_____
ENCAJADO GRANDE MASTER CARTON	_____
ENCAJADO INTERMEDIO INNER CARTON	_____

642271



Racor recto hembra Straight female coupling

KIWA
EAN CODE

642271-01615	16 x 1/2"	2.0	120	10
642271-01620	16 x 3/4"	2.0	120	10
642271-02015	20 x 1/2"	2.0	120	10
642271-02020	20 x 3/4"	2.0	100	10
642271-02520	25 x 3/4"	2.5	70	5
642271-02525	25 x 1"	2.5	60	5
642271-02620	26 x 3/4"	3.0	70	5
642271-02625	26 x 1"	3.0	60	5
642271-03225	32 x 1"	3.0	60	3

642272



Racor recto macho Straight male coupling

KIWA
EAN CODE

642272-01615	16 x 1/2"	2.0	120	10
642272-01620	16 x 3/4"	2.0	120	10
642272-02015	20 x 1/2"	2.0	120	10
642272-02020	20 x 3/4"	2.0	100	10
642272-02520	25 x 3/4"	2.5	70	5
642272-02525	25 x 1"	2.5	60	5
642272-02620	26 x 3/4"	3.0	70	5
642272-02625	26 x 1"	3.0	60	5
642272-03225	32 x 1"	3.0	60	3

642273



Manguito acoplamiento reducido Reducing straight coupling

KIWA
EAN CODE

642273-02016	20 x 16	2.0 x 2.0	100	10
642273-02520	25 x 20	2.5 x 2.0	70	5
642273-02620	26 x 20	3.0 x 2.0	70	5
642273-03225	32 x 25	3.0 x 2.5	45	3
642273-03226	32 x 26	3.0 x 3.0	45	3

642274



Racor hembra tuerca movil Loose nut female coupling

KIWA
EAN CODE

642274-01615	16 x 1/2"	2.0	120	10
642274-01620	16 x 3/4"	2.0	120	10
642274-02015	20 x 1/2"	2.0	120	10
642274-02020	20 x 3/4"	2.0	100	10
642274-02520	25 x 3/4"	2.5	70	5
642274-02525	25 x 1"	2.5	60	5
642274-02620	26 x 3/4"	3.0	70	5
642274-02625	26 x 1"	3.0	60	5
642274-03225	32 x 1"	3.0	60	3

642500



Racor codo mural Wall plated elbow

KIWA
EAN CODE

642500-01615	16 x 1/2"	2.0	70	10
642500-02015	20 x 1/2"	2.0	50	5
642500-02020	20 x 3/4"	2.0	40	5



MULTICAPA PRENSAR TIPO U - SERIE 647 PRESS MULTILAYER TYPE U - 647 SERIES



ACCESORIO DE PRENSAR PARA TUBERÍA MULTICAPA PRESS FITTING FOR MULTILAYER PIPES

- Cuerpo en latón CW617N, fabricado s/ UNE 12165.
- Compatible con tubería Multicapa de diámetros: 16x2, 20x2, 25x2.5 y 32x3.
- Temperatura máxima de trabajo: 80°C
- Presión máxima de trabajo: 10 bar

- Body in brass CW617N, according to UNE EN 12165.
- Compatible for Multilayer pipes of diameters: Ø16x2, Ø20x2, Ø25x2.5, and Ø32x3.
- Maximum working temperature : 80°C
- Maximum working pressure: 10 bar



FICHA TÉCNICA
TECHNICAL SHEET

SERIE 647
647 SERIES

CÓDIGO CODE
MEDIDA SIZE
ENCAJADO GRANDE MASTER CARTON
ENCAJADO INTERMEDIO INNER CARTON

647090



Codo 90°

Elbow 90°

AENOR

EAN CODE

647090-016	16 x 2	150	10
647090-020	20 x 2	120	10
647090-025	25 x 2,5	70	5
647090-032	32 x 3	35	5

- Disponible con anillo en blanco
Available in white ring

647091



Codo hembra

Female elbow

AENOR

EAN CODE

647091-01615	16 x 1/2"	180	10
647091-01620	16 x 3/4"	130	10
647091-02015	20 x 1/2"	130	10
647091-02020	20 x 3/4"	120	10
647091-02515	25 x 1/2"	100	5
647091-02520	25 x 3/4"	80	5
647091-02525	25 x 1"	60	5
647091-03225	32 x 1"	50	5

- Disponible con anillo en blanco
Available in white ring

647092



Codo macho 90°

Male elbow 90°

AENOR

EAN CODE

647092-01615	16 x 1/2"	200	10
647092-01620	16 x 3/4"	150	10
647092-02015	20 x 1/2"	180	10
647092-02020	20 x 3/4"	120	10
647092-02520	25 x 3/4"	90	5
647092-03225	32 x 1"	50	5

- Disponible con anillo en blanco
Available in white ring

647094



Codo tuerca movil hembra

Loose nut female elbow

AENOR

EAN CODE

647094-01615	16 x 1/2"	120	10
647094-02015	20 x 1/2"	120	10
647094-02020	20 x 3/4"	100	10
647094-02520	25 x 3/4"	60	5
647094-02525	25 x 1"	50	5
647094-03225	32 x 1"	30	5

- Disponible con anillo en blanco
Available in white ring

CÓDIGO CODE _____
MEDIDA SIZE _____
ENCAJADO GRANDE MASTER CARTON _____
ENCAJADO INTERMEDIO INNER CARTON _____

647130



Te igual Equal tee

AENOR
EAN CODE

647130-016	16 x 2,0	90	10
647130-020	20 x 2,0	60	10
647130-025	25 x 2,5	40	5
647130-032	32 x 3,0	30	5
647130-162016	16 x 20 x 16	80	10
647130-201616	20 x 16 x 16	80	10
647130-201620	20 x 16 x 20	80	10
647130-202016	20 x 20 x 16	80	10
647130-202520	20 x 25 x 20	50	5
647130-251616	25 x 16 x 16	70	5
647130-251620	25 x 16 x 20	70	5
647130-251625	25 x 16 x 25	60	5
647130-252016	25 x 20 x 16	70	5
647130-252020	25 x 20 x 20	60	5
647130-252025	25 x 20 x 25	50	5
647130-252516	25 x 25 x 16	60	5
647130-252520	25 x 25 x 20	50	5
647130-253225	25 x 32 x 25	40	5
647130-321632	32 x 16 x 32	30	5
647130-322025	32 x 20 x 25	30	5
647130-322032	32 x 20 x 32	30	5
647130-322525	32 x 25 x 25	30	5
647130-322532	32 x 25 x 32	30	5
647130-323225	32 x 32 x 25	30	5

• Disponible con anillo en blanco
Available in white ring

647131



Te hembra Female tee

AENOR
EAN CODE

647131-01615	16 x 1/2"	100	10
647131-02015	20 x 1/2"	90	10
647131-02020	20 x 3/4"	80	10
647131-02515	25 x 1/2"	40	5
647131-02520	25 x 3/4"	40	5
647131-02525	25 x 1"	50	5
647131-03220	32 x 3/4"	40	5
647131-03225	32 x 1"	30	5

• Disponible con anillo en blanco
Available in white ring

647270



Manguito acoplamiento straight coupling

AENOR
EAN CODE

647270-016	16 x 2,0	180	10
647270-020	20 x 2,0	150	10
647270-025	25 x 2,5	100	5
647270-032	32 x 3,0	60	5

• Disponible con anillo en blanco
Available in white ring

647271



Racor recto hembra Straight female coupling

AENOR
EAN CODE

647271-01615	16 x 1/2"	200	10
647271-01620	16 x 3/4"	200	10
647271-02015	20 x 1/2"	200	10
647271-02020	20 x 3/4"	150	10
647271-02515	25 x 1/2"	120	5
647271-02520	25 x 3/4"	110	5
647271-02525	25 x 1"	80	5
647271-03220	32 x 3/4"	70	5
647271-03225	32 x 1"	60	5

• Disponible con anillo en blanco
Available in white ring

CÓDIGO CODE _____
MEDIDA SIZE _____
ENCAJADO GRANDE MASTER CARTON _____
ENCAJADO INTERMEDIO INNER CARTON _____

647272



Racor recto macho Straight male coupling

AENOR
EAN CODE

647272-01610	16 x 3/8"	220	10
647272-01615	16 x 1/2"	220	10
647272-01620	16 x 3/4"	200	10
647272-02015	20 x 1/2"	210	10
647272-02020	20 x 3/4"	170	10
647272-02025	20 x 1"	100	5
647272-02515	25 x 1/2"	120	5
647272-02520	25 x 3/4"	100	5
647272-02525	25 x 1"	90	5
647272-03225	32 x 1"	60	5
647272-03232	32 x 1 1/4"	40	5

• Disponible con anillo en blanco
Available in white ring

647273



Manguito acoplamiento reducido Reducing straight coupling

AENOR
EAN CODE

647273-02016	20 x 16	150	10
647273-02516	25 x 16	110	5
647273-02520	25 x 20	100	5
647273-03220	32 x 20	80	5
647273-03225	32 x 25	75	5

• Disponible con anillo en blanco
Available in white ring

647274



Racor hembra tuerca movil Loose nut female coupling

AENOR
EAN CODE

647274-01615	16 x 1/2"	200	10
647274-01620	16 x 3/4"	200	10
647274-02015	20 x 1/2"	180	10
647274-02020	20 x 3/4"	130	10
647274-02515	25 x 1/2"	100	10
647274-02520	25 x 3/4"	100	5
647274-02525	25 x 1"	60	5
647274-03225	32 x 1"	50	5

• Disponible con anillo en blanco
Available in white ring

647275



Adaptador cu Cu connector

AENOR
EAN CODE

647275-01216	12 x 16	250	10
647275-01516	15 x 16	220	10
647275-01520	15 x 20	200	10
647275-01816	18 x 16	200	10
647275-01820	18 x 20	150	10
647275-02220	22 x 20	100	10
647275-02225	22 x 25	80	5

• Disponible con anillo en blanco
Available in white ring

647290



Tapón Cap

AENOR
EAN CODE

647290-016	16 x 2	250	10
647290-020	20 x 2	200	10
647290-025	25 x 2,5	100	5
647290-032	32 x 3	50	5

• Disponible con anillo en blanco
Available in white ring

647500



Codo mural Wall plated elbow

AENOR
EAN CODE

647500-01615	16 x 1/2"	100	10
647500-02015	20 x 1/2"	100	10
647500-02020	20 x 3/4"	80	10
647500-02520	25 x 3/4"	60	5

• Disponible con anillo en blanco
Available in white ring

VÁLVULAS MULTICAPA MULTILAYER VALVES

CÓDIGO CODE _____
MEDIDA SIZE _____
ENCAJADO GRANDE MASTER CARTON _____
ENCAJADO INTERMEDIO INNER CARTON _____

40642



Válvula esfera conexión multicapa prensar con palanca de acero inoxidable color rojo

Multilayer press ball valve with red stainless steel handle

GOLD
EAN CODE

40642-016	16 x 2.0	32	8
40642-020	20 x 2.0	32	8
40642-025	25 x 2.5	16	4
40642-026	26 x 3.0	16	4
40642-032	32 x 3.0	16	4



FICHA TÉCNICA
TECHNICAL SHEET

41642



Válvula esfera conexión multicapa prensar con mando palomilla color rojo

Multilayer press ball valve with red butterfly handle

GOLD
EAN CODE

41642-016	16 x 2.0	48	12
41642-020	20 x 2.0	48	12
41642-025	25 x 2.5	28	7
41642-026	26 x 3.0	28	7
41642-032	32 x 3.0	16	4



FICHA TÉCNICA
TECHNICAL SHEET

42642



Válvula esfera empotrar conexión multicapa prensar

Long neck multilayer press ball valve

GOLD
EAN CODE

42642-016	16 x 2.0	32	8
42642-020	20 x 2.0	32	8
42642-025	25 x 2.5	24	6
42642-026	26 x 3.0	24	6
42642-032	32 x 3.0	12	3

- Mandos disponibles en página 20
Handleless available page 20



FICHA TÉCNICA
TECHNICAL SHEET

45642

NEW



Válvula esfera conexión multicapa prensar tuerca móvil con mando palomilla color rojo

Multilayer press ball valve connection loose nut with butterfly red handle

GOLD
EAN CODE

45642-01620	16 x 2.0 x 3/4"	48	12
45642-02020	20 x 2.0 x 3/4"	48	12
45642-02520	25 x 2.5 x 3/4"	32	8
45642-02620	26 x 3.0 x 3/4"	32	8



FICHA TÉCNICA
TECHNICAL SHEET

TUBERÍA PIPELINE

CÓDIGO / CODE _____
MEDIDA INTERIOR / INNER SIZE _____
MEDIDA TUBO / PIPE SIZE _____
METROS / METERS _____

640151 ■

640152 ■

Tubo corrugado en rollo

Corrugated pipe rolls

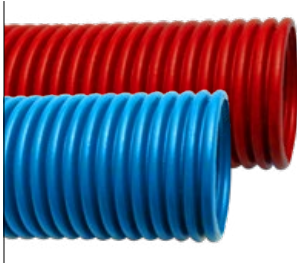

640151-016	16	26	50m
640152-016	16	26	50m
640151-020	20	32	50m
640152-020	20	32	50m
640151-025	25	40	50m
640152-025	25	40	50m

- Precio por rollo
Price per roll



FICHA TÉCNICA
TECHNICAL SHEET

CÓDIGO / CODE _____
MEDIDA / SIZE _____
ESPESOR / THICKNESS _____
METROS / METERS _____

649161 ■

649162 ■

Tubo multicapa
PE-AL-PEX aislado

Isolated multilayer
PE-AL-PEX pipe

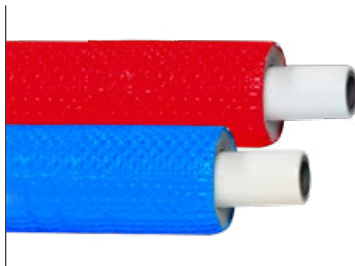

649161-016	16 x 2.0	6mm	50m
649161-020	20 x 2.0	6mm	50m
649161-025	25 x 2.5	6mm	50m
649161-032	32 x 3.0	6mm	25m
649162-016	16 x 2.0	10mm	50m
649162-020	20 x 2.0	10mm	50m
649162-025	25 x 2.5	10mm	50m
649162-032	32 x 3.0	10mm	25m

- Precio por rollo
Price per roll



FICHA TÉCNICA
TECHNICAL SHEET

CÓDIGO / CODE _____
MEDIDA / SIZE _____
METROS / METERS _____
BARRAS PAQUETE / BARS BOXES _____

640B

Tubo multicapa
PEX-AL-PEX en barra

Multilayer pipe
PEX-AL-PEX bar

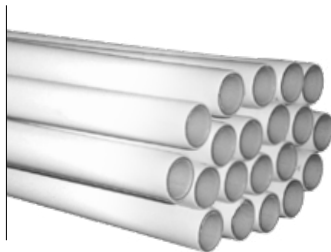

640-030216	16 x 2.0	2m	-
640-030220	20 x 2.0	2m	-
640-030225	25 x 2.5	2m	-
640-100416	16 x 2.0	4m	25
640-064420	20 x 2.0	4m	16
640-040425	25 x 2.5	4m	10
640-028432	32 x 3.0	4m	7



FICHA TÉCNICA
TECHNICAL SHEET

649B

Tubo multicapa
PE-AL-PEX en barra

Multilayer
PE-AL-PEX pipe bar



649024220	16 X 2.0	2m	24
649040216	16 X 2.0	2m	40
649080416	16 X 2.0	4m	80
649048420	20 X 2.0	4m	48
649032425	25 X 2.5	4m	32
649024432	32 X 3.0	4m	24



FICHA TÉCNICA
TECHNICAL SHEET

CÓDIGO CODE _____
MEDIDA SIZE _____
METROS METERS _____

645



Tubo PE-Xa Evoh PE-Xa en rollo

PE-Xa Evoh PE-Xa pipe rolls

645-100016	16 x 2.0	100m
645-100116*	16 x 2.0	100m
645-100020	20 x 2.0	100m
645-100120*	20 x 2.0	100m
645-050025	25 x 2.5	50m
645-050032	32 x 3.0	50m

• Precio por rollo. * Tubo PE-Xa Evoh color rojo
Price per roll. * PE-Xa pipe Evoh red colour



FICHA TÉCNICA
TECHNICAL SHEET

640R



Tubo multicapa PEX-AL-PEX en rollo

Multilayer PEX-AL-PEX pipe rolls

640-015016	16 x 2.0	15m
640-025016	16 x 2.0	25m
640-100016	16 x 2.0	100m
640-100018	18 x 2.0	100m
640-015020	20 x 2.0	15m
640-025020	20 x 2.0	25m
640-100020	20 x 2.0	100m
640-015025	25 x 2.5	15m
640-025025	25 x 2.5	25m
640-050025	25 x 2.5	50m
640-025026	26 x 3.0	25m
640-050026	26 x 3.0	50m
640-025032	32 x 3.0	25m
640-050032	32 x 3.0	50m

• Precio por rollo
Price per roll



FICHA TÉCNICA
TECHNICAL SHEET

649R



Tubo multicapa PE-Al-PEX en rollo

Multilayer PE-Al-PEX pipe rolls

649015016	16 x 2.0	15m
649015020	20 x 2.0	15m
649015025	25 x 2.5	15m
649025016	16 x 2.0	25m
649025020	20 x 2.0	25m
649025025	25 x 2.5	25m
649025032	32 X 3.0	25m
649050025	25 X 2.5	50m
649050032	32 X 3.0	50m
649100016	16 X 2.0	100m
649100020	20 X 2.0	100m



FICHA TÉCNICA
TECHNICAL SHEET

HERRAMIENTAS TOOLS

CÓDIGO / CODE _____
MEDIDA / SIZE _____
ENCAJADO GRANDE / MASTER CARTON _____
ENCAJADO INTERMEDIO / INNER CARTON _____

6400



Calibradores Gauges

6400-162026*	16-20-25/26	40	1
6400-16202632**	16-20-25/26-32	1	1

- * Imagen izquierda / Left image
- ** Imagen derecha / Right image



FICHA TÉCNICA
TECHNICAL SHEET

6402



Muelle cortatubos exterior External bending springs

6402-016	16 x 2.0	30	1
6402-018	18 x 2.0	30	1
6402-020	20 x 2.0	25	1
6402-025	25 x 2.5	20	1
6402-026	26 x 3.0	20	1
6402-032	32 x 3.0	15	1



FICHA TÉCNICA
TECHNICAL SHEET

6403



Cortatubos automático Automatic pipe cutter

6403-1242	42	50	-
-----------	----	----	---

- Medida máxima 42mm
42mm maximum size



FICHA TÉCNICA
TECHNICAL SHEET

CÓDIGO CODE _____
PERFIL PROFILE _____

MAP115MLS4



Maletín con máquina
previsar multicapa mordaza
perfil TH

Se suministra con: maletín,
máquina, cargador, batería
y mordaza + casquillos TH
16, 20, 25 ó 26, 32.

Opción: maletín en perfiles
RFz-U y H.

Press machine case TH
profile jaw

Supplied with: toolbox,
press machine, charger,
battery and clamp +
crimping profiles TH 16,
20, 25 or 26, 32.

Option: tool box with
profiles RFz-U and H.

MAP115MLS4-TH	TH
---------------	----



FICHA TÉCNICA
TECHNICAL SHEET

INSTRUCCIONES DE MONTAJE PARA ACCESORIO MULTICAPA
FITTING MULTILAYER INSTALLATION INSTRUCTIONS

1. Cortar el tubo de forma perpendicular al eje usando el cortatubos. Make a perpendicular cut in the pipe using the pipe cutter.

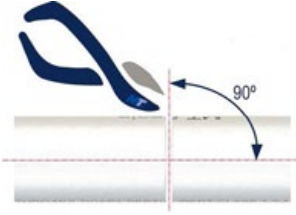

2. Calibrar el tubo. Calibrate de pipe using the gauge.



3. Insertar el extremo del tubo multicapa en el accesorio. Verificar mediante las ventanas de visualización que el tubo de ha insertado completamente. Insert the end of the multilayer pipe in the fitting. Verify by means of their viewing windows that the pipe has been inserted completely.



4. Para el prensado del accesorio, se recomienda usar una máquina con fuerza de apriete igual o superior a 15kN. For pressing the fitting, it's recommended using a pressing tool which a crimping force equal to 15kN or higher.



5. Posicionar correctamente la mordaza en el accesorio (imagen ejemplo con perfil "TH"). Place correctly the press crimp in the fitting (exemple picture using 'TH' profile).



6. Prensar completamente el accesorio. Press the fitting completely.



7. Una vez prensado, casquillo y tubería se adaptan al perfil del accesorio garantizando la estanquidad. After pressing, sleeves and pipe adapt their shapes to the fitting's profile ensuring the tightness.

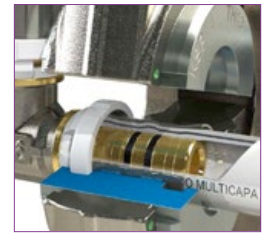



SISTEMA PEX - SERIE 651
PEX SYSTEM - 651 SERIES



FICHA TÉCNICA
TECHNICAL SHEET



CÓDIGO CODE	_____
MEDIDA SIZE	_____
ESPESOR THICKNESS	_____
ENCAJADO GRANDE MASTER CARTON	_____
ENCAJADO INTERMEDIO INNER CARTON	_____

651271Q

NEW



Racor recto hembra Female straight fitting

651271-0162015Q	12 x 1/2"	2.0	250	-
651271-0162215Q	16 x 1/2"	2.2	250	-
651271-0162020Q	16 x 3/4"	2.0	200	-

651272Q

NEW



Racor recto macho Male straight fitting

651272-0122015Q	12 x 1/2"	2.0	350	-
651272-0162015Q	16 x 1/2"	2.0	300	-
651272-0162215Q	16 x 1/2"	2.2	300	-
651272-0162020Q	12 x 3/4"	2.0	220	-
651272-0162220Q	16 x 3/4"	2.2	220	-
651272-0202015Q	20 x 1/2"	2.0	200	-
651272-0202020Q	20 x 3/4"	2.0	160	-

651091Q

NEW



Codo hembra 90° Female elbow 90°

651091-0122015Q	12 x 1/2"	2.0	180	-
651091-0162015Q	16 x 1/2"	2.0	150	-
651091-0162215Q	16 x 1/2"	2.2	150	-
651091-0202015Q	20 x 1/2"	2.0	120	-



ROSCADOS - SERIE 87
THREADED - 87 SERIES



FICHA TÉCNICA
TECHNICAL SHEET



CÓDIGO CODE _____
MEDIDA SIZE _____
ENCAJADO GRANDE MASTER CARTON _____
ENCAJADO INTERMEDIO INNER CARTON _____

87001



Curva 90° M-H

M-F Long sweep bend 90°

EAN CODE

87001-015	1/2"	120	10
87001-020	3/4"	70	10
87001-025	1"	40	5
87001-032	1 1/4"	20	5
87001-040	1 1/2"	10	5
87001-050	2"	17	1

87002



Curva 90° H-H

F-F Long sweep bend 90°

EAN CODE

87002-015	1/2"	120	10
87002-020	3/4"	70	10
87002-025	1"	40	5
87002-032	1 1/4"	20	5
87002-040	1 1/2"	10	5
87002-050	2"	17	1

87090



Codo 90° H-H

F-F elbow 90°

EAN CODE

87090-010	3/8"	340	10
87090-015	1/2"	180	10
87090-020	3/4"	110	10
87090-025	1"	60	5
87090-032	1 1/4"	35	5
87090-040	1 1/2"	30	5
87090-050	2"	36	1
87090-065	2 1/2"	16	1
87090-080	3"	12	1
87090-100	4"	4	1

87090R



Codo 90° reducido H-H

F-F reducing elbow 90°

EAN CODE

87090-01510	1/2" x 3/8"	230	10
87090-02015	3/4" x 1/2"	130	10
87090-02515	1" x 1/2"	100	5
87090-02520	1" x 3/4"	75	5
87090-03225	1 1/4" x 1"	50	5
87090-04025	1 1/2" x 1"	40	5
87090-04032	1 1/2" x 1 1/4"	30	5

87092



Codo 90° M-H

M-F Elbow 90°

EAN CODE

87092-010	3/8"	280	10
87092-015	1/2"	200	10
87092-020	3/4"	100	10
87092-025	1"	60	5
87092-032	1 1/4"	35	5
87092-040	1 1/2"	25	5
87092-050	2"	32	1
87092-065	2 1/2"	17	1
87092-080	3"	12	1

- Rosca macho paralela
Parallel male thread

CÓDIGO CODE _____
MEDIDA SIZE _____
ENCAJADO GRANDE MASTER CARTON _____
ENCAJADO INTERMEDIO INNER CARTON _____

87093



Codo 90° M-M

M-M Elbow 90°

EAN CODE

87093-010	3/8"	480	10
87093-015	1/2"	240	10
87093-020	3/4"	120	10

- Rosca macho paralela
Parallel male thread

87098



Codo 90° M-H con conector
dos piezas

M-F elbow 90° with two
pieces connector

EAN CODE

87098-015	1/2"	100	10
87098-020	3/4"	60	10
87098-025	1"	30	5

- Rosca macho paralela
Parallel male thread

87130



Te igual H

F equal tee

EAN CODE

87130-010	3/8"	180	10
87130-015	1/2"	120	10
87130-020	3/4"	60	10
87130-025	1"	45	5
87130-032	1 1/4"	25	5
87130-040	1 1/2"	20	5
87130-050	2"	26	1
87130-065	2 1/2"	12	1
87130-080	3"	6	1
87130-100	4"	4	1

87130R



Te reducida H

F reducing tee

EAN CODE

87130-01510	1/2" x 3/8"	130	10
87130-02015	3/4" x 1/2"	90	10
87130-02515	1" x 1/2"	60	5
87130-02520	1" x 3/4"	50	5
87130-03215	1 1/4" x 1/2"	40	5
87130-03220	1 1/4" x 3/4"	30	5
87130-03225	1 1/4" x 1"	30	5
87130-04015	1 1/2" x 1/2"	25	5
87130-04020	1 1/2" x 3/4"	25	5
87130-04025	1 1/2" x 1"	25	5
87130-04032	1 1/2" x 1 1/4"	20	5
87130-05015	2" x 1/2"	42	1
87130-05020	2" x 3/4"	42	1
87130-05025	2" x 1"	42	1
87130-05032	2" x 1 1/4"	36	1

87132



Te igual macho

M equal tee

EAN CODE

87132-015	1/2"	200	10
87132-020	3/4"	90	10

- Rosca macho paralela
Parallel male thread

CÓDIGO CODE _____
MEDIDA SIZE _____
ENCAJADO GRANDE MASTER CARTON _____
ENCAJADO INTERMEDIO INNER CARTON _____

87180



Cruz H F cross

EAN CODE

87180-010	3/8"	200	10
87180-015	1/2"	110	10
87180-020	3/4"	60	10
87180-025	1"	35	5
87180-032	1 1/4"	20	5
87180-040	1 1/2"	15	5
87180-050	2"	18	1

87240



Manguito reducción H-H F-F reducing socket

EAN CODE

87240-01510	1/2" x 3/8"	300	10
87240-02010	3/4" x 3/8"	250	10
87240-02015	3/4" x 1/2"	210	10
87240-02515	1" x 1/2"	160	5
87240-02520	1" x 3/4"	150	5
87240-03225	1 1/4" x 1"	90	5
87240-04025	1 1/2" x 1"	70	5
87240-04032	1 1/2" x 1 1/4"	60	5
87240-05025	2" x 1"	76	1
87240-05032	2" x 1 1/4"	76	1
87240-05040	2" x 1 1/2"	76	1

87241



Tuerca reducción M-H M-F reducing bushings

EAN CODE

87241-01008*	3/8" x 1/4"	800	10
87241-01506*	1/2" x 1/8"	600	10
87241-01508*	1/2" x 1/4"	500	10
87241-01510*	1/2" x 3/8"	500	10
87241-02010*	3/4" x 3/8"	400	10
87241-02015*	3/4" x 1/2"	300	10
87241-02515*	1" x 1/2"	200	5
87241-02520*	1" x 3/4"	200	5
87241-03220*	1 1/4" x 3/4"	140	5
87241-03225*	1 1/4" x 1"	140	5
87241-04025**	1 1/2" x 1"	115	5
87241-04032**	1 1/2" x 1 1/4"	115	5
87241-05025**	2" x 1"	140	1
87241-05032**	2" x 1 1/4"	140	1
87241-05040**	2" x 1 1/2"	120	1
87241-06532**	2 1/2" x 1 1/4"	90	1
87241-06540**	2 1/2" x 1 1/2"	90	1
87241-06550**	2 1/2" x 2"	90	1
87241-08050**	3" x 2"	56	1
87241-08065**	3" x 2 1/2"	56	1
87241-10050**	4" x 2"	26	1
87241-10065**	4" x 2 1/2"	26	1
87241-10080**	4" x 3"	26	1

- * Hexagonal / Hexagonal
- ** Octogonal / Octagonal
- Rosca macho paralela
Parallel male thread

CÓDIGO CODE _____
 MEDIDA SIZE _____
 ENCAJADO GRANDE MASTER CARTON _____
 ENCAJADO INTERMEDIO INNER CARTON _____

87245



Machón reducido M-M

M-M reducing nipple

EAN CODE

87245-01008*	3/8" x 1/4"	600	10
87245-01508*	1/2" x 1/4"	400	10
87245-01510*	1/2" x 3/8"	500	10
87245-02010*	3/4" x 3/8"	280	10
87245-02015*	3/4" x 1/2"	270	10
87245-02515*	1" x 1/2"	160	5
87245-02520*	1" x 3/4"	150	5
87245-03220*	1 1/4" x 3/4"	100	5
87245-03225*	1 1/4" x 1"	95	5
87245-04025**	1 1/2" x 1"	80	5
87245-04032**	1 1/2" x 1 1/4"	70	5
87245-05025**	2" x 1"	120	1
87245-05032**	2" x 1 1/4"	120	1
87245-05040**	2" x 1 1/2"	96	1

- * Hexagonal / Hexagonal
- ** Octogonal / Octagonal
- Rosca macho paralela
Parallel male thread

87246



Manguito reducción M-H

M-F reducing nipple socket

EAN CODE

87246-00810*	1/4" x 3/8"	500	10
87246-01008*	3/8" x 1/4"	750	10
87246-01015*	3/8" x 1/2"	400	10
87146-01020*	3/8" x 3/4"	180	10
87246-01510*	1/2" x 3/8"	500	10
87246-01520*	1/2" x 3/4"	280	10
87246-01525*	1/2" x 1"	180	10
87246-02015*	3/4" x 1/2"	280	10
87246-02025*	3/4" x 1"	160	10
87246-02520*	1" x 3/4"	150	5
87246-02532**	1" x 1 1/4"	105	5
87246-02540**	1" x 1 1/2"	75	5
87246-02550**	1" x 2"	115	5
87246-03240**	1 1/4" x 1 1/2"	70	5
87246-03250**	1 1/4" x 2"	110	5
87246-04050**	1 1/2" x 2"	110	5

- * Hexagonal / Hexagonal
- ** Octogonal / Octagonal
- Rosca macho paralela
Parallel male thread

87270



Manguito H-H

F-F socket

EAN CODE

87270-010	3/8"	400	10
87270-015	1/2"	230	10
87270-020	3/4"	140	10
87270-025	1"	100	10
87270-032	1 1/4"	55	5
87270-040	1 1/2"	35	5
87270-050	2"	45	1
87270-065	2 1/2"	30	1
87270-080	3"	21	1
87270-100	4"	12	1

- Rosca macho paralela
Parallel male thread

87271

Manguito anti-electrolisis
H-H

F-F Antielectrolitic socket

EAN CODE

87271-015	1/2"	250	25
87271-020	3/4"	200	15
87271-025	1"	70	10
87271-032	1 1/4"	45	1
87271-040	1 1/2"	30	1
87271-050	2"	20	1

CÓDIGO CODE _____
MEDIDA SIZE _____
ENCAJADO GRANDE MASTER CARTON _____
ENCAJADO INTERMEDIO INNER CARTON _____

87272

NEW



Manguito antielectrólisis M-H M-F Antielectrolytic socket

EAN CODE

87272-015	1/2"	200	20
-----------	------	-----	----

87280



Machón M-M M-M hexagon nipple

EAN CODE

87280-008*	1/4"	800	10
87280-010*	3/8"	500	10
87280-015*	1/2"	300	10
87280-020*	3/4"	200	10
87280-025*	1"	120	5
87280-032*	1 1/4"	75	5
87280-040**	1 1/2"	60	5
87280-050**	2"	96	1
87280-065**	2 1/2"	45	1
87280-080**	3"	32	1
87280-100**	4"	12	1

- * Hexagonal / Hexagonal
- ** Octogonal / Octagonal
- Rosca macho paralela
Parallel male thread

87290



Tapón macho con reborde M plug beaded

EAN CODE

87290-008*	1/4"	900	10
87290-010*	3/8"	600	10
87290-015*	1/2"	470	10
87290-020*	3/4"	300	10
87290-025*	1"	200	5
87290-032*	1 1/4"	120	5
87290-040*	1 1/2"	110	5
87290-050*	2"	160	1
87290-065**	2 1/2"	84	1
87290-080**	3"	56	1
87290-100**	4"	24	1

- * Hexagonal / Hexagonal
- ** Octogonal / Octagonal
- Rosca macho paralela
Parallel male thread

87300



Tapón hexagonal H F hexagon cap

EAN CODE

87300-010*	3/8"	600	10
87300-015*	1/2"	430	10
87300-020*	3/4"	300	10
87300-025*	1"	200	5
87300-032**	1 1/4"	150	5
87300-040**	1 1/2"	110	5
87300-050**	2"	135	1

- * Hexagonal / Hexagonal
- ** Octogonal / Octagonal
- Rosca macho paralela
Parallel male thread

CÓDIGO CODE _____
 MEDIDA SIZE _____
 ENCAJADO GRANDE MASTER CARTON _____
 ENCAJADO INTERMEDIO INNER CARTON _____

87318



Te cinco vías Five way tee

EAN CODE

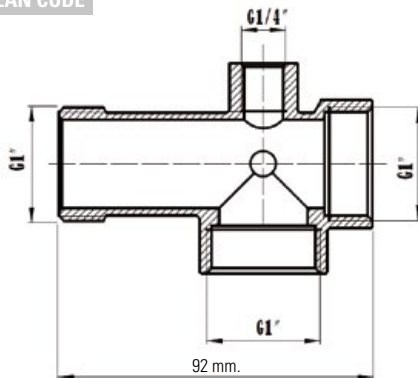

87318-025	1"	30	5
-----------	----	----	---

- Rosca macho paralela
Parallel male thread

87315



Entronque manguera Hexagon hose nipple

EAN CODE

87315-00810	1/4" x 10	600	10
87315-00812	1/4" x 12	350	10
87315-01012	3/8" x 12	300	10
87315-01512	1/2" x 12	300	10
87315-01514	1/2" x 14	280	10
87315-01516	1/2" x 16	240	10
87315-01518	1/2" x 18	230	10
87315-01520	1/2" x 20	190	10
87315-02020	3/4" x 20	140	10
87315-02025	3/4" x 25	120	10
87315-02525	1" x 25	100	5
87315-02530	1" x 30	80	5
87315-03230	1 1/4" x 30	50	5
87315-03235	1 1/4" x 35	50	5
87315-03238	1 1/4" x 38	40	5
87315-03240	1 1/4" x 40	40	5
87315-04038	1 1/2" x 38	30	5
87315-04045	1 1/2" x 45	30	5
87315-04050	1 1/2" x 50	20	5
87315-05060	2" x 60	33	1

- Rosca macho paralela
Parallel male thread

87340



Tuerca unión asiento cónico H-H F-F Straight union tapered seat

EAN CODE

87340-015*	1/2"	140	10
87340-020*	3/4"	80	10
87340-025*	1"	60	5
87340-032**	1 1/4"	30	5
87340-040**	1 1/2"	25	5
87340-050**	2"	30	1

- * Hexagonal / Hexagonal
** Octogonal / Octogonal

87341



Tuerca unión asiento cónico M-H M-F Straight union tapered seat

EAN CODE

87341-015*	1/2"	120	10
87341-020*	3/4"	70	10
87341-025*	1"	45	5
87341-032**	1 1/4"	30	5
87341-040**	1 1/2"	20	5
87341-050**	2"	24	1

- * Hexagonal / Hexagonal
** Octogonal / Octogonal
- Rosca macho paralela
Parallel male thread

CÓDIGO CODE _____
MEDIDA SIZE _____
ENCAJADO GRANDE MASTER CARTON _____
ENCAJADO INTERMEDIO INNER CARTON _____

873412



Tuerca unión tres piezas
latón M-H asiento cónico
con junta

M-F three pieces brass
straight union tapered seat
with o-ring

EAN CODE

873412-015*	1/2"	130	10
873412-020*	3/4"	80	10
873412-025*	1"	50	5
873412-032*	1 1/4"	30	5
873412-040**	1 1/2"	20	5
873412-050**	2"	12	1

- * Hexagonal / Hexagonal
- ** Octogonal / Octagonal
- Rosca macho paralela
Parallel male thread

87529



Manguito igual M-H "tipo
Marsella"

M-F Equal socket 'Marsella
type'

EAN CODE

87529-008	1/4"	800	10
87529-010	3/8"	500	10
87529-015	1/2"	320	10
87529-020	3/4"	220	10
87529-025	1"	110	5
87529-032	1 1/4"	80	5
87529-040	1 1/2"	50	5
87529-050	2"	70	1

- Rosca macho paralela
Parallel male thread

87530



Manguito igual M-H
(hexágono interior)

M-F Equal socket (hexagon
inside)

EAN CODE

87530-1502	1/2" x 2 cm.	250	10
------------	--------------	-----	----

- Rosca macho paralela
Parallel male thread

87531



Manguito igual M-H
(hexágono interior)

M-F equal socket (hexagon
inside)

EAN CODE

87531-015	1/2" x 1 cm	250	10
-----------	-------------	-----	----

- Rosca macho paralela
Parallel male thread

87532



Manguito igual M-H

M-F Equal socket

EAN CODE

87532-01503	1/2" x 3 cm.	250	10
-------------	--------------	-----	----

- Rosca macho paralela
Parallel male thread

87533



Alargadera acabado latón
M-H (hexágono interior)

M-F extension fitting brass
finish (hexagon inside)

EAN CODE

87533-015020	1/2" x 20 mm.	300	10
87533-015030	1/2" x 30 mm.	200	10
87533-015050	1/2" x 50 mm.	130	5
87533-015100	1/2" x 100 mm.	90	5
87533-020050	3/4" x 50 mm.	90	5
87533-020100	3/4" x 100 mm.	60	5

- Rosca macho paralela
Parallel male thread

CÓDIGO CODE _____
 MEDIDA SIZE _____
 ENCAJADO GRANDE MASTER CARTON _____
 ENCAJADO INTERMEDIO INNER CARTON _____

87563



Racor hembra dos piezas
manguera H Female two pieces hose
nipple

EAN CODE

87563-01514	1/2" x 14	300	10
87563-02020	3/4" x 20	180	10
87563-02525	1" x 25	100	5
87563-03230	1 1/4" x 30	80	5
87563-03235	1 1/4" x 35	80	5
87563-04040	1 1/2" x 40	50	1

87575



Anillo reducido M-H M-F equal socket

EAN CODE

87575-01510	1/2" x 3/8"	450	10
87575-02015	3/4" x 1/2"	280	10

- Rosca macho paralela
Parallel male thread

87550



Racor depósito con tuerca
corredera Tank outlet connection

EAN CODE

87550-010	3/8"	180	10
87550-015	1/2"	120	10
87550-020	3/4"	80	10
87550-025	1"	50	5
87550-032	1 1/4"	30	5
87550-040	1 1/2"	25	1
87550-050	2"	30	1
87550-065	2 1/2"	22	1
87550-080	3"	10	1

87551

NEW



Tuerca corredera Sliding nut

EAN CODE

87551-010	3/8"	1000	10
87551-015	1/2" x 6.5	800	10
87551-020	3/4" x 6.5	500	10
87551-025	1" x 7.5	350	10
87551-032	1 1/4"	100	10

87500



Racor codo mural Wall plated elbow

EAN CODE

87500015	1/2"	140	10
----------	------	-----	----

87570



Racor express manguera Hose express connection

EAN CODE

87570-016	16	100	10
87570-022	22	70	10

- Disponible hasta agotar existencias
While stocks lasts

CÓDIGO CODE _____
MEDIDA SIZE _____
ENCAJADO GRANDE MASTER CARTON _____
ENCAJADO INTERMEDIO INNER CARTON _____

87560



Racor Barcelona manguera
Hose coupling Barcelona
hose-hose
EAN CODE

87560-020	20 x 20	120	10
87560-025	25 x 25	60	10
87560-030	30 x 30	40	5
87560-035	35 x 35	25	5
87560-040	40 x 40	22	1
87560-045	45 x 45	13	1
87560-050	50 x 50	22	1
87560-060	60 x 60	15	1

87561



Racor Barcelona M-M
M-M Hose coupling
Barcelona
EAN CODE

87561-015	1/2" x 1/2"	150	10
87561-020	3/4" x 3/4"	110	10
87561-025	1" x 1"	70	5
87561-032	1 1/4" x 1 1/4"	35	5
87561-040	1 1/2" x 1 1/2"	22	1
87561-050	2" x 2"	24	1

87562



Racor Barcelona macho
manguera
M hose coupling Barcelona
hose
EAN CODE

87562-1520	1/2" x 20	140	10
87562-2025	3/4" x 25	80	10
87562-2530	1" x 30	50	5
87562-3235	1 1/4" x 35	30	5
87562-4045	1 1/2" x 45	18	1
87562-5060	2" x 60	20	1

- **Recambios** disponibles en página 221
Spare parts available page 221

TABLA RECAMBIO JUNTAS (RACOR BARCELONA) GASKETS SPARE PARTS TABLE (HOSE BARCELONA)

RACOR BARCELONA HOSE BARCELONA	JUNTA O'RING	MEDIDA SIZE
87560-020		
87561-015	DN15	97900-015
87562-1520		
87560-025		
87561-020	DN20	97900-020
87562-2025		
87560-030		
87561-025	DN25	97900-025
87562-2530		
87560-035		
87560-040	DN32	97900-032
87561-032		
87562-3235		
87560-045		
87561-040	DN40	97900-040
87562-4045		
87560-050	50mm.	97900-050mm.
87560-060		
87561-050	DN50	97900-050
87562-5060		

CÓDIGO CODE
MEDIDA SIZE
ENCAJADO GRANDE MASTER CARTON
ENCAJADO INTERMEDIO INNER CARTON

82130



Conexión gas te

Tee gas connection

EAN CODE

82130-008

8mm.

400

10

82220



Conexión gas Y

Y gas connection

EAN CODE

82220-008

8mm.

400

10

82270



Manguito conexión gas

Gas connection socket

EAN CODE

82270-008

8mm.

800

10



ROSCADOS CROMADOS - SERIE 871
CHROMED PLATED THREADED - 871 SERIES



FICHA TÉCNICA
TECHNICAL SHEET



CÓDIGO CODE _____
MEDIDA SIZE _____
ENCAJADO GRANDE MASTER CARTON _____
ENCAJADO INTERMEDIO INNER CARTON _____

871090



Codo 90° H-H

F-F elbow 90°

EAN CODE

871090-010	3/8"	340	10
871090-015	1/2"	180	10
871090-020	3/4"	110	10
871090-025	1"	60	5

871092



Codo 90° M-H

M-F Elbow 90°

EAN CODE

871092-010	3/8"	280	10
871092-015	1/2"	200	10
871092-020	3/4"	100	10
871092-025	1"	60	5

- Rosca macho paralela
Parallel male thread

871500



Racor codo mural H-H

F-F wall plated elbow

EAN CODE

871500-015	1/2"	140	10
------------	------	-----	----

871130



Te igual H

F equal tee

EAN CODE

871130-010	3/8"	150	10
871130-015	1/2"	120	10
871130-020	3/4"	60	10
871130-025	1"	45	5

871240



Manguito reducción H-H

F-F reducing socket

EAN CODE

871240-01510	1/2" x 3/8"	300	10
871240-02015	3/4" x 1/2"	210	10

CÓDIGO CODE _____
MEDIDA SIZE _____
ENCAJADO GRANDE MASTER CARTON _____
ENCAJADO INTERMEDIO INNER CARTON _____

871241



Tuerca reducción M-H M-F reducing bushings

EAN CODE

871241-01510*	1/2" x 3/8"	500	10
871241-02015*	3/4" x 1/2"	300	10

- * Hexagonal / Hexagonal
- ** Octogonal / Octagonal
- Rosca macho paralela
Parallel male thread

871245



Machón reducido M-M M-M reducing nipple

EAN CODE

871245-01510	1/2" x 3/8"	500	10
871245-02015	3/4" x 1/2"	270	10

- * Hexagonal / Hexagonal
- ** Octogonal / Octagonal
- Rosca macho paralela
Parallel male thread

871246



Manguito reducción M-H M-F reducing nipple socket

EAN CODE

871246-01015	3/8" x 1/2"	400	10
871246-01510	1/2" x 3/8"	500	10
871246-01520	1/2" x 3/4"	280	10
871246-02015	3/4" x 1/2"	280	10
871246-02520	1" x 3/4"	150	5

- * Hexagonal / Hexagonal
- ** Octogonal / Octagonal
- Rosca macho paralela
Parallel male thread

871270



Manguito H-H F-F socket

EAN CODE

871270-010	3/8"	400	10
871270-015	1/2"	230	10
871270-020	3/4"	140	10
871270-025	1"	100	10

- Rosca macho paralela
Parallel male thread

871280



Machón M-M M-M hexagon nipple

EAN CODE

871280-010	3/8"	500	10
871280-015	1/2"	300	10
871280-020	3/4"	200	10
871280-025	1"	120	5

- * Hexagonal / Hexagonal
- ** Octogonal / Octagonal
- Rosca macho paralela
Parallel male thread

871300

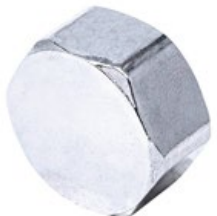

Tapón hexagonal H F hexagon cap

EAN CODE

871300-010	3/8"	600	10
871300-015	1/2"	430	10
871300-020	3/4"	300	10
871300-025	1"	200	5

CÓDIGO CODE _____
MEDIDA SIZE _____
ENCAJADO GRANDE MASTER CARTON _____
ENCAJADO INTERMEDIO INNER CARTON _____

871290



Tapón macho con reborde M plug beaded

EAN CODE

871290-010	3/8"	600	10
871290-015	1/2"	470	10
871290-020	3/4"	300	10
871290-025	1"	200	5

- Rosca macho paralela
Parallel male thread

871529



Manguito igual M-H "tipo Marsella" M-F Equal socket 'Marsella type'

EAN CODE

871529-010	3/8"	500	10
871529-015	1/2"	320	10
871529-020	3/4"	220	10
871529-025	1"	110	5

- Rosca macho paralela
Parallel male thread

871531



Manguito igual M-H "tipo Marsella" M-F equal socket 'Marsella type'

EAN CODE

871531-015	1/2" x 1 cm	250	10
------------	-------------	-----	----

- Rosca macho paralela
Parallel male thread

87534



Alargadera acabado latón M-F extension fitting brass finish (hexagon inside)

EAN CODE

87534-015020	1/2" x 20 mm.	225	25
87534-015050	1/2" x 50 mm.	120	5
87534-015100	1/2" x 100 mm.	90	5

- Rosca macho paralela
Parallel male thread



TUBERÍA CU - SERIE 86
CU PIPE - 86 SERIES



FICHA TÉCNICA
TECHNICAL SHEET



CÓDIGO CODE _____
MEDIDA SIZE _____
ENCAJADO GRANDE MASTER CARTON _____
ENCAJADO INTERMEDIO INNER CARTON _____

86090



Codo H-Cu F-Cu elbow

EAN CODE

86090-1215	12 x 1/2"	300	25
86090-1415	14 x 1/2"	300	25
86090-1515	15 x 1/2"	250	25
86090-1815	18 x 1/2"	250	25
86090-1820	18 x 3/4"	160	10
86090-2215	22 x 1/2"	160	10
86090-2220	22 x 3/4"	130	10
86090-2820	28 x 3/4"	90	10
86090-2825	28 x 1"	70	5

86092



Codo M-Cu M-Cu elbow

EAN CODE

86092-1215	12 x 1/2"	325	25
86092-1415	14 x 1/2"	300	25
86092-1515	15 x 1/2"	300	25
86092-1815	18 x 1/2"	250	25
86092-2215	22 x 1/2"	160	10
86092-2220	22 x 3/4"	130	10

- Rosca macho paralela
Parallel male thread

86130



Te H-Cu F-Cu tee

EAN CODE

86130-1215	12 x 1/2"	275	25
86130-1415	14 x 1/2"	250	25
86130-1515	15 x 1/2"	250	25
86130-1815	18 x 1/2"	150	10
86130-2215	22 x 1/2"	120	10
86130-2820	28 x 3/4"	60	5

86180



Cruz Cu Cu equal cross

EAN CODE

86180-015	15	200	10
86180-018	18	130	10
86180-022	22	80	10
86180-028	28	40	5

86472



Codo mural H-Cu F-Cu Wall plated elbow

EAN CODE

86472-1215	12 x 1/2"	240	10
86472-1415	14 x 1/2"	220	10
86472-1515	15 x 1/2"	220	10
86472-1820	18 x 3/4"	120	10
86472-2215	22 x 1/2"	120	10
86472-2220	22 x 3/4"	110	10

CÓDIGO CODE
MEDIDA SIZE
ENCAJADO GRANDE MASTER CARTON
ENCAJADO INTERMEDIO INNER CARTON

86243



Entronque M-Cu M-Cu Straight connector

EAN CODE

86243-1215	12 x 1/2"	400	25
86243-1415	14 x 1/2"	400	25
86243-1515	15 x 1/2"	400	25
86243-1520	15 x 3/4"	350	25
86243-1815	18 x 1/2"	350	25
86243-1820	18 x 3/4"	300	25
86243-2220	22 x 3/4"	250	10
86243-2225	22 x 1"	180	10
86243-2820	28 x 3/4"	190	10
86243-2825	28 x 1"	160	10
86243-3532*	35 x 1 1/4"	100	5

- Rosca macho paralela
Parallel male thread
- *Disponibile hasta agotar existencias
*While stocks lasts

86270



Enlace H-Cu F-Cu Straight connector

EAN CODE

86270-1215	12 x 1/2"	500	25
86270-1415	14 x 1/2"	475	25
86270-1515	15 x 1/2"	350	25
86270-1520	15 x 3/4"	300	25
86270-1815	18 x 1/2"	375	25
86270-1820	18 x 3/4"	275	25
86270-2215	22 x 1/2"	300	25
86270-2220	22 x 3/4"	200	10
86270-2225	22 x 1"	150	10
86270-2820	28 x 3/4"	150	10
86270-2825	28 x 1"	110	10

86301



Tapón Cu Cu cap

EAN CODE

86301-012	12	600	25
86301-014	14	1050	25
86301-015	15	500	25
86301-018	18	500	10
86301-022	22	400	10
86301-028	28	200	5

86359



Racor dos piezas recto H-Cu F-Cu straight tap connection

EAN CODE

86359-1215	12 x 1/2"	350	25
86359-1415	14 x 1/2"	325	25
86359-1515	15 x 1/2"	325	25
86359-1520	15 x 3/4"	250	25
86359-1815	18 x 1/2"	250	25
86359-1820	18 x 3/4"	190	10
86359-1825	18 x 1"	130	10
86359-2215	22 x 1/2"	210	10
86359-2220	22 x 3/4"	160	10
86359-2225	22 x 1"	120	10
86359-2825	28 x 1"	90	10

- Asiento plano
Flat seat
- Junta plana de fibra incluida
Fiber flat gasket included

CÓDIGO CODE _____
MEDIDA SIZE _____
ENCAJADO GRANDE MASTER CARTON _____
ENCAJADO INTERMEDIO INNER CARTON _____

86361



Racor dos piezas
curvo H-Cu

F-Cu bed tap connection

EAN CODE

86361-1215	12 x 1/2"	300	25
86361-1415	14 x 1/2"	275	25
86361-1515	15 x 1/2"	225	25
86361-1520	15 x 3/4"	150	25
86361-1815	18 x 1/2"	250	25
86361-1820	18 x 3/4"	140	10
86361-1825	18 x 1"	90	10
86361-2215	22 x 1/2"	140	10
86361-2220	22 x 3/4"	130	10
86361-2225	22 x 1"	70	10

- Asiento plano
Flat seat
- Junta plana de fibra incluida
Fiber flat gasket included

86362



Abrazadera tapaporos

Brass sealing clamp

EAN CODE

86362-010	10	150	10
86362-012	12	140	10
86362-015	15	90	10
86362-018	18	80	10
86362-022	22	50	10
86362-028	28	40	5
86362-035	35	25	5
86362-042	42	15	5
86362-054	54	10	5

- Para tubo cobre hidrosanitario e inoxidable
Hydrosanitary copper and stainless steel pipes

86363



Abrazadera tapaporos con
derivación

Brass sealing clamp with
female threaded outlet

EAN CODE

86363-01515	15 x 1/2"	80	10
86363-01815	18 x 1/2"	70	10
86363-02215	22 x 1/2"	50	10
86363-02820	28 x 3/4"	30	5
86363-03520	35 x 3/4"	25	5
86363-04225	42 x 1"	15	5
86363-05432	54 x 1 1/4"	10	5

- Para tubo cobre hidrosanitario e inoxidable
Hydrosanitary copper and stainless steel pipes



PE - TUERCA HEMBRA - SERIE 88
PE - FEMALE NUT - 88 SERIES



FICHA TÉCNICA
TECHNICAL SHEET



CÓDIGO CODE _____
MEDIDA SIZE _____
ENCAJADO GRANDE MASTER CARTON _____
ENCAJADO INTERMEDIO INNER CARTON _____

88010

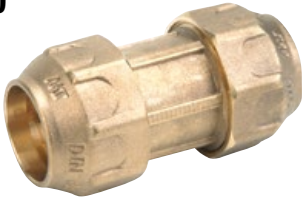

Manguito acoplamiento PE-PE PE-PE straight coupling

DVGW

EAN CODE

88010-020	20	80	10
88010-025	25	50	10
88010-032	32	30	5
88010-040	40	20	2
88010-050	50	13	1
88010-063	63	14	1

- Tope DN20-DN40; Sin tope DN50-DN63
Stopper DN20-DN40; without stopper DN50-DN63

88030



Codo 90° PE-PE PE-PE elbow 90°

DVGW

EAN CODE

88030-020	20	70	10
88030-025	25	40	10
88030-032	32	25	5
88030-040	40	14	2
88030-050	50	9	1
88030-063	63	10	1

88050



Racor te igual PE-PE equal tee

DVGW

EAN CODE

88050-020	20	40	10
88050-025	25	30	10
88050-032	32	15	5
88050-040	40	10	2
88050-050	50	6	1
88050-063	63	7	1

88090



Racor recto macho PE-M PE-M male coupling

DVGW

EAN CODE

88090-02015	20 x 1/2"	140	10
88090-02520	25 x 3/4"	90	10
88090-03225	32 x 1"	50	5
88090-04032	40 x 1 1/4"	30	2
88090-05040	50 x 1 1/2"	18	1
88090-06350	63 x 2"	22	1

- Rosca macho cónica
Tapered male thread

88110



Racor recto hembra PE-H PE-F Female coupling

DVGW

EAN CODE

88110-02015	20 x 1/2"	120	10
88110-02520	25 x 3/4"	70	10
88110-03225	32 x 1"	45	5
88110-04032	40 x 1 1/4"	30	2
88110-05040	50 x 1 1/2"	20	1
88110-06350	63 x 2"	25	1

CÓDIGO CODE _____
MEDIDA SIZE _____
ENCAJADO GRANDE MASTER CARTON _____
ENCAJADO INTERMEDIO INNER CARTON _____

88130



Codo 90° macho PE-M PE-M Male elbow 90°

DVGW

EAN CODE

88130-02015	20 x 1/2"	90	10
88130-02520	25 x 3/4"	60	10
88130-03225	32 x 1"	40	5
88130-04032	40 x 1 1/4"	22	2
88130-05040	50 x 1 1/2"	13	1
88130-06350	63 x 2"	15	1

- Rosca macho cónica
Tapered male thread

88150



Codo 90° hembra PE-H PE-F Female elbow 90°

DVGW

EAN CODE

88150-02015	20 x 1/2"	90	10
88150-02520	25 x 3/4"	50	10
88150-03225	32 x 1"	35	5
88150-04032	40 x 1 1/4"	24	2
88150-05040	50 x 1 1/2"	13	1
88150-06350	63 x 2"	14	1

88170



Racor te macho PE-M PE-M male tee

DVGW

EAN CODE

88170-02015	20 x 1/2"	60	10
88170-02520	25 x 3/4"	30	10
88170-03225	32 x 1"	20	5
88170-04032	40 x 1 1/4"	10	2
88170-05040	50 x 1 1/2"	7	1
88170-06350	63 x 2"	9	1

- Rosca macho cónica
Tapered male thread

88190



Racor te hembra PE-H PE-F female tee

DVGW

EAN CODE

88190-02015	20 x 1/2"	60	10
88190-02520	25 x 3/4"	30	10
88190-03225	32 x 1"	20	5
88190-04032	40 x 1 1/4"	10	2
88190-05040	50 x 1 1/2"	7	1
88190-06350	63 x 2"	9	1

88500



Racor codo mural Wall plated elbow

DVGW

EAN CODE

88500-02015	20 x 1/2"	60	10
88500-02520	25 x 3/4"	40	10
88500-03225	32 x 1"	25	5



PE - TUERCA MACHO - SERIE 99
PE - MALE NUT - 99 SERIES

FICHA TÉCNICA
TECHNICAL SHEET



CÓDIGO CODE _____
MEDIDA SIZE _____
ENCAJADO GRANDE MASTER CARTON _____
ENCAJADO INTERMEDIO INNER CARTON _____

99010



Manguito acoplamiento PE-PE PE-PE straight coupling

ACS
EAN CODE

99010-020	20	80	10
99010-025	25	50	10
99010-032	32	35	5
99010-040	40	24	2
99010-050	50	16	1
99010-063	63	18	1

- Tope DN20-DN40; Sin tope DN50/DN63
Stopper DN20-DN40; without stopper DN50/DN63

99020



Manguito acoplamiento PE-PE extra largo PE-PE extra large socket

ACS
EAN CODE

99020-020	20	40	10
99020-025	25	30	10
99020-032	32	28	4
99020-040	40	16	2
99020-050	50	9	1
99020-063	63	12	1

- Sin tope
Without stopper

99030



Codo 90° PE-PE PE-PE equal elbow 90°

ACS
EAN CODE

99030-020	20	60	10
99030-025	25	40	10
99030-032	32	25	5
99030-040	40	18	2
99030-050	50	11	1
99030-063	63	12	1

99050



Racor te PE PE equal tee

ACS
EAN CODE

99050-020	20	40	10
99050-025	25	30	10
99050-032	32	15	5
99050-040	40	12	2
99050-050	50	6	1
99050-063	63	8	1

99090



Racor recto macho PE-M PE-M Straight male coupling

ACS
EAN CODE

99090-02015	20 x 1/2"	130	10
99090-02515	25 x 1/2"	100	10
99090-02520	25 x 3/4"	90	10
99090-03225	32 x 1"	50	5
99090-04032	40 x 1 1/4"	36	2
99090-05040	50 x 1 1/2"	26	1
99090-06350	63 x 2"	30	1

- Rosca macho cónica
Tapered male thread

CÓDIGO CODE _____
MEDIDA SIZE _____
ENCAJADO GRANDE MASTER CARTON _____
ENCAJADO INTERMEDIO INNER CARTON _____

99110



Racor recto hembra PE-H PE-F straight female coupling

ACS
EAN CODE

99110-02015	20 x 1/2"	120	10
99110-02515	25 x 1/2"	90	10
99110-02520	25 x 3/4"	80	10
99110-03225	32 x 1"	50	5
99110-04032	40 x 1 1/4"	36	2
99110-05040	50 x 1 1/2"	25	1
99110-06350	63 x 2"	28	1

99130



Codo macho PE-M PE-M male elbow

ACS
EAN CODE

99130-02015	20 x 1/2"	90	10
99130-02520	25 x 3/4"	60	10
99130-03225	32 x 1"	35	5
99130-04032	40 x 1 1/4"	22	2
99130-05040	50 x 1 1/2"	16	1
99130-06350	63 x 2"	17	1

- Rosca macho cónica
Tapered male thread

99150



Codo hembra PE-H PE-F female elbow

ACS
EAN CODE

99150-02015	20 x 1/2"	100	10
99150-02515	25 x 1/2"	80	10
99150-02520	25 x 3/4"	70	10
99150-03225	32 x 1"	40	5
99150-04032	40 x 1 1/4"	24	2
99150-05040	50 x 1 1/2"	18	1
99150-06350	63 x 2"	20	1

99170



Racor te macho PE-M-PE PE-M-PE female tee

ACS
EAN CODE

99170-02015	20 x 1/2"	50	10
99170-02520	25 x 3/4"	30	10
99170-03225	32 x 1"	20	5

- Rosca macho cónica
Tapered male thread

99190



Racor te macho PE-H-PE PE-F-PE female tee

ACS
EAN CODE

99190-02015	20 x 1/2"	50	10
99190-02515	25 x 1/2"	40	10
99190-02520	25 x 3/4"	30	10
99190-03225	32 x 1"	20	5
99190-04032	40 x 1 1/4"	14	2
99190-05040	50 x 1 1/2"	6	1
99190-06350	63 x 2"	10	1

99120



Racor dos piezas recto PE-H PE-F straight tap connector

ACS
EAN CODE

99120-02015	20 x 1/2"	100	10
99120-02020	20 x 3/4"	90	10
99120-02520	25 x 3/4"	60	10
99120-03225	32 x 1"	45	5

CÓDIGO CODE
MEDIDA SIZE
ENCAJADO GRANDE MASTER CARTON
ENCAJADO INTERMEDIO INNER CARTON

99500



Racor codo mural PE-H

PE-F wall plated elbow

ACS

99500-02015	20 x 1/2"	60	10
99500-02515	25 x 1/2"	50	10
99500-02520	25 x 3/4"	40	10
99500-03225	32 x 1"	25	5

Recambios disponibles en página 223
Spare parts available page 223



PE - BRIDA - SERIE 89
PE - FLANGE - 89 SERIES



FICHA TÉCNICA
TECHNICAL SHEET



CÓDIGO CODE _____
MEDIDA SIZE _____
ENCAJADO GRANDE MASTER CARTON _____
ENCAJADO INTERMEDIO INNER CARTON _____

89022



Manguito acoplamiento
PE-PE PE-PE straight coupling

89022-075	75	4	1
89022-090	90	4	1
89022-110	110	2	1

- Tornillos en acero inoxidable
Stainless steel bolts
- Tope manguera
Hose stopper

89042



Racor codo 90° PE-PE PE-PE equal elbow 90°

89042-075	75	3	1
89042-090	90	1	1
89042-110	110	1	1

- Tornillos en acero inoxidable
Stainless steel bolts

89062



Racor te PE PE tee piece

89062-075	75	2	1
89062-090	90	1	1
89062-110	110	1	1

- Tornillos en acero inoxidable
Stainless steel bolts

89102



Racor recto PE-M PE-M coupling

89102-075065	75 x 2 1/2"	6	1
89102-090080	90 x 3"	5	1
89102-110100	110 x 4"	3	1

- Tornillos en acero inoxidable
Stainless steel bolts

89122



Racor recto PE-H PE-F coupling

89122-075065	75 x 2 1/2"	6	1
89122-090080	90 x 3"	5	1
89122-110100	110 x 4"	3	1

- Tornillos en acero inoxidable
Stainless steel bolts

CÓDIGO CODE _____
MEDIDA SIZE _____
ENCAJADO GRANDE MASTER CARTON _____
ENCAJADO INTERMEDIO INNER CARTON _____

89142



Racor codo PE-M PE-M Elbow 90°

89142-075065	75 x 2 1/2"	4	1
89142-090080	90 x 3"	2	1

- Tornillos en acero inoxidable
Stainless steel bolts

89162



Racor codo PE-H PE-F Elbow 90°

89162-075065	75 x 2 1/2"	4	1
89162-090080	90 x 3"	2	1
89162-110100	110 x 4"	1	1

- Tornillos en acero inoxidable
Stainless steel bolts

89202



Racor te PE-H-PE PE-F-PE tee piece

89202-075065	75 x 2 1/2" x 75	2	1
89202-090080	90 x 3" x 90	1	1
89202-110100	110 x 4" x 110	1	1

- Tornillos en acero inoxidable
Stainless steel bolts

Recambios disponibles en página 222
Spare parts available page 222



PE - A PRESIÓN - SERIE 97
PE - TO PRESSURE - 97 SERIES



FICHA TÉCNICA
TECHNICAL SHEET



CÓDIGO CODE _____
MEDIDA SIZE _____
ENCAJADO GRANDE MASTER CARTON _____
ENCAJADO INTERMEDIO INNER CARTON _____

97130		Racor te PE	PE equal tee	97130-032	32 x 32 x 32	30	5	<ul style="list-style-type: none"> • Disponible hasta agotar existencias While stocks lasts
97131		Racor te PE-H-PE	PE-F-PE female tee	97131-032	32 x 3/4" x 32	40	5	<ul style="list-style-type: none"> • Disponible hasta agotar existencias While stocks lasts
97132		Racor te PE-M-PE	PE-M-PE male tee	97132-032	32 x 1" x 32	40	5	<ul style="list-style-type: none"> • Rosca macho paralela Parallel male thread • Disponible hasta agotar existencias While stocks lasts
97270		Manguito acoplamiento PE-PE	PE-PE straight coupling	97270-032	32	75	5	<ul style="list-style-type: none"> • Disponible hasta agotar existencias While stocks lasts
97280		Racor recto macho PE-M	PE-M male coupling	97280-03225	32 x 1"	75	5	<ul style="list-style-type: none"> • Rosca macho paralela Parallel male thread • Disponible hasta agotar existencias While stocks lasts

CÓDIGO CODE
MEDIDA SIZE
ENCAJADO GRANDE MASTER CARTON
ENCAJADO INTERMEDIO INNER CARTON

97091



Codo 90° hembra PE-H

PE-F female elbow

97091-03220

32 x 3/4"

65

5

- Disponible hasta agotar existencias
While stocks lasts



PE-FE - PARA TUBO DE HIERRO - SERIE 98
PE-FE - FOR IRON PIPE - 98 SERIES



FICHA TÉCNICA
TECHNICAL SHEET



CÓDIGO CODE _____
MEDIDA SIZE _____
ENCAJADO GRANDE MASTER CARTON _____
ENCAJADO INTERMEDIO INNER CARTON _____

98010



Manguito acoplamiento Fe-Fe Fe-Fe straight coupling

EAN CODE

98010-021	21	70	10
98010-027	27	50	10
98010-034	34	30	5
98010-043	43	22	2
98010-049	49	15	1
98010-061	61	18	1

98020



Manguito hierro Fe-PE Fe-PE straight

EAN CODE

98020-02021	20 x 21	70	10
98020-02527	25 x 27	50	10
98020-03234	32 x 34	30	5
98020-04043	40 x 43	22	2
98020-05049	50 x 49	15	1
98020-06361	63 x 61	18	1

98090



Racor recto macho Fe-M Fe-M straight coupling

EAN CODE

98090-02115	21 x 1/2"	120	10
98090-02720	27 x 3/4"	80	10
98090-03425	34 x 1"	55	5
98090-04332	43 x 1 1/4"	36	2
98090-04940	49 x 1 1/2"	24	1
98090-06150	61 x 2"	30	1

- Rosca macho paralela
Parallel male thread

98110



Racor recto hembra Fe-H Fe-H female coupling

EAN CODE

98110-02115	21 x 1/2"	100	10
98110-02720	27 x 3/4"	80	10
98110-03425	34 x 1"	50	5
98110-04332	43 x 1 1/4"	36	2
98110-04940	49 x 1 1/2"	20	1
98110-06150	61 x 2"	28	1



BICONO A COMPRESIÓN NIQUELADO - SERIE 66
NICKEL PALTED COMPRESSION BICONE - 66 SERIES



FICHA TÉCNICA
TECHNICAL SHEET



CÓDIGO CODE _____
MEDIDA SIZE _____
ENCAJADO GRANDE MASTER CARTON _____
ENCAJADO INTERMEDIO INNER CARTON _____

Model	Description	Material	Code	Size	Length	Quantity
6601 	Enlace doble Straight coupling WRAS EAN CODE		6601-012	12 x 12	300	10
			6601-015	15 x 15	240	10
			6601-018	18 x 18	160	10
			6601-022	22 x 22	140	10
			6601-028	28 x 28	70	10
			6601-035	35 x 35	45	5
			6601-042	42 x 42	35	5
			6601-054	54 x 54	30	5
			6601R 	Enlace doble reducción Reducing straight coupling WRAS EAN CODE		6601-01815
6601-02215	22 x 15	150				10
6601-02218	22 x 18	130				10
6601-02822	28 x 22	100				10
6602 	Enlace hembra Female straight coupling WRAS EAN CODE		6602-01215	12 x 1/2"	300	10
			6602-01510	15 x 3/8"	220	10
			6602-01515	15 x 1/2"	220	10
			6602-01520	15 x 3/4"	180	10
			6602-01525	15 x 1"	100	10
			6602-01815	18 x 1/2"	220	10
			6602-01820	18 x 3/4"	160	10
			6602-02215	22 x 1/2"	150	10
			6602-02220	22 x 3/4"	140	10
			6602-02225	22 x 1"	100	5
			6602-02820	28 x 3/4"	80	5
			6602-02825	28 x 1"	80	5
			6602-03532	35 x 1 1/4"	40	5
			6602-04240	42 x 1 1/2"	35	5
6603 	Enlace macho Male straight coupling WRAS EAN CODE		6603-01510	15 x 3/8"	300	10
			6603-01515	15 x 1/2"	300	10
			6603-01520	15 x 3/4"	190	10
			6603-01815	18 x 1/2"	170	10
			6603-01820	18 x 3/4"	150	10
			6603-02215	22 x 1/2"	150	10
			6603-02220	22 x 3/4"	140	10
			6603-02225	22 x 1"	110	10
			6603-02820	28 x 3/4"	100	10
			6603-02825	28 x 1"	80	5
			6603-03532	35 x 1 1/4"	50	5
			6603-04240	42 x 1 1/2"	35	5

- Rosca macho paralela
Parallel male thread

CÓDIGO CODE _____
MEDIDA SIZE _____
ENCAJADO GRANDE MASTER CARTON _____
ENCAJADO INTERMEDIO INNER CARTON _____

6604



Codo 90° Elbow 90°

WRAS
EAN CODE

6604-015	15 x 15	200	10
6604-018	18 x 18	130	10
6604-022	22 x 22	90	10
6604-028	28 x 28	60	10
6604-035	35 x 35	30	5
6604-042	42 x 42	20	1
6604-054	54 x 54	28	1

6605



Codo 90° hembra Female elbow 90°

WRAS
EAN CODE

6605-01515	15 x 1/2"	170	10
6605-01520	15 x 3/4"	140	10
6605-01815	18 x 1/2"	140	10
6605-01820	18 x 3/4"	110	10
6605-02215	22 x 1/2"	110	10
6605-02220	22 x 3/4"	100	10
6605-02225	22 x 1"	60	10
6605-02825	28 x 1"	60	10

6606



Codo 90° macho Male elbow 90°

WRAS
EAN CODE

6606-01515	15 x 1/2"	200	10
6606-01520	15 x 3/4"	160	10
6606-01815	18 x 1/2"	160	10
6606-01820	18 x 3/4"	130	10
6606-02215	22 x 1/2"	120	10
6606-02220	22 x 3/4"	110	10
6606-02225	22 x 1"	70	10
6606-02825	28 x 1"	60	5

- Rosca macho paralela
Parallel male thread

6607



Tapón Cap

WRAS
EAN CODE

6607-015	15	400	10
6607-018	18	350	10
6607-022	22	230	10

6608



Te igual Equal tee

WRAS
EAN CODE

6608-015	15 x 15 x 15	120	10
6608-018	18 x 18 x 18	80	10
6608-022	22 x 22 x 22	60	10
6608-028	28 x 28 x 28	35	5
6608-035	35 x 35 x 35	20	5
6608-042	42 x 42 x 42	15	1
6608-054	54 x 54 x 54	18	1

CÓDIGO CODE _____
MEDIDA SIZE _____
ENCAJADO GRANDE MASTER CARTON _____
ENCAJADO INTERMEDIO INNER CARTON _____

6609 	Te reducida WRAS EAN CODE	Reducing tee	6609-0152215	15 x 22 x 15	80	10
			6609-0181518	18 x 15 x 18	80	10
			6609-0181815	18 x 18 x 15	80	10
			6609-0221515	22 x 15 x 15	90	10
			6609-0221522	22 x 15 x 22	70	10
			6609-0221822	22 x 18 x 22	70	10
			6609-0222215	22 x 22 x 15	70	10
			6609-0282222	28 x 22 x 22	50	10
			6609-0282815	28 x 28 x 15	40	10
			6609-0282822	28 x 28 x 22	30	10
6610 	Te hembra WRAS EAN CODE	Female tee	6610-0151515	15 x 1/2" x 15	120	10
			6610-0181518	18 x 1/2" x 18	100	10
			6610-0182018	18 x 3/4" x 18	80	10
			6610-0221522	22 x 1/2" x 22	80	10
			6610-0222022	22 x 3/4" x 22	60	10
			6610-0282028	28 x 3/4" x 28	40	5
			6610-0282528	28 x 1" x 28	35	5
			6611 	Codo placa WRAS EAN CODE	Wall plated elbow	6611-01515
6611-01815	18 x 1/2"	100				10
6611-01820	18 x 3/4"	70				10
6611-02215	22 x 1/2"	60				10
6611-02220	22 x 3/4"	50				10
6612 	Curva puente WRAS EAN CODE	Crossover	6612-015	15 x 15	100	10
			6612-018	18 x 18	60	10
			6612-022	22 x 22	40	5

Recambios disponibles en página 223
Spare parts available page 223



BICONO A COMPRESIÓN - SERIE 67
COMPRESSION BICONE - 67 SERIES

FICHA TÉCNICA
TECHNICAL SHEET



CÓDIGO CODE _____
MEDIDA SIZE _____
ENCAJADO GRANDE MASTER CARTON _____
ENCAJADO INTERMEDIO INNER CARTON _____

6701

NEW



Enlace doble Straight coupling

WRAS
EAN CODE

6701-008	8 x 8	550	25
6701-010	10 x 10	450	25
6701-012	12 x 12	300	10
6701-014	14 x 14	250	10
6701-015	15 x 15	240	10
6701-016	16 x 16	200	10
6701-018	18 x 18	160	10
6701-022	22 x 22	140	10
6701-028	28 x 28	70	10
6701-035	35 x 35	45	5
6701-042	42 x 42	35	5
6701-054	54 x 54	30	5

6701R

NEW



Enlace doble reducción Reducing straight coupling

WRAS
EAN CODE

6701-01008	10 x 8	600	25
6701-01210	12 x 10	300	10
6701-01508	15 x 8	270	10
6701-01510	15 x 10	250	10
6701-01512	15 x 12	220	10
6701-01815	18 x 15	180	10
6701-02215	22 x 15	150	10
6701-02822	28 x 22	100	10

6702

NEW



Enlace hembra Female straight coupling

WRAS
EAN CODE

6702-00810	8 x 3/8"	500	25
6702-01010	10 x 3/8"	400	25
6702-01015	10 x 1/2"	300	10
6702-01210	12 x 3/8"	300	10
6702-01215	12 x 1/2"	300	10
6702-01415	14 x 1/2"	220	10
6702-01510	15 x 3/8"	220	10
6702-01515	15 x 1/2"	220	10
6702-01520	15 x 3/4"	180	10
6702-01525	15 x 1"	100	10
6702-01615	16 x 1/2"	200	10
6702-01620	16 x 3/4"	160	10
670201815	18 x 1/2"	220	10
6702-02215	22 x 1/2"	150	10
6702-02220	22 x 3/4"	140	10
6702-02225	22 x 1"	100	5
6702-02820	28 x 3/4"	80	5
6702-02825	28 x 1"	80	5
6702-03532	35 x 1 1/4"	40	5
6702-04240	42 x 1 1/2"	35	5
6702-05450	54 x 2"	20	5

CÓDIGO CODE _____
MEDIDA SIZE _____
ENCAJADO GRANDE MASTER CARTON _____
ENCAJADO INTERMEDIO INNER CARTON _____

6703

NEW



Enlace macho

Male straight coupling

WRAS
EAN CODE

6703-00806F	8 x 1/8"	500	25
6703-01210F	12 x 3/8"	450	10
6703-01215F	12 x 1/2"	400	10
6703-01410F	14 x 3/8"	300	10
6703-01415F	14 x 1/2"	300	10
6703-01520F	15 x 3/4"	190	10
6703-01615F	16 x 1/2"	180	10
6703-01815F	18 x 1/2"	170	10
6703-01820F	18 x 3/4"	150	10
6703-02820F	28 x 3/4"	100	10
6703-03532F	35 x 1 1/4"	50	5
6703-04240F	42 x 1 1/2"	35	5

- Rosca macho paralela
Parallel male thread

6704

NEW



Codo 90°

Elbow 90°

WRAS
EAN CODE

6704-008	8 x 8	400	25
6704-010	10 x 10	350	25
6704-012	12 x 12	270	10
6704-014	14 x 14	220	10
6704-015	15 x 15	200	10
6704-016	16 x 16	150	10
6704-018	18 x 18	130	10
6704-022	22 x 22	90	10
6704-028	28 x 28	60	10
6704-035	35 x 35	30	5
6704-042	42 x 42	20	1
6704-054	54 x 54	28	1

6705

NEW



Codo 90° hembra

Female elbow 90°

WRAS
EAN CODE

6705-01015	10 x 1/2"	300	10
6705-01215	12 x 1/2"	300	10
6705-01515	15 x 1/2"	170	10
6705-01520	15 x 3/4"	140	10
6705-01815	18 x 1/2"	140	10
6705-02215	22 x 1/2"	110	10
6705-02220	22 x 3/4"	100	10
6705-02225	22 x 1"	60	10
6705-02825	28 x 1"	60	10

6706

NEW



Codo 90° macho



Male elbow 90°

WRAS
EAN CODE



6706-01015	10 x 1/2"	300	10
6706-01215	12 x 1/2"	300	10
6706-01415	14 x 1/2"	200	10
6706-01515	15 x 1/2"	200	10
6706-01520	15 x 3/4"	160	10
6706-01615	16 x 1/2"	160	10
6706-01815	18 x 1/2"	160	10
6706-02215	22 x 1/2"	120	10
6706-02220	22 x 3/4"	110	10
6706-02225	22 x 1"	70	10
6706-02825	28 x 1"	60	5

- Rosca macho paralela
Parallel male thread

CÓDIGO CODE _____
MEDIDA SIZE _____
ENCAJADO GRANDE MASTER CARTON _____
ENCAJADO INTERMEDIO INNER CARTON _____

6707 		Tapón Cap WRAS EAN CODE	6707-008	8	750	50
			6707-010	10	700	50
			6707-012	12	650	25
			6707-015	15	400	10
			6707-022	22	230	10
			6707-028	28	130	10

6708 		Te igual Equal tee WRAS EAN CODE	6708-010	10 x 10 x 10	250	25
			6708-012	12 x 12 x 12	200	25
			6708-014	14 x 14 x 14	120	10
			6708-015	15 x 15 x 15	120	10
			6708-016	16 x 16 x 16	100	10
			6708-018	18 x 18 x 18	80	10
			6708-022	22 x 22 x 22	60	10
			6708-028	28 x 28 x 28	35	5
			6708-035	35 x 35 x 35	20	5
			6708-042	42 x 42 x 42	15	1
			6708-054	54 x 54 x 54	18	1

6709 		Te reducida Reducingl tee WRAS EAN CODE	6709-0152215	15 x 22 x 15	80	10
			6709-0181518	18 x 15 x 18	80	10
			6709-0181815	18 x 18 x 15	80	10
			6709-0221515	22 x 15 x 15	90	10
			6709-0221522	22 x 15 x 22	70	10
			6709-0222215	22 x 22 x 15	70	10
			6709-0282222	28 x 22 x 22	50	10
			6709-0282815	28 x 28 x 15	40	10
			6709-0282822	28 x 28 x 22	30	10

6710 		Te hembra Femalel tee WRAS EAN CODE	6710-0151515	15 x 1/2" x 15	120	10
			6710-0182018	18 x 3/4" x 18	80	10
			6710-0221522	22 x 1/2" x 22	80	10
			6710-0222022	22 x 3/4" x 22	60	10

6711 		Codo placa Wall plated elbow WRAS EAN CODE	6711-01515	15 x 1/2"	120	10
			6711-02215	22 x 1/2"	60	10
			6711-02220	22 x 3/4"	50	10

CÓDIGO CODE _____
MEDIDA SIZE _____
ENCAJADO GRANDE MASTER CARTON _____
ENCAJADO INTERMEDIO INNER CARTON _____

6712

NEW



Curva puente

Crossover

WRAS

EAN CODE

6712-015	15 x 15	100	10
6712-022	22 x 22	40	5

6713

NEW



Codo 90° hembra tuerca
móvil

Female elbow 90° with
loose nut

WRAS

EAN CODE

6713-01515	15 x 1/2"	150	10
6713-02220	22 x 3/4"	80	10

Recambios disponibles en página 223
Spare parts available page 223



MT GARDEN
MT GARDEN

CÓDIGO CODE _____
 MEDIDA SIZE _____
 ENCAJADO GRANDE MASTER CARTON _____
 ENCAJADO INTERMEDIO INNER CARTON _____

4131G



Lanza de riego regulable

Quick connector adjustable
nozzle

EAN CODE

4131-000G 100mm. 60 1



FICHA TÉCNICA
TECHNICAL SHEET

4134G

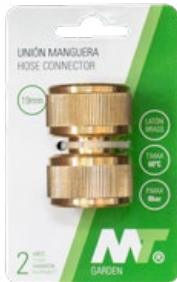

Unión manguera manguera

Hose to hose connector

EAN CODE

4134-015G 15mm. 70 1
 4134-019G 19mm. 40 1



FICHA TÉCNICA
TECHNICAL SHEET

4133G



Enchufe rápido

Quick connector

EAN CODE

4133-015G 15mm. 70 1
 4133-019G 19mm. 50 1



FICHA TÉCNICA
TECHNICAL SHEET

41332G



Enchufe rápido con stop

Quick connector with stop

EAN CODE

41332-015G 15mm. 70 1
 41332-019G 19mm. 50 1



FICHA TÉCNICA
TECHNICAL SHEET

CÓDIGO CODE _____
MEDIDA SIZE _____
ENCAJADO GRANDE MASTER CARTON _____
ENCAJADO INTERMEDIO INNER CARTON _____

4132G



Racor hembra con enchufe rápido Female with quick connector

EAN CODE

4132-015G	1/2"	70	1
4132-020G	3/4"	70	1
4132-025G	1"	60	1



FICHA TÉCNICA
TECHNICAL SHEET

4135G



Racor macho con enchufe rápido Male with quick connector

EAN CODE

4135-015G	1/2"	70	1
4135-020G	3/4"	70	1



FICHA TÉCNICA
TECHNICAL SHEET

41302G



Derivación dos salidas Two way tap outlet

EAN CODE

41302-02020G	3/4" x 3/4" x 3/4"	10	1
--------------	--------------------	----	---



FICHA TÉCNICA
TECHNICAL SHEET

41303G



Derivación tres salidas Three way tap outlet

EAN CODE

41303-02020G	3/4" x 3/4" x 3/4" x 3/4"	8	1
--------------	---------------------------	---	---



FICHA TÉCNICA
TECHNICAL SHEET

Ver página 29 para grifos compatibles con nuestra gama MT Garden
See page 29 to bibcocks compatible with our MT Garden range

2

ACCESORIOS Y BRIDAS

FITTINGS AND FLANGES



2

ACCESORIOS Y BRIDAS

FITTINGS AND FLANGES

2.2

ACERO INOXIDABLE

STAINLESS STEEL

Aplicaciones

Industria química, industrias petroquímicas y gas natural, industria alimentaria, entornos industriales de medios corrosivos y temperaturas extremas. Conducción de fluidos, calderas, condensadores, intercambio de calor, reactores, etc.

Applications

Chemical, petrochemical and natural gas, food processing, corrosive industrial environments and extreme temperatures. Fluid handling, boilers, condensers, heat exchangers, reactors, etc.

Rango de temperatura °C
Temperature range °C

 -20°
300°



ACCESORIOS Y BRIDAS DE ACERO INOXIDABLE	
STAINLESS STEEL FITTINGS AND FLANGES	
Sistema MT Press MT Press system	122
Abarcones U-bolts	131
Roscados Threaded	133
Soldados Soldered	140
Bridas Flanges	146

Producto

Accesorio de acero inoxidable

Product

Stainless steel fitting

Normas de fabricación

Dimensiones según Norma ISO 4144

Manufacturing standards

Dimensions according ISO 4144





SISTEMA MTPRESS MTPRESS SYSTEM



FICHA TÉCNICA
TECHNICAL SHEET



01040

Curva 45° M-H

F-M 45° elbow

DVGW

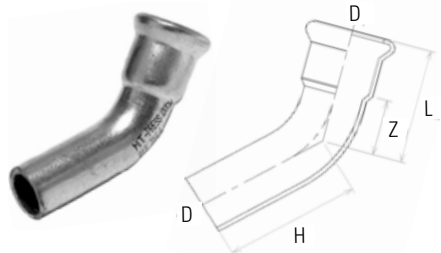

CÓDIGO CODE	MEDIDA SIZE	L	H	Z		
01040-015	15	32	43	12	160	10
01040-018	18	34	48	14	140	10
01040-022	22	38	52	18	90	10
01040-028	28	42	56	22	50	10
01040-035	35	52	62	28	50	5
01040-042	42	60	72	30	30	5
01040-054	54	72	84	37	20	5
01040-076	76	102	120	49	8	1
01040-088	88	115	134	55	4	1
01040-108	108	142	163	67	2	1

01041

Curva 45° H-H

F-F 45° elbow

DVGW

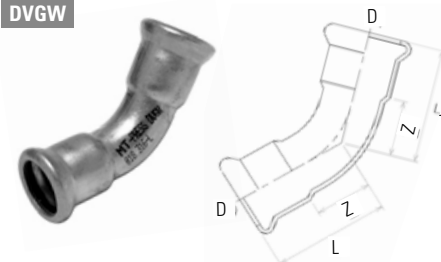

CÓDIGO CODE	MEDIDA SIZE	L	Z		
01041-015	15	32	12	160	10
01041-018	18	34	14	140	10
01041-022	22	38	18	100	10
01041-028	28	42	22	50	10
01041-035	35	52	28	60	5
01041-042	42	60	30	40	5
01041-054	54	72	37	20	5
01041-076	76	102	49	8	1
01041-088	88	115	55	4	1
01041-108	108	142	67	2	1

01001

Curva 90° M-H

M-F 45° elbow

DVGW

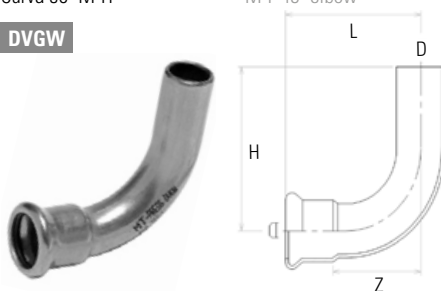

CÓDIGO CODE	MEDIDA SIZE	L	H	Z		
01001-015	15	43	49	23	140	10
01001-018	18	46	52	26	110	10
01001-022	22	53	57	32	70	10
01001-028	28	64	71	41	40	10
01001-035	35	78	90	52	50	5
01001-042	42	90	102	60	30	5
01001-054	54	110	122	75	15	5
01001-076	76	157	173	104	4	1
01001-088	88	178	199	118	3	1
01001-108	108	215	235	140	1	1

01002

Curva 90° H-H

F-F 45° elbow

DVGW

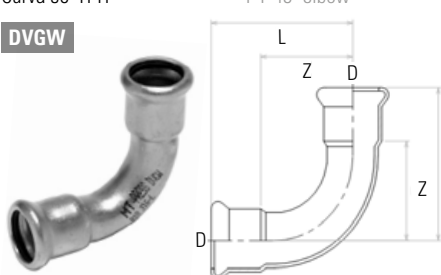

CÓDIGO CODE	MEDIDA SIZE	L	Z		
01002-015	15	43	23	140	10
01002-018	18	46	26	100	10
01002-022	22	53	32	80	10
01002-028	28	64	41	40	10
01002-035	35	78	52	50	5
01002-042	42	90	60	30	5
01002-054	54	110	75	15	5
01002-076	76	157	104	4	1
01002-088	88	178	118	3	1
01002-108	108	215	140	1	1

01003

Curva 90° M

DVGW



M 90° elbow

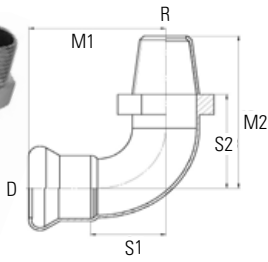

CÓDIGO CODE	MEDIDA SIZE	R	D	S1	S2	M1	M2	📦	📦
01003-03525	35 x 1"	1"	35	61	63	87	89	15	1
01003-03532	35 x 1 1/4"	1 1/4"	35	61	63	87	89	10	1
01003-04232	42 x 1 1/4"	1 1/4"	42	83	85	113	115	6	1

01090

Curva 90° H

DVGW



F 90° elbow

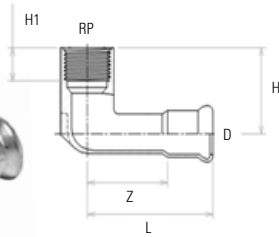

CÓDIGO CODE	MEDIDA SIZE	RP	H	H1	L	Z	📦	📦
01090-01515	15 x 1/2"	1/2"	37	12	55	35	100	10
01090-01520	15 x 3/4"	3/4"	37	14	58	37	100	10
01090-01815	18 x 1/2"	1/2"	39	12	58	37	100	10
01090-01820	18 x 3/4"	3/4"	39	14	60	37	50	10
01090-02220	22 x 3/4"	3/4"	46	14	60	39	50	10
01090-02825	28 x 1"	1"	54	19	68	45	30	10
01090-03532	35 x 1 1/4"	1 1/4"	63	22	76	50	35	5

01092

Curva 90° M

DVGW



M 90° elbow

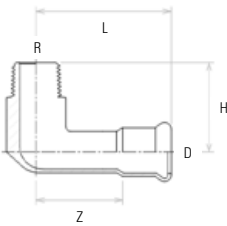

CÓDIGO CODE	MEDIDA SIZE	R	L	H	Z	📦	📦
01092-01515	15 x 1/2"	1/2"	55	37	35	100	10
01092-01815	18 x 1/2"	1/2"	57	39	37	100	10
01092-01820	18 x 3/4"	3/4"	57	42	37	100	10
01092-02220	22 x 3/4"	3/4"	60	46	39	60	10
01092-02825	28 x 1"	1"	68	54	45	40	10
01092-03532	35 x 1 1/4"	1 1/4"	76	63	50	35	5
01092-04240	42 x 1 1/2"	1 1/2"	83	67	53	30	5
01092-05450	54 x 2"	2"	94	77	59	20	5

01131

Te hembra roscada

DVGW



Branch tee female outlet

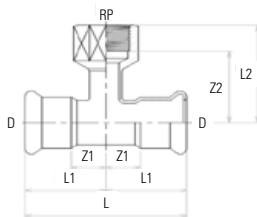

CÓDIGO CODE	MEDIDA SIZE	RP	L	L1	L2	Z1	Z2	📦	📦
01131-01515	15 x 1/2" x 15	1/2"	66	33	38	13	24	100	10
01131-01815	18 x 1/2" x 18	1/2"	68	34	41	14	27	80	10
01131-01820	18 x 3/4" x 18	3/4"	68	34	43	14	28	70	10
01131-02215	22 x 1/2" x 22	1/2"	74	37	42	16	28	60	10
01131-02220	22 x 3/4" x 22	3/4"	74	37	45	16	30	60	10
01131-02815	28 x 1/2" x 28	1/2"	84	42	45	19	31	40	10
01131-02820	28 x 3/4" x 28	3/4"	84	42	47	19	32	30	10
01131-02825	28 x 1" x 28	1"	84	42	52	19	36	30	10
01131-03515	35 x 1/2" x 35	1/2"	100	50	49	24	34	40	5
01131-03520	35 x 3/4" x 35	3/4"	100	50	51	24	36	40	5
01131-03525	35 x 1" x 35	1"	100	50	56	24	40	40	5
01131-03532	35 x 1 1/4" x 35	1 1/4"	100	50	57	24	37	40	5
01131-04215	42 x 1/2" x 42	1/2"	114	57	53	27	39	30	5
01131-04220	42 x 3/4" x 42	3/4"	114	57	54	27	39	30	5
01131-04225	42 x 1" x 42	1"	114	57	59	27	43	30	5
01131-04240	42 x 1 1/2" x 42	1 1/2"	114	57	60	27	40	30	5
01131-05415	54 x 1/2" x 54	1/2"	138	69	58	34	44	15	5
01131-05420	54 x 3/4" x 54	3/4"	138	69	60	34	45	15	5
01131-05425	54 x 1" x 54	1"	138	69	65	34	49	15	5
01131-05450	54 x 2" x 54	2"	138	69	78	34	54	15	5
01131-07620	76 x 3/4" x 76	3/4"	230	115	70	62	55	6	1
01131-07650	76 x 2" x 76	2"	230	115	88	62	64	4	1
01131-08820	88 x 3/4" x 88	3/4"	260	130	78	70	62	2	1
01131-08850	88 x 2" x 88	2"	260	130	96	70	71	2	1
01131-10820	108 x 3/4" x 108	3/4"	310	155	86	80	71	2	1
01131-10850	108 x 2" x 108	2"	310	155	104	80	79	2	1

01130

Te igual

DVGW



Equal tee

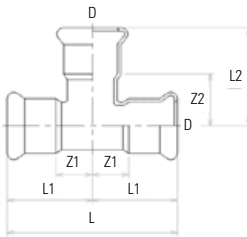

CÓDIGO CODE	MEDIDA SIZE	L	L1	L2	Z1	Z2		
01130-015	15	66	33	39	13	19	100	10
01130-018	18	68	34	40	14	20	80	10
01130-022	22	74	37	44	16	23	60	10
01130-028	28	84	42	52	19	29	30	10
01130-035	35	100	53	57	27	30	30	5
01130-042	42	114	57	65	27	34	20	5
01130-054	54	138	69	77	34	42	15	5
01130-076	76	230	115	110	62	58	4	1
01130-088	88	260	130	128	70	68	2	1
01130-108	108	310	150	153	78	81	1	1

01132

Te reducida

DVGW



Reducing tee

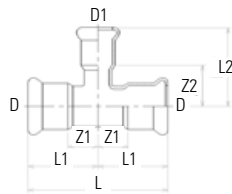

CÓDIGO CODE	MEDIDA SIZE	L	L1	L2	Z1	Z2		
01132-01815	18 x 15 x 18	68	34	40	14	20	80	10
01132-02215	22 x 15 x 22	74	37	43	16	22	70	10
01132-02218	22 x 18 x 22	74	37	43	16	22	60	10
01132-02228	22 x 28 x 22	74	37	49	16	24	60	10
01132-02815	28 x 15 x 28	84	42	45	19	25	40	10
01132-02818	28 x 18 x 28	84	42	46	19	25	40	10
01132-02822	28 x 22 x 28	84	42	47	19	26	40	10
01132-03515	35 x 15 x 35	100	50	49	24	29	40	5
01132-03518	35 x 18 x 35	100	50	50	24	29	40	5
01132-03522	35 x 22 x 35	100	50	51	24	30	40	5
01132-03528	35 x 28 x 35	100	50	56	24	33	40	5
01132-04215	42 x 15 x 42	114	57	53	27	33	30	5
01132-04218	42 x 18 x 42	114	57	53	27	33	30	5
01132-04222	42 x 22 x 42	114	57	55	27	34	30	5
01132-04228	42 x 28 x 42	114	57	60	27	37	30	5
01132-04235	42 x 35 x 42	114	57	61	27	34	25	5
01132-05415	54 x 15 x 54	138	69	59	34	39	15	5
01132-05418	54 x 18 x 54	138	69	59	34	39	15	5
01132-05422	54 x 22 x 54	138	69	61	34	40	15	5
01132-05428	54 x 28 x 54	138	69	66	34	43	15	5
01132-05435	54 x 35 x 54	138	69	67	34	40	15	5
01132-05442	54 x 42 x 54	138	69	71	34	38	15	5
01132-07622	76 x 22 x 76	230	115	71	62	50	8	1
01132-07628	76 x 28 x 76	230	115	76	62	53	6	1
01132-07635	76 x 35 x 76	230	115	77	62	50	6	1
01132-07642	76 x 42 x 76	230	115	81	62	48	6	1
01132-07654	76 x 54 x 76	230	115	87	62	53	6	1
01132-08822	88 x 22 x 88	260	130	76	70	58	2	1
01132-08828	88 x 28 x 88	260	130	83	70	61	2	1
01132-08835	88 x 35 x 88	260	130	87	70	58	2	1
01132-08842	88 x 42 x 88	260	130	87	70	58	2	1
01132-08854	88 x 54 x 88	260	130	94	70	63	2	1
01132-08876	88 x 76 x 88	260	130	118	70	69	2	1
01132-10822	108 x 22 x 108	310	152	87	77	73	2	1
01132-10828	108 x 28 x 108	310	155	93	80	76	2	1
01132-10835	108 x 35 x 108	310	155	93	80	69	2	1
01132-10842	108 x 42 x 108	310	155	97	80	67	2	1
01132-10854	108 x 54 x 108	310	155	103	80	71	2	1
01132-10876	108 x 76 x 108	310	155	127	80	77	2	1
01132-10888	108 x 88 x 108	310	155	137	80	80	1	1

01246

Reducción M-H

DVGW



M-F reducing

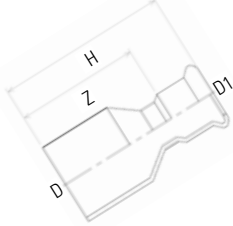

CÓDIGO CODE	MEDIDA SIZE	H	Z	📦	📦
01246-01815	18 x 15	62	42	160	10
01246-02215	22 x 15	62	42	150	10
01246-02218	22 x 18	61	40	130	10
01246-02815	28 x 15	65	43	120	10
01246-02818	28 x 18	67	47	120	10
01246-02822	28 x 22	66	45	100	10
01246-03515	35 x 15	75	55	150	5
01246-03518	35 x 18	78	58	150	5
01246-03522	35 x 22	68	47	150	5
01246-03528	35 x 28	76	53	120	5
01246-04215	42 x 15	84	60	100	5
01246-04218	42 x 18	80	60	80	5
01246-04222	42 x 22	84	63	80	5
01246-04228	42 x 28	77	59	80	5
01246-04235	42 x 35	81	54	80	5
01246-05415	54 x 15	96	76	50	5
01246-05418	54 x 18	92	72	50	5
01246-05422	54 x 22	96	75	50	5
01246-05428	54 x 28	98	75	50	5
01246-05435	54 x 35	96	70	50	5
01246-05442	54 x 42	102	72	40	5
01246-07642	76 x 42	142	112	24	1
01246-07654	76 x 54	145	110	24	1
01246-08854	88 x 54	147	112	12	1
01246-08876	88 x 76	161	108	8	1
01246-10854	108 x 54	162	127	7	1
01246-10876	108 x 76	176	123	7	1
01246-10888	108 x 88	203	143	4	1

01270

Manguito H-H

DVGW



F-F coupling

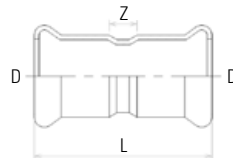

CÓDIGO CODE	MEDIDA SIZE	L	Z	📦	📦
01270-015	15	48	8	160	10
01270-018	18	48	8	140	10
01270-022	22	50	8	120	10
01270-028	28	54	8	80	10
01270-035	35	62	10	100	5
01270-042	42	71	11	60	5
01270-054	54	83	13	30	5
01270-076	76	141	35	8	1
01270-088	88	162	42	7	1
01270-108	108	194	44	3	1

01290

Tapón

DVGW



Cap

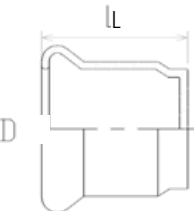

CÓDIGO CODE	MEDIDA SIZE	L	📦	📦
01290-015	15	34	200	10
01290-018	18	35	180	10
01290-022	22	39	150	10
01290-028	28	48	100	10
01290-035	35	51	120	5
01290-042	42	59	70	5
01290-054	54	67	50	5
01290-076	76	94	20	1
01290-088	88	103	16	1
01290-108	108	124	6	1

01340

Unión H

DVGW



F union

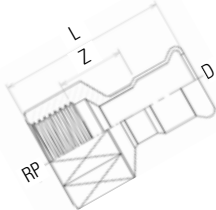

CÓDIGO CODE	MEDIDA SIZE (DxRp)	L	Z	📦	📦
01340-01510	15 x 3/8"	53	33	160	10
01340-01515	15 x 1/2"	55	20	160	10
01340-01520	15 x 3/4"	59	21	140	10
01340-01815	18 x 1/2"	60	24	120	10
01340-01820	18 x 3/4"	60	26	120	10
01340-02215	22 x 1/2"	58	24	100	10
01340-02220	22 x 3/4"	61	25	100	10
01340-02225	22 x 1"	66	26	100	10
01340-02820	28 x 3/4"	64	26	60	10
01340-02825	28 x 1"	70	28	60	10
01340-02832	28 x 1 1/4"	71	26	60	10
01340-03525	35 x 1"	66	20	80	5
01340-03532	35 x 1 1/4"	72	25	80	5
01340-03540	35 x 1 1/2"	72	25	60	5
01340-04232	42 x 1 1/4"	70	20	50	5
01340-04240	42 x 1 1/2"	76	21	40	5
01340-05440	54 x 1 1/2"	76	21	30	5
01340-05450	54 x 2"	94	34	30	5
01340-07665	76 x 2 1/2"	117	38	8	1

01341

Unión M

DVGW



M union

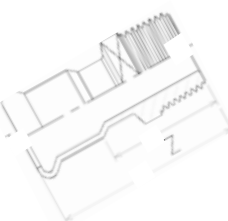

CÓDIGO CODE	MEDIDA SIZE (DxRp)	L	Z	📦	📦
01341-01510	15 x 3/8"	53	33	160	10
01341-01515	15 x 1/2"	54	35	160	10
01341-01520	15 x 3/4"	58	37	160	10
01341-01815	18 x 1/2"	55	35	120	10
01341-01820	18 x 3/4"	59	39	120	10
01341-02215	22 x 1/2"	56	35	100	10
01341-02220	22 x 3/4"	60	39	100	10
01341-02225	22 x 1"	63	42	80	10
01341-02820	28 x 3/4"	66	43	60	10
01341-02825	28 x 1"	68	45	60	10
01341-02832	28 x 1 1/4"	70	47	50	10
01341-03525	35 x 1"	69	43	100	5
01341-03532	35 x 1 1/4"	71	44	100	5
01341-03540	35 x 1 1/2"	71	44	100	5
01341-04232	42 x 1 1/4"	75	46	50	5
01341-04240	42 x 1 1/2"	75	46	50	5
01341-05440	54 x 1 1/2"	84	49	30	5
01341-05450	54 x 2"	90	55	30	5
01341-07665	76 x 2 1/2"	120	62	8	1
01341-08880	88 x 3"	133	70	7	1
01341-08100	108 x 4"	158	82	3	1

01359

Racor dos piezas H

DVGW



F tap connector two pieces

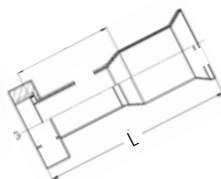

CÓDIGO CODE	MEDIDA SIZE (DxG)	L	Z	📦	📦
01359-01515	15 x 1/2"	50	18	200	10
01359-01520	15 x 3/4"	49	18	180	10
01359-01815	18 x 1/2"	51	20	180	10
01359-01820	18 x 3/4"	51	20	160	10
01359-02220	22 x 3/4"	52	21	120	10
01359-02225	22 x 1"	54	21	120	10
01359-02825	28 x 1"	59	24	80	10
01359-02832	28 x 1 1/4"	61	26	60	10
01359-03532	35 x 1 1/4"	63	25	80	5
01359-03540	35 x 1 1/2"	63	25	80	5
01359-04240	42 x 1 1/2"	68	25	70	5
01359-04250	42 x 2"	68	25	60	5
01359-05450	54 x 2"	74	24	30	5
01359-05465	54 x 2 1/2"	75	24	30	5

- Junta plana incluida
Flat joint included

01321

Brida adaptador

Adaptor flange

DVGW

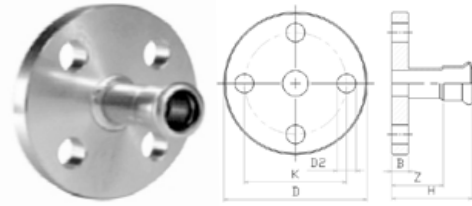

CÓDIGO CODE	MEDIDA SIZE	D	K	B	H	Z	D2	N		
01321-015	15	95	65	11	43	23	14	4	20	1
01321-018	18	95	65	11	44	23	14	4	20	1
01321-022	22	105	75	12	48	26	14	4	12	1
01321-028	28	115	85	14	55	31	14	4	12	1
01321-035	35	140	100	15	63	34	18	4	10	1
01321-042	42	150	110	16	72	40	18	4	8	1
01321-054	54	165	125	18	84	49	18	4	6	1
01321-076	76	185	145	18	133	76	18	4	3	1
01321-088	88	200	160	20	149	88	18	8	3	1
01321-108	108	220	180	20	174	98	18	8	2	1

01360

Racor tres piezas

Tap connector three pieces

DVGW

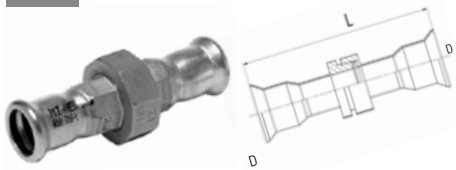

CÓDIGO CODE	MEDIDA SIZE (D)	L		
01360-015	15	89	100	10
01360-018	18	92	80	10
01360-022	22	99	50	10
01360-028	28	112	30	10
01360-035	35	119	40	5
01360-042	42	128	30	5
01360-054	54	141	15	5

01440

Conector H

F connector

DVGW

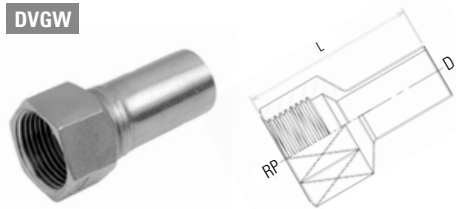

CÓDIGO CODE	MEDIDA SIZE (DXRp)	L		
01440-01515	15 x 1/2"	55	180	10
01440-01815	18 x 1/2"	60	160	10
01440-01820	18 x 3/4"	62	140	10
01440-02215	22 x 1/2"	59	100	10
01440-02220	22 x 3/4"	62	100	10
01440-02820	28 x 3/4"	64	60	10
01440-02825	28 x 1"	70	60	10

01441

Conector M

M connector

DVGW

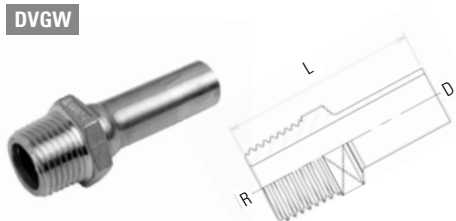

CÓDIGO CODE	MEDIDA SIZE (DXR)	L		
01441-01515	15 x 1/2"	53	180	10
01441-01815	18 x 1/2"	57	160	10
01441-01820	18 x 3/4"	61	140	10
01441-02215	22 x 1/2"	57	100	10
01441-02220	22 x 3/4"	61	100	10
01441-02820	28 x 3/4"	65	60	10
01441-02825	28 x 1"	68	60	10

01472

Codo placa

Wall plated elbow

DVGW

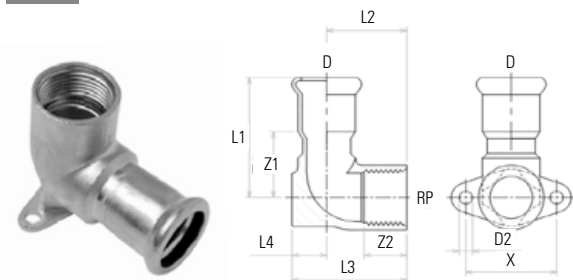

CÓDIGO CODE	MEDIDA SIZE (DXRp)	L1	L2	L3	L4	Z1	Z2	D2	X		
01472-01515	15 x 1/2"	50	30	43	13	30	15	5	34	100	10
01472-01815	18 x 1/2"	51	30	43	13	30	15	5	34	90	10
01472-02220	22 x 3/4"	55	34	51	17	34	16	6	40	60	10

COMPATIBILIDAD DIÁMETRO / MATERIALES DIAMETER / MATERIAL COMPATIBILITY

FLUIDOS FLUIDS	EPDM	FKM
ACEITES SINTÉTICOS SYNTHETIC OIL	x	✓
ACEITES VEGETALES VEGETABLE OIL	✓	✓
ÁCIDO ACÉTICO ACETIC ACID	✓	x
ÁCIDO CLORHÍDRICO HYDROCHLORIC ACID	✓	✓
ÁCIDO FÓRMICO FORMIC ACID	✓	x
ÁCIDO NÍTRICO NITRIC ACID	x	✓
ÁCIDO SULFÚRICO SULFURIC ACID	x	✓
AMONÍACO AMMONIA	✓	x
AGUA DESTILADA DISTILLED WATER	✓	✓
AGUA LÍQUIDA <100° LIQUID WATER	✓	✓
AGUA VAPOR <140° STEAM	✓	✓
AGUA VAPOR >140° STEAM	x	✓
AIRE COMPRIMIDO COMPRESSED AIR	x	✓
ARGÓN ARGON	✓	✓
DIÓXIDO DE CARBONO CARBON DIOXIDE	✓	✓
ETILENGLICOL ETILENGLICOL	✓	✓
PROPILENGLICOL PROPYLENGLICOL	✓	✓
NITRÓGENO NITROGEN	✓	✓
BENZENO BENZENE	x	✓
GASOLINA GASOLINE	x	✓
GASOIL / DIESEL / FUELOIL DIESEL	x	✓
HIDRÓXIDO SÓDICO SODIUM HYDROXIDE	✓	✓
METANOL METANOL	✓	✓
TETRACLOROETILENO TETRACHLORETHYLENE	x	✓
XILENO XYLENE	x	✓

- x Incompatible Non suitable
- ✓ Compatible Suitable

APLICACIONES APPLICATIONS

APLICACIÓN APPLICATION	TUBERÍA PIPE	JUNTA GASKET	PRESIÓN MÁX. (BAR) MAX. PRESSURE (BAR)	T (°C)
Agua potable Drinkable water	AISI-316L	EPDM	16 bar	0/+120°C
Calefacción Heating systems	AISI-304/AISI-316L	EPDM	16 bar	0/+120°C
Sistemas antiincendios Firefighting systems	AISI-304/AISI-316L	EPDM	12,5 bar	Ambiente Room temp.
Refrigeración Air cooling	AISI-304/AISI-316L	EPDM	16 bar	-20/+120°C
Solar Solar power	AISI-304/AISI-316L	FKM	6 bar	-20/+180°C
Aire Comprimido Compressed air	AISI-304/AISI-316L	EPDM/ FKM	16 bar (DN15-DN54)	Ambiente Room temp.
Nitrógeno Nitrogen (gas)	AISI-316L	EPDM	16 bar (DN15-DN54) 10 bar (DN76-DN108)	Ambiente Room temp.
Argón Argon (gas)	AISI-316L	EPDM	16 bar (DN15-DN54) 10 bar (DN76-DN108)	Ambiente Room temp.
Dióxido Carbono Carbon dioxide (gas)	AISI-304/AISI-316L	EPDM	16 bar (DN15-DN54) 10 bar (DN76-DN108)	Ambiente Room temp.
Vapor Steam	AISI-316L	FKM	1 bar	Max. +120°C
Vacío Vacuum	AISI-304/AISI-316L	EPDM	-0,8 bar	Ambiente Room temp.

- Las aplicaciones y los valores descritos en esta tabla son orientativos y basadas en las instalaciones ya realizadas y supervisadas por MT Valves and Fittings y que están funcionando correctamente.
The applications and values described in this table are indicative and based on the installations already carried out and supervised by MT Valves and Fittings and that are functioning correctly.

• **Recambios** Junta EPDM/FKM disponibles en página 223
Spare parts O-ring EPDM/FKM available page 223

015004
AISI 304

 Tubo soldado en acero
inoxidable 304

 Welded Stainless steel
pipe 304

DVGW

CÓDIGO CODE	MEDIDA SIZE	METROS METERS
015004-01506	15 x 0.6	5
015004-01510	15 x 1.0	6
015004-01807	18 x 0.7	5
015004-01810	18 x 1.0	6
015004-02207	22 x 0.7	5
015004-02212	22 x 1.2	6
015004-02808	28 x 0.8	5
015004-02812	28 x 1.2	6
015004-03510	35 x 1.0	5
015004-03515	35 x 1.5	6
015004-04212	42 x 1.2	5
015004-04215	42 x 1.5	6
015004-05412	54 x 1.2	5
015004-05415	54 x 1.5	6
015004-07615	76.1 x 1.5	6
015004-07620	76.1 x 2.0	6
015004-08820	88.9 x 2.0	6
015004-10820	108 x 2.0	6

- Otras dimensiones bajo consulta
Other dimensions under request

015006
AISI 316L

 Tubo soldado en acero
inoxidable 316L

 Welded Stainless steel
pipe 316L

DVGW

CÓDIGO CODE	MEDIDA SIZE	METROS METERS
015006-01506	15 x 0.6	5
015006-01510	15 x 1.0	6
015006-01807	18 x 0.7	5
015006-01810	18 x 1.0	6
015006-02207	22 x 0.7	5
015006-02212	22 x 1.2	6
015006-02808	28 x 0.8	5
015006-02812	28 x 1.2	6
015006-03510	35 x 1.0	5
015006-03515	35 x 1.5	6
015006-04212	42 x 1.2	5
015006-04215	42 x 1.5	6
015006-05412	54 x 1.2	5
015006-05415	54 x 1.5	6
015006-07615	76 x 1.5	6
015006-07620	76.1 x 2.0	6
015006-08820	88.9 x 2.0	6
015006-10820	108 x 2.0	6

- Otras dimensiones bajo consulta
Other dimensions under request

DIÁMETRO EXTERIOR EXTERNAL DIAMETER	GROSOR THICKNESS		PESO POR METRO (KG) WEIGHT PER METER (KG)	
	Serie 1	Serie 2	Serie 1	Serie 2
15	0,6	1	0,22	0,35
18	0,7	1	0,3	0,43
22	0,7	1,2	0,37	0,63
28	0,8	1,2	0,55	0,81
35	1	1,5	0,85	1,26
42	1,2	1,5	1,23	1,52
54	1,2	1,5	1,59	1,97
76,1	1,5	2	2,81	3,72
88,9	2	2	4,36	4,36
108	2	2	5,31	5,31

- Tubería de acero inoxidable según las norma DVGW GW 541 y UNE-EN-10088
Stainless steel pipe according to DVGW GW 541 and UNE-EN-10088

UAP432CFM

Máquina de prensar electro hidráulica con bluetooth y pantalla oled

Electrohydraulic machine for press with bluetooth and oled screen



CÓDIGO CODE

UAP432CFM

- Se suministra con: maletín, máquina, cargador (LGL1), una batería (18V/3) y un adaptador enchufable (NG2230)
Supplied with: briefcase, machine, charger (LGL1), a battery (18V/3) and a plug-in adapter (NG2230)
- Admite mordazas desde 15 a 108
Accepts jaws from 15 to 108.

SBM

Mordaza de prensar

Pressing jaw



CÓDIGO CODE

SB15M

MEDIDA SIZE

15

SB18M

18

SB22M

22

SB28M

28

SB35M

35

- Perfil M
M profile

SSKMN

Cadena de prensado

Pressing chain



CÓDIGO CODE

SSK42MN

MEDIDA SIZE

42

SSK54MN

54

- Perfil M
M profile

SBK4254

Mordaza adaptadora

Adapter jaw



CÓDIGO CODE

SBK4254

MEDIDA SIZE

42-54

BPLP

Cadena de prensado

Pressing chain



CÓDIGO CODE

BP761LP

MEDIDA SIZE

76,1

BP889LP

88,9

BP108LP

108

- Baja presión 48Bar
Low pressure 48Bar

SBKUAP4

Mordaza adaptadora

Adapter jaw



CÓDIGO CODE

SBKUAP4

MEDIDA SIZE

76-88-108

PACK MAP 2L19

Klauke
A Textron Company

Maletín pack maquinaria press MAP2L19

Briefcase machine press pack MAP2L19



CÓDIGO CODE

PACKMAP2L19

MEDIDA SIZE

15-35 (M)

- Se suministra con: maletín, máquina, cargador, una batería y mordazas 15-18-22-28-35.
Supplied with: case, machine, charger, battery and clamps 15-18-22-28-35.



ABARCONES U-BOLTS



FICHA TÉCNICA
TECHNICAL SHEET



160101

Abarcón acero al carbono
cincado

U-bolt carbon steel
galvanized



CÓDIGO CODE	MEDIDA SIZE	📦	📦
160101-008	1/4"	600	1
160101-010	3/8"	600	1
160101-015	1/2"	600	1
160101-020	3/4"	600	1
160101-025	1"	600	1
160101-032	1 1/4"	600	1
160101-040	1 1/2"	300	1
160101-050	2"	200	1
160101-065	2 1/2"	150	1
160101-080	3"	125	1
160101-090	3 1/2"	125	1
160101-100	4"	100	1
160101-125	5"	125	1
160101-150	6"	50	1
160101-200	8"	50	1

160204 AISI 304 (A2)

Abarcón acero inoxidable

U-bolt stainless steel



CÓDIGO CODE	MEDIDA SIZE	📦	📦
160204-008	1/4"	100	1
160204-010	3/8"	100	1
160204-015	1/2"	100	1
160204-020	3/4"	100	1
160204-025	1"	100	1
160204-032	1 1/4"	100	1
160204-040	1 1/2"	100	1
160204-050	2"	100	1
160204-065	2 1/2"	50	1
160204-080	3"	50	1
160204-090	3 1/2"	50	1
160204-100	4"	50	1
160204-125	5"	50	1
160204-150	6"	25	1
160204-200	8"	25	1

160306 AISI 316 (A4)

Abarcón acero inoxidable

U-bolt stainless steel



CÓDIGO CODE	MEDIDA SIZE	📦	📦
160306-008	1/4"	100	1
160306-010	3/8"	100	1
160306-015	1/2"	100	1
160306-020	3/4"	100	1
160306-025	1"	100	1
160306-032	1 1/4"	100	1
160306-040	1 1/2"	100	1
160306-050	2"	100	1
160306-065	2 1/2"	50	1
160306-080	3"	50	1
160306-090	3 1/2"	50	1
160306-100	4"	50	1
160306-125	5"	50	1
160306-150	6"	25	1
160306-200	8"	25	1

FICHA TÉCNICA PARA ABARCÓN TECHNICAL DATA SHEET FOR U-BOLT

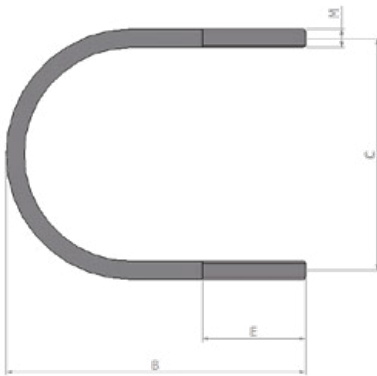

MEDIDA SIZE	B	C	E	M
1/4"	32	20	14	M6
3/8"	37	23,5	15	M6
1/2"	42	28	17	M6
3/4"	50	34	19	M6
1"	62	41	24	M6
1 1/4"	71	49	24	M6
1 1/2"	80	57	26	M8
2"	91	70	26	M8
2 1/2"	117,5	85	35	M10
3"	130,5	101	35	M10
3 1/2"	143	114	35	M10
4"	155	127	35	M10
5"	186	154	40	M10
6"	213	181	40	M10
8"	264	232	40	M10

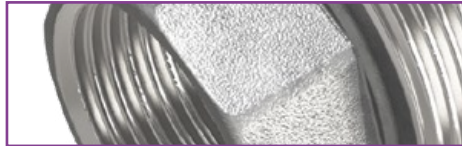

**ROSCADOS
THREADED**



FICHA TÉCNICA
TECHNICAL SHEET



8090

Codo 90° H-H

F-F elbow 90°

EAN CODE

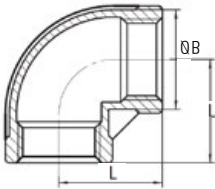

CÓDIGO CODE	MEDIDA SIZE	L	B	📦	📦
8090-008	1/4"	19	16,5	400	10
8090-010	3/8"	23	20	300	10
8090-015	1/2"	27	24,5	150	10
8090-020	3/4"	32	30	100	10
8090-025	1"	38	37,5	60	5
8090-032	1 1/4"	45	46,5	30	5
8090-040	1 1/2"	48	53	25	5
8090-050	2"	57	65,5	10	1
8090-065	2 1/2"	69	82	6	1
8090-080	3"	78	95,5	4	1
8090-100	4"	96	121,5	2	1

80902

Codo 90° H-H reducido

F-F reducing Elbow 90°

EAN CODE

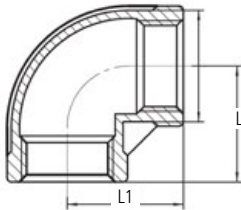

CÓDIGO CODE	MEDIDA SIZE	L	L1	📦	📦
80902-02015	3/4" x 1/2"	29	30	100	10

8092

Codo 90° M-H

M-F elbow 90°

EAN CODE

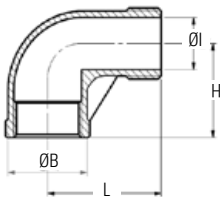

CÓDIGO CODE	MEDIDA SIZE	B	H	L	I	📦	📦
8092-006	1/8"	13	17	26	5,5	500	10
8092-008	1/4"	16,5	19	27	8	400	10
8092-010	3/8"	19,7	23	29	11,5	350	10
8092-015	1/2"	24,5	27	35	15	150	10
8092-020	3/4"	30	32	40	20,5	100	10
8092-025	1"	37,5	38	46	26	60	5
8092-032	1 1/4"	46,5	45	54	34,5	30	5
8092-040	1 1/2"	53	48	57	40	25	5
8092-050	2"	65,5	57	70	51	10	5
8092-065	2 1/2"	82	69	83	65,5	6	1
8092-080	3"	95,5	78	94	77,5	4	1
8092-100	4"	121,5	97	115	101,5	2	1

8120

Codo 45° H-H

F-F elbow 45°

EAN CODE

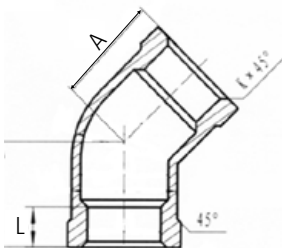

CÓDIGO CODE	MEDIDA SIZE	A	L	K	📦	📦
8120-008	1/4"	17	11	1	500	10
8120-010	3/8"	19	12,5	1	250	10
8120-015	1/2"	21	11	1,5	150	10
8120-020	3/4"	25	12	1,5	100	10
8120-025	1"	29	14	2	60	5
8120-032	1 1/4"	33	16	2	30	5
8120-040	1 1/2"	37	17	2	30	5
8120-050	2"	42	20	2	15	5

8130

Te 90° H

EAN CODE



F tee 90°

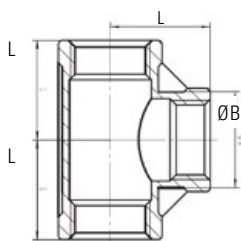

CÓDIGO CODE	MEDIDA SIZE	B	L	📦	📦
8130-008	1/4"	16,5	19	400	10
8130-010	3/8"	20	23	200	10
8130-015	1/2"	24,5	27	100	10
8130-020	3/4"	30	32	60	10
8130-025	1"	37,5	38	40	5
8130-032	1 1/4"	46,5	45	20	5
8130-040	1 1/2"	53	48	15	5
8130-050	2"	65,5	57	10	1
8130-065	2 1/2"	82	69	4	1
8130-080	3"	95,5	78	2	1
8130-100	4"	121,5	96	1	1

8132

Te reducida H

EAN CODE



F reduced tee

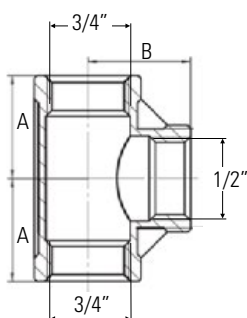

CÓDIGO CODE	MEDIDA SIZE	A	B	📦	📦
8132-02015	3/4" x 1/2"	29	30	60	10

8149

Entronque R-S de tubo

EAN CODE



M weld nipple from pipe

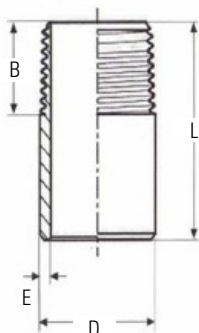

CÓDIGO CODE	MEDIDA SIZE	L	B	D	E	📦	📦
8149-008	1/4"	30	13	13,6	2	1000	10
8149-010	3/8"	30	13	17,2	2	600	10
8149-015	1/2"	35	16	21,3	2,6	450	10
8149-020	3/4"	40	16	26,9	2,6	240	10
8149-025	1"	40	19	33,7	3	140	5
8149-032	1 1/4"	50	21	42,4	3	70	5
8149-040	1 1/2"	50	22	48,3	4	60	5
8149-050	2"	50	26	60,3	3,9	36	1
8149-065	2 1/2"	60	30	76,1	4,6	18	1
8149-080	3"	70	34	88,9	5,4	12	1
8149-100	4"	80	39	114,3	5,7	6	1

8150

Entronque roscar M-M de tubo

EAN CODE



M-M pipe nipple from pipe

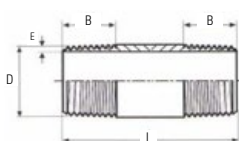

CÓDIGO CODE	MEDIDA SIZE	L	B	D	E	📦	📦
8150-008	1/4"	39	10	13,5	2	1000	10
8150-010	3/8"	41,3	11	17,1	2,2	400	10
8150-015	1/2"	55	14	21,3	2,9	260	10
8150-020	3/4"	60	17	26,9	2,9	160	10
8150-025	1"	60	18	32,6	3,2	100	5
8150-032	1 1/4"	75	21	42,4	3,2	40	5
8150-040	1 1/2"	75	24	47	3,2	40	5
8150-050	2"	90	26	58	3,6	24	5

8180

Cruz

EAN CODE



Cross

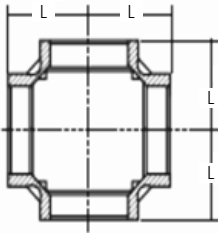

CÓDIGO CODE	MEDIDA SIZE	L	☐	☐
8180-008	1/4"	19	200	10
8180-010	3/8"	23	150	10
8180-015	1/2"	27	80	10
8180-020	3/4"	32	60	10
8180-025	1"	38	25	5
8180-032	1 1/4"	45	20	5
8180-040	1 1/2"	48	10	5
8180-050	2"	57	4	1
8180-065	2 1/2"	69	3	1
8180-080	3"	78	2	1
8180-100	4"	96	1	1

8240

Manguito reducción H-H

EAN CODE



F-F reduced Socket

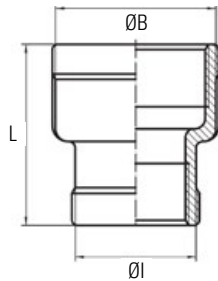

CÓDIGO CODE	MEDIDA SIZE	L	B	I	☐	☐
8240-00806	1/4" x 1/8"	25	16,5	13	600	10
8240-01006	3/8" x 1/8"	26	20	13	500	10
8240-01008	3/8" x 1/4"	26	20	16,5	500	10
8240-01506	1/2" x 1/8"	34	24,5	13	350	10
8240-01508	1/2" x 1/4"	34	24,5	16,5	350	10
8240-01510	1/2" x 3/8"	34	24,5	20	350	10
8240-02008	3/4" x 1/4"	36	30	16,5	300	10
8240-02010	3/4" x 3/8"	36	30	20	300	10
8240-02015	3/4" x 1/2"	36	30	24,5	200	10
8240-02508	1" x 1/4"	42	38	17	200	5
8240-02510	1" x 3/8"	42	38	20,5	200	5
8240-02515	1" x 1/2"	42	37,5	24,5	200	5
8240-02520	1" x 3/4"	42	37,5	30	130	5
8240-03215	1 1/4" x 1/2"	48	49	26	100	5
8240-03220	1 1/4" x 3/4"	48	46,5	30	100	5
8240-03225	1 1/4" x 1"	48	46,5	37,5	100	5
8240-04008	1 1/2" x 1/4"	52	53,5	17	60	5
8240-04010	1 1/2" x 3/8"	52	54,5	25,5	60	5
8240-04015	1 1/2" x 1/2"	52	59	26	60	5
8240-04020	1 1/2" x 3/4"	52	53	30	60	5
8240-04025	1 1/2" x 1"	52	53	37,5	60	5
8240-04032	1 1/2" x 1 1/4"	52	53	46,5	50	5
8240-05025	2" x 1"	58	68,3	39	40	1
8240-05032	2" x 1 1/4"	58	65,5	46,5	40	1
8240-05040	2" x 1 1/2"	58	65,5	53	40	1
8240-06525	2 1/2" x 1"	65	82	48	24	1
8240-06532	2 1/2" x 1 1/4"	65	84,5	48	24	1
8240-06540	2 1/2" x 1 1/2"	65	81,5	53	24	1
8240-06550	2 1/2" x 2"	65	81,5	65,5	24	1

8270

Manguito H-H de tubo

EAN CODE



F-F socket from pipe

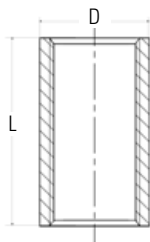

CÓDIGO CODE	MEDIDA SIZE	L	D	☐	☐
8270-008	1/4"	25	18,5	600	10
8270-010	3/8"	26	21,3	450	10
8270-015	1/2"	34	26,6	240	10
8270-020	3/4"	36	31,8	200	10
8270-025	1"	43	39,5	100	5
8270-032	1 1/4"	48	48,3	60	5
8270-040	1 1/2"	48	54,5	45	5
8270-050	2"	56	66,2	27	1
8270-065	2 1/2"	65	82	12	1
8270-080	3"	71	95	12	1
8270-100	4"	83	121,4	4	1

8241

Tuerca reducción M-H

EAN CODE

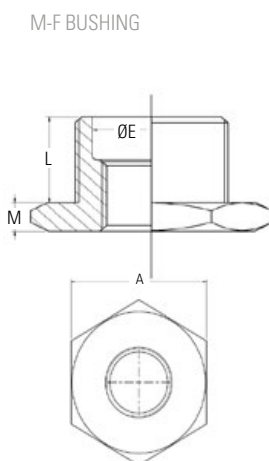

CÓDIGO CODE	MEDIDA SIZE	A	E	L	M		
8241-00806	1/4" x 1/8"	14,5	8	10,5	4	1000	10
8241-01006	3/8" x 1/8"	18,5	11,5	11	5	900	10
8241-01008	3/8" x 1/4"	18,5	11,5	11	5	900	10
8241-01506	1/2" x 1/8"	22,5	15	14,5	5	500	10
8241-01508	1/2" x 1/4"	22,5	15	14,5	5	500	10
8241-01510	1/2" x 3/8"	22,5	15	14,5	5	500	10
8241-02008	3/4" x 1/4"	28	20,5	15,5	5,5	350	10
8241-02010	3/4" x 3/8"	28	20,5	15,5	5,5	350	10
8241-02015	3/4" x 1/2"	28	20,5	15,5	5,5	350	10
8241-02508	1" x 1/4"	35	26	18	6	220	5
8241-02510	1" x 3/8"	35	26	18	6	220	5
8241-02515	1" x 1/2"	35	26	18	6	220	5
8241-02520	1" x 3/4"	35	26	18	6	220	5
8241-03215	1 1/4" x 1/2"	44	34,5	20,5	6,5	120	5
8241-03220	1 1/4" x 3/4"	44	34,5	20,5	6,5	120	5
8241-03225	1 1/4" x 1"	44	34,5	20,5	6,5	120	5
8241-04010	1 1/2" x 3/8"	49,5	20,5	20,5	6,5	90	5
8241-04015	1 1/2" x 1/2"	49,5	40	20,5	6,5	90	5
8241-04020	1 1/2" x 3/4"	49,5	40	20,5	6,5	90	5
8241-04025	1 1/2" x 1"	49,5	40	20,5	6,5	90	5
8241-04032	1 1/2" x 1 1/4"	49,5	40	20,5	6,5	90	5
8241-05015	2" x 1/2"	61,5	51	25	7	60	1
8241-05020	2" x 3/4"	61,5	51	25	7	60	1
8241-05025	2" x 1"	61,5	51	25	7	60	1
8241-05032	2" x 1 1/4"	61,5	51	25	7	60	1
8241-05040	2" x 1 1/2"	61,5	51	25	7	60	1
8241-06525	2 1/2" x 1"	77,5	51	27	7	24	1
8241-06540	2 1/2" x 1 1/2"	77,5	65,5	27	7	24	1
8241-06550	2 1/2" x 2"	77,5	65,5	27	7	24	1
8241-08040	3" x 1 1/2"	90,5	77,5	30	7,5	20	1
8241-08050	3" x 2"	90,5	77,5	30	7,5	20	1
8241-08065	3" x 2 1/2"	90,5	77,5	30	7,5	20	v1
8241-10050	4" x 2"	116,5	77,5	36	8	10	1
8241-10065	4" x 2 1/2"	116,5	101,5	36	8	10	1
8241-10080	4" x 3"	116,5	101,5	36	8	10	1

8280

Machón M-M

EAN CODE

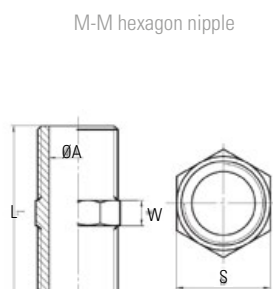

CÓDIGO CODE	MEDIDA SIZE	ØA	L	S	W		
8280-006	1/8"	5,5	28	12	7	1000	10
8280-008	1/4"	8	25	14	4,5	1000	10
8280-010	3/8"	11,5	27	18	5,5	600	10
8280-015	1/2"	15	34	22	5,5	380	10
8280-020	3/4"	20,5	36,5	28	5,5	200	10
8280-025	1"	26	42	34	6	140	5
8280-032	1 1/4"	34,5	47,5	44	6,5	60	5
8280-040	1 1/2"	40	47,5	50	6,5	50	5
8280-050	2"	51	57	61,5	7	36	1
8280-065	2 1/2"	65,5	61	77	7	18	1
8280-080	3"	77,5	67,5	90	7,5	12	1
8280-100	4"	103	80	120	8	4	1

8245

Machón reducido M-M

EAN CODE



M-M hexagon nipple reduced

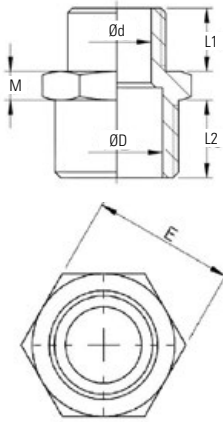

CÓDIGO CODE	MEDIDA SIZE	L1	L2	M	D	d	E	📦	📦
8245-00806	1/4" x 1/8"	8	10,5	4	8	5,5	14,5	800	10
8245-01006	3/8" x 1/8"	8	11	5	11,5	5,5	19	650	10
8245-01008	3/8" x 1/4"	11	11	5	11,5	8	19	650	10
8245-01506	1/2" x 1/8"	9	14,5	5	15,5	5,5	23	400	10
8245-01508	1/2" x 1/4"	11	14,5	5	15	8	23	400	10
8245-01510	1/2" x 3/8"	11	14,5	5	15	11,5	23	400	10
8245-02008	3/4" x 1/4"	12	15,5	5,5	21	8	28	300	10
8245-02010	3/4" x 3/8"	11	15,5	5,5	20,5	11,5	28	300	10
8245-02015	3/4" x 1/2"	14,5	15,5	5,5	20,5	15	28	300	10
8245-02508	1" x 1/4"	13,5	19	11	25,5	8	35	200	5
8245-02510	1" x 3/8"	13,5	18	7,5	26	11,5	35	200	5
8245-02515	1" x 1/2"	14,5	18	6	26	15	35	200	5
8245-02520	1" x 3/4"	15,5	18	6,5	26	20,5	35	200	5
8245-03215	1 1/4" x 1/2"	14,5	20,5	6,5	35	15	44	100	5
8245-03220	1 1/4" x 3/4"	15,5	20,5	6,5	34,5	20,5	44	100	5
8245-03225	1 1/4" x 1"	18	20,5	6,5	26	34,5	44	100	5
8245-04010	1 1/2" x 3/8"	13,5	20,5	6,5	40	12	51	80	5
8245-04015	1 1/2" x 1/2"	15	20,5	6,5	40	15	51	80	5
8245-04020	1 1/2" x 3/4"	15,5	20,5	6,5	40	20,5	51	70	5
8245-04025	1 1/2" x 1"	18	20,5	6,5	40	26	51	70	5
8245-04032	1 1/2" x 1 1/4"	20,5	20,5	6,5	40	34,5	51	50	5
8245-05015	2" x 1/2"	13,5	25	7	52	15,5	62	48	1
8245-05020	2" x 3/4"	15	25	7	52,5	21	62	48	1
8245-05025	2" x 1"	18	25	7	53	27	62	48	1
8245-05032	2" x 1 1/4"	20,5	25	7	51	34,5	62	48	1
8245-05040	2" x 1 1/2"	20,5	25	7	51	40	62	48	1
8245-06550	2 1/2" x 2"	25	27	7	65,5	51	78	20	1
8245-08050	3" x 2"	22	32	7,5	76,5	40	90,5	20	1
8245-08065	3" x 2 1/2"	25	30	8	77,5	51	90,5	20	1

8290

Tapón rosca M con reborde

EAN CODE



M hexagon plugs

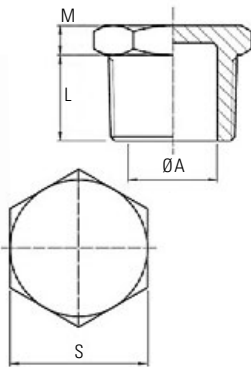

CÓDIGO CODE	MEDIDA SIZE	ØA	S	M	L	📦	📦
8290-008	1/4"	8	14,5	4	10,5	800	10
8290-010	3/8"	11,5	18	5	11	600	10
8290-015	1/2"	15	22	5	14,5	500	10
8290-020	3/4"	20,5	27,5	5,5	15,5	300	10
8290-025	1"	26	34,5	6	18	200	5
8290-032	1 1/4"	34,5	43,5	6,5	20,5	120	5
8290-040	1 1/2"	40	50,5	6,5	20,5	70	5
8290-050	2"	51	62,5	7	25	60	1
8290-065	2 1/2"	65,5	78,5	7	27	24	1
8290-080	3"	77,5	92	7,5	30	20	1
8290-100	4"	104	115,5	8	36	8	1

8300

Tapón hexagonal H

EAN CODE



F hexagon cap

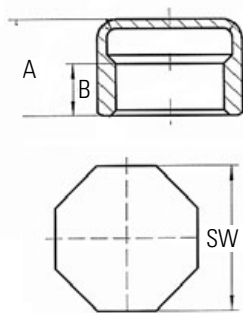

CÓDIGO CODE	MEDIDA SIZE	A	B	SW	📦	📦
8300-008	1/4"	16	14	16,5	1000	10
8300-010	3/8"	16,5	11,5	20	800	10
8300-015	1/2"	21	14,5	24,5	400	10
8300-020	3/4"	22	17	30	250	10
8300-025	1"	26	21	37	150	5
8300-032	1 1/4"	24	18	45,5	80	5
8300-040	1 1/2"	29	18	53	70	5
8300-050	2"	33	18	65	40	1
8300-065	2 1/2"	38	22	82	20	1
8300-080	3"	38,5	28	100	15	1
8300-100	4"	48	33	122	8	1

8312

Tuerca hexagonal

EAN CODE

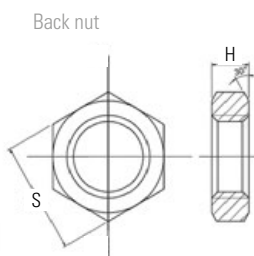

CÓDIGO CODE	MEDIDA SIZE	H	S	📦	📦
8312-008	1/4"	5,5	18	1000	10
8312-010	3/8"	6	23,5	1000	10
8312-015	1/2"	6,5	29,5	600	10
8312-020	3/4"	7	34	500	10
8312-025	1"	9	42,5	300	5
8312-032	1 1/4"	11	52	200	5
8312-040	1 1/2"	11	58	150	5
8312-050	2"	13	72	80	1

8330

Enlace tres piezas junta
plana PTFE H-H

EAN CODE

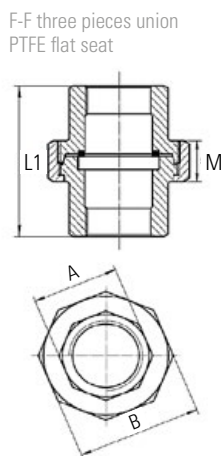

CÓDIGO CODE	MEDIDA SIZE	A	B	L1	M	📦	📦
8330-008	1/4"	16,5	29	33,5	13,5	200	10
8330-010	3/8"	20	34	36,5	15	120	10
8330-015	1/2"	24,5	37	40	16	100	10
8330-020	3/4"	30	44	42,5	17	70	10
8330-025	1"	37	52,5	50	20	40	5
8330-032	1 1/4"	46,5	64	54	22	30	5
8330-040	1 1/2"	53	70	58	24	25	5
8330-050	2"	65	84	65,5	27	15	1
8330-065	2 1/2"	85	108	75	29,5	8	1
8330-080	3"	96	118	83	31	6	1
8330-100	4"	125	152	110	34	3	1

- Asiento plano con junta PTFE
PTFE seat gasket

8340

Enlace tres piezas H-H

EAN CODE

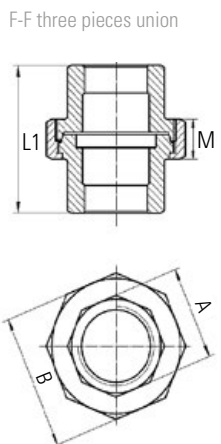

CÓDIGO CODE	MEDIDA SIZE	A	B	L1	M	📦	📦
8340-008	1/4"	16,5	29	33,5	13,5	200	10
8340-010	3/8"	20	34	36,5	15	120	10
8340-015	1/2"	24,5	37	40	16	100	10
8340-020	3/4"	30	44	42,5	17	70	10
8340-025	1"	37	52,5	50	20	40	10
8340-032	1 1/4"	46,5	64	54	22	30	5
8340-040	1 1/2"	53	70	58	24	25	5
8340-050	2"	65	84	65,5	27	15	5
8340-065	2 1/2"	82	101,5	75	29,5	8	1
8340-080	3"	96	118	83	31	6	1
8340-100	4"	125	152	90	31,5	3	1

- Asiento cónico
Tapered seat

8341

Enlace tres piezas M-H

EAN CODE

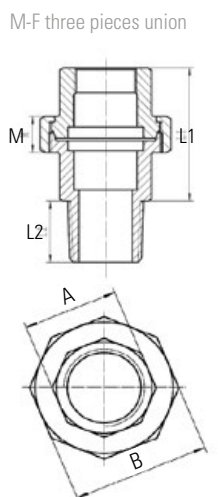

CÓDIGO CODE	MEDIDA SIZE	A	B	L1	L2	M	📦	📦
8341-008	1/4"	16,5	29	33,5	10,5	13,5	150	10
8341-010	3/8"	20	34	36,5	11	15	120	10
8341-015	1/2"	24,5	37	39,5	14,5	16	100	10
8341-020	3/4"	30	44	42,5	15,5	17	50	10
8341-025	1"	37	52,5	50	18	20	40	5
8341-032	1 1/4"	46,5	63	54	20,5	22	20	5
8341-040	1 1/2"	53	70	58	20,5	24	15	5
8341-050	2"	65	84	65	25	27	10	1
8341-065	2 1/2"	82	101,5	75	27	29,5	6	1
8341-080	3"	95,5	118	83	30	31	3	1
8341-100	4"	121,5	148,5	110	36	34	2	1

- Asiento cónico
Tapered seat

8399

Entronque manguera

Hexagon hose nipple

EAN CODE

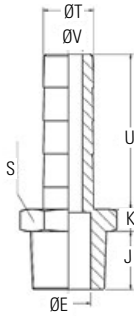

CÓDIGO CODE	MEDIDA SIZE	E	J	K	U	V	T	S		
8399-008	1/4" x 9	8	10,5	4	28	5	9	15	600	10
8399-010	3/8" x 11,5	11,5	11	5	33	7	11,5	18,5	500	10
8399-015	1/2" x 15	16	14	7	27	8,5	15	22	350	10
8399-020	3/4" x 20	20,5	15,5	5,5	45	15	20	28	150	10
8399-025	1" x 27	26	18	6	52	22	27	34	100	5
8399-032	1 1/4" x 33	34,5	20,5	6,5	52	27,5	33	44	50	5
8399-040	1 1/2" x 40	40	20	6,5	55	34	39	49,5	30	5
8399-050	2" x 53	51	25	7,5	60	45,5	52	61,5	20	1

8531

Manguito interior

Running nipple

EAN CODE

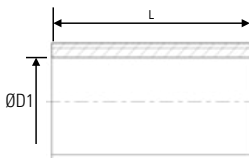

CÓDIGO CODE	MEDIDA SIZE	ØD1	L		
8531-008	1/4"	9,5	18	400	10
8531-010	3/8"	12,2	22	400	10
8531-015	1/2"	16,6	25	400	10
8531-020	3/4"	21,5	30	250	10
8531-025	1"	27	35	100	5
8531-032	1 1/4"	35,7	38	100	5
8531-040	1 1/2"	41,2	38	80	5
8531-050	2"	53	45	20	1
8531-065	2 1/2"	69,3	51	20	1
8531-080	3"	80,5	60	10	1
8531-100	4"	105,3	70	10	1

8601

Entronque rosca manguera

Threaded hose coupling

EAN CODE

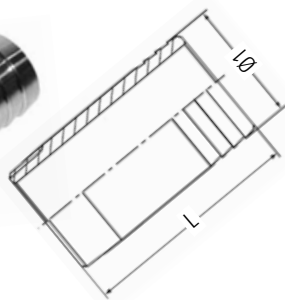

CÓDIGO CODE	MEDIDA SIZE	Ø1	L		
8601-008	1/4"	13,5	70	400	10
8601-010	3/8"	17,2	70	200	10
8601-015	1/2"	21,3	70	200	10
8601-020	3/4"	26,9	70	120	10
8601-025	1"	33,7	70	50	5
8601-032	1 1/4"	42,4	70	30	1
8601-040	1 1/2"	48,3	100	20	5
8601-050	2"	60,3	100	18	1

8602

Entronque doble manguera

Hose coupling

EAN CODE

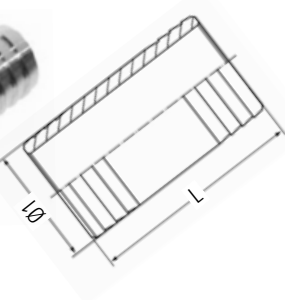

CÓDIGO CODE	MEDIDA SIZE	Ø1	L		
8602-008	1/4"	13,5	66	400	10
8602-010	3/8"	17,2	76	200	10
8602-015	1/2"	21,3	86	200	10
8602-020	3/4"	26,9	100	100	10
8602-025	1"	33,7	114	50	5
8602-032	1 1/4"	42,4	114	35	1
8602-040	1 1/2"	48,3	122	25	1
8602-050	2"	60,3	130	25	1

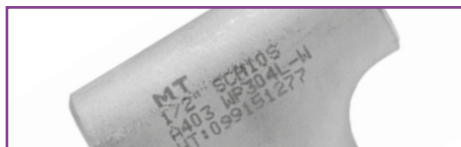

SOLDADOS SOLDERED



FICHA TÉCNICA TECHNICAL SHEET

S09014 SCH 10 A-304L

Codo 90° radio largo

Elbow 90° long radius

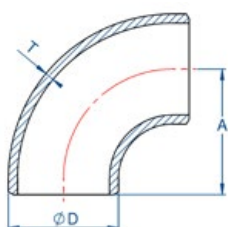

CÓDIGO CODE	MEDIDA SIZE	D	T Sch 10	A	
S09014-015	1/2"	21,34	2,11	38,1	1
S09014-020	3/4"	26,67	2,11	38,1	1
S09014-025	1"	33,4	2,77	38,1	1
S09014-032	1 1/4"	42,16	2,77	47,75	1
S09014-040	1 1/2"	48,26	2,77	57,15	1
S09014-050	2"	60,33	2,77	76,2	1
S09014-065	2 1/2"	73,03	3,05	95,25	1
S09014-080	3"	88,9	3,05	114,3	1
S09014-100	4"	114,3	3,05	152,4	1
S09014-125	5"	141,3	3,4	190,5	1
S09014-150	6"	168,28	3,4	228,6	1
S09014-200	8"	219,08	3,76	304,08	1
S09014-250	10"	273,05	4,19	381	1
S09014-300	12"	323,85	4,57	457,2	1

S09016 SCH 10 A-316L

Codo 90° radio largo

Elbow 90° long radius

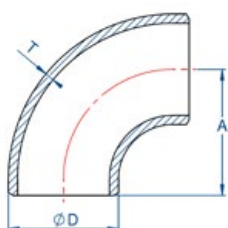

CÓDIGO CODE	MEDIDA SIZE	D	T Sch 10	A	
S09016-015	1/2"	21,34	2,11	38,1	1
S09016-020	3/4"	26,67	2,11	38,1	1
S09016-025	1"	33,4	2,77	38,1	1
S09016-032	1 1/4"	42,16	2,77	47,75	1
S09016-040	1 1/2"	48,26	2,77	57,15	1
S09016-050	2"	60,33	2,77	76,2	1
S09016-065	2 1/2"	73,03	3,05	95,25	1
S09016-080	3"	88,9	3,05	114,3	1
S09016-100	4"	114,3	3,05	152,4	1
S09016-125	5"	141,3	3,4	190,5	1
S09016-150	6"	168,28	3,4	228,6	1
S09016-200	8"	219,08	3,76	304,08	1
S09016-250	10"	273,05	4,19	381	1
S09016-300	12"	323,85	4,57	457,2	1

SS09016 SCH 10 A-316L **NEW**

Codo 90° radio largo sin soldadura

Elbow 90° long radius seamless

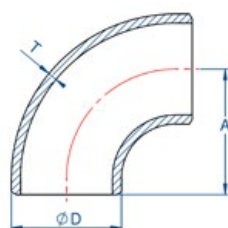

CÓDIGO CODE	MEDIDA SIZE	D1	D2	H	Sch 10		
					T1	T2	
SS09016-015	1/2"	26,67	21,34	38	2,87	2,77	1
SS09016-020	3/4"	33,4	21,34	51	3,38	2,77	1
SS09016-025	1"	33,4	26,67	51	3,38	2,87	1
SS09016-032	1 1/4"	42,16	26,67	51	3,56	2,87	1
SS09016-040	1 1/2"	42,16	33,4	51	3,56	3,38	1
SS09016-050	2"	48,26	26,67	64	3,68	2,87	1
SS09016-065	2 1/2"	48,26	33,4	64	3,68	3,38	1
SS09016-080	3"	48,26	42,16	64	3,68	3,56	1

S13014

SCH 10 A-304L

Te



Tee

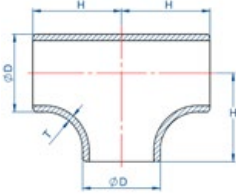

CÓDIGO CODE	MEDIDA SIZE	D	T Sch 10	H	
S13014-015	1/2"	21,34	2,11	25	1
S13014-020	3/4"	26,67	2,11	29	1
S13014-025	1"	33,4	2,77	38	1
S13014-032	1 1/4"	42,16	2,77	48	1
S13014-040	1 1/2"	48,26	2,77	57	1
S13014-050	2"	60,33	2,77	64	1
S13014-065	2 1/2"	73,03	3,05	75	1
S13014-080	3"	88,9	3,05	86	1
S13014-100	4"	114,3	3,05	105	1
S13014-125	5"	141,3	3,4	124	1
S13014-150	6"	168,28	3,4	143	1
S13014-200	8"	219,08	3,76	178	1
S13014-250	10"	273,05	4,19	216	1
S13014-300	12"	323,85	4,57	254	1

S13016

SCH 10 A-316L

Te



Tee

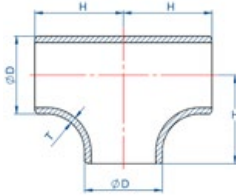

CÓDIGO CODE	MEDIDA SIZE	D	T Sch 10	H	
S13016-015	1/2"	21,34	2,11	25	1
S13016-020	3/4"	26,67	2,11	29	1
S13016-025	1"	33,4	2,77	38	1
S13016-032	1 1/4"	42,16	2,77	48	1
S13016-040	1 1/2"	48,26	2,77	57	1
S13016-050	2"	60,33	2,77	64	1
S13016-065	2 1/2"	73,03	3,05	75	1
S13016-080	3"	88,9	3,05	86	1
S13016-100	4"	114,3	3,05	105	1
S13016-125	5"	141,3	3,4	124	1
S13016-150	6"	168,28	3,4	143	1
S13016-200	8"	219,08	3,76	178	1
S13016-250	10"	273,05	4,19	216	1
S13016-300	12"	323,85	4,57	254	1

SS13016

SCH 10 A-316L



Te sin soldadura



Tee seamless

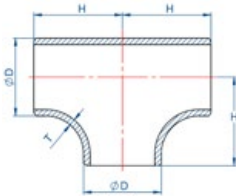

CÓDIGO CODE	MEDIDA SIZE	D1	D2	H	Sch 10		
					T1	T2	
SS13016-015	1/2"	26,67	21,34	38	2,87	2,77	1
SS13016-020	3/4"	33,4	21,34	51	3,38	2,77	1
SS13016-025	1"	33,4	26,67	51	3,38	2,87	1
SS13016-032	1 1/4"	42,16	26,67	51	3,56	2,87	1
SS13016-040	1 1/2"	42,16	33,4	51	3,56	3,38	1
SS13016-050	2"	48,26	26,67	64	3,68	2,87	1
SS13016-065	2 1/2"	48,26	33,4	64	3,68	3,38	1
SS13016-080	3"	48,26	42,16	64	3,68	3,56	1

S29614
SCH 10 A-304L

Stub end tipo A



Stub end A type

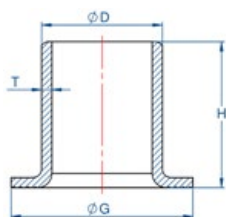

CÓDIGO CODE	MEDIDA SIZE	D	G	T Sch 10	H	
S29614-015	1/2"	21,34	35	2,11	51	1
S29614-020	3/4"	26,67	43	2,11	51	1
S29614-025	1"	33,4	50,8	2,77	51	1
S29614-032	1 1/4"	42,16	63,5	2,77	51	1
S29614-040	1 1/2"	48,26	73	2,77	51	1
S29614-050	2"	60,33	92	2,77	63,5	1
S29614-065	2 1/2"	73,03	105	3,05	63,5	1
S29614-080	3"	88,9	127	3,05	63,5	1
S29614-100	4"	114,3	157	3,05	76	1

S29616
SCH 10 A-316L

Stub end tipo A



Stub end A type

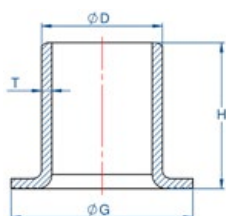

CÓDIGO CODE	MEDIDA SIZE	D	G	T Sch 10	H	
S29616-015	1/2"	21,34	35	2,11	51	1
S29616-020	3/4"	26,67	43	2,11	51	1
S29616-025	1"	33,4	50,8	2,77	51	1
S29616-032	1 1/4"	42,16	63,5	2,77	51	1
S29616-040	1 1/2"	48,26	73	2,77	51	1
S29616-050	2"	60,33	92	2,77	63,5	1
S29616-065	2 1/2"	73,03	105	3,05	63,5	1
S29616-080	3"	88,9	127	3,05	63,5	1
S29616-100	4"	114,3	157	3,05	76	1

S24014
SCH 10 A-304L

Reducción concéntrica



Concentric reducer

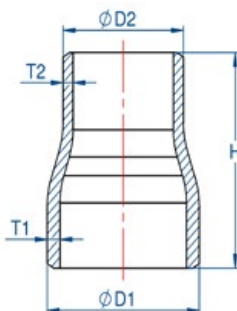

CÓDIGO CODE	MEDIDA SIZE	D1	D2	H	Sch 10		
					T1	T2	
S24014-020015	3/4" x 1/2"	26,67	21,34	38	2,11	2,11	1
S24014-025015	1" x 1/2"	33,4	21,34	51	2,77	2,11	1
S24014-025020	1" x 3/4"	33,4	26,67	51	2,77	2,11	1
S24014-032020	1 1/4" x 3/4"	42,16	26,67	51	2,77	2,11	1
S24014-032025	1 1/4" x 1"	42,16	33,4	51	2,77	2,77	1
S24014-040020	1 1/2" x 3/4"	48,26	26,67	64	2,77	2,11	1
S24014-040025	1 1/2" x 1"	48,26	33,4	64	2,77	2,77	1
S24014-040032	1 1/2" x 1 1/4"	48,26	42,16	64	2,77	2,77	1
S24014-050020	2" x 3/4"	60,32	26,67	76	2,77	2,11	1
S24014-050025	2" x 1"	60,32	33,4	76	2,77	2,77	1
S24014-050032	2" x 1 1/4"	60,32	42,16	76	2,77	2,77	1
S24014-050040	2" x 1 1/2"	60,32	48,26	76	2,77	2,77	1
S24014-065025	2 1/2" x 1"	73,02	33,4	89	3,05	2,77	1
S24014-065032	2 1/2" x 1 1/4"	73,02	42,16	89	3,05	2,77	1
S24014-065040	2 1/2" x 1 1/2"	73,02	48,26	89	3,05	2,77	1
S24014-065050	2 1/2" x 2"	73,02	60,32	89	3,05	2,77	1
S24014-080040	3" x 1 1/2"	88,9	48,26	89	3,05	2,77	1
S24014-080050	3" x 2"	88,9	60,32	89	3,05	2,77	1
S24014-080065	3" x 2 1/2"	88,9	73,02	89	3,05	3,05	1
S24014-100050	4" x 2"	114,3	60,32	102	3,05	2,77	1
S24014-100065	4" x 2 1/2"	114,3	73,02	102	3,05	3,05	1
S24014-100080	4" x 3"	114,3	88,9	102	3,05	3,05	1
S24014-125080	5" x 3"	141,3	88,9	127	3,4	3,05	1
S24014-125100	5" x 4"	141,3	114,3	127	3,4	3,05	1
S24014-150100	6" x 4"	168,27	114,3	140	3,4	3,05	1
S24014-150125	6" x 5"	168,27	141,3	140	3,4	3,4	1
S24014-200100	8" x 4"	219,08	114,3	152	3,76	3,05	1
S24014-200125	8" x 5"	219,08	141,3	152	3,76	3,4	1
S24014-200150	8" x 6"	219,08	168,27	152	3,76	3,4	1
S24014-250200	10" x 8"	273,05	219,08	178	4,19	3,76	1
S24014-300250	12" x 10"	323,85	273,05	203	4,57	4,19	1

S24016
SCH 10 A-316L

Reducción concéntrica

Concentric reducer

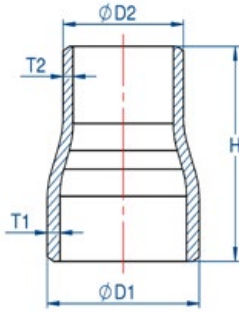

CÓDIGO CODE	MEDIDA SIZE	D1	D2	H	Sch 10		📦
					T1	T2	
S24016-020015	3/4" x 1/2"	26,67	21,34	38	2,11	2,11	1
S24016-025015	1" x 1/2"	33,4	21,34	51	2,77	2,11	1
S24016-025020	1" x 3/4"	33,4	26,67	51	2,77	2,11	1
S24016-032020	1 1/4" x 3/4"	42,16	26,67	51	2,77	2,11	1
S24016-032025	1 1/4" x 1"	42,16	33,4	51	2,77	2,77	1
S24016-040020	1 1/2" x 3/4"	48,26	26,67	64	2,77	2,11	1
S24016-040025	1 1/2" x 1"	48,26	33,4	64	2,77	2,77	1
S24016-040032	1 1/2" x 1 1/4"	48,26	42,16	64	2,77	2,77	1
S24016-050020	2" x 3/4"	60,32	26,67	76	2,77	2,11	1
S24016-050025	2" x 1"	60,32	33,4	76	2,77	2,77	1
S24016-050032	2" x 1 1/4"	60,32	42,16	76	2,77	2,77	1
S24016-050040	2" x 1 1/2"	60,32	48,26	76	2,77	2,77	1
S24016-065025	2 1/2" x 1"	73,02	33,4	89	3,05	2,77	1
S24016-065032	2 1/2" x 1 1/4"	73,02	42,16	89	3,05	2,77	1
S24016-065040	2 1/2" x 1 1/2"	73,02	48,26	89	3,05	2,77	1
S24016-065025	2 1/2" x 1"	73,02	33,4	89	3,05	2,77	1
S24016-065032	2 1/2" x 1 1/4"	73,02	42,16	89	3,05	2,77	1
S24016-065040	2 1/2" x 1 1/2"	73,02	48,26	89	3,05	2,77	1
S24016-065050	2 1/2" x 2"	73,02	60,32	89	3,05	2,77	1
S24016-080040	3" x 1 1/2"	88,9	48,26	89	3,05	2,77	1
S24016-080050	3" x 2"	88,9	60,32	89	3,05	2,77	1
S24016-080065	3" x 2 1/2"	88,9	73,02	89	3,05	3,05	1
S24016-100050	4" x 2"	114,3	60,32	102	3,05	2,77	1
S24016-100065	4" x 2 1/2"	114,3	73,02	102	3,05	3,05	1
S24016-100080	4" x 3"	114,3	88,9	102	3,05	3,05	1
S24016-125080	5" x 3"	141,3	88,9	127	3,4	3,05	1
S24016-125100	5" x 4"	141,3	114,3	127	3,4	3,05	1
S24016-150100	6" x 4"	168,27	114,3	140	3,4	3,05	1
S24016-150125	6" x 5"	168,27	141,3	140	3,4	3,4	1
S24016-200100	8" x 4"	219,08	114,3	152	3,76	3,05	1
S24016-200125	8" x 5"	219,08	141,3	152	3,76	3,4	1
S24016-200150	8" x 6"	219,08	168,27	152	3,76	3,4	1
S24016-250200	10" x 8"	273,05	219,08	178	4,19	3,76	1
S24016-300250	12" x 10"	323,85	273,05	203	4,57	4,19	1

SS24016 **NEW**
SCH 10 A-316L

Reducción concéntrica
sin soldadura

Concentric reducer
seamless

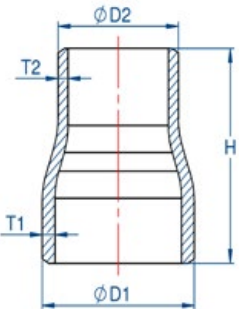

CÓDIGO CODE	MEDIDA SIZE	D1	D2	H	Sch 10		📦
					T1	T2	
SS24016-025015	1" x 1/2"	26,67	21,34	38	2,87	2,77	1
SS24016-025020	1" x 3/4"	33,4	21,34	51	3,38	2,77	1
SS24016-032020	1 1/4" x 3/4"	33,4	26,67	51	3,38	2,87	1
SS24016-032025	1 1/4" x 1"	42,16	26,67	51	3,56	2,87	1
SS24016-040020	1 1/2" x 3/4"	42,16	33,4	51	3,56	3,38	1
SS24016-040025	1 1/2" x 1"	48,26	26,67	64	3,68	2,87	1
SS24016-040032	1 1/2" x 1 1/4"	48,26	33,4	64	3,68	3,38	1
SS24016-050025	2" x 1"	48,26	42,16	64	3,68	3,56	1
SS24016-050032	2" x 1 1/4"	48,26	42,16	64	3,68	3,56	1
SS24016-050040	2x 1 1/2"	48,26	42,16	64	3,68	3,56	1
SS24016-065050	2 1/2" x 2"	48,26	42,16	64	3,68	3,56	1
SS24016-080040	3" x 1 1/2"	48,26	42,16	64	3,68	3,56	1
SS24016-080050	3" x 2"	48,26	42,16	64	3,68	3,56	1
SS24016-080065	3" x 2 1/2"	48,26	42,16	64	3,68	3,56	1

S29014

SCH 10 A-304L

Tapón

Cap

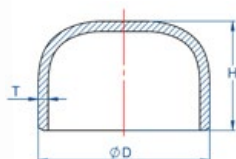

CÓDIGO CODE	MEDIDA SIZE	D	T Sch 10	H	
S29014-015	1/2"	21,34	2,11	25	1
S29014-020	3/4"	26,67	2,11	25	1
S29014-025	1"	33,4	2,77	38	1
S29014-032	1 1/4"	42,16	2,77	38	1
S29014-040	1 1/2"	48,26	2,77	38	1
S29014-050	2"	60,33	2,77	38	1
S29014-065	2 1/2"	73,03	3,05	38	1
S29014-080	3"	88,9	3,05	51	1
S29014-100	4"	114,3	3,05	64	1
S29014-125	5"	141,3	3,4	76	1
S29014-150	6"	168,28	3,4	89	1
S29014-200	8"	219,08	3,76	102	1
S29014-250	10"	273,05	4,19	127	1
S29014-300	12"	323,85	4,57	152	1

S29016

SCH 10 A-316L

Tapón

Cap

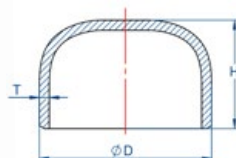

CÓDIGO CODE	MEDIDA SIZE	D	T Sch 10	H	
S29016-015	1/2"	21,34	2,11	25	1
S29016-020	3/4"	26,67	2,11	25	1
S29016-025	1"	33,4	2,77	38	1
S29016-032	1 1/4"	42,16	2,77	38	1
S29016-040	1 1/2"	48,26	2,77	38	1
S29016-050	2"	60,33	2,77	38	1
S29016-065	2 1/2"	73,03	3,05	38	1
S29016-080	3"	88,9	3,05	51	1
S29016-100	4"	114,3	3,05	64	1
S29016-125	5"	141,3	3,4	76	1
S29016-150	6"	168,28	3,4	89	1
S29016-200	8"	219,08	3,76	102	1
S29016-250	10"	273,05	4,19	127	1
S29016-300	12"	323,85	4,57	152	1

S09046

SCH 40 A-316L

Codo 90° radio largo

Elbow 90° long radius

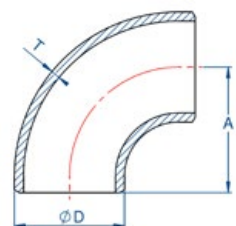

CÓDIGO CODE	MEDIDA SIZE	D	T Sch 40	A	
S09046-015	1/2"	21,34	2,77	38,1	1
S09046-020	3/4"	26,67	2,87	38,1	1
S09046-025	1"	33,4	3,38	38,1	1
S09046-032	1 1/4"	42,16	3,56	47,75	1
S09046-040	1 1/2"	48,26	3,68	57,15	1
S09046-050	2"	60,33	3,91	76,2	1
S09046-065	2 1/2"	73,03	5,16	95,25	1
S09046-080	3"	88,9	5,49	114,3	1
S09046-100	4"	114,3	6,02	152,4	1
S09046-125	5"	141,3	6,55	190,5	1
S09046-150	6"	168,28	7,11	228,6	1
S09046-200	8"	219,08	8,18	304,08	1
S09046-250	10"	273,05	9,27	381	1

S13046

SCH 40 A-316L

Te

Tee

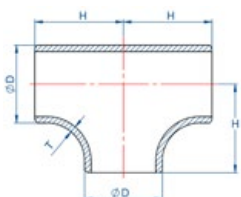

CÓDIGO CODE	MEDIDA SIZE	D	T Sch 40	H	
S13046-015	1/2"	21,34	2,77	25	1
S13046-020	3/4"	26,67	2,87	29	1
S13046-025	1"	33,4	3,38	38	1
S13046-032	1 1/4"	42,16	3,56	48	1
S13046-040	1 1/2"	48,26	3,68	57	1
S13046-050	2"	60,33	3,91	64	1
S13046-065	2 1/2"	73,03	5,16	75	1
S13046-080	3"	88,9	5,49	86	1
S13046-100	4"	114,3	6,02	105	1
S13046-125	5"	141,3	6,55	124	1
S13046-150	6"	168,28	7,11	143	1
S13046-200	8"	219,08	8,18	178	1
S13046-250	10"	273,05	9,27	216	1

S29046
SCH 40 A-316L

Tapón

Cap

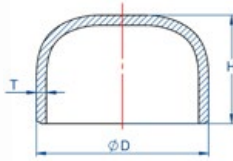

CÓDIGO CODE	MEDIDA SIZE	D	T Sch 40	H	
S29046-015	1/2"	21,34	2,77	25	1
S29046-020	3/4"	26,67	2,87	25	1
S29046-025	1"	33,4	3,38	38	1
S29046-032	1 1/4"	42,16	3,56	38	1
S29046-040	1 1/2"	48,26	3,68	38	1
S29046-050	2"	60,33	3,91	38	1
S29046-065	2 1/2"	73,03	5,16	38	1
S29046-080	3"	88,9	5,49	51	1
S29046-100	4"	114,3	6,02	64	1
S29046-125	5"	141,3	6,55	76	1
S29046-150	6"	168,28	7,11	89	1
S29046-200	8"	219,08	8,18	102	1
S29046-250	10"	273,05	9,27	127	1

S29646
SCH 40 A-316L

Stub end tipo A

Stub end A type

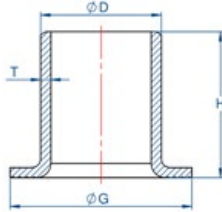

CÓDIGO CODE	MEDIDA SIZE	D	G	H	T Sch 40	
S29646-015	1/2"	21,34	35	51	2,77	1
S29646-020	3/4"	26,67	43	51	2,87	1
S29646-025	1"	33,4	50,8	51	3,38	1
S29646-032	1 1/4"	42,16	63,5	51	3,56	1
S29646-040	1 1/2"	48,26	73	51	3,68	1
S29646-050	2"	60,33	92	63,5	3,91	1
S29646-065	2 1/2"	73,03	105	63,5	5,16	1
S29646-080	3"	88,9	127	63,5	5,49	1
S29646-100	4"	114,3	157	76	6,02	1

S24046
SCH 40 A-316L

Reducción concéntrica

Concentric reducer

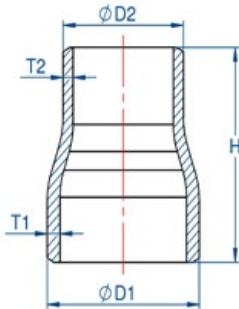

CÓDIGO CODE	MEDIDA SIZE	D1	D2	H	Sch 40		
					T1	T2	
S24046-020015	3/4" x 1/2"	26,67	21,34	38	2,87	2,77	1
S24046-025015	1" x 1/2"	33,4	21,34	51	3,38	2,77	1
S24046-025020	1" x 3/4"	33,4	26,67	51	3,38	2,87	1
S24046-032020	1 1/4" x 3/4"	42,16	26,67	51	3,56	2,87	1
S24046-032025	1 1/4" x 1"	42,16	33,4	51	3,56	3,38	1
S24046-040020	1 1/2" x 3/4"	48,26	26,67	64	3,68	2,87	1
S24046-040025	1 1/2" x 1"	48,26	33,4	64	3,68	3,38	1
S24046-040032	1 1/2" x 1 1/4"	48,26	42,16	64	3,68	3,56	1
S24046-050020	2" x 3/4"	60,32	26,67	76	3,91	2,87	1
S24046-050025	2" x 1"	60,32	33,4	76	3,91	3,38	1
S24046-050032	2" x 1 1/4"	60,32	42,16	76	3,91	3,56	1
S24046-050040	2" x 1 1/2"	60,32	48,26	76	3,91	3,68	1
S24046-065025	2 1/2" x 1"	73,02	33,4	89	5,16	3,38	1
S24046-065032	2 1/2" x 1 1/4"	73,02	42,16	89	5,16	3,56	1
S24046-065040	2 1/2" x 1 1/2"	73,02	48,26	89	5,16	3,68	1
S24046-065050	2 1/2" x 2"	73,02	60,32	89	5,16	3,91	1
S24046-080040	3" x 1 1/2"	88,9	48,26	89	5,49	3,68	1
S24046-080050	3" x 2"	88,9	60,32	89	5,49	3,91	1
S24046-080065	3" x 2 1/2"	88,9	73,02	89	5,49	5,16	1
S24046-100050	4" x 2"	114,3	60,32	102	6,02	3,91	1
S24046-100065	4" x 2 1/2"	114,3	73,02	102	6,02	5,16	1
S24046-100080	4" x 3"	114,3	88,9	102	6,02	5,49	1
S24046-125080	5" x 3"	141,3	88,9	127	6,55	5,49	1
S24046-125100	5" x 4"	141,3	114,3	127	6,55	6,02	1
S24046-150100	6" x 4"	168,27	114,3	140	7,11	6,02	1
S24046-150125	6" x 5"	168,27	141,3	140	7,11	6,55	1
S24046-200100	8" x 4"	219,08	114,3	152	8,18	6,02	1
S24046-200125	8" x 5"	219,08	141,3	152	8,18	6,55	1
S24046-200150	8" x 6"	219,08	168,27	152	8,18	7,11	1
S24046-250200	10" x 8"	273,05	219,08	178	9,27	8,18	1



BRIDAS FLANGES

BRIDA PLANA PARA SOLDAR EN-1092-1 TIPO: 01A PN-10 PLATE FLANGE FOR WELDING EN-1092-1 TYPE: 01A PN-10
BRIDA FORJADA DE ACERO INOXIDABLE STAINLESS STEEL FORGET FLANGE

01A PN10 MM A304L

Brida forjada plana para soldar
Material: acero inoxidable EN 1.4307 / A304L
Tubo milimétrico

Plate flange for welding EN-1092-1 Type: 01A
Material: stainless steel EN 1.4307 / A304L
Milimetric pipe



CÓDIGO CODE	DN	PN
01A61014015	15	10-16-25-40
01A61014020	20	10-16-25-40
01A61014025	25	10-16-25-40
01A61014032	32	10-16-25-40
01A61014040	40	10-16-25-40
01A61014050	50	10-16
01A61014065	65	10-16
01A61014080	80	10-16
01A61014100	100	10-16
01A61014125	125	10-16
01A61014150	150	10-16
01A10014200	200	10
01A10014250	250	10
01A10014300	300	10
01A10004350	350	10
01A10004400	400	10
01A10004450	450	10
01A10004500	500	10
01A10004600	600	10
01A10004700	700	10
01A10004800	800	10
01A10004900	900	10
01A10004000	1000	10

01A PN10 MM A316L

Brida forjada plana para soldar
Material: acero inoxidable EN 1.4404 / A316L
Tubo milimétrico

Plate flange for welding EN-1092-1 Type: 01A
Material: stainless steel EN 1.4404 / A316L
Milimetric pipe



CÓDIGO CODE	DN	PN
01A61016015	15	10-16-25-40
01A61016020	20	10-16-25-40
01A61016025	25	10-16-25-40
01A61016032	32	10-16-25-40
01A61016040	40	10-16-25-40
01A61016050	50	10-16
01A61016065	65	10-16
01A61016080	80	10-16
01A61016100	100	10-16
01A61016125	125	10-16
01A61016150	150	10-16
01A10016200	200	10
01A10016250	250	10
01A10016300	300	10
01A10006350	350	10
01A10006400	400	10
01A10006450	450	10
01A10006500	500	10
01A10006600	600	10
01A10006700	700	10
01A10006800	800	10
01A10006900	900	10
01A10006000	1000	10

01A PN10 ISO A304L

Brida forjada plana para soldar
Material: acero inoxidable EN 1.4307 / A304L
Tubo ISO

Plate flange for welding EN-1092-1 Type: 01A
Material: stainless steel EN 1.4307 / A304L
ISO pipe



CÓDIGO CODE	DN	PN
01A61024015	15	10-16-25-40
01A61024020	20	10-16-25-40
01A61024025	25	10-16-25-40
01A61024032	32	10-16-25-40
01A61024040	40	10-16-25-40
01A61024050	50	10-16
01A61024065	65	10-16
01A61024080	80	10-16
01A61024100	100	10-16
01A61024125	125	10-16
01A61024150	150	10-16
01A10024200	200	10
01A10024250	250	10
01A10024300	300	10
01A10004350	350	10
01A10004400	400	10
01A10004450	450	10
01A10004500	500	10
01A10004600	600	10
01A10004700	700	10
01A10004800	800	10
01A10004900	900	10
01A10004000	1000	10

01A PN10 ISO A316L

Brida forjada plana para soldar
Material: acero inoxidable EN 1.4404 / A316L
Tubo ISO

Plate flange for welding EN-1092-1 Type: 01A
Material: stainless steel EN 1.4404 / A316L
ISO pipe



CÓDIGO CODE	DN	PN
01A61026015	15	10-16-25-40
01A61026020	20	10-16-25-40
01A61026025	25	10-16-25-40
01A61026032	32	10-16-25-40
01A61026040	40	10-16-25-40
01A61026050	50	10-16
01A61026065	65	10-16
01A61026080	80	10-16
01A61026100	100	10-16
01A61026125	125	10-16
01A61026150	150	10-16
01A10026200	200	10
01A10026250	250	10
01A10026300	300	10
01A10006350	350	10
01A10006400	400	10
01A10006450	450	10
01A10006500	500	10
01A10006600	600	10
01A10006700	700	10
01A10006800	800	10
01A10006900	900	10
01A10006000	1000	10

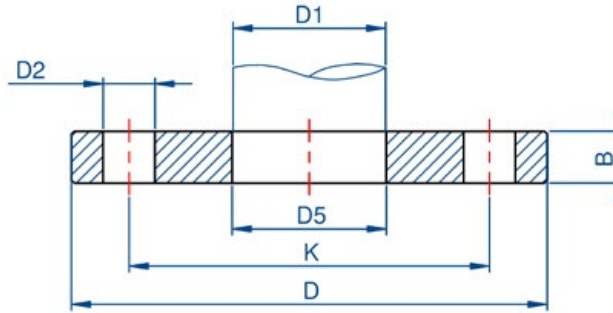

DN	PN	TUBO PIPE			BRIDA FLANGE			TORNILLOS BOLTS			PESO WEIGHT HT (7,85kg/m3)
		TIPO TYPE	D1	D5	D	B	K	nº	ROSCA THREAD	D2	
15	10-16-25-40	ISO	21,3	22	95	14	65	4	M12	14	0,67
		MM	18	18,5	95	14	65	4	M12	14	0,69
20	10-16-25-40	ISO	26,9	27,5	105	16	75	4	M12	14	0,94
		MM	23	23,5	105	16	75	4	M12	14	0,97
25	10-16-25-40	ISO	33,7	34,5	115	16	85	4	M12	14	1,11
		MM	28	28,5	115	16	85	4	M12	14	1,16
32	10-16-25-40	ISO	42,4	43,5	140	18 (16)	100	4	M16	18	1,62
		MM	38	38,5	140	18 (16)	100	4	M16	18	1,68
40	10-16-25-40	ISO	48,3	49,5	150	18 (16)	110	4	M16	18	1,86
		MM	43	43,5	150	18 (16)	110	4	M16	18	1,92
50	10-16	ISO	60,3	61,5	165	20 (18)	125	4	M16	18	2,47
		MM	53	53,5	165	20 (18)	125	4	M16	18	2,59
65	10-16	ISO	76,1	77,5	185	20 (18)	145	8 (4)	M16	18	3
		MM	73	73,7	185	20 (18)	145	8 (4)	M16	18	3,08
80	10-16	ISO	88,9	90,5	200	20	160	8	M16	18	3,79
		MM	84	84,7	200	20	160	8	M16	18	3,77
100	10-16	ISO	114,3	116	220	22 (20)	180	8	M16	18	4,03
		MM	104	104,8	220	22 (20)	180	8	M16	18	4,34
125	10-16	ISO	139,7	141,5	250	22	210	8	M16	18	5,46
		MM	129	130	250	22	210	8	M16	18	5,89
150	10-16	ISO	168,3	170,5	285	24 (22)	240	8	M20	22	6,57
		MM	154	156	285	24 (22)	240	8	M20	22	7,27
200	10	ISO	219,1	221,5	340	24	295	8	M20	22	9,31
		MM	204	206	340	24	295	8	M20	22	10,36
250	10	ISO	273	276,5	395	26	350	12	M20	22	11,9
		MM	254	256	395	26	350	12	M20	22	13,72
300	10	ISO	323,9	327,5	445	26	400	12	M20	22	13,8
		MM	304	307	445	26	400	12	M20	22	15,87
350	10	ISO	355,6	359,5	505	30 (28)	460	16	M20	22	20,6
		MM	354	359,5	505	30 (28)	460	16	M20	22	20,6
400	10	ISO	406,4	411	565	32	515	16	M24	26	27,9
		MM	406	411	565	32	515	16	M24	26	27,9
450	10	ISO	457	462,3	615	36 (38)	565	20	M24	26	35,6
		MM	457	462,3	615	36 (38)	565	20	M24	26	35,6
500	10	ISO	508	513,5	670	38	620	20	M24	26	41,1
		MM	506	513,5	670	38	620	20	M24	26	41,1
600	10	ISO	610	616,5	780	42 (40)	725	20	M27	30	52,87
		MM	610	616,5	780	42 (40)	725	20	M27	30	52,87
700	10	ISO	711	716	895	50 (40)	840	24	M27	30	66,48
		MM	711	716	895	50 (40)	840	24	M27	30	66,48
800	10	ISO	813	818	1015	56 (44)	950	24	M30	33	91,82
		MM	813	818	1015	56 (44)	950	24	M30	33	91,82
900	10	ISO	914	920	1115	62 (48)	1050	28	M30	33	109,55
		MM	914	920	1115	62 (48)	1050	28	M30	33	109,55
1000	10	ISO	1016	1022	1230	70 (50)	1160	28	M33	36	134,61
		MM	1016	1022	1230	70 (50)	1160	28	M33	36	134,61

• Valores entre paréntesis pertenecen a la DIN 2576
Values in parentheses belong to DIN 2576

BRIDA PLANA PARA SOLDAR EN-1092-1 TIPO: 01A PN-16 PLATE FLANGE FOR WELDING EN-1092-1 TYPE: 01A PN-16
BRIDA FORJADA DE ACERO INOXIDABLE STAINLESS STEEL FORGET FLANGE

01A PN16 MM A304L

Brida forjada plana para soldar
Material: acero inoxidable EN 1.4307 / A304L
Tubo milimétrico

Plate flange for welding EN-1092-1 Type: 01A
Material: stainless steel EN 1.4307 / A304L
Milimetric pipe



CÓDIGO CODE	DN	PN
01A61014015	15	10-16-25-40
01A61014020	20	10-16-25-40
01A61014025	25	10-16-25-40
01A61014032	32	10-16-25-40
01A61014040	40	10-16-25-40
01A61014050	50	10-16
01A61014065	65	10-16
01A61014080	80	10-16
01A61014100	100	10-16
01A61014125	125	10-16
01A61014150	150	10-16
01A16014200	200	16
01A16014250	250	16
01A16014300	300	16
01A16004350	350	16
01A16004400	400	16
01A16004500	500	16
01A16004600	600	16
01A16004700	700	16
01A16004800	800	16

01A PN16 MM A316L

Brida forjada plana para soldar
Material: acero inoxidable EN 1.4404 / A316L
Tubo milimétrico

Plate flange for welding EN-1092-1 Type: 01A
Material: stainless steel EN 1.4404 / A316L
Milimetric pipe



CÓDIGO CODE	DN	PN
01A61016015	15	10-16-25-40
01A61016020	20	10-16-25-40
01A61016025	25	10-16-25-40
01A61016032	32	10-16-25-40
01A61016040	40	10-16-25-40
01A61016050	50	10-16
01A61016065	65	10-16
01A61016080	80	10-16
01A61016100	100	10-16
01A61016125	125	10-16
01A61016150	150	10-16
01A16016200	200	16
01A16016250	250	16
01A16016300	300	16
01A16006350	350	16
01A16006400	400	16
01A16006500	500	16
01A16006600	600	16
01A16006700	700	16
01A16006800	800	16

01A PN16 ISO A304L

Brida forjada plana para soldar
Material: acero inoxidable EN 1.4307 / A304L
Tubo ISO

Plate flange for welding EN-1092-1 Type: 01A
Material: stainless steel EN 1.4307 / A304L
ISO pipe



CÓDIGO CODE	DN	PN
01A61024015	15	10-16-25-40
01A61024020	20	10-16-25-40
01A61024025	25	10-16-25-40
01A61024032	32	10-16-25-40
01A61024040	40	10-16-25-40
01A61024050	50	10-16
01A61024065	65	10-16
01A61024080	80	10-16
01A61024100	100	10-16
01A61024125	125	10-16
01A61024150	150	10-16
01A16024200	200	16
01A16024250	250	16
01A16024300	300	16
01A16004350	350	16
01A16004400	400	16
01A16004500	500	16
01A16004600	600	16
01A16004700	700	16
01A16004800	800	16

01A PN16 ISO A316L

Brida forjada plana para soldar
Material: acero inoxidable EN 1.4404 / A316L
Tubo ISO

Plate flange for welding EN-1092-1 Type: 01A
Material: stainless steel EN 1.4404 / A316L
ISO pipe



CÓDIGO CODE	DN	PN
01A61026015	15	10-16-25-40
01A61026020	20	10-16-25-40
01A61026025	25	10-16-25-40
01A61026032	32	10-16-25-40
01A61026040	40	10-16-25-40
01A61026050	50	10-16
01A61026065	65	10-16
01A61026080	80	10-16
01A61026100	100	10-16
01A61026125	125	10-16
01A61026150	150	10-16
01A16026200	200	16
01A16026250	250	16
01A16026300	300	16
01A16006350	350	16
01A16006400	400	16
01A16006500	500	16
01A16006600	600	16
01A16006700	700	16
01A16006800	800	16

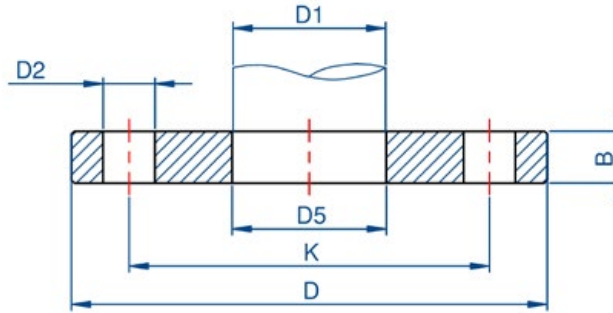

DN	PN	TUBO PIPE			BRIDA FLANGE			TORNILLOS BOLTS			PESO WEIGHT HT (7,85kg/m3)
		TIPO TYPE	D1	D5	D	B	K	nº ROSCA THREAD	D2		
15	10-16-25-40	ISO	21,3	22	95	14	65	4	M12	14	0,67
		MM	18	18,5	95	14	65	4	M12	14	0,69
20	10-16-25-40	ISO	26,9	27,5	105	16	75	4	M12	14	0,94
		MM	23	23,5	105	16	75	4	M12	14	0,97
25	10-16-25-40	ISO	33,7	34,5	115	16	85	4	M12	14	1,11
		MM	28	28,5	115	16	85	4	M12	14	1,16
32	10-16-25-40	ISO	42,4	43,5	140	18 (16)	100	4	M16	18	1,62
		MM	38	38,5	140	18 (16)	100	4	M16	18	1,68
40	10-16-25-40	ISO	48,3	49,5	150	18 (16)	110	4	M16	18	1,86
		MM	43	43,5	150	18 (16)	110	4	M16	18	1,92
50	10-16	ISO	60,3	61,5	165	20 (18)	125	4	M16	18	2,47
		MM	53	53,5	165	20 (18)	125	4	M16	18	2,59
65	10-16	ISO	76,1	77,5	185	20 (18)	145	8 (4)	M16	18	3
		MM	73	73,7	185	20 (18)	145	8 (4)	M16	18	3,08
80	10-16	ISO	88,9	90,5	200	20	160	8	M16	18	3,79
		MM	84	84,7	200	20	160	8	M16	18	3,77
100	10-16	ISO	114,3	116	220	22 (20)	180	8	M16	18	4,03
		MM	104	104,8	220	22 (20)	180	8	M16	18	4,34
125	10-16	ISO	139,7	141,5	250	22	210	8	M16	18	5,46
		MM	129	130	250	22	210	8	M16	18	5,89
150	10-16	ISO	168,3	170,5	285	24 (22)	240	8	M20	22	6,57
		MM	154	156	285	24 (22)	240	8	M20	22	7,27
200	16	ISO	219,1	221,5	340	26 (24)	295	12	M20	22	9,2
		MM	204	206	340	26 (24)	295	12	M20	22	10,07
250	16	ISO	273	276,5	405	29 (26)	355	12	M24	26	13,4
		MM	254	256	405	29 (26)	355	12	M24	26	14,64
300	16	ISO	323,9	327,5	460	32 (28)	410	12	M24	26	17,4
		MM	304	307	460	32 (28)	410	12	M24	26	19,06
350	16	ISO	355,6	359,5	520	35 (30)	470	16	M24	26	28,6
		MM	354	359,5	520	35 (30)	470	16	M24	26	28,6
400	16	ISO	406,4	411	580	38 (32)	525	16	M27	30	30,9
		MM	406	411	580	38 (32)	525	16	M27	30	30,9
500	16	ISO	508	513,5	715	46 (38)	650	20	M30	33	54
		MM	508	513,5	715	46 (38)	650	20	M30	33	54
600	16	ISO	610	616,5	840	55	770	20	M33	36	102
		MM	610	616,5	840	55	770	20	M33	36	102
700	16	ISO	711	716	910	63	840	24	M33	36	111
		MM	711	716	910	63	840	24	M33	36	111
800	16	ISO	813	818	1025	74	950	24	M36	39	158
		MM	813	818	1025	74	950	24	M36	39	158

- Valores entre paréntesis pertenecen a la DIN 2502
Values in parentheses belong to DIN 2502

BRIDA PLANA PARA SOLDAR EN-1092-1 TIPO: 01A PN-25 PLATE FLANGE FOR WELDING EN-1092-1 TYPE: 01A PN-25
BRIDA FORJADA DE ACERO INOXIDABLE STAINLESS STEEL FORGET FLANGE

01A PN25 ISO A304L

Brida forjada plana para soldar
Material: acero inoxidable EN 1.4307 / A304L
Tubo ISO

Plate flange for welding EN-1092-1 Type: 01A
Material: stainless steel EN 1.4307 / A304L
ISO pipe



CÓDIGO CODE	DN	PN
01A61024015	15	10-16-25-40
01A61024020	20	10-16-25-40
01A61024025	25	10-16-25-40
01A61024032	32	10-16-25-40
01A61024040	40	10-16-25-40
01A40024050	50	25-40
01A40024065	65	25-40
01A40024080	80	25-40
01A40024100	100	25-40
01A40024125	125	25-40
01A40024150	150	25-40
01A25024200	200	25
01A25024250	250	25
01A25024300	300	25

01A PN25 ISO A316L

Brida forjada plana para soldar
Material: acero inoxidable EN 1.4404 / A316L
Tubo ISO

Plate flange for welding EN-1092-1 Type: 01A
Material: stainless steel EN 1.4404 / A316L
ISO pipe



CÓDIGO CODE	DN	PN
01A61026015	15	10-16-25-40
01A61026020	20	10-16-25-40
01A61026025	25	10-16-25-40
01A61026032	32	10-16-25-40
01A61026040	40	10-16-25-40
01A40026050	50	25-40
01A40026065	65	25-40
01A40026080	80	25-40
01A40026100	100	25-40
01A40026125	125	25-40
01A40026150	150	25-40
01A25026200	200	25
01A25026250	250	25
01A25026300	300	25

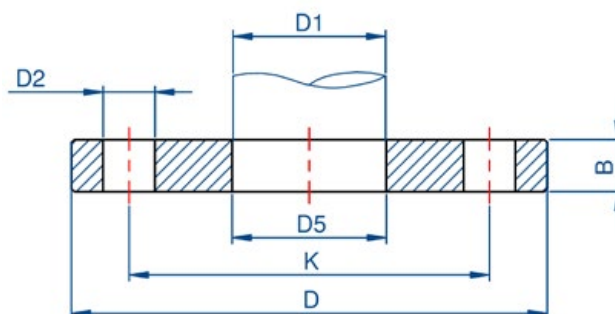

DN	PN	TUBO PIPE			BRIDA FLANGE			TORNILLOS BOLTS			PESO WEIGHT HT (7,85kg/m3)
		TIPO TYPE	D1	D5	D	B	K	n°	ROSCA THREAD	D2	
15	10-16-25-40	ISO	21,3	22	95	14	65	4	M12	14	0,67
20	10-16-25-40	ISO	26,9	27,5	105	16	75	4	M12	14	0,94
25	10-16-25-40	ISO	33,7	34,5	115	16	85	4	M12	14	1,11
32	10-16-25-40	ISO	42,4	43,5	140	18	100	4	M16	18	1,82
40	10-16-25-40	ISO	48,3	49,5	150	18	110	4	M16	18	2,08
50	25-40	ISO	60,3	61,5	165	20	125	4	M16	18	2,73
65	25-40	ISO	76,1	77,5	185	22	145	8	M16	18	3,45
80	25-40	ISO	88,9	90,5	200	24	160	8	M16	18	4,32
100	25-40	ISO	114,3	116	235	26	190	8	M20	22	6,07
125	25-40	ISO	139,7	141,5	270	28	220	8	M24	26	8,19
150	25-40	ISO	168,3	170,5	300	30	250	8	M24	26	10,3
200	25	ISO	219,1	221,5	360	32	315	12	M24	26	14,3
250	25	ISO	273	276,5	425	35	370	12	M27	30	20,1
300	25	ISO	323,9	327,5	485	38	430	16	M27	30	26,6

BRIDA PLANA PARA SOLDAR EN-1092-1 TIPO: 01A PN-40 PLATE FLANGE FOR WELDING EN-1092-1 TYPE: 01A PN-40
BRIDA FORJADA DE ACERO INOXIDABLE STAINLESS STEEL FORGET FLANGE

01A PN40 ISO A304L

Brida forjada plana para soldar
Material: acero inoxidable EN 1.4307 / A304L
Tubo ISO

Plate flange for welding EN-1092-1 Type: 01A
Material: stainless steel EN 1.4307 / A304L
ISO pipe

NEW



CÓDIGO CODE	DN	PN
01A61024015	15	10-16-25-40
01A61024020	20	10-16-25-40
01A61024025	25	10-16-25-40
01A61024032	32	10-16-25-40
01A61024040	40	10-16-25-40
01A40024050	50	25-40
01A40024065	65	25-40
01A40024080	80	25-40
01A40024100	100	25-40
01A40024125	125	25-40
01A40024150	150	25-40
01A40024200	200	40
01A40024250	250	40
01A40024300	300	40

01A PN40 ISO A316L

Brida forjada plana para soldar
Material: acero inoxidable EN 1.4404 / A316L
Tubo ISO

Plate flange for welding EN-1092-1 Type: 01A
Material: stainless steel EN 1.4404 / A316L
ISO pipe

NEW



CÓDIGO CODE	DN	PN
01A61026015	15	10-16-25-40
01A61026020	20	10-16-25-40
01A61026025	25	10-16-25-40
01A61026032	32	10-16-25-40
01A61026040	40	10-16-25-40
01A40026050	50	25-40
01A40026065	65	25-40
01A40026080	80	25-40
01A40026100	100	25-40
01A40026125	125	25-40
01A40026150	150	25-40
01A40026200	200	40
01A40026250	250	40
01A40026300	300	40
05A16046450	450	16

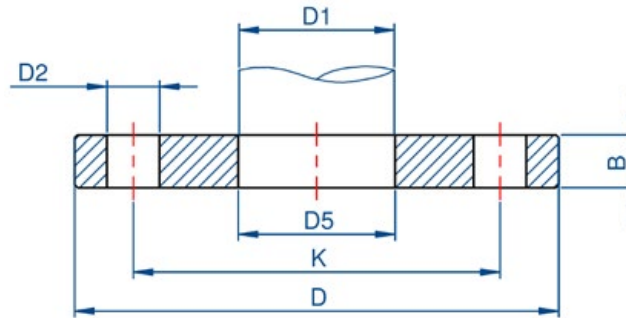

DN	PN	TIPO TYPE	TUBO PIPE		BRIDA FLANGE			TORNILLOS BOLTS			PESO WEIGHT HT (7,85kg/m3)
			D1	D5	D	B	K	nº	ROSCA THREAD	D2	
15	10-16-25-40	ISO	21,3	22	95	14	65	4	M12	14	0,67
20	10-16-25-40	ISO	26,9	27,5	105	16	75	4	M12	14	0,94
25	10-16-25-40	ISO	33,7	34,5	115	16	85	4	M12	14	1,11
32	10-16-25-40	ISO	42,4	43,5	140	18	100	4	M16	18	1,82
40	10-16-25-40	ISO	48,3	49,5	150	18	110	4	M16	18	2,08
50	25-40	ISO	60,3	61,5	165	20	125	4	M16	18	2,73
65	25-40	ISO	76,1	77,5	185	22	145	8	M16	18	3,45
80	25-40	ISO	88,9	90,5	200	24	160	8	M16	18	4,32
100	25-40	ISO	114,3	116	235	26	190	8	M20	22	6,07
125	25-40	ISO	139,7	141,5	270	28	220	8	M24	26	8,19
150	25-40	ISO	168,3	170,5	300	30	250	8	M24	26	10,3
200	40	ISO	219,1	221,5	360	36	320	12	M27	30	17,9
250	40	ISO	273	276,5	425	42	385	12	M30	33	29,3
300	40	ISO	323,9	327,5	485	52	450	16	M30	33	45,1

BRIDA ROSCADA EN-1092-1 TIPO: 13B PN-16 THREADED PLATE FLANGE EN-1092-1 TYPE: 013B PN-16
BRIDA FORJADA DE ACERO INOXIDABLE STAINLESS STEEL FORGED FLANGE

13B PN16 BSP A304L

Brida roscada
Material: acero inoxidable
EN 1.4307 / A304L

Threaded flange EN-1092-1 Type: 013B
Material: stainless steel
EN 1.4404 / A304L



CÓDIGO CODE	DN	PN	ROSCA THREAD
13B61054015	15	10-16-25-40	1/2"
13B61054020	20	10-16-25-40	3/4"
13B61054025	25	10-16-25-40	1"
13B61054032	32	10-16-25-40	1 1/4"
13B61054040	40	10-16-25-40	1 1/2"
13B61054050	50	10-16	2"
13B61054065	65	10-16	2 1/2"
13B61054080	80	10-16	3"
13B61054100	100	10-16	4"

13B PN16 BSP A316L

Brida roscada
Material: acero inoxidable
EN 1.4404 / A316L

Threaded flange EN-1092-1 Type: 013B
Material: stainless steel
EN 1.4404 / A316L



CÓDIGO CODE	DN	PN	ROSCA THREAD
13B61056015	15	10-16-25-40	1/2"
13B61056020	20	10-16-25-40	3/4"
13B61056025	25	10-16-25-40	1"
13B61056032	32	10-16-25-40	1 1/4"
13B61056040	40	10-16-25-40	1 1/2"
13B61056050	50	10-16	2"
13B61056065	65	10-16	2 1/2"
13B61056080	80	10-16	3"
13B61056100	100	10-16	4"

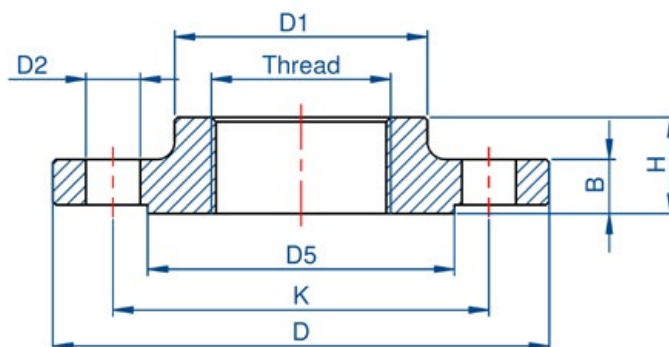

DN	PN	ROSCA THREAD	BRIDA FLANGE						TORNILLOS BOLTS			PESO WEIGHT HT (7,85kg/m ³)
			D	D5	H	K	D1	B	n°	ROSCA THREAD	D2	
15	10-16-25-40	1/2"	95	45	22	65	35	16	4	M12	14	0,72
20	10-16-25-40	3/4"	105	58	26	75	45	18	4	M12	14	1,04
25	10-16-25-40	1"	115	68	28	85	52	18	4	M12	14	1,25
32	10-16-25-40	1 1/4"	140	78	30	100	60	18	4	M16	18	1,81
40	10-16-25-40	1 1/2"	150	88	32	110	70	18	4	M16	18	2,06
50	10-16	2"	165	102	28	125	84	18	4	M16	18	2,39
65	10-16	2 1/2"	185	122	32	145	104	18	8 (4)	M16	18	2,97
80	10-16	3"	200	138	34	160	118	20	8	M16	18	3,78
100	10-16	4"	220	158	40	180	140	20	8	M16	18	4,38

BRIDA CIEGA EN-1092-1 TIPO: 05A PN-10 BLIND FLANGE EN-1092-1 TYPE: 05A PN-10
BRIDA FORJADA DE ACERO INOXIDABLE STAINLESS STEEL FORGED FLANGE

05A PN10 A304L

Brida ciega
Material: acero inoxidable EN 1.4307 / A304L
Blind flange EN-1092-1 Type: 05A
Material: stainless steel EN 1.4307 / A304L



CÓDIGO CODE	DN	PN
05A61044015	15	10-16-25-40
05A61044020	20	10-16-25-40
05A61044025	25	10-16-25-40
05A61044032	32	10-16-25-40
05A61044040	40	10-16-25-40
05A61044050	50	10-16
05A61044065	65	10-16
05A61044080	80	10-16
05A61044100	100	10-16
05A61044125	125	10-16
05A61044150	150	10-16
05A10044200	200	10
05A10044250	250	10
05A10044300	300	10
05A10044350	350	10
05A10044400	400	10
05A10044450	450	10
05A10044500	500	10
05A10044600	600	10

05A PN10 A316L

Brida ciega
Material: acero inoxidable EN 1.4404 / A316L
Blind flange EN-1092-1 Type: 05A
Material: stainless steel EN 1.4404 / A316L



CÓDIGO CODE	DN	PN
05A61046015	15	10-16-25-40
05A61046020	20	10-16-25-40
05A61046025	25	10-16-25-40
05A61046032	32	10-16-25-40
05A61046040	40	10-16-25-40
05A61046050	50	10-16
05A61046065	65	10-16
05A61046080	80	10-16
05A61046100	100	10-16
05A61046125	125	10-16
05A61046150	150	10-16
05A10046200	200	10
05A10046250	250	10
05A10046300	300	10
05A10046350	350	10
05A10046400	400	10
05A10046450	450	10
05A10046500	500	10
05A10046600	600	10

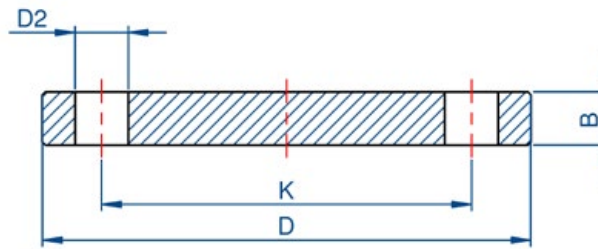

DN	PN	BRIDA FLANGE			TORNILLOS BOLTS			PESO WEIGHT HT (7,85kg/m3)
		D	B	ØK	nº	ROSCA THREAD	D2	
15	10-16-25-40	95	16 (14)	65	4	M12	14	0,72
20	10-16-25-40	105	18 (16)	75	4	M12	14	1,01
25	10-16-25-40	115	18 (16)	85	4	M12	14	1,23
32	10-16-25-40	140	18 (16)	100	4	M16	18	1,8
40	10-16-25-40	150	18 (16)	110	4	M16	18	2,09
50	10-16	165	18	125	4	M16	18	2,88
65	10-16	185	18	145	8	M16	18	3,66
80	10-16	200	20	160	8	M16	18	4,77
100	10-16	220	20	180	8	M16	18	5,65
125	10-16	250	22	210	8	M16	18	8,42
150	10-16	285	22	240	8	M20	22	10,4
200	10	340	24	295	8	M20	22	16,5
250	10	395	26	350	12	M20	22	24
300	10	445	26	400	12	M20	22	30,9
350	10	505	26	460	16	M20	22	40,6
400	10	565	26	515	16	M24	26	49,4
450	10	615	28	565	20	M24	26	63
500	10	670	28	620	20	M24	26	75
600	10	780	34 (30)	725	20	M27	30	110,35

• Valores entre paréntesis pertenecen a la DIN 2527
Values in parentheses belong to DIN 2527

BRIDA CIEGA EN-1092-1 TIPO: 05A PN-16 BLIND FLANGE EN-1092-1 TYPE: 05A PN-16
BRIDA FORJADA DE ACERO INOXIDABLE STAINLESS STEEL FORGED FLANGE

05A PN16 A316L

Brida ciega

Material: acero inoxidable EN 1.4404 / A316L

Blind flange EN-1092-1 Type: 05A

Material: stainless steel EN 1.4404 / A316L

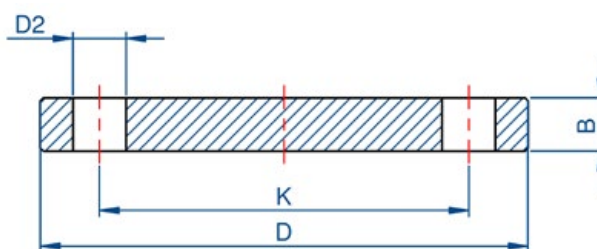

CÓDIGO CODE	DN	PN
05A16046200	200	16
05A16046250	250	16
05A16046300	300	16
05A16046350	350	16
05A16046400	400	16
05A16046450	450	16
05A16046500	500	16
05A16046600	600	16
05A16046700	700	16
05A16046800	800	16

DN	PN	BRIDA FLANGE			n°	TORNILLOS BOLTS		PESO WEIGHT HT (7,85kg/m ³)
		D	b	k		ROSCA THREAD	D2	
200	16	340	24	295	12	M20	22	16,2
250	16	405	26	355	12	M24	26	25
300	16	460	28	410	12	M24	26	35,1
350	16	520	30	470	16	M24	26	48
400	16	580	32	525	16	M27	30	63,5
450	16	640	42	585	20	M27	30	96,6
500	16	715	44 (36)	650	20	M30	33	133
600	16	840	54	770	20	M33	36	226
700	16	910	58	840	24	M33	36	285
800	16	1025	62	950	24	M33	39	388

- Valores entre paréntesis pertenecen a la DIN 2527
Values in parentheses belong to DIN 2527

BRIDA CON CUELLO EN-1092-1 TIPO: 11B PN-16 WELDING NECK FLANGE EN-1092-1 TYPE: 11B PN-16
BRIDA FORJADA DE ACERO INOXIDABLE STAINLESS STEEL FORGED FLANGE

11B PN16 A304L

Brida con cuello
Material: acero inoxidable EN 1.4307 / A304L
Welding neck flange EN-1092-1 Type: 11B
Material: stainless steel EN 1.4307 / A304L



CÓDIGO CODE	DN	PN
11B161024015	15	10-16-25-40
11B161024020	20	10-16-25-40
11B161024025	25	10-16-25-40
11B161024032	32	10-16-25-40
11B161024040	40	10-16-25-40
11B161024050	50	10-16
11B161024065	65	10-16
11B161024080	80	10-16
11B161024100	100	10-16
11B161024125	125	10-16
11B161024150	150	10-16
11B116024200	200	16
11B116024250	250	16
11B116024300	300	16
11B116024350	350	16
11B116024400	400	16
11B116024500	500	16

- Para tubo ISO
ISO pipes

11B PN16 A316L

Brida con cuello
Material: acero inoxidable EN 1.4404 / A316L
Welding neck flange EN-1092-1 Type: 11B
Material: stainless steel EN 1.4404 / A316L



CÓDIGO CODE	DN	PN
11B161026015	15	10-16-25-40
11B161026020	20	10-16-25-40
11B161026025	25	10-16-25-40
11B161026032	32	10-16-25-40
11B161026040	40	10-16-25-40
11B161026050	50	10-16
11B161026065	65	10-16
11B161026080	80	10-16
11B161026100	100	10-16
11B161026125	125	10-16
11B161026150	150	10-16
11B116026200	200	16
11B116026250	250	16
11B116026300	300	16
11B116026350	350	16
11B116026400	400	16
11B116026500	500	16

- Para tubo ISO
ISO pipes

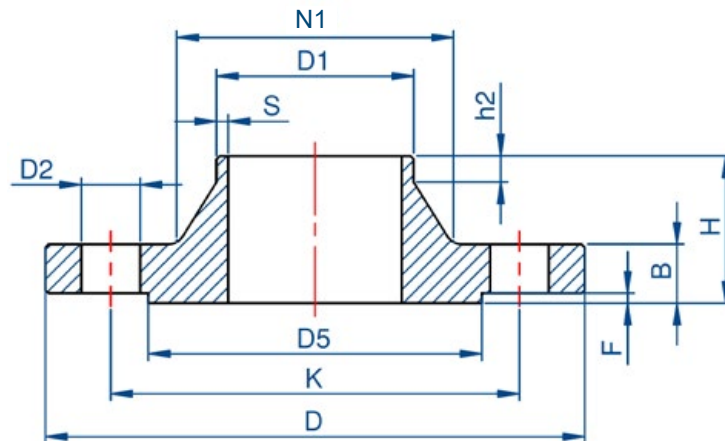

DN	PN	BRIDA FLANGE											TORNILLOS BOLTS		PESO WEIGHT
		D1	D3	D	B	K	H	S	h2	D5	F	n°	ROSCA THREAD	D2	HT (7,85kg/m3)
15	10-16-25-40	21,3	32	95	16	65	38	2	6	45	2	4	M12	14	0,77
20	10-16-25-40	26,9	40	105	18	75	40	2,3	6	58	2	4	M12	14	1,09
25	10-16-25-40	33,7	46	115	18	85	40	2,6	6	68	2	4	M12	14	1,3
32	10-16-25-40	42,4	56	140	18	100	42	2,6	6	78	2	4	M16	18	1,91
40	10-16-25-40	48,3	64	150	18	110	45	2,6	7	88	3	4	M16	18	2,15
50	10-16	60,3	74	165	18	125	45	2,9	8	102	3	4	M16	18	2,53
65	10-16	76,1	92	185	18	145	45	2,9	10	122	3	8 (4)	M16	18	3,03
80	10-16	88,9	105	200	20	160	50	3,2	10	138	3	8	M16	18	3,92
100	10-16	114,3	131	220	20	180	52	3,6	12	158	3	8	M16	18	4,62
125	10-16	139,7	156	250	22	210	55	4	12	188	3	8	M16	18	6,3
150	10-16	168,3	184	285	22	240	55	4,5	12	212	3	8	M20	22	7,81
200	16	219,1	235	340	24	295	62	6,3 (5,9)	16	268	3	12	M20	22	11,5
250	16	273	292	405	26	355	70	6,3	16	320	3	12	M24	26	16,7
300	16	323,9	344	460	28	410	78	7,1	16	378	4	12	M24	26	22,1
350	16	355,6	390	520	30	470	82	8	16	438	4	16	M24	26	32,8
400	16	406,4	445	580	32	525	85	8	16	490	4	16	M27	30	41,1
500	16	508	548	715	36	650	84	8	16	610	4	20	M30	33	66,2

- Valores entre paréntesis pertenecen a la DIN 2633
Values in parentheses belong to DIN 2633

BRIDA CON CUELLO EN-1092-1 TIPO: 11B PN-40 WELDING NECK FLANGE EN-1092-1 TYPE: 11B PN-40
BRIDA FORJADA DE ACERO INOXIDABLE STAINLESS STEEL FORGED FLANGE

11B PN40 A304L

Brida con cuello

Material: acero inoxidable EN 1.4307 / A304L

Welding neck flange EN-1092-1 Type: 11B

Material: stainless steel EN 1.4307 / A304L

NEW



CÓDIGO CODE	DN	PN
11B161024015	15	10-16-25-40
11B161024020	20	10-16-25-40
11B161024025	25	10-16-25-40
11B161024032	32	10-16-25-40
11B161024040	40	10-16-25-40
11B40024050	50	25-40
11B40024065	65	25-40
11B40024080	80	25-40
11B40024100	100	25-40
11B40024125	125	25-40
11B40024150	150	25-40
11B40024200	200	40
11B40024250	250	40
11B40024300	300	40

- Para tubo ISO
ISO pipes

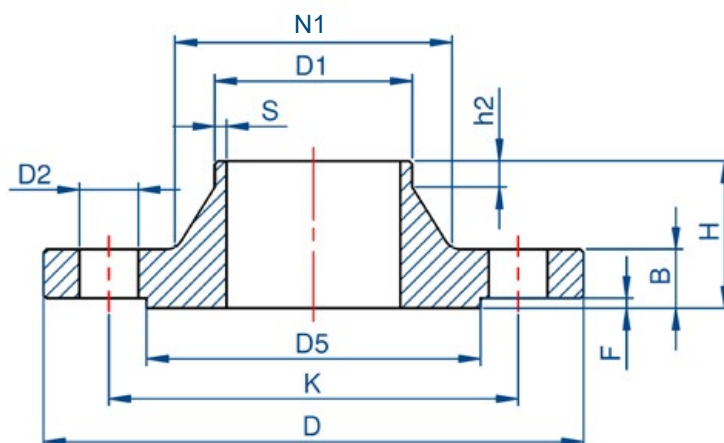

DN	PN	BRIDA FLANGE										TORNILLOS BOLTS			PESO WEIGHT HT (7,85kg/m3)
		D1	D3	D	B	K	H	S	h2	D5	F	n°	ROSCA THREAD	D2	
15	10-16-25-40	21,3	32	95	16	65	38	2	6	45	2	4	M12	14	0,77
20	10-16-25-40	26,9	40	105	18	75	40	2,3	6	58	2	4	M12	14	1,09
25	10-16-25-40	33,7	46	115	18	85	40	2,6	6	68	2	4	M12	14	1,3
32	10-16-25-40	42,4	56	140	18	100	42	2,6	6	78	2	4	M16	18	1,91
40	10-16-25-40	48,3	64	150	18	110	45	2,6	7	88	3	4	M16	18	2,15
50	25-40	60,3	75	165	18	125	48	2,9	8	102	3	4	M16	18	2,85
65	25-40	76,1	90	185	18	145	52	2,9	10	122	3	8	M16	18	3,68
80	25-40	88,9	105	200	20	160	58	3,2	10	138	3	8	M16	18	4,78
100	25-40	114,3	134	235	20	190	65	3,6	12	158	3	8	M20	22	6,46
125	25-40	139,7	162	270	22	220	68	4	12	188	3	8	M24	26	8,86
150	25-40	168,3	192	300	22	250	75	4,5	12	212	3	8	M24	26	11,7
200	40	219,1	244	375	24	320	88	6,3	16	268	3	12	M27	30	21
250	40	273	306	450	26	385	105	7,1	18	320	3	12	M30	33	34,2
300	40	323,9	362	515	28	450	115	8	18	378	4	16	M30	33	47,6

VALONA PARA BRIDA DIN/EN-1092 FOR DIN/EN-1092 FLANGE COLLARS
VALONA FORJADA DE ACERO INOXIDABLE STAINLESS STEEL FORGET SHORT NECK PRESSED

S525604

Valona ISO A-304L
Short neck pressed
collars ISO A-304L



CÓDIGO CODE	MEDIDA SIZE	☐	☐
S525604015	21.3/2	1	1
S525604020	26.9/2	1	1
S525604025	33.7/2	1	1
S525604032	42.4/2	1	1
S525604040	48.3/2	1	1
S525604050	60.3/2	1	1
S525604065	76.1/2	1	1
S525604080	88.9/2	1	1
S525604100	114.3/2	1	1
S525604125	139.7/2	1	1
S525604150	168.3/2	1	1
S525604200	219.1/2	1	1
S525604250	273.1/2	1	1
S525604300	323.9/2	1	1

S525606

Valona ISO A-316L
Short neck pressed
collars ISO A-316L



CÓDIGO CODE	MEDIDA SIZE	☐	☐
S525606015	21.3/2	1	1
S525606020	26.9/2	1	1
S525606025	33.7/2	1	1
S525606032	42.4/2	1	1
S525606040	48.3/2	1	1
S525606050	60.3/2	1	1
S525606065	76.1/2	1	1
S525606080	88.9/2	1	1
S525606100	114.3/2	1	1
S525606125	139.7/2	1	1
S525606150	168.3/2	1	1
S525606200	219.1/2	1	1
S525606250	273.1/2	1	1
S525606300	323.9/2	1	1

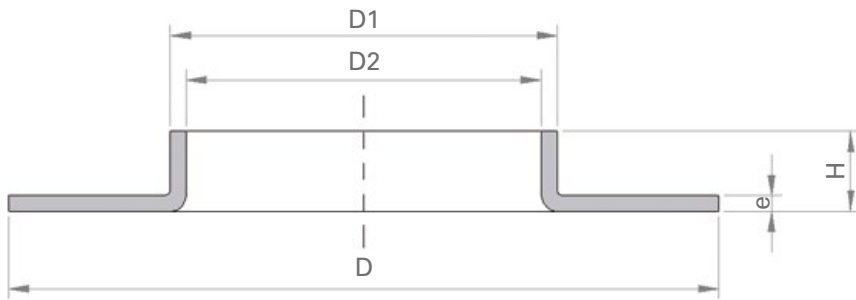

DN	DT	e	H	D	D1	D2
15	1/2"	2	6	43	21,3	17,3
20	3/4"	2	8	58	26,9	22,9
25	1"	2	9	68	33,7	29,7
32	1 1/4"	2	10	78	42,4	38,4
40	1 1/2"	2	10	88	48,3	44,3
50	2"	2	12	102	60,3	56,3
65	2 1/2"	2	12	122	76,1	72,1
80	3"	2	12	139	88,9	84,9
100	4"	2	16	158	114,3	110,3
125	5"	2	16	185	139,7	135,7
150	6"	2	17	212	168,3	164,3
200	8"	2	18	270	219,1	215,1
250	10"	2	18	323	273,0	269,0
300	12"	2	19	372	323,9	319,9

BRIDAS ANSI ANSI FLANGES

SO1506 ANSI 150
EN 1.4404/A-316L

Brida Slip-On A-316L
Slip On flange A-316L



CÓDIGO CODE	DN	PSI
SO1506-015	1/2"	150
SO1506-020	3/4"	150
SO1506-025	1"	150
SO1506-032	1 1/4"	150
SO1506-040	1 1/2"	150
SO1506-050	2"	150
SO1506-065	2 1/2"	150
SO1506-080	3"	150
SO1506-100	4"	150
SO1506-125	5"	150
SO1506-150	6"	150
SO1506-200	8"	150
SO1506-250	10"	150

WN1506 ANSI 150
EN 1.4404/A-316L

Brida welding neck A-316L
Welding neck flange A-316L



CÓDIGO CODE	DN	PSI
WN1506-015	1/2"	150
WN1506-020	3/4"	150
WN1506-025	1"	150
WN1506-032	1 1/4"	150
WN1506-040	1 1/2"	150
WN1506-050	2"	150
WN1506-065	2 1/2"	150
WN1506-080	3"	150
WN1506-100	4"	150
WN1506-125	5"	150
WN1506-150	6"	150
WN1506-200	8"	150
WN1506-250	10"	150

BL1506 ANSI 150
EN 1.4404/A-316L

Brida ciega A-316L
Blind flange A-316L



CÓDIGO CODE	DN	PSI
BL1506-015	1/2"	150
BL1506-020	3/4"	150
BL1506-025	1"	150
BL1506-032	1 1/4"	150
BL1506-040	1 1/2"	150
BL1506-050	2"	150
BL1506-065	2 1/2"	150
BL1506-080	3"	150
BL1506-100	4"	150
BL1506-125	5"	150
BL1506-150	6"	150
BL1506-200	8"	150
BL1506-250	10"	150

LJ1506 ANSI 150
EN 1.4404/A-316L

Brida Lap Joint A-316L
Lap Joint Flange A-316L



CÓDIGO CODE	DN	PSI
LJ1506-015	1/2"	150
LJ1506-020	3/4"	150
LJ1506-025	1"	150
LJ1506-032	1 1/4"	150
LJ1506-040	1 1/2"	150
LJ1506-050	2"	150
LJ1506-065	2 1/2"	150
LJ1506-080	3"	150
LJ1506-100	4"	150
LJ1506-125	5"	150
LJ1506-150	6"	150
LJ1506-200	8"	150
LJ1506-250	10"	150

SW1506 ANSI 150
EN 1.4404/A-316L

Brida socket welding
A-316L
Socket Welding flange
A-316L



CÓDIGO CODE	DN	PSI
SW1506-015	1/2"	150
SW1506-020	3/4"	150
SW1506-025	1"	150
SW1506-032	1 1/4"	150
SW1506-040	1 1/2"	150
SW1506-050	2"	150
SW1506-065	2 1/2"	150
SW1506-080	3"	150
SW1506-100	4"	150
SW1506-125	5"	150
SW1506-150	6"	150
SW1506-200	8"	150
SW1506-250	10"	150

FICHA TÉCNICA BRIDA ANSI 150 B 16.5 TECHNICAL DATA SHEET ANSI FLANGE 150 B 16.5

BRIDA FLANGE
ANSI BL

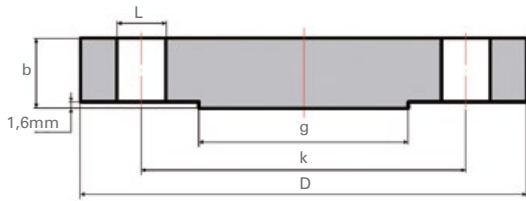

BRIDA FLANGE
ANSI LJ

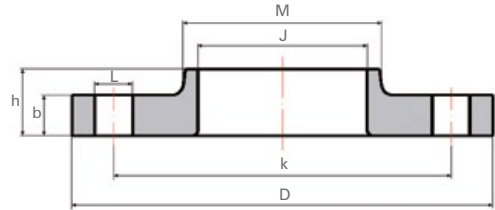

BRIDA FLANGE
ANSI SO

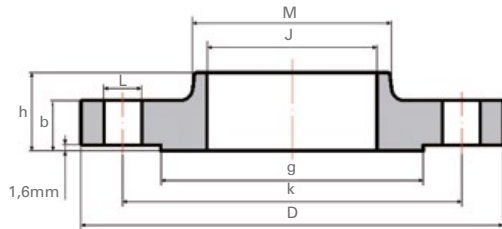

BRIDA FLANGE
ANSI SW

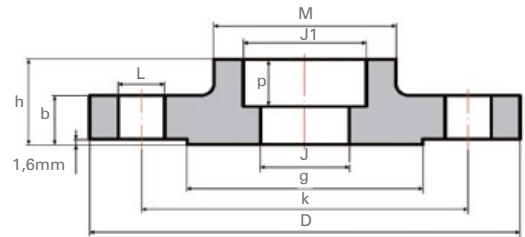

BRIDA FLANGE
ANSI WN

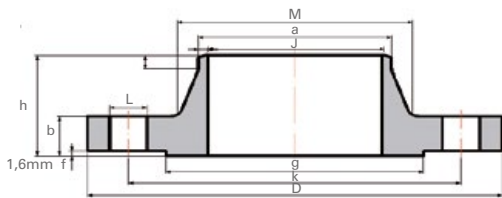

DN	D	BRIDA FLANGE				TORNILLOS BOLTS		
		b	M	g	k	N	ROSCA THREAD	L
1/2	90	11,2	30,2	35,1	60,5	4	1/2	15,7
3/4	100	12,7	38,1	42,9	69,9	4	1/2	15,7
1	110	14,2	49,3	50,8	79,2	4	1/2	15,7
1 1/4	118	15,7	58,7	63,5	88,9	4	1/2	15,7
1 1/2	125	17,5	65	73,2	98,6	4	1/2	15,7
2	150	19,1	77,7	91,9	120,7	4	5/8	19,1
2 1/2	180	22,4	90,4	104,6	139,7	4	5/8	19,1
3	190	23,9	108	127	152,4	4	5/8	19,1
4	230	23,9	134,9	157,2	190,5	8	5/8	19,1
5	254	23,9	163,6	185,7	215,9	8	3/4	22,4
6	280	25,4	192	215,9	241,3	8	3/4	22,4
8	345	28,4	246,1	269,7	298,5	8	3/3	22,4
10	405	30,2	304,8	323,8	361,9	12	7/8	25,4

DN	BLIND	LAP JOINT			SLIP ON			SOCKET WELDING				WELDING NECK				
	Kg	J	h	Kg	J	h	Kg	J	J1	p	h	Kg	J	h	a	Kg
1/2	0,4	22,9	15,7	0,4	22,4	15,7	0,4	22,4	15,7	9,6	15,7	0,4	15,7	47,8	21,3	0,5
3/4	0,7	28,2	15,7	0,7	27,7	15,7	0,7	27,7	20,8	11,1	15,7	0,7	20,8	52,3	26,7	0,7
1	0,9	35,1	17,5	0,8	34,5	17,5	0,8	34,5	26,7	12,7	17,5	0,9	26,7	55,6	33,5	1,1
1 1/4	1,3	43,7	20,6	1,1	43,2	20,6	1,1	43,2	35,1	14,2	20,6	1,2	35,1	57,2	42,2	1,5
1 1/2	1,6	50	22,4	1,4	49,5	22,4	1,4	49,5	40,9	15,7	22,4	1,5	40,9	62	48,3	1,8
2	2,6	62,5	25,4	2,2	62	25,4	2,2	62	52,6	17,5	25,4	2,3	52,6	63,5	60,5	2,7
2 1/2	4,1	75,4	28,4	3,6	74,7	28,4	3,6	74,7	62,7	19	28,4	3,7	62,7	69,9	73,2	4,4
3	5	91,4	30,2	4,1	90,7	30,2	4,1	90,7	78	20,6	30,2	4,2	78	69,9	88,9	5,2
4	7,1	116,8	33,3	5,6	116,1	33,3	5,6	116,1	102,4	23,9	33,3	5,8	102,4	76,2	114,3	7,5
5	9	144,5	36,6	6,3	143,8	36,6	6,3	143,8	128,3	23,9	36,6	6,5	128,3	88,9	141,2	9,2
6	11,8	171,5	39,6	7,5	170,7	39,6	7,5	170,7	154,2	26,9	39,6	7,8	154,2	88,9	168,4	11
8	21	222,3	44,5	12,6	221,5	44,5	12,6	221,5	202,7	31,8	44,5	13,1	202,7	101,6	219,2	18,3
10	31,8	277,4	49,9	19,5	276,3	49,9	19,5	276,4	254,5	33,3	49,9	20,1	254,4	101,6	273	23

BRIDA PRENSADA **2642** PRESSED FLANGED **2642**
VALONA FORJADA DE ACERO INOXIDABLE STAINLESS STEEL FORGET SHORT NECK PRESSED

2642024 ISO A-304L

Brida prensada DIN-2642
ISO A-304L

Pressed flanged din 2642
ISO A-304L



CÓDIGO CODE	MEDIDA SIZE	☐	☐
2642024015	1/2"	1	1
2642024020	3/4"	1	1
2642024025	1"	1	1
2642024032	1 1/4"	1	1
2642024040	1 1/2"	1	1
2642024050	2"	1	1
2642024065	2 1/2"	1	1
2642024080	3"	1	1
2642024100	4"	1	1
2642024125	5"	1	1
2642024150	6"	1	1
2642024200	8"	1	1
2642024250	10"	1	1
2642024300	12"	1	1

2642026 ISO A-316L

Brida prensada DIN-2642
ISO A-316L

Pressed flanged din 2642
ISO A-316L



CÓDIGO CODE	MEDIDA SIZE	☐	☐
2642026015	1/2"	1	1
2642026020	3/4"	1	1
2642026025	1"	1	1
2642026032	1 1/4"	1	1
2642026040	1 1/2"	1	1
2642026050	2"	1	1
2642026065	2 1/2"	1	1
2642026080	3"	1	1
2642026100	4"	1	1
2642026125	5"	1	1
2642026150	6"	1	1
2642026200	8"	1	1
2642026250	10"	1	1
2642026300	12"	1	1

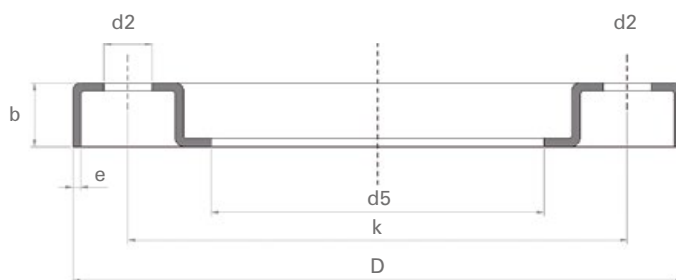

DN	MEDIDA SIZE	PN	TUBO PIPE	d5	D	b	k	e	N	ROSCA THREAD	d2	PESO WEIGHT
15	1/2"	10-16	21,3	25	95	11,5	65	3	4	M12	13,5	0,19
20	3/4"	10-16	26,9	31	105	14	75	3	4	M12	13,5	0,26
25	1"	10-16	33,7	38	115	16	85	3	4	M12	13,5	0,32
32	1 1/4"	10-16	42,4	47	140	16,5	100	3	4	M16	17,5	0,46
40	1 1/2"	10-16	48,3	53	150	17,5	110	3	4	M16	17,5	0,49
50	2"	10-16	60,3	66	165	19,5	125	3	4	M16	17,5	0,60
65	2 1/2"	10-16	76,1	82	185	21	145	3	4	M16	17,5	0,76
80	3"	10-16	88,9	95	200	22	160	3	8	M16	17,5	0,81
100	4"	10-16	114,3	120	220	23	180	4	8	M16	17,5	1,19
125	5"	10-16	139,7	146	250	25	210	4	8	M16	17,5	1,47
150	6"	10-16	168,3	175	295	27	240	5	8	M20	21,5	2,35
200	8"	10	219,1	227	340	31	295	6	8	M20	21,5	3,60
250	10"	10	273	281	395	34	350	6	8	M20	21,5	4,58
300	12"	10	323,9	331	445	38	400	6	8	M20	21,5	5,59

2

ACCESORIOS Y BRIDAS

FITTINGS AND FLANGES

Presión máxima de trabajo en Bar
Maximum working pressure Bar



25

Rango de temperatura °C
Temperature range °C



-20°
300°

2.3

HIERRO MALEABLE GALVANIZADO

MALLEABLE GALVANIZED IRON

Aplicaciones

Para agua fría y caliente,
aceite, aire, gas y vapor.

Applications

For hot and cold water,
oil, air, gas and steam.

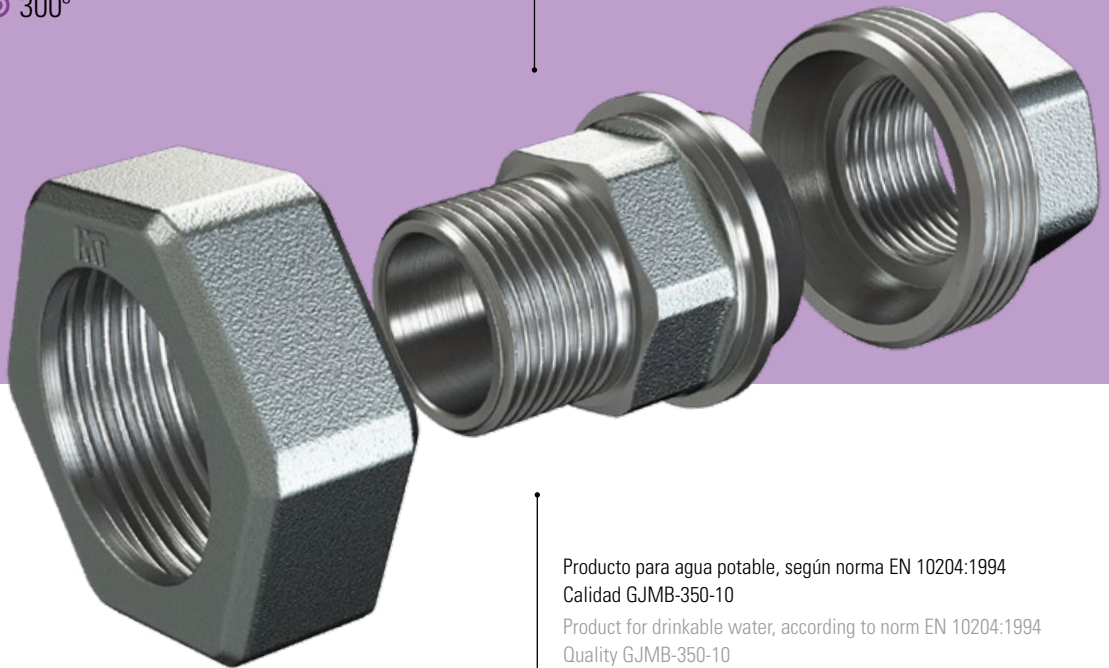

Producto para agua potable, según norma EN 10204:1994
Calidad GJMB-350-10

Product for drinkable water, according to norm EN 10204:1994
Quality GJMB-350-10

Producto
Accesorio de hierro
maleable galvanizado

Product
Malleable galvanized
iron fitting





ROSCADOS
THREADED



FICHA TÉCNICA
TECHNICAL SHEET



CÓDIGO CODE _____
MEDIDA SIZE _____
ENCAJADO GRANDE MASTER CARTON _____
ENCAJADO INTERMEDIO INNER CARTON _____

001



Curva 90° M-H

M-F Long sweep bend 90°

ACS

001-010	3/8"	250	10
001-015	1/2"	180	10
001-020	3/4"	100	10
001-025	1"	40	10
001-032	1 1/4"	20	5
001-040	1 1/2"	20	5
001-050	2"	10	5
001-065	2 1/2"	5	1
001-080	3"	4	1
001-100	4"	1	1

002



Curva 90° H-H

F-F Long sweep bend 90°

ACS

002-010	3/8"	250	10
002-015	1/2"	150	10
002-020	3/4"	80	10
002-025	1"	40	10
002-032	1 1/4"	20	5
002-040	1 1/2"	15	5
002-050	2"	10	5
002-065	2 1/2"	5	1
002-080	3"	2	1
002-100	4"	1	1

003



Curva 90° M-M

M-M Long sweep bend 90°

ACS

003-015	1/2"	300	10
003-020	3/4"	150	10
003-025	1"	60	10
003-032	1 1/4"	40	5
003-040	1 1/2"	25	5
003-050	2"	10	5

040



Curva 45° M-H

M-F Long sweep bend 45°

ACS

040-010	3/8"	300	10
040-015	1/2"	200	10
040-020	3/4"	120	10
040-025	1"	50	10
040-032	1 1/4"	40	5
040-040	1 1/2"	30	5
040-050	2"	15	5
040-065	2 1/2"	10	1
040-080	3"	5	1
040-100	4"	2	1

041



Curva 45° H-H

F-F Long sweep bend 45°

ACS

041-015	1/2"	200	10
041-020	3/4"	120	10
041-025	1"	50	10
041-032	1 1/4"	40	5
041-040	1 1/2"	30	5
041-050	2"	15	5
041-065	2 1/2"	9	1
041-080	3"	5	1
041-100	4"	2	1

CÓDIGO CODE _____
 MEDIDA SIZE _____
 ENCAJADO GRANDE MASTER CARTON _____
 ENCAJADO INTERMEDIO INNER CARTON _____

085



Curva puente H-H F-F crossovers
ACS

085-015	1/2"	100	10
085-020	3/4"	60	10
085-025	1"	30	10

090



Codo 90° H-H F-F Elbow 90°
ACS

090-008	1/4"	400	10
090-010	3/8"	250	10
090-015	1/2"	250	10
090-020	3/4"	140	10
090-025	1"	80	10
090-032	1 1/4"	40	5
090-040	1 1/2"	30	5
090-050	2"	20	5
090-065	2 1/2"	8	1
090-080	3"	6	1
090-100	4"	3	1

092



Codo 90° M-H M-F Elbow 90°
ACS

092-008	1/4"	700	10
092-010	3/8"	500	10
092-015	1/2"	250	10
092-020	3/4"	140	10
092-025	1"	80	10
092-032	1 1/4"	55	5
092-040	1 1/2"	30	5
092-050	2"	16	1
092-065	2 1/2"	12	1
092-080	3"	8	1
092-100	4"	4	1

090R



Codo 90° reducido H-H F-F reducing elbow 90
ACS

090-01510	1/2" x 3/8"	300	10
090-02015	3/4" x 1/2"	160	10
090-02515	1" x 1/2"	110	10
090-02520	1" x 3/4"	100	10
090-03215	1 1/4" x 1/2"	80	5
090-03220	1 1/4" x 3/4"	70	5
090-03225	1 1/4" x 1"	60	5
090-04015	1 1/2" x 1/2"	60	5
090-04020	1 1/2" x 3/4"	60	5
090-04025	1 1/2" x 1"	40	5
090-04032	1 1/2" x 1 1/4"	40	5
090-05015	2" x 1/2"	40	5
090-05020	2" x 3/4"	40	5
090-05025	2" x 1"	30	5
090-05032	2" x 1 1/4"	30	5
090-05040	2" x 1 1/2"	30	5
090-06540	2 1/2" x 1 1/2"	20	1
090-06550	2 1/2" x 2"	20	1
090-08050	3" x 2"	10	1
090-08065	3" x 2 1/2"	6	1

CÓDIGO CODE _____
MEDIDA SIZE _____
ENCAJADO GRANDE MASTER CARTON _____
ENCAJADO INTERMEDIO INNER CARTON _____

096



Codo unión H-H asiento
cónico

ACS

F-F union elbow with
tapered seat

096-015	1/2"	100	10
096-020	3/4"	60	10
096-025	1"	40	10
096-032	1 1/4"	30	5
096-040	1 1/2"	20	5
096-050	2"	12	1

098



Codo unión M-H asiento
cónico

ACS

M-F elbow with tapered
seat

098-010	3/8"	80	10
098-015	1/2"	80	10
098-020	3/4"	50	10
098-025	1"	30	10
098-032	1 1/4"	20	5
098-040	1 1/2"	15	5
098-050	2"	10	5
098-065	2 1/2"	5	1

120



Codo 45° H-H

ACS

F-F Elbow 45°

120-015	1/2"	300	10
120-020	3/4"	180	10
120-025	1"	100	10
120-032	1 1/4"	50	5
120-040	1 1/2"	40	5
120-050	2"	20	5
120-065	2 1/2"	12	1
120-080	3"	6	1
120-100	4"	3	1

180



Cruz H

ACS

F cross

180-010	3/8"	110	10
180-015	1/2"	100	10
180-020	3/4"	70	10
180-025	1"	40	10
180-032	1 1/4"	20	5
180-040	1 1/2"	15	5
180-050	2"	10	5
180-065	2 1/2"	6	1
180-080	3"	5	1
180-100	4"	1	1

221



Codo tres bocas H

ACS

F three outlets elbow

221-015	1/2"	120	10
221-020	3/4"	70	10
221-025	1"	50	10
221-040	1 1/2"	20	5

CÓDIGO CODE
MEDIDA SIZE
ENCAJADO GRANDE MASTER CARTON
ENCAJADO INTERMEDIO INNER CARTON

223



Codo cuatro bocas H F elbow with two laterals

ACS

223-015	1/2"	120	10
223-020	3/4"	70	10
223-025	1"	50	10

130



Te igual H F equal tee

ACS

130-008	1/4"	300	10
130-010	3/8"	200	10
130-015	1/2"	150	10
130-020	3/4"	80	10
130-025	1"	50	10
130-032	1 1/4"	30	5
130-040	1 1/2"	20	5
130-050	2"	12	4
130-065	2 1/2"	8	1
130-080	3"	6	1
130-100	4"	3	1

130R



Te reducida H F reducing tee

ACS

130-02015	3/4" x 1/2"	120	10
130-02515	1" x 1/2"	60	10
130-02520	1" x 3/4"	60	10
130-03215	1 1/4" x 1/2"	40	5
130-03220	1 1/4" x 3/4"	40	5
130-03225	1 1/4" x 1"	30	5
130-04015	1 1/2" x 1/2"	30	5
130-04020	1 1/2" x 3/4"	30	5
130-04025	1 1/2" x 1"	30	5
130-04032	1 1/2" x 1 1/4"	25	5
130-05015	2" x 1/2"	20	5
130-05020	2" x 3/4"	20	5
130-05025	2" x 1"	20	5
130-05032	2" x 1 1/4"	15	5
130-05040	2" x 1 1/2"	15	5
130-06520	2 1/2" x 3/4"	8	1
130-06525	2 1/2" x 1"	8	1
130-06532	2 1/2" x 1 1/4"	8	1
130-06540	2 1/2" x 1 1/2"	8	1
130-06550	2 1/2" x 2"	8	1
130-08040	3" x 1 1/2"	5	1
130-08050	3" x 2"	5	1
130-08065	3" x 2 1/2"	5	1
130-10050	4" x 2"	4	1
130-10065	4" x 2 1/2"	4	1
130-10080	4" x 3"	4	1

CÓDIGO CODE _____
 MEDIDA SIZE _____
 ENCAJADO GRANDE MASTER CARTON _____
 ENCAJADO INTERMEDIO INNER CARTON _____

245



Machón reducción M-M

M-M reducing nipple

ACS

245-00806*	1/4" x 1/8"	800	10
245-01008	3/8" x 1/4"	500	10
245-01508	1/2" x 1/4"	300	10
245-01510	1/2" x 3/8"	200	10
245-02010	3/4" x 3/8"	250	10
245-02015	3/4" x 1/2"	250	10
245-02515	1" x 1/2"	130	10
245-02520	1" x 3/4"	130	10
245-03215	1 1/4" x 1/2"	70	5
245-03220	1 1/4" x 3/4"	70	5
245-03225	1 1/4" x 1"	70	5
245-04020	1 1/2" x 3/4"	60	5
245-04025	1 1/2" x 1"	60	5
245-04032	1 1/2" x 1 1/4"	60	5
245-05025	2" x 1"	30	5
245-05032	2" x 1 1/4"	30	5
245-05040	2" x 1 1/2"	30	5
245-06540	2 1/2" x 1 1/2"	20	1
245-06550	2 1/2" x 2"	20	1
245-08050	3" x 2"	20	1
245-08065	3" x 2 1/2"	20	1
245-10080	4" x 3"	10	1

* Disponible hasta agotar existencias

* While stocks lasts

246



Machón reducción H-M

F-M reducing nipple

ACS

246-01008	3/8" x 1/4"	400	10
246-01508	1/2" x 1/4"	380	10
246-01510	1/2" x 3/8"	380	10
246-02010	3/4" x 3/8"	220	10
246-02015	3/4" x 1/2"	220	10
246-02515	1" x 1/2"	120	10
246-02520	1" x 3/4"	120	10
246-03215	1 1/4" x 1/2"	80	5
246-03220	1 1/4" x 3/4"	80	5
246-03225	1 1/4" x 1"	80	5
246-04020	1 1/2" x 3/4"	60	5
246-04025	1 1/2" x 1"	60	5
246-04032	1 1/2" x 1 1/4"	60	5
246-05025	2" x 1"	30	5
246-05032	2" x 1 1/4"	30	5
246-05040	2" x 1 1/2"	30	5

CÓDIGO CODE _____
MEDIDA SIZE _____
ENCAJADO GRANDE MASTER CARTON _____
ENCAJADO INTERMEDIO INNER CARTON _____

240



Manguito reducción H-H F-F reducing socket

ACS

240-01008	3/8" x 1/4"	600	10
240-01508	1/2" x 1/4"	400	10
240-01510	1/2" x 3/8"	400	10
240-02010	3/4" x 3/8"	250	10
240-02015	3/4" x 1/2"	240	10
240-02515	1" x 1/2"	160	10
240-02520	1" x 3/4"	160	10
240-03215	1 1/4" x 1/2"	90	5
240-03220	1 1/4" x 3/4"	90	5
240-03225	1 1/4" x 1"	90	5
240-04015	1 1/2" x 1/2"	80	5
240-04020	1 1/2" x 3/4"	70	5
240-04025	1 1/2" x 1"	60	5
240-04032	1 1/2" x 1 1/4"	50	5
240-05015	2" x 1/2"	50	5
240-05020	2" x 3/4"	50	5
240-05025	2" x 1"	50	5
240-05032	2" x 1 1/4"	40	5
240-05040	2" x 1 1/2"	40	5
240-06515	2 1/2" x 1/2"	22	1
240-06525	2 1/2" x 1"	22	1
240-06532	2 1/2" x 1 1/4"	22	1
240-06540	2 1/2" x 1 1/2"	22	1
240-06550	2 1/2" x 2"	22	1
240-08040	3" x 1 1/2"	18	1
240-08050	3" x 2"	18	1
240-08065	3" x 2 1/2"	18	1
240-10050	4" x 2"	6	1
240-10065	4" x 2 1/2"	6	1
240-10080	4" x 3"	6	1

270



Manguito H-H F-F socket

ACS

270-006*	1/8"	700	10
270-008	1/4"	700	10
270-010	3/8"	400	10
270-015	1/2"	340	10
270-020	3/4"	220	10
270-025	1"	120	10
270-032	1 1/4"	60	5
270-040	1 1/2"	50	5
270-050	2"	25	5
270-065	2 1/2"	22	1
270-080	3"	18	1
270-100	4"	6	1

* Disponible hasta agotar existencias

* While stocks lasts

CÓDIGO CODE _____
MEDIDA SIZE _____
ENCAJADO GRANDE MASTER CARTON _____
ENCAJADO INTERMEDIO INNER CARTON _____

241



Tuerca reducción M-H

M-F reducing
Bushings

ACS

241-01008	3/8" x 1/4"	1000	10
241-01508	1/2" x 1/4"	800	10
241-01510	1/2" x 3/8"	800	10
241-02008	3/4" x 1/4"	480	10
241-02010	3/4" x 3/8"	480	10
241-02015	3/4" x 1/2"	480	10
241-02508	1" x 1/4"	260	10
241-02510	1" x 3/8"	260	10
241-02515	1" x 1/2"	260	10
241-02520	1" x 3/4"	260	10
241-03215	1 1/4" x 1/2"	160	5
241-03220	1 1/4" x 3/4"	160	5
241-03225	1 1/4" x 1"	160	5
241-04010	1 1/2" x 3/8"	120	5
241-04015	1 1/2" x 1/2"	120	5
241-04020	1 1/2" x 3/4"	120	5
241-04025	1 1/2" x 1"	120	5
241-04032	1 1/2" x 1 1/4"	120	5
241-05015	2" x 1/2"	60	5
241-05020	2" x 3/4"	60	5
241-05025	2" x 1"	60	5
241-05032	2" x 1 1/4"	60	5
241-05040	2" x 1 1/2"	60	5
241-06515	2 1/2" x 1/2"	40	1
241-06520	2 1/2" x 3/4"	40	1
241-06525	2 1/2" x 1"	40	1
241-06532	2 1/2" x 1 1/4"	40	1
241-06540	2 1/2" x 1 1/2"	40	1
241-06550	2 1/2" x 2"	40	1
241-08025	3" x 1"	30	1
241-08032	3" x 1 1/4"	30	1
241-08040	3" x 1 1/2"	30	1
241-08050	3" x 2"	30	1
241-08065	3" x 2 1/2"	30	1
241-10050	4" x 2"	18	1
241-10065	4" x 2 1/2"	18	1
241-10080	4" x 3"	18	1

280



Machón M-M

M-M Hexagon nipple

ACS

280-008	1/4"	500	10
280-010	3/8"	500	10
280-015	1/2"	350	10
280-020	3/4"	250	10
280-025	1"	130	10
280-032	1 1/4"	70	5
280-040	1 1/2"	60	5
280-050	2"	30	5
280-065	2 1/2"	24	1
280-080	3"	18	1
280-100	4"	6	1

CÓDIGO CODE _____
MEDIDA SIZE _____
ENCAJADO GRANDE MASTER CARTON _____
ENCAJADO INTERMEDIO INNER CARTON _____

290



Tapón con reborde M M plug beaded

ACS

290-006*	1/8"	1000	10
290-008	1/4"	1000	10
290-010	3/8"	1000	10
290-015	1/2"	800	10
290-020	3/4"	400	10
290-025	1"	250	10
290-032	1 1/4"	160	5
290-040	1 1/2"	130	5
290-050	2"	60	5
290-065	2 1/2"	50	1
290-080	3"	26	1
290-100	4"	18	1

* Disponible hasta agotar existencias
* While stocks lasts

300



Tapón hexagonal H F hexagon cap

ACS

300-008	1/4"	800	10
300-010	3/8"	800	10
300-015	1/2"	600	10
300-020	3/4"	400	10
300-025	1"	250	10
300-032	1 1/4"	100	5
300-040	1 1/2"	90	5
300-050	2"	70	5
300-065	2 1/2"	25	1
300-080	3"	18	1
300-100	4"	12	1

301



Tapón H F round cap

ACS

301-010	3/8"	800	10
301-015	1/2"	800	10
301-020	3/4"	400	10
301-025	1"	250	10
301-032	1 1/4"	100	5
301-040	1 1/2"	90	5
301-050	2"	70	5
301-065	2 1/2"	25	1
301-080	3"	18	1
301-100	4"	12	1

312



Tuerca hexagonal Locknuts

ACS

312-010	3/8"	600	10
312-015	1/2"	600	10
312-020	3/4"	400	10
312-025	1"	250	10
312-032	1 1/4"	200	5
312-040	1 1/2"	180	5
312-050	2"	110	5

321



Brida redonda base roscada con taladros F floor flange threaded base with holes

ACS

321-015	1/2"	80	10
321-020	3/4"	60	10
321-025	1"	50	10
321-032	1 1/4"	40	5
321-040	1 1/2"	36	4
321-050	2"	24	4
321-065	2 1/2"	15	1
321-080	3"	10	1
321-100	4"	5	1

• Dimensiones agujeros según EN-1.092-1 PN-6
Dimensions according EN-1.092-1 PN-6

CÓDIGO CODE _____
MEDIDA SIZE _____
ENCAJADO GRANDE MASTER CARTON _____
ENCAJADO INTERMEDIO INNER CARTON _____

340



Tuerca unión H-H
asiento cónico

ACS

F-F union with
tapered seat

340-008	1/4"	150	10
340-010	3/8"	150	10
340-015	1/2"	120	10
340-020	3/4"	80	10
340-025	1"	60	10
340-032	1 1/4"	40	5
340-040	1 1/2"	30	5
340-050	2"	20	5
340-065	2 1/2"	10	1
340-080	3"	6	1
340-100	4"	2	1

341



Tuerca unión M-H
asiento cónico

ACS

M-F union with
tapered seat

341-008	1/4"	150	10
341-010	3/8"	150	10
341-015	1/2"	100	10
341-020	3/4"	60	10
341-025	1"	40	10
341-032	1 1/4"	30	5
341-040	1 1/2"	20	5
341-050	2"	15	5
341-065	2 1/2"	8	1
341-080	3"	6	1
341-100	4"	2	1

529



Manguito M-H

ACS

M-F socket

529-015	1/2"	360	10
529-020	3/4"	220	10
529-025	1"	120	10
529-032	1 1/4"	80	5
529-040	1 1/2"	60	5
529-050	2"	30	5

3

AUTOMATIZACIÓN DE VÁLVULAS

VALVES AUTOMATION

SERVICIO INTEGRAL DE MONTAJE Y ENTREGA INMEDIATA EN 24 HORAS



En MT no nos gustan las sorpresas y los problemas derivados de un mal montaje de nuestros productos. Es por este motivo, que disponemos de personal técnico especializado para adaptar el automatismo correcto en cada una de nuestras válvulas y las probamos antes de mandar al cliente. Con ello garantizamos un correcto funcionamiento de nuestras válvulas actuadas y ofrecemos un servicio rápido de montaje y entrega en un tiempo récord. MT, buscando siempre la mejor solución para nuestro cliente.

INTEGRAL ASSEMBLY SERVICE AND IMMEDIATE DELIVERY IN 24 HOURS

In MT we don't like the surprises and the problems derived from a bad assembly of our products. For this reason, we have specialized technical personnel to adapt the correct automation in each of our valves and test them before sending the customer. With this we guarantee the correct functioning of our actuated valves and we offer a fast service of assembly and delivery in a record time. MT, always looking for the best solution for our client.



Rango de temperatura °C
Temperature range °C



Presión máxima de trabajo en Bar
Maximum working pressure Bar



Cuerpo en fundición nodular GGG-40 con recubrimiento pintura Epoxi RAL5013
Ductile Iron body GGG-40 with Epoxy coating paint RAL5013

Producto 5105140
Válvula de mariposa tipo wafer EPDM disco poliámi- da 11 con actuador (p.178)

Product 5105140
Butterfly valve wafer type stainless steel disc EPDM hard seat with actuator (p.178)



DATOS TÉCNICOS TECHNICAL DATA SHEET

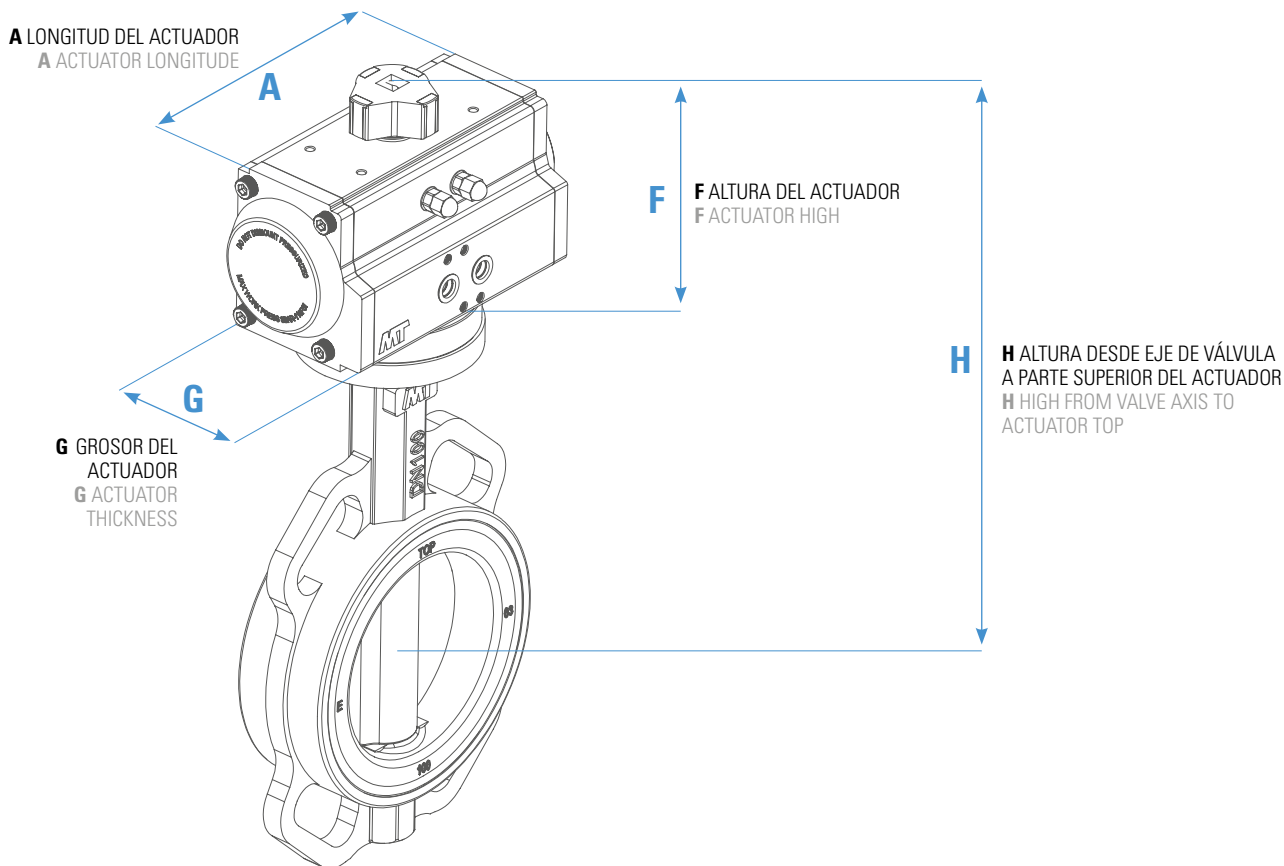

ACTUADORES NEUMÁTICOS PNEUMATIC ACTUATORS

5100



Actuador neumático simple efecto

Pneumatic simple return actuator



FICHA TÉCNICA
TECHNICAL SHEET

CÓDIGO CODE	6 BAR	8 BAR	Muelle Final Final Doc	ISO 5211	s
5100-052	12,5	21	9,5	F03-F05	11
5100-063	21	36	16,3	F05-F07	11
5100-075	37,1	61,8	24,4	F05-F07	14
5100-083	45,7	78,2	35,6	F05-F07	17
5100-092	66,9	113,5	52,3	F05-F07	17
5100-105	97,2	166,5	94,3	F07-F10	17
5100-125	177	299	127	F07-F10	22
5100-140	220	405	222	F10-F12	27
5100-160	338	619	343	F10-F12	27
5100-190	524	978	557	F14	27
5100-210	750	1373	713	F14	36
5100-240	1018	1995	1075	F16	36
5100-270	1633	3007	1295	F16	46

5200



Actuador neumático doble efecto

Pneumatic double acting actuator



FICHA TÉCNICA
TECHNICAL SHEET

CÓDIGO CODE	6 BAR	8 BAR	ISO 5211	s
5200-052	25,5	34	F03-F05	11
5200-063	44,9	59,9	F05-F07	11
5200-075	74,2	99	F05-F07	14
5200-083	97,4	130	F05-F07	17
5200-092	140	186	F05-F07	17
5200-105	207,8	227	F07-F10	17
5200-125	368	490,8	F07-F10	22
5200-140	554	739	F10-F12	27
5200-160	844	1126	F10-F12	27
5200-190	1361	1814	F14	27
5200-210	1870	2493	F14	36
5200-240	2931	3908	F16	36
5200-270	4122	5496	F16	46

540052



Electroválvulas normativa
namur 5/2 vías

Series namur type 5/2
ways solenoid valve



FICHA TÉCNICA
TECHNICAL SHEET

CÓDIGO CODE	VOLTAJE VOLTAGE
540052-01	DC24V
540052-02	AC24V-DC12V
540052-03	AC110V
540052-04	AC220V

- Utilizada para actuadores doble efecto, salvo excepciones.
Doble acting actuators used, with exceptions.

540032



Electroválvulas normativa
namur 3/2 vías

Series namur type 3/2
ways solenoid valve



FICHA TÉCNICA
TECHNICAL SHEET

CÓDIGO CODE	VOLTAJE VOLTAGE
540032-01	DC24V
540032-02	AC24V-DC12V
540032-03	AC110V
540032-04	AC220V

- Utilizada para actuadores simple efecto, salvo excepciones.
Spring return actuators used, with exceptions.

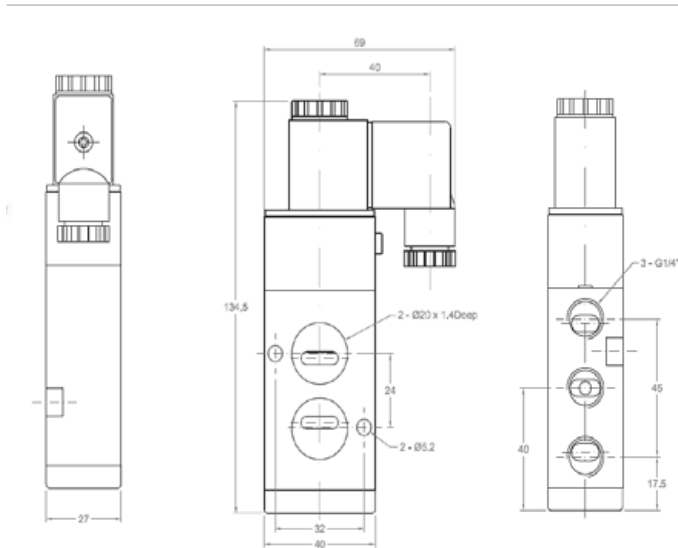

CÓDIGO CODE	ESQUEMA DIAGRAM	MATERIAL CUERPO BODY MATERIAL	MATERIAL JUNTA SEALS MATERIAL
540052		Aluminio anodizado Anonized aluminium	NBR
540032		Aluminio anodizado Anonized aluminium	NBR

CÓDIGO CODE	NÚMERO POSICIÓN POSITION NUMBER	VOLTAJE BOBINA COLL VOLTAGE	TAMAÑO PUERTO PORT SIZE	CONECTOR DISPONIBLE AVAILABLE CONNECTOR	CONSUMO POWER CONSUMPTION
540052	5 Position 2 way	DC12V DC24V AC24V	1/4"	With led	AC 4.5VA DC: 3W
540032	3 Position 2 ways	DC110V AC110V AC220V	1/4"	-	AC 4.5VA DC: 3W

51SMC



Posicionador para actuador
neumático 4/20mA-0/10V

Pneumatic electric actuator
positioner 4/20mA-0/10V



FICHA TÉCNICA
TECHNICAL SHEET

CÓDIGO CODE
51SMC

- Especificar el tipo de señal en el pedido 4-20mA o 0-10V
Specify signal input 4-20mA or 0-20 in the order.

51CFC



Caja final de carrera

End microbox



FICHA TÉCNICA
TECHNICAL SHEET

CÓDIGO CODE
51CFC

- Caja polipropileno + 15% fibra de vidrio
Polypropilene + 15% fiber glass box
- Soporte acero + epoxi para condiciones ambientales extremas como opción en soporte inoxidable.
Steel + epoxy brackets stainless steel for extreme weather optional.
- Unión soporte Namur
Univeral Namur
- 2 micros mecánicos
2 mechanical switches

ACTUADORES NEUMÁTICOS PNEUMATIC ACTUATORS

5300
5324



Actuador eléctrico		Electric actuator		
CÓDIGO CODE	PAR NM	VOLTAJE VOLTAGE	ISO 5211	s
5300-010 5324-010	10	85v-240v 24v	F03-F04-F05	14
5300-020 5324-020	20	24v-240v 12v	F03-F04-F05	14
5300-035 5324-035	35	24v-240v 12v	F03-F04-F05	14
5300-055 5324-055	55	24v-240v 12v	F05-F07	17
5300-085 5324-085	85	24v-240v 12v	F05-F07	17
5300-140 5324-140	140	24v-240v 12v	F07-F10	22
5300-300 5324-300	300	24v-240v 12v	F07-F10	22

CÓDIGO CODE	VOLTAJE VOLTAGE
5300-010	85v-240v VAC/VDC
5300-020	24v-240v VAC/VDC
5300-035	24v-240v VAC/VDC
5300-055	24v-240v VAC/VDC
5300-085	24v-240v VAC/VDC
5300-140	24v-240v VAC/VDC
5300-300	24v-240v VAC/VDC
5324-010	24v VAC/VDC
5324-020	12v VAC/VDC
5324-035	12v VAC/VDC
5324-055	12v VAC/VDC
5324-085	12v VAC/VDC
5324-140	12v VAC/VDC
5324-300	12v VAC/VDC



FICHA TÉCNICA
TECHNICAL SHEET

51DPS



Kit posicionador para actuador eléctrico 4/20mA-0/10V
Electric actuator positioner kit 4/20mA-0/10V



FICHA TÉCNICA
TECHNICAL SHEET

CÓDIGO CODE
51DPS01*
51DPS02**

- Especificar el tipo de señal en el pedido 4-20mA ó 0-10V
Specify signal input 4-20mA or 0-10V before order
- * Para actuadores eléctricos 20/35/55/85
* For electric actuators 20/35/55/85
- **Para actuadores eléctricos 140/300
**For electric actuators 140/300

51BSR



Kit bloque de seguridad para actuador eléctrico
Safety lock electric actuator kit



FICHA TÉCNICA
TECHNICAL SHEET

CÓDIGO CODE
51BSR01*
51BSR02**

- El actuador gira a su posición predeterminada en caso de falta de tensión
Actuator goes to initial position in case no voltage
- * Para actuadores eléctricos 20/35/55/85
* For electric actuators 20/35/55/85
- **Para actuadores eléctricos 140/300
**For electric actuators 140/300

DATOS TÉCNICOS ISO 5211 ISO 5211 DATA SHEET

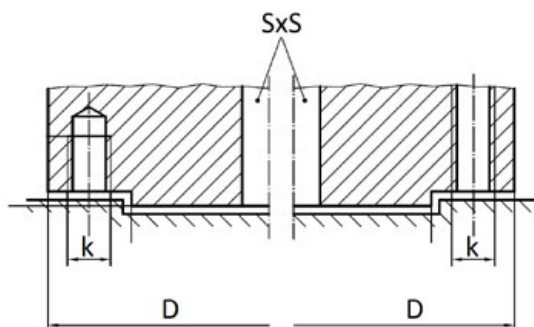

BRIDA FLANGE	PAR MÁX. N·m MAX. TORQUE N·m	D	D (K)	SXS	n
F03	32	46	M5	9	4
F04	63	54	M5	9 - 11	4
F05	125	65	M6	9 - 14	4
F07	250	90	M8	11 - 17	4
F10	500	125	M10	14 - 22	4
F12	1.000	150	M12	17 - 27	4
F14	2.000	175	M16	22 - 36	4
F16	4.000	210	M20	27 - 46	8
F25	8.000	300	M16	36 - 55	8
F30	16.000	350	M20	46 - 75	8
F35	32.000	415	M30	-	8
F40	63.000	475	M36	-	8
F48	125.000	560	M36	-	12
F60	250.000	686	M36	-	20

CÓDIGO CODE _____
 ACTUADOR ACTUATOR _____
H ALTURA DESDE EJE DE VÁLVULA A PARTE SUPERIOR DEL ACTUADOR
 HIGH FROM VALVE AXIS TO ACTUATOR TOP _____
F ALTURA DEL ACTUADOR ACTUATOR HIGH _____
A LONGITUD DEL ACTUADOR ACTUATOR LONGITUDE _____
G GROSOR DEL ACTUADOR ACTUATOR THICKNESS _____
 MEDIDA SIZE _____

5114
5105114
 SIMPLE EFECTO
 SIMPLE RETURN
 ACTUATOR



Válvula de mariposa tipo
 wafer disco inoxidable
 asiento blando EPDM con
 actuador
 Butterfly valve wafer type
 stainless steel disc EPDM
 soft seat with actuator



5105114-040	5100052	248	92	145	71	1 1/2"
5105114-050	5100075	276	120	201	94	2"
5105114-065	5100075	288	120	201	94	2 1/2"
5105114-080	5100083	304	128	209	101	3"
5105114-100	5100083	321	128	209	101	4"
5105114-125	5100125	383	175	332	138	5"
5105114-150	5100125	394	175	332	138	6"
5105114-200	5100160	484	217	450	174	8"
5105114-250	5100160	514	217	450	174	10"
5105114-300	5100190	627	260	507	206	12"

- Actuadores neumáticos ATEX. Para diámetros superiores consultar disponibilidad
 Pneumatic actuators ATEX. Larger diameters under request
- Los actuadores neumáticos están calculados en base a una presión de aire de entrada de 6 Bares
 Pneumatic actuators are calculated based on a inlet air pressure of 6 Bar

5114
5205114
 DOBLE EFECTO
 DOUBLE ACTING
 ACTUATOR



Válvula de mariposa tipo
 wafer disco inoxidable
 asiento blando EPDM con
 actuador
 Butterfly valve wafer type
 stainless steel disc EPDM
 soft seat with actuator



5205114-040	5200052	238	92	145	71	1 1/2"
5205114-050	5200052	248	92	145	71	2"
5205114-065	5200052	260	92	145	71	2 1/2"
5205114-080	5200063	284	108	169	82	3"
5205114-100	5200063	301	108	169	82	4"
5205114-125	5200083	336	128	209	101	5"
5205114-150	5200083	347	128	209	101	6"
5205114-200	5200105	420	153	275	122	8"
5205114-250	5200125	472	175	332	138	10"
5205114-300	5200140	559	192	385	153	12"

- Actuadores neumáticos ATEX. Para diámetros superiores consultar disponibilidad
 Pneumatic actuators ATEX. Larger diameters under request
- Los actuadores neumáticos están calculados en base a una presión de aire de entrada de 6 Bares
 Pneumatic actuators are calculated based on a inlet air pressure of 6 Bar

5114
5325114
 ACTUADOR
 ELÉCTRICO
 BAJO VOLTAJE
 ELECTRIC
 ACTUATOR
 LOW VOLTAGE



Válvula de mariposa tipo
 wafer disco inoxidable
 asiento blando EPDM con
 actuador
 Butterfly valve wafer type
 stainless steel disc EPDM
 soft seat with actuator

5325114-040	5324020	315	169	181	110	1 1/2"
5325114-050	5324020	325	169	181	110	2"
5325114-065	5324035	337	169	181	110	2 1/2"
5325114-080	5324055	345	169	181	110	3"
5325114-100	5324055	389	196	181	110	4"
5325114-125	5324085	404	196	181	128	5"
5325114-150	5324140	458	254	235	214	6"
5325114-200	5324300	521	254	235	214	8"
5325114-250	5324300	551	254	235	214	10"

- 12V VAC/VDC
- Para diámetros superiores consultar disponibilidad. Larger diameters under request

5114
5305114
 ACTUADOR
 ELÉCTRICO
 ALTO VOLTAJE
 ELECTRIC
 ACTUATOR
 HIGH VOLTAGE



Válvula de mariposa tipo
 wafer disco inoxidable
 asiento blando EPDM con
 actuador
 Butterfly valve wafer type
 stainless steel disc EPDM
 soft seat with actuator

5305114-040	5300020	315	169	181	110	1 1/2"
5305114-050	5300020	325	169	181	110	2"
5305114-065	5300035	337	169	181	110	2 1/2"
5305114-080	5300055	345	169	181	110	3"
5305114-100	5300055	389	196	181	110	4"
5305114-125	5300085	404	196	181	128	5"
5305114-150	5300140	458	254	235	214	6"
5305114-200	5300300	521	254	235	214	8"
5305114-250	5300300	551	254	235	214	10"

- 24V-240V VAC/VDC
- Para diámetros superiores consultar disponibilidad. Larger diameters under request

Para temperaturas superiores a 70°C se debe montar un puente separador entre la válvula y el actuador.
 At temperatures above 70°C separating bridge must be mounted between the valve and the actuator.

CÓDIGO CODE
 ACTUADOR ACTUATOR
H ALTURA DESDE EJE DE VÁLVULA A PARTE SUPERIOR DEL ACTUADOR
 HIGH FROM VALVE AXIS TO ACTUATOR TOP
F ALTURA DEL ACTUADOR ACTUATOR HIGH
A LONGITUD DEL ACTUADOR ACTUATOR LENGTH
G GROSOR DEL ACTUADOR ACTUATOR THICKNESS
 MEDIDA SIZE

5115
5105115
 SIMPLE EFECTO
 SIMPLE RETURN
 ACTUATOR



Válvula de mariposa tipo
 wafer disco cromado
 asiento rígido EPDM con
 actuador

Butterfly valve wafer type
 chromed disc EPDM hard
 seat with actuator



5105115-050	5100063	249	108	169	82	2"
5105115-065	5100075	272	120	201	94	2 1/2"
5105115-080	5100092	300	140	242	109	3"
5105115-100	5100092	325	140	242	109	4"
5105115-125	5100105	353	153	275	122	5"
5105115-150	5100125	380	175	332	138	6"
5105115-200	5100140	447	192	385	153	8"
5105115-250	5100160	482	192	385	153	10"
5105115-300	5100190	590	260	507	206	12"

- Actuadores neumáticos ATEX. Para diámetros superiores consultar disponibilidad
 Pneumatic actuators ATEX. Larger diameters under request
- Los actuadores neumáticos están calculados en base a una presión de aire de entrada de 6 Bares
 Pneumatic actuators are calculated based on an inlet air pressure of 6 Bar

5115
5205115
 DOBLE EFECTO
 DOUBLE ACTING
 ACTUATOR



Válvula de mariposa tipo
 wafer disco cromado
 asiento rígido EPDM con
 actuador

Butterfly valve wafer type
 chromed disc EPDM hard
 seat with actuator



5205115-050	5200052	233	92	145	71	2"
5205115-065	5200052	244	92	145	71	2 1/2"
5205115-080	5200063	268	108	169	82	3"
5205115-100	5200063	293	108	169	82	4"
5205115-125	5200075	320	120	201	94	5"
5205115-150	5200083	348	128	209	101	6"
5205115-200	5200105	408	153	275	122	8"
5205115-250	5200105	443	153	275	122	10"
5205115-300	5200125	505	175	332	138	12"

- Actuadores neumáticos ATEX. Para diámetros superiores consultar disponibilidad
 Pneumatic actuators ATEX. Larger diameters under request
- Los actuadores neumáticos están calculados en base a una presión de aire de entrada de 6 Bares
 Pneumatic actuators are calculated based on an inlet air pressure of 6 Bar

5115
5325115
 ACTUADOR
 ELÉCTRICO
 BAJO VOLTAJE
 ELECTRIC
 ACTUATOR
 LOW VOLTAGE



Válvula de mariposa tipo
 wafer disco cromado
 asiento rígido EPDM con
 actuador

Butterfly valve wafer type
 chromed disc EPDM hard
 seat with actuator

5325115-050	5324020	310	169	181	110	2"
5325115-065	5324035	321	169	181	110	2 1/2"
5325115-080	5324055	356	196	181	110	3"
5325115-100	5324055	381	196	181	110	4"
5325115-125	5324085	396	196	181	128	5"
5325115-150	5324140	474	254	235	214	6"
5325115-200	5324300	514	254	235	214	8"
5325115-250	5324300	544	254	235	214	10"

- 12V VAC/VDC
- Para diámetros superiores consultar disponibilidad. Larger diameters under request

5115
5305115
 ACTUADOR
 ELÉCTRICO
 ALTO VOLTAJE
 ELECTRIC
 ACTUATOR
 HIGH VOLTAGE



Válvula de mariposa tipo
 wafer disco cromado
 asiento rígido EPDM con
 actuador

Butterfly valve wafer type
 chromed disc EPDM hard
 seat with actuator

5305115-050	5300020	310	169	181	110	2"
5305115-065	5300035	321	169	181	110	2 1/2"
5305115-080	5300055	356	196	181	110	3"
5305115-100	5300055	381	196	181	110	4"
5305115-125	5300085	396	196	181	128	5"
5305115-150	5300140	474	254	235	214	6"
5305115-200	5300300	514	254	235	214	8"
5305115-250	5300300	544	254	235	214	10"

- 24V-240V VAC/VDC
- Para diámetros superiores consultar disponibilidad. Larger diameters under request

Para temperaturas superiores a 70°C se debe montar un puente separador entre la válvula y el actuador.
 At temperatures above 70°C separating bridge must be mounted between the valve and the actuator.

CÓDIGO CODE _____
 ACTUADOR ACTUATOR _____
H ALTURA DESDE EJE DE VÁLVULA A PARTE SUPERIOR DEL ACTUADOR
 HIGH FROM VALVE AXIS TO ACTUATOR TOP _____
F ALTURA DEL ACTUADOR ACTUATOR HIGH _____
A LONGITUD DEL ACTUADOR ACTUATOR LONGITUDE _____
G GROSOR DEL ACTUADOR ACTUATOR THICKNESS _____
 MEDIDA SIZE _____

51151
51051151
 SIMPLE EFECTO
 SIMPLE RETURN
 ACTUATOR



Válvula de mariposa tipo
 wafer disco inoxidable
 asiento rígido EPDM con
 actuador
 Butterfly valve wafer type
 stainless steel disc EPDM
 hard seat with actuator



51051151-040	5100052	215	92	145	71	1 1/2"
51051151-050	5100075	261	120	201	94	2"
51051151-065	5100075	272	120	201	94	2 1/2"
51051151-080	5100092	300	140	242	108,5	3"
51051151-100	5100105	338	153	275	122	4"
51051151-125	5100105	353	153	275	122	5"
51051151-150	5100105	373	153	275	122	6"
51051151-200	5100140	451,5	191,5	385	153	8"
51051151-250	5100160	507	217	450	174	10"
51051151-300	5100190	590	260	507	206	12"

- Actuadores neumáticos ATEX. Para diámetros superiores consultar disponibilidad
 Pneumatic actuators ATEX. Larger diameters under request
- Los actuadores neumáticos están calculados en base a una presión de aire de entrada de 6 Bares
 Pneumatic actuators are calculated based on a inlet air pressure of 6 Bar

51151
52051151
 DOBLE EFECTO
 DOUBLE ACTING
 ACTUATOR



Válvula de mariposa tipo
 wafer disco inoxidable
 asiento rígido EPDM con
 actuador
 Butterfly valve wafer type
 stainless steel disc EPDM
 hard seat with actuator



52051151-040	5200052	215	92	145	71	1 1/2"
52051151-050	5200052	233	92	145	71	2"
52051151-065	5200052	244	92	145	71	2 1/2"
52051151-080	5200075	280	120	201	94	3"
52051151-100	5200075	305	120	201	94	4"
52051151-125	5200075	320	120	201	94	5"
52051151-150	5200083	348	128	209	101	6"
52051151-200	5200105	408	153	275	122	8"
52051151-250	5200125	465	175	332	137,5	10"
52051151-300	5200140	521,5	191,5	385	153	12"

- Actuadores neumáticos ATEX. Para diámetros superiores consultar disponibilidad
 Pneumatic actuators ATEX. Larger diameters under request
- Los actuadores neumáticos están calculados en base a una presión de aire de entrada de 6 Bares
 Pneumatic actuators are calculated based on a inlet air pressure of 6 Bar

51151
53251151
 ACTUADOR
 ELÉCTRICO
 BAJO VOLTAJE
 ELECTRIC
 ACTUATOR
 LOW VOLTAGE



Válvula de mariposa tipo
 wafer disco inoxidable
 asiento rígido EPDM con
 actuador
 Butterfly valve wafer type
 stainless steel disc EPDM
 hard seat with actuator

53251151-040	5324020	300	169	181	110	1 1/2"
53251151-050	5324020	310	169	181	110	2"
53251151-065	5324035	321	169	181	110	2 1/2"
53251151-080	5324055	356	196	181	110	3"
53251151-100	5324055	381	196	181	110	4"
53251151-125	5324085	396	196	181	128	5"
53251151-150	5324140	416	196	181	128	6"
53251151-200	5324300	514	254	235	214	8"
53251151-250	5324300	544	254	235	214	10"

- 12V VAC/VDC
- Para diámetros superiores consultar disponibilidad. Larger diameters under request

51151
53051151
 ACTUADOR
 ELÉCTRICO
 ALTO VOLTAJE
 ELECTRIC
 ACTUATOR
 HIGH VOLTAGE



Válvula de mariposa tipo
 wafer disco inoxidable
 asiento rígido EPDM con
 actuador
 Butterfly valve wafer type
 stainless steel disc EPDM
 hard seat with actuator

53051151-040	5300020	300	169	181	110	1 1/2"
53051151-050	5300020	310	169	181	110	2"
53051151-065	5300035	321	169	181	110	2 1/2"
53051151-080	5300055	356	196	181	110	3"
53051151-100	5300055	381	196	181	110	4"
53051151-125	5300085	396	196	181	128	5"
53051151-150	5324140	416	196	181	128	6"
53051151-200	5300300	514	254	235	214	8"
53051151-250	5300300	544	254	235	214	10"

- 24V-240V VAC/VDC
- Para diámetros superiores consultar disponibilidad. Larger diameters under request

Para temperaturas superiores a 70°C se debe montar un puente separador entre la válvula y el actuador.
 At temperatures above 70°C separating bridge must be mounted between the valve and the actuator.

CÓDIGO CODE
 ACTUADOR ACTUATOR
H ALTURA DESDE EJE DE VÁLVULA A PARTE SUPERIOR DEL ACTUADOR
 HIGH FROM VALVE AXIS TO ACTUATOR TOP
F ALTURA DEL ACTUADOR ACTUATOR HIGH
A LONGITUD DEL ACTUADOR ACTUATOR LONGITUDE
G GROSOR DEL ACTUADOR ACTUATOR THICKNESS
 MEDIDA SIZE

5140
5105140
 SIMPLE EFECTO
 SIMPLE RETURN
 ACTUATOR



Válvula de mariposa tipo wafer EPDM disco poliámi- da 11 con actuador
 Butterfly valve wafer type stainless steel disc EPDM hard seat with actuator

ATEX

5105140-050	5100075	276	120	201	94	2"
5105140-065	5100075	288	120	201	94	2 1/2"
5105140-080	5100092	316	140	242	108,5	3"
5105140-100	5100105	346	153	275	122	4"
5105140-125	5100140	384,5	191,5	385	153	5"
5105140-150	5100140	395,5	191,5	385	153	6"
5105140-200	5100190	527	260	507	206	8"
5105140-250	5100190	557	260	507	206	10"

- Actuadores neumáticos ATEX. Para diámetros superiores consultar disponibilidad
Pneumatic actuators ATEX. Larger diameters under request
- Los actuadores neumáticos están calculados en base a una presión de aire de entrada de 6 Bares
Pneumatic actuators are calculated based on a inlet air pressure of 6 Bar

5140
5205140
 DOBLE EFECTO
 DOUBLE ACTING
 ACTUATOR



Válvula de mariposa tipo wafer EPDM disco poliámi- da 11 con actuador
 Butterfly valve wafer type stainless steel disc EPDM hard seat with actuator

ATEX

5205140-050	5200052	248	92	145	71	2"
5205140-065	5200052	260	92	145	71	2 1/2"
5205140-080	5200063	284	108	169	82	3"
5205140-100	5200075	313	120	201	94	4"
5205140-125	5200092	348	140	242	108,5	5"
5205140-150	5200092	344	140	242	108,5	6"
5205140-200	5200125	442	175	332	137,5	8"
5205140-250	5200125	472	175	332	137,5	10"

- Actuadores neumáticos ATEX. Para diámetros superiores consultar disponibilidad
Pneumatic actuators ATEX. Larger diameters under request
- Los actuadores neumáticos están calculados en base a una presión de aire de entrada de 6 Bares
Pneumatic actuators are calculated based on a inlet air pressure of 6 Bar

5140
5325140
 ACTUADOR
 ELÉCTRICO
 BAJO VOLTAJE
 ELECTRIC
 ACTUATOR
 LOW VOLTAGE



Válvula de mariposa tipo wafer EPDM disco poliámi- da 11 con actuador
 Butterfly valve wafer type stainless steel disc EPDM hard seat with actuator

5325140-050	5324020	325	169	181	110	2"
5325140-065	5324035	337	169	181	110	2 1/2"
5325140-080	5324055	345	169	181	110	3"
5325140-100	5324055	389	196	181	110	4"
5325140-125	5324140	447	254	235	214	5"
5325140-150	5324140	458	254	235	214	6"
5325140-200	5324300	521	254	235	214	8"

- 12V VAC/VDC
- Para diámetros superiores consultar disponibilidad. Larger diameters under request

5140
5305140
 ACTUADOR
 ELÉCTRICO
 ALTO VOLTAJE
 ELECTRIC
 ACTUATOR
 HIGH VOLTAGE



Válvula de mariposa tipo wafer EPDM disco poliámi- da 11 con actuador
 Butterfly valve wafer type stainless steel disc EPDM hard seat with actuator

5305140-050	5300020	325	169	181	110	2"
5305140-065	5300035	337	169	181	110	2 1/2"
5305140-080	5300055	345	169	181	110	3"
5305140-100	5300055	389	196	181	110	4"
5305140-125	5300140	447	254	235	214	5"
5305140-150	5300140	458	254	235	214	6"
5305140-200	5300300	521	254	235	214	8"

- 24V-240V VAC/VDC
- Para diámetros superiores consultar disponibilidad. Larger diameters under request

Para temperaturas superiores a 70°C se debe montar un puente separador entre la válvula y el actuador.
 At temperatures above 70°C separating bridge must be mounted between the valve and the actuator.

CÓDIGO CODE
 ACTUADOR ACTUATOR
 H ALTURA DESDE EJE DE VÁLVULA A PARTE SUPERIOR DEL ACTUADOR
 HIGH FROM VALVE AXIS TO ACTUATOR TOP
 F ALTURA DEL ACTUADOR ACTUATOR HIGH
 A LONGITUD DEL ACTUADOR ACTUATOR LONGITUDE
 G GROSOR DEL ACTUADOR ACTUATOR THICKNESS
 MEDIDA SIZE

51142
51051142
 SIMPLE EFECTO
 SIMPLE RETURN
 ACTUATOR



Válvula de mariposa tipo wafer disco inoxidable asiento blando NBR con actuador

Butterfly valve wafer type stainless steel disc NBR soft seat with actuator

ATEX

51051142-050	5100075	276	120	201	94	2"
51051142-065	5100075	288	120	201	94	2 1/2"
51051142-080	5100083	304	128	209	101	3"
51051142-100	5100083	321	128	209	101	4"
51051142-125	5100125	383	175	332	137,5	5"
51051142-150	5100125	394	175	332	137,5	6"
51051142-200	5100160	484	217	450	174	8"
51051142-250	5100190	557	260	507	206	10"

- Actuadores neumáticos ATEX. Para diámetros superiores consultar disponibilidad
Pneumatic actuators ATEX. Larger diameters under request
- Los actuadores neumáticos están calculados en base a una presión de aire de entrada de 6 Bares
Pneumatic actuators are calculated based on a inlet air pressure of 6 Bar

51142
52051142
 DOBLE EFECTO
 DOUBLE ACTING
 ACTUATOR



Válvula de mariposa tipo wafer disco inoxidable asiento blando NBR con actuador

Butterfly valve wafer type stainless steel disc NBR soft seat with actuator

ATEX

52051142-050	5200052	248	92	145	71	2"
52051142-065	5200052	260	92	145	71	2 1/2"
52051142-080	5200063	284	108	169	82	3"
52051142-100	5200063	301	108	169	82	4"
52051142-125	5200083	336	128	209	101	5"
52051142-150	5200092	359	140	242	109	6"
52051142-200	5200125	442	175	332	138	8"
52051142-250	5200140	489	192	385	153	10"

- Actuadores neumáticos ATEX. Para diámetros superiores consultar disponibilidad
Pneumatic actuators ATEX. Larger diameters under request
- Los actuadores neumáticos están calculados en base a una presión de aire de entrada de 6 Bares
Pneumatic actuators are calculated based on a inlet air pressure of 6 Bar

51142
53251142
 ACTUADOR ELÉCTRICO BAJO VOLTAJE
 ELECTRIC ACTUATOR LOW VOLTAGE



Válvula de mariposa tipo wafer disco inoxidable asiento blando NBR con actuador

Butterfly valve wafer type stainless steel disc NBR soft seat with actuator

53251142-050	5324020	325	169	181	110	2"
53251142-065	5324035	337	169	181	110	2 1/2"
53251142-080	5324055	345	169	181	110	3"
53251142-100	5324055	389	196	181	110	4"
53251142-125	5324085	404	196	181	128	5"
53251142-150	5324140	458	254	235	214	6"
53251142-200	5324300	521	254	235	214	8"
53251142-250	5324300	551	254	235	214	10"

- 12V VAC/VDC
- Para diámetros superiores consultar disponibilidad. Larger diameters under request

51142
53051142
 ACTUADOR ELÉCTRICO ALTO VOLTAJE
 ELECTRIC ACTUATOR HIGH VOLTAGE



Válvula de mariposa tipo wafer disco inoxidable asiento blando NBR con actuador

Butterfly valve wafer type stainless steel disc NBR soft seat with actuator

53051142-050	5300020	325	169	181	110	2"
53051142-065	5300035	337	169	181	110	2 1/2"
53051142-080	5300055	345	169	181	110	3"
53051142-100	5300055	389	196	181	110	4"
53051142-125	5300085	404	196	181	128	5"
53051142-150	5300140	458	254	235	214	6"
53051142-200	5300300	521	254	235	214	8"
53051142-250	5300300	551	254	235	214	10"

- 24V-240V VAC/VDC
- Para diámetros superiores consultar disponibilidad. Larger diameters under request

Para temperaturas superiores a 70°C se debe montar un puente separador entre la válvula y el actuador.
 At temperatures above 70°C separating bridge must be mounted between the valve and the actuator.

CÓDIGO CODE
 ACTUADOR ACTUATOR
H ALTURA DESDE EJE DE VÁLVULA A PARTE SUPERIOR DEL ACTUADOR
 HIGH FROM VALVE AXIS TO ACTUATOR TOP
F ALTURA DEL ACTUADOR ACTUATOR HIGH
A LONGITUD DEL ACTUADOR ACTUATOR LENGTH
G GROSOR DEL ACTUADOR ACTUATOR THICKNESS
 MEDIDA SIZE

5144
5105144
 SIMPLE EFECTO
 SIMPLE RETURN
 ACTUATOR



Válvula de mariposa tipo
 lug disco inoxidable asiento
 blando NBR con actuador
 Butterfly valve lug type
 stainless steel disc NBR
 soft seat with actuator



5105144-050	5100075	276	120	201	94	2"
5105144-065	5100083	296	128	209	101	2 1/2"
5105144-080	5100092	316	140	242	108,5	3"
5105144-100	5100105	346	153	275	122	4"
5105144-125	5100125	383	175	332	137,5	5"
5105144-150	5100140	415,5	191,5	385	153	6"
5105144-200	5100140	458,5	191,5	385	153	8"

- Actuadores neumáticos ATEX. Para diámetros superiores consultar disponibilidad
 Pneumatic actuators ATEX. Larger diameters under request
- Los actuadores neumáticos están calculados en base a una presión de aire de entrada de 6 Bares
 Pneumatic actuators are calculated based on an inlet air pressure of 6 Bar

5144
5205144
 DOBLE EFECTO
 DOUBLE ACTING
 ACTUATOR



Válvula de mariposa tipo
 lug disco inoxidable asiento
 blando NBR con actuador
 Butterfly valve lug type
 stainless steel disc NBR
 soft seat with actuator



5205144-050	5200052	248	92	145	71	2"
5205144-065	5200063	276	108	169	82	2 1/2"
5205144-080	5200075	296	120	201	94	3"
5205144-100	5200075	313	120	201	94	4"
5205144-125	5200092	348	140	242	108,5	5"
5205144-150	5200092	359	140	242	108,5	6"
5205144-200	5200105	420	153	275	122	8"

- Actuadores neumáticos ATEX. Para diámetros superiores consultar disponibilidad
 Pneumatic actuators ATEX. Larger diameters under request
- Los actuadores neumáticos están calculados en base a una presión de aire de entrada de 6 Bares
 Pneumatic actuators are calculated based on an inlet air pressure of 6 Bar

5144
5325144
 ACTUADOR
 ELÉCTRICO
 BAJO VOLTAJE
 ELECTRIC
 ACTUATOR
 LOW VOLTAGE



Válvula de mariposa tipo
 lug disco inoxidable asiento
 blando NBR con actuador
 Butterfly valve lug type
 stainless steel disc NBR
 soft seat with actuator

5325144-050	5324020	325	169	181	110	2"
5325144-065	5324035	337	169	181	110	2 1/2"
5325144-080	5324055	372	196	181	110	3"
5325144-100	5324085	389	196	181	128	4"
5325144-125	5324140	447	254	235	214	5"
5325144-150	5324140	458	254	235	214	6"
5325144-200	5324300	521	254	235	214	8"

- 12V VAC/VDC
- Para diámetros superiores consultar disponibilidad. Larger diameters under request

5144
5305144
 ACTUADOR
 ELÉCTRICO
 ALTO VOLTAJE
 ELECTRIC
 ACTUATOR
 HIGH VOLTAGE



Válvula de mariposa tipo
 lug disco inoxidable asiento
 blando NBR con actuador
 Butterfly valve lug type
 stainless steel disc NBR
 soft seat with actuator

5305144-050	5300020	325	169	181	110	2"
5305144-065	5300035	337	169	181	110	2 1/2"
5305144-080	5300055	372	196	181	110	3"
5305144-100	5300085	389	196	181	128	4"
5305144-125	5300140	447	254	235	214	5"
5305144-150	5300140	458	254	235	214	6"
5305144-200	5300300	521	254	235	214	8"

- 24V-240V VAC/VDC
- Para diámetros superiores consultar disponibilidad. Larger diameters under request

Para temperaturas superiores a 70°C se debe montar un puente separador entre la válvula y el actuador.
 At temperatures above 70°C separating bridge must be mounted between the valve and the actuator.

CÓDIGO CODE
 ACTUADOR ACTUATOR
 H ALTURA DESDE EJE DE VÁLVULA A PARTE SUPERIOR DEL ACTUADOR
 HIGH FROM VALVE AXIS TO ACTUATOR TOP
 F ALTURA DEL ACTUADOR ACTUATOR HIGH
 A LONGITUD DEL ACTUADOR ACTUATOR LENGTH
 G GROSOR DEL ACTUADOR ACTUATOR THICKNESS
 MEDIDA SIZE

51442
51051442
 SIMPLE EFECTO
 SIMPLE RETURN
 ACTUATOR

NEW



Válvula de mariposa tipo
 lug disco inoxidable asiento
 blando EPDM con actuador
 Butterfly valve lug type
 stainless steel disc EPDM
 soft seat with actuator

ATEX 

51051442-050	5100075	276	120	201	94	2"
51051442-065	5100083	296	128	209	101	2 1/2"
51051442-080	5100092	316	140	242	108,5	3"
51051442-100	5100105	346	153	275	122	4"
51051442-125	5100125	383	175	332	137,5	5"
51051442-150	5100140	415,5	191,5	385	153	6"
51051442-200	5100140	458,5	191,5	385	153	8"

- Actuadores neumáticos ATEX. Para diámetros superiores consultar disponibilidad
 Pneumatic actuators ATEX. Larger diameters under request
- Los actuadores neumáticos están calculados en base a una presión de aire de entrada de 6 Bares
 Pneumatic actuators are calculated based on a inlet air pressure of 6 Bar

51442
52051442
 DOBLE EFECTO
 DOUBLE ACTING
 ACTUATOR

NEW



Válvula de mariposa tipo
 lug disco inoxidable asiento
 blando EPDM con actuador
 Butterfly valve lug type
 stainless steel disc EPDM
 soft seat with actuator

ATEX 

52051442-050	5200052	248	92	145	71	2"
52051442-065	5200063	276	108	169	82	2 1/2"
52051442-080	5200075	296	120	201	94	3"
52051442-100	5200075	313	120	201	94	4"
52051442-125	5200092	348	140	242	108,5	5"
52051442-150	5200092	359	140	242	108,5	6"
52051442-200	5200105	420	153	275	122	8"

- Actuadores neumáticos ATEX. Para diámetros superiores consultar disponibilidad
 Pneumatic actuators ATEX. Larger diameters under request
- Los actuadores neumáticos están calculados en base a una presión de aire de entrada de 6 Bares
 Pneumatic actuators are calculated based on a inlet air pressure of 6 Bar

51442
53251442
 ACTUADOR
 ELÉCTRICO
 BAJO VOLTAJE
 ELECTRIC
 ACTUATOR
 LOW VOLTAGE

NEW



Válvula de mariposa tipo
 lug disco inoxidable asiento
 blando EPDM con actuador
 Butterfly valve lug type
 stainless steel disc EPDM
 soft seat with actuator

53251442-050	5324020	325	169	181	110	2"
53251442-065	5324035	337	169	181	110	2 1/2"
53251442-080	5324055	372	196	181	110	3"
53251442-100	5324085	389	196	181	128	4"
53251442-125	5324140	447	254	235	214	5"
53251442-150	5324140	458	254	235	214	6"
53251442-200	5324300	521	254	235	214	8"

- 12V VAC/VDC
- Para diámetros superiores consultar disponibilidad. Larger diameters under request

51442
53051442
 ACTUADOR
 ELÉCTRICO
 ALTO VOLTAJE
 ELECTRIC
 ACTUATOR
 HIGH VOLTAGE

NEW



Válvula de mariposa tipo
 lug disco inoxidable asiento
 blando EPDM con actuador
 Butterfly valve lug type
 stainless steel disc EPDM
 soft seat with actuator

53051442-050	5300020	325	169	181	110	2"
53051442-065	5300035	337	169	181	110	2 1/2"
53051442-080	5300055	372	196	181	110	3"
53051442-100	5300085	389	196	181	128	4"
53051442-125	5300140	447	254	235	214	5"
53051442-150	5300140	458	254	235	214	6"
53051442-200	5300300	521	254	235	214	8"

- 24V-240V VAC/VDC
- Para diámetros superiores consultar disponibilidad. Larger diameters under request

Para temperaturas superiores a 70°C se debe montar un puente separador entre la válvula y el actuador.
 At temperatures above 70°C separating bridge must be mounted between the valve and the actuator.

CÓDIGO CODE
 ACTUADOR ACTUATOR
H ALTURA DESDE EJE DE VÁLVULA A PARTE SUPERIOR DEL ACTUADOR
 HIGH FROM VALVE AXIS TO ACTUATOR TOP
F ALTURA DEL ACTUADOR ACTUATOR HIGH
A LONGITUD DEL ACTUADOR ACTUATOR LONGITUDE
G GROSOR DEL ACTUADOR ACTUATOR THICKNESS
 MEDIDA SIZE

51143
51051143
 SIMPLE EFECTO
 SIMPLE RETURN
 ACTUATOR



Válvula de mariposa tipo wafer disco y asiento PTFE con actuador
 Butterfly valve wafer type PTFE disc and seat with actuator



51051143-050	5100083	279	128	209	101	2"
51051143-065	5100083	283	128	209	101	2 1/2"
51051143-080	5100092	295	140	242	108,5	3"
51051143-100	5100105	326	153	275	122	4"
51051143-125	5100125	360	175	332	137,5	5"
51051143-150	5100140	401,5	191,5	385	153	6"
51051143-200	5100160	469	217	450	174	8"
51051143-250	-	-	-	-	-	10"
51051143-300	-	-	-	-	-	12"

- Actuadores neumáticos ATEX. Para diámetros superiores consultar disponibilidad
Pneumatic actuators ATEX. Larger diameters under request
- Los actuadores neumáticos están calculados en base a una presión de aire de entrada de 6 Bares
Pneumatic actuators are calculated based on a inlet air pressure of 6 Bar

51143
52051143
 DOBLE EFECTO
 DOUBLE ACTING
 ACTUATOR



Válvula de mariposa tipo wafer disco y asiento PTFE con actuador
 Butterfly valve wafer type PTFE disc and seat with actuator



52051143-050	5200063	259	108	169	82	2"
52051143-065	5200063	263	108	169	82	2 1/2"
52051143-080	5200075	275	120	201	94	3"
52051143-100	5200083	301	128	209	101	4"
52051143-125	5200092	325	140	242	108,5	5"
52051143-150	5200105	343	153	275	122	6"
52051143-200	5200125	427	175	332	137,5	8"
52051143-250	-	-	-	-	-	10"
52051143-300	-	-	-	-	-	12"

- Actuadores neumáticos ATEX. Para diámetros superiores consultar disponibilidad
Pneumatic actuators ATEX. Larger diameters under request
- Los actuadores neumáticos están calculados en base a una presión de aire de entrada de 6 Bares
Pneumatic actuators are calculated based on a inlet air pressure of 6 Bar

51143
53251143
 ACTUADOR ELÉCTRICO BAJO VOLTAJE
 ELECTRIC ACTUATOR LOW VOLTAGE



Válvula de mariposa tipo wafer disco y asiento PTFE con actuador
 Butterfly valve wafer type PTFE disc and seat with actuator

53251143-050	5324035	325	169	181	110	2"
53251143-065	5324035	337	169	181	110	2 1/2"
53251143-080	5324055	372	196	181	110	3"
53251143-100	5324085	389	196	181	128	4"
53251143-125	5324140	447	254	235	214	5"
53251143-150	5324140	458	254	235	214	6"
53251143-200	5324300	521	254	235	214	8"

- 12V VAC/VDC
- Para diámetros superiores consultar disponibilidad. Larger diameters under request

51143
53051143
 ACTUADOR ELÉCTRICO ALTO VOLTAJE
 ELECTRIC ACTUATOR HIGH VOLTAGE



Válvula de mariposa tipo wafer disco y asiento PTFE con actuador
 Butterfly valve wafer type PTFE disc and seat with actuator

53051143-050	5300035	325	169	181	110	2"
53051143-065	5300035	337	169	181	110	2 1/2"
53051143-080	5300055	372	196	181	110	3"
53051143-100	5300085	389	196	181	128	4"
53051143-125	5300140	447	254	235	214	5"
53051143-150	5300140	458	254	235	214	6"
53051143-200	5300300	521	254	235	214	8"

- 24V-240V VAC/VDC
- Para diámetros superiores consultar disponibilidad. Larger diameters under request

Para temperaturas superiores a 70°C se debe montar un puente separador entre la válvula y el actuador.
 At temperatures above 70°C separating bridge must be mounted between the valve and the actuator.

CÓDIGO CODE
 ACTUADOR ACTUATOR
 H ALTURA DESDE EJE DE VÁLVULA A PARTE SUPERIOR DEL ACTUADOR
 HIGH FROM VALVE AXIS TO ACTUATOR TOP
 F ALTURA DEL ACTUADOR ACTUATOR HIGH
 A LONGITUD DEL ACTUADOR ACTUATOR LENGTH
 G GROSOR DEL ACTUADOR ACTUATOR THICKNESS
 MEDIDA SIZE

0917
5100917
 SIMPLE EFECTO
 SIMPLE RETURN
 ACTUATOR



Válvula esfera dos piezas
 roscar con pletina ISO y
 actuador
 Two pieces ball valve full
 bore threaded end ISO
 mounting pad with actuator
ATEX

5100917-008	5100052	128,5	92	145	71	1/4"
5100917-010	5100052	129	92	145	71	3/8"
5100917-015	5100052	131	92	145	71	1/2"
5100917-020	5100052	133,5	92	145	71	3/4"
5100917-025	5100063	155	108	169	82	1"
5100917-032	5100075	172	120	201	94	1 1/4"
5100917-040	5100083	190	128	209	101	1 1/2"
5100917-050	5100092	211	140	242	108,5	2"

- Actuadores neumáticos ATEX
Pneumatic actuators ATEX
- Los actuadores neumáticos están calculados en base a una presión de aire de entrada de 6 Bares
Pneumatic actuators are calculated based on an inlet air pressure of 6 Bar

0917
5200917
 DOBLE EFECTO
 DOUBLE ACTING
 ACTUATOR



Válvula esfera dos piezas
 roscar con pletina ISO y
 actuador
 Two pieces ball valve full
 bore threaded end ISO
 mounting pad with actuator
ATEX

5200917-008	5200052	128,5	92	145	71	1/4"
5200917-010	5200052	129	92	145	71	3/8"
5200917-015	5200052	131	92	145	71	1/2"
5200917-020	5200052	133,5	92	145	71	3/4"
5200917-025	5200052	139	92	145	71	1"
5200917-032	5200063	160	108	169	82	1 1/4"
5200917-040	5200075	182	120	201	94	1 1/2"
5200917-050	5200075	191	120	201	94	2"

- Actuadores neumáticos ATEX
Pneumatic actuators ATEX
- Los actuadores neumáticos están calculados en base a una presión de aire de entrada de 6 Bares
Pneumatic actuators are calculated based on an inlet air pressure of 6 Bar

0917
5320917
 ACTUADOR
 ELÉCTRICO
 BAJO VOLTAJE
 ELECTRIC
 ACTUATOR
 LOW VOLTAGE



Válvula esfera dos piezas
 roscar con pletina ISO y
 actuador
 Two pieces ball valve full
 bore threaded end ISO
 mounting pad with actuator

5320917-008**	5324010	160,5	124	169	104	1/4"
5320917-010**	5324010	161	124	169	104	3/8"
5320917-015**	5324010	163	124	169	104	1/2"
5320917-020*	5324020	210,5	169	181	110	3/4"
5320917-025*	5324020	216	169	181	110	1"
5320917-032*	5324035	221	169	181	110	1 1/4"
5320917-040*	5324035	231	169	181	110	1 1/2"
5320917-050*	5324055	267	196	181	110	2"

- *12V VAC/VDC **24V VAC/VDC

0917
5300917
 ACTUADOR
 ELÉCTRICO
 ALTO VOLTAJE
 ELECTRIC
 ACTUATOR
 HIGH VOLTAGE



Válvula esfera dos piezas
 roscar con pletina ISO y
 actuador
 Two pieces ball valve full
 bore threaded end ISO
 mounting pad with actuator

5300917-008**	5300010	160,5	124	169	104	1/4"
5300917-010**	5300010	161	124	169	104	3/8"
5300917-015**	5300010	163	124	169	104	1/2"
5300917-020*	5300020	211	169	181	110	3/4"
5300917-025*	5300020	216	169	181	110	1"
5300917-032*	5300035	221	169	181	110	1 1/4"
5300917-040*	5300035	231	169	181	110	1 1/2"
5300917-050*	5300055	267	196	181	110	2"

- *24V-240V VAC/VDC ** 85V VAC/VDC

Para temperaturas superiores a 70°C se debe montar un puente separador entre la válvula y el actuador.
 At temperatures above 70°C separating bridge must be mounted between the valve and the actuator.

CÓDIGO CODE
 ACTUADOR ACTUATOR
H ALTURA DESDE EJE DE VÁLVULA A PARTE SUPERIOR DEL ACTUADOR
 HIGH FROM VALVE AXIS TO ACTUATOR TOP
F ALTURA DEL ACTUADOR ACTUATOR HIGH
A LONGITUD DEL ACTUADOR ACTUATOR LENGTH
G GROSOR DEL ACTUADOR ACTUATOR THICKNESS
 MEDIDA SIZE

0918
5100918
 SIMPLE EFECTO
 SIMPLE RETURN
 ACTUATOR



Válvula esfera tres vías
 paso en L con pletina ISO y
 actuador
 Three way ball valve L-type
 full bore ISO mounting pad
 with actuator



5100918-008	5100052	134	92	145	71	1/4"
5100918-010	5100052	134	92	145	71	3/8"
5100918-015	5100052	134	92	145	71	1/2"
5100918-020	5100063	157	108	169	82	3/4"
5100918-025	5100063	168	108	169	82	1"
5100918-032	5100083	191	128	209	101	1 1/4"
5100918-040	5100083	202	128	209	101	1 1/2"
5100918-050	5100092	223	140	242	108,5	2"

- Actuadores neumáticos ATEX
Pneumatic actuators ATEX
- Los actuadores neumáticos están calculados en base a una presión de aire de entrada de 6 Bares
Pneumatic actuators are calculated based on an inlet air pressure of 6 Bar

0918
5200918
 DOBLE EFECTO
 DOUBLE ACTING
 ACTUATOR



Válvula esfera tres vías
 paso en L con pletina ISO y
 actuador
 Three way ball valve L-type
 full bore ISO mounting pad
 with actuator



5200918-008	5200052	134	92	145	71	1/4"
5200918-010	5200052	134	92	145	71	3/8"
5200918-015	5200052	134	92	145	71	1/2"
5200918-020	5200052	141	92	145	71	3/4"
5200918-025	5200052	152	92	145	71	1"
5200918-032	5200063	171	108	169	82	1 1/4"
5200918-040	5200063	182	108	169	82	1 1/2"
5200918-050	5200075	203	120	201	94	2"

- Actuadores neumáticos ATEX
Pneumatic actuators ATEX
- Los actuadores neumáticos están calculados en base a una presión de aire de entrada de 6 Bares
Pneumatic actuators are calculated based on an inlet air pressure of 6 Bar

0918
5320918
 ACTUADOR
 ELÉCTRICO
 BAJO VOLTAJE
 ELECTRIC
 ACTUATOR
 LOW VOLTAGE



Válvula esfera tres vías
 paso en L con pletina ISO y
 actuador
 Three way ball valve L-type
 full bore ISO mounting pad
 with actuator

5320918-008	5324020	211	169	181	110	1/4"
5320918-010	5324020	211	169	181	110	3/8"
5320918-015	5324020	211	169	181	110	1/2"
5320918-020	5324020	218	169	181	110	3/4"
5320918-025	5324020	229	169	181	110	1"
5320918-032	5324035	232	169	181	110	1 1/4"
5320918-040	5324055	243	169	181	110	1 1/2"
5320918-050	5324085	279	196	181	128	2"

- 12V VAC/VDC

0918
5300918
 ACTUADOR
 ELÉCTRICO
 ALTO VOLTAJE
 ELECTRIC
 ACTUATOR
 HIGH VOLTAGE



Válvula esfera tres vías
 paso en L con pletina ISO y
 actuador
 Three way ball valve L-type
 full bore ISO mounting pad
 with actuator

5300918-008	5300020	211	169	181	110	1/4"
5300918-010	5300020	211	169	181	110	3/8"
5300918-015	5300020	211	169	181	110	1/2"
5300918-020	5300020	218	169	181	110	3/4"
5300918-025	5300020	229	169	181	110	1"
5300918-032	5300035	232	169	181	110	1 1/4"
5300918-040	5300055	243	169	181	110	1 1/2"
5300918-050	5300085	279	196	181	128	2"

- 24V-240V VAC/VDC

Para temperaturas superiores a 70°C se debe montar un puente separador entre la válvula y el actuador.
 At temperatures above 70°C separating bridge must be mounted between the valve and the actuator.

CÓDIGO CODE
 ACTUADOR ACTUATOR
H ALTURA DESDE EJE DE VÁLVULA A PARTE SUPERIOR DEL ACTUADOR
 HIGH FROM VALVE AXIS TO ACTUATOR TOP
F ALTURA DEL ACTUADOR ACTUATOR HIGH
A LONGITUD DEL ACTUADOR ACTUATOR LENGTH
G GROSOR DEL ACTUADOR ACTUATOR THICKNESS
 MEDIDA SIZE

0919
5100919
 SIMPLE EFECTO
 SIMPLE RETURN
 ACTUATOR



Válvula esfera tres vías
 paso en T con pletina ISO y
 actuador
 Three way ball valve T-type
 full bore ISO mounting pad
 with actuator



5100919-008	5100052	134	92	145	71	1/4"
5100919-010	5100052	134	92	145	71	3/8"
5100919-015	5100052	134	92	145	71	1/2"
5100919-020	5100063	157	108	169	82	3/4"
5100919-025	5100063	168	108	169	82	1"
5100919-032	5100083	191	128	209	101	1 1/4"
5100919-040	5100083	202	128	209	101	1 1/2"
5100919-050	5100092	223	140	242	108,5	2"

- Actuadores neumáticos ATEX
Pneumatic actuators ATEX
- Los actuadores neumáticos están calculados en base a una presión de aire de entrada de 6 Bares
Pneumatic actuators are calculated based on an inlet air pressure of 6 Bar

0919
5200919
 DOBLE EFECTO
 DOUBLE ACTING
 ACTUATOR



Válvula esfera tres vías
 paso en T con pletina ISO y
 actuador
 Three way ball valve T-type
 full bore ISO mounting pad
 with actuator



5200919-008	5200052	134	92	145	71	1/4"
5200919-010	5200052	134	92	145	71	3/8"
5200919-015	5200052	134	92	145	71	1/2"
5200919-020	5200052	141	92	145	71	3/4"
5200919-025	5200052	152	92	145	71	1"
5200919-032	5200063	171	108	169	82	1 1/4"
5200919-040	5200063	182	108	169	82	1 1/2"
5200919-050	5200075	203	120	201	94	2"

- Actuadores neumáticos ATEX
Pneumatic actuators ATEX
- Los actuadores neumáticos están calculados en base a una presión de aire de entrada de 6 Bares
Pneumatic actuators are calculated based on an inlet air pressure of 6 Bar

0919
5320919
 ACTUADOR
 ELÉCTRICO
 BAJO VOLTAJE
 ELECTRIC
 ACTUATOR
 LOW VOLTAGE



Válvula esfera tres vías
 paso en T con pletina ISO y
 actuador
 Three way ball valve T-type
 full bore ISO mounting pad
 with actuator

5320919-008	5324020	211	169	181	110	1/4"
5320919-010	5324020	211	169	181	110	3/8"
5320919-015	5324020	211	169	181	110	1/2"
5320919-020	5324020	218	169	181	110	3/4"
5320919-025	5324020	229	169	181	110	1"
5320919-032	5324035	232	169	181	110	1 1/4"
5320919-040	5324055	243	169	181	110	1 1/2"
5320919-050	5324085	279	196	181	128	2"

- 12V VAC/VDC

0919
5300919
 ACTUADOR
 ELÉCTRICO
 ALTO VOLTAJE
 ELECTRIC
 ACTUATOR
 HIGH VOLTAGE



Válvula esfera tres vías
 paso en T con pletina ISO y
 actuador
 Three way ball valve T-type
 full bore ISO mounting pad
 with actuator

5300919-008	5300020	211	169	181	110	1/4"
5300919-010	5300020	211	169	181	110	3/8"
5300919-015	5300020	211	169	181	110	1/2"
5300919-020	5300020	218	169	181	110	3/4"
5300919-025	5300020	229	169	181	110	1"
5300919-032	5300035	232	169	181	110	1 1/4"
5300919-040	5300055	243	169	181	110	1 1/2"
5300919-050	5300085	279	196	181	128	2"

- 24V-240V VAC/VDC

Para temperaturas superiores a 70°C se debe montar un puente separador entre la válvula y el actuador.
 At temperatures above 70°C separating bridge must be mounted between the valve and the actuator.

CÓDIGO CODE
 ACTUADOR ACTUATOR
H ALTURA DESDE EJE DE VÁLVULA A PARTE SUPERIOR DEL ACTUADOR
 HIGH FROM VALVE AXIS TO ACTUATOR TOP
F ALTURA DEL ACTUADOR ACTUATOR HIGH
A LONGITUD DEL ACTUADOR ACTUATOR LONGITUDE
G GROSOR DEL ACTUADOR ACTUATOR THICKNESS
 MEDIDA SIZE

5117
5105117
 SIMPLE EFECTO
 SIMPLE RETURN
 ACTUATOR



Válvula esfera dos piezas
 acero al carbono bola
 A-316 brida con actuador
 Two pieces ball valves
 WCB flanged end with
 actuador



5105117-015	5100052	141	92	145	71	1/2"
5105117-020	5100052	146	92	145	71	3/4"
5105117-025	5100063	167	108	169	82	1"
5105117-032	5100075	191	120	201	94	1 1/4"
5105117-040	5100083	206	128	209	101	1 1/2"
5105117-050	5100092	225	140	242	108,5	2"
5105117-065	5100105	253	153	275	122	2 1/2"
5105117-080	5100125	285	175	332	137,5	3"
5105117-100	5100160	347	217	450	174	4"
5105117-125	5100190	445	260	507	206	5"
5105117-150	5100210	485	285	562	226	6"
5105117-200	-	-	-	-	-	8"

- Actuadores neumáticos ATEX
Pneumatic actuators ATEX
- Los actuadores neumáticos están calculados en base a una presión de aire de entrada de 6 Bares
Pneumatic actuators are calculated based on an inlet air pressure of 6 Bar

5117
5205117
 DOBLE EFECTO
 DOUBLE ACTING
 ACTUATOR



Válvula esfera dos piezas
 acero al carbono bola
 A-316 brida con actuador
 Two pieces ball valves
 WCB flanged end with
 actuador



5205117-015	5200052	141	92	145	71	1/2"
5205117-020	5200052	146	92	145	71	3/4"
5205117-025	5200052	151	92	145	71	1"
5205117-032	5200052	163	92	145	71	1 1/4"
5205117-040	5200063	186	108	169	82	1 1/2"
5205117-050	5200075	205	120	201	94	2"
5205117-065	5200083	228	128	209	101	2 1/2"
5205117-080	5200092	250	140	242	108,5	3"
5205117-100	5200125	305	175	332	137,5	4"
5205117-125	5200140	356,5	191,5	385	153	5"
5205117-150	5200160	397	217	450	174	6"
5205117-200	-	-	-	-	-	8"

- Actuadores neumáticos ATEX
Pneumatic actuators ATEX
- Los actuadores neumáticos están calculados en base a una presión de aire de entrada de 6 Bares
Pneumatic actuators are calculated based on an inlet air pressure of 6 Bar

5117
5325117
 ACTUADOR
 ELÉCTRICO
 BAJO VOLTAJE
 ELECTRIC
 ACTUATOR
 LOW VOLTAGE



Válvula esfera dos piezas
 acero al carbono bola
 A-316 brida con actuador
 Two pieces ball valves
 WCB flanged end with
 actuador

5325117-015**	5324010	173	124	169	104	1/2"
5325117-020**	5324010	178	124	169	104	3/4"
5325117-025*	5324020	228	169	181	110	1"
5325117-032*	5324035	240	169	181	110	1 1/4"
5325117-040*	5324035	247	169	181	110	1 1/2"
5325117-050*	5324055	281	196	181	110	2"
5325117-065*	5324085	296	196	181	128	2 1/2"
5325117-080*	5324140	364	254	235	214	3"
5325117-100*	5324300	384	254	235	214	4"

- *12V VAC/VDC **24V VAC/VDC

5117
5305117
 ACTUADOR
 ELÉCTRICO
 ALTO VOLTAJE
 ELECTRIC
 ACTUATOR
 HIGH VOLTAGE



Válvula esfera dos piezas
 acero al carbono bola
 A-316 brida con actuador
 Two pieces ball valves
 WCB flanged end with
 actuador

5305117-015**	5300010	173	124	169	104	1/2"
5305117-020**	5300010	178	124	169	104	3/4"
5305117-025*	5300020	228	169	181	110	1"
5305117-032*	5300035	240	169	181	110	1 1/4"
5305117-040*	5300035	247	169	181	110	1 1/2"
5305117-050*	5300055	281	196	181	110	2"
5305117-065*	5300085	296	196	181	128	2 1/2"
5305117-080*	5300140	364	254	235	214	3"
5305117-100*	5300300	384	254	235	214	4"

- *24V-240V VAC/VDC ** 85V VAC/VDC

Para temperaturas superiores a 70°C se debe montar un puente separador entre la válvula y el actuador.
 At temperatures above 70°C separating bridge must be mounted between the valve and the actuator.

CÓDIGO CODE
 ACTUADOR ACTUATOR
 H ALTURA DESDE EJE DE VÁLVULA A PARTE SUPERIOR DEL ACTUADOR
 HIGH FROM VALVE AXIS TO ACTUATOR TOP
 F ALTURA DEL ACTUADOR ACTUATOR HIGH
 A LONGITUD DEL ACTUADOR ACTUATOR LONGITUDE
 G GROSOR DEL ACTUADOR ACTUATOR THICKNESS
 MEDIDA SIZE

5128
5105128
 SIMPLE EFECTO
 SIMPLE RETURN
 ACTUATOR



Válvula esfera dos piezas
 inoxidable brida actuada
 Two pieces ball valve
 stainless steel flanged end
 with actuator



5105128-015	5100052	141	92	145	71	1/2"
5105128-020	5100052	146	92	145	71	3/4"
5105128-025	5100063	167	108	169	82	1"
5105128-032	5100075	191	120	201	94	1 1/4"
5105128-040	5100083	206	128	209	101	1 1/2"
5105128-050	5100092	225	140	242	108,5	2"
5105128-065	5100105	253	153	275	122	2 1/2"
5105128-080	5100125	285	175	332	137,5	3"
5105128-100	5100140	321,5	191,5	385	153	4"
5105128-125	5100160	382	217	450	174	5"
5105128-150	5100210	485	285	562	226	6"

- Actuadores neumáticos ATEX
Pneumatic actuators ATEX
- Los actuadores neumáticos están calculados en base a una presión de aire de entrada de 6 Bares
Pneumatic actuators are calculated based on a inlet air pressure of 6 Bar

5128
5205128
 DOBLE EFECTO
 DOUBLE ACTING
 ACTUATOR



Válvula esfera dos piezas
 inoxidable brida actuada
 Two pieces ball valve
 stainless steel flanged end
 with actuator



5205128-015	5200052	141	92	145	71	1/2"
5205128-020	5200052	146	92	145	71	3/4"
5205128-025	5200052	151	92	145	71	1"
5205128-032	5200052	163	92	145	71	1 1/4"
5205128-040	5200063	186	108	169	82	1 1/2"
5205128-050	5200075	205	120	201	94	2"
5205128-065	5200083	228	128	209	101	2 1/2"
5205128-080	5200092	250	140	242	108,5	3"
5205128-100	5200125	305	175	332	137,5	4"
5205128-125	5200140	356,5	191,5	385	153	5"
5205128-150	5200160	397	217	450	174	6"

- Actuadores neumáticos ATEX
Pneumatic actuators ATEX
- Los actuadores neumáticos están calculados en base a una presión de aire de entrada de 6 Bares
Pneumatic actuators are calculated based on a inlet air pressure of 6 Bar

5128
5325128
 ACTUADOR
 ELÉCTRICO
 BAJO VOLTAJE
 ELECTRIC
 ACTUATOR
 LOW VOLTAGE



Válvula esfera dos piezas
 inoxidable brida actuada
 Two pieces ball valve
 stainless steel flanged end
 with actuator

5325128-015**	5324010	173	124	169	104	1/2"
5325128-020**	5324010	178	124	169	104	3/4"
5325128-025*	5324020	228	169	181	110	1"
5325128-032*	5324035	240	169	181	110	1 1/4"
5325128-040*	5324035	247	169	181	110	1 1/2"
5325128-050*	5324055	281	196	181	110	2"
5325128-065*	5324085	296	196	181	128	2 1/2"
5325128-080*	5324140	364	254	235	214	3"
5325128-100*	5324140	384	254	235	214	4"

- *12V VAC/VDC **24V VAC/VDC

5128
5305128
 ACTUADOR
 ELÉCTRICO
 ALTO VOLTAJE
 ELECTRIC
 ACTUATOR
 HIGH VOLTAGE



Válvula esfera dos piezas
 inoxidable brida actuada
 Two pieces ball valve
 stainless steel flanged end
 with actuator

5305128-015**	5300010	173	124	169	104	1/2"
5305128-020**	5300010	178	124	169	104	3/4"
5305128-025*	5300020	228	169	181	110	1"
5305128-032*	5300035	240	169	181	110	1 1/4"
5305128-040*	5300035	247	169	181	110	1 1/2"
5305128-050*	5300055	281	196	181	110	2"
5305128-065*	5300085	296	196	181	128	2 1/2"
5305128-080*	5300140	364	254	235	214	3"
5305128-100*	5300140	384	254	235	214	4"

- *24V-240V VAC/VDC ** 85V VAC/VDC

Para temperaturas superiores a 70°C se debe montar un puente separador entre la válvula y el actuador.
 At temperatures above 70°C separating bridge must be mounted between the valve and the actuator.

CÓDIGO CODE
 ACTUADOR ACTUATOR
H ALTURA DESDE EJE DE VÁLVULA A PARTE SUPERIOR DEL ACTUADOR
 HIGH FROM VALVE AXIS TO ACTUATOR TOP
F ALTURA DEL ACTUADOR ACTUATOR HIGH
A LONGITUD DEL ACTUADOR ACTUATOR LONGITUDE
G GROSOR DEL ACTUADOR ACTUATOR THICKNESS
 MEDIDA SIZE

91120
51091120
 SIMPLE EFECTO
 SIMPLE RETURN
 ACTUATOR



Válvula esfera tres piezas
 Socked Weld paso total
 con pletina ISO y actuador
 Three pieces ball valve
 Socked Weld full bore ISO
 mounting pad with actuator



51091120-015	5100052	131	92	145	71	1/2"
51091120-020	5100052	133,5	92	145	71	3/4"
51091120-025	5100063	155	108	169	82	1"
51091120-032	5100063	160	108	169	82	1 1/4"
51091120-040	5100075	182	120	201	94	1 1/2"
51091120-050	5100083	199	128	209	101	2"
51091120-065	5100092	229	140	242	108,5	2 1/2"
51091120-080	5100105	-	-	-	-	3"
51091120-100	5100140	-	-	-	-	4"

- Actuadores neumáticos ATEX
Pneumatic actuators ATEX
- Los actuadores neumáticos están calculados en base a una presión de aire de entrada de 6 Bares
Pneumatic actuators are calculated based on an inlet air pressure of 6 Bar

91120
52091120
 DOBLE EFECTO
 DOUBLE ACTING
 ACTUATOR



Válvula esfera tres piezas
 Socked Weld paso total
 con pletina ISO y actuador
 Three pieces ball valve
 Socked Weld full bore ISO
 mounting pad with actuator



52091120-015	5200052	131	92	145	71	1/2"
52091120-020	5200052	133,5	92	145	71	3/4"
52091120-025	5200052	139	92	145	71	1"
52091120-032	5200052	144	92	145	71	1 1/4"
52091120-040	5200063	170	108	169	82	1 1/2"
52091120-050	5200063	179	108	169	82	2"
52091120-065	5200083	217	128	209	101	2 1/2"
52091120-080	5200083	-	-	-	-	3"
52091120-100	5200125	-	-	-	-	4"

- Actuadores neumáticos ATEX
Pneumatic actuators ATEX
- Los actuadores neumáticos están calculados en base a una presión de aire de entrada de 6 Bares
Pneumatic actuators are calculated based on an inlet air pressure of 6 Bar

91120
53291120
 ACTUADOR
 ELÉCTRICO
 BAJO VOLTAJE
 ELECTRIC
 ACTUATOR
 LOW VOLTAGE



Válvula esfera tres piezas
 Socked Weld paso total
 con pletina ISO y actuador
 Three pieces ball valve
 Socked Weld full bore ISO
 mounting pad with actuator

53291120-015**	5324010	163	124	169	104	1/2"
53291120-020*	5324020	210,5	169	181	110	3/4"
53291120-025*	5324020	216	169	181	110	1"
53291120-032*	5324035	221	169	181	110	1 1/4"
53291120-040*	5324035	231	169	181	110	1 1/2"
53291120-050*	5324055	267	196	181	110	2"
53291120-065*	5324055	285	196	181	110	2 1/2"
53291120-080*	5324085	-	-	-	-	3"
53291120-100*	5324140	-	-	-	-	4"

- *12V VAC/VDC **24V VAC/VDC

91120
53091120
 ACTUADOR
 ELÉCTRICO
 ALTO VOLTAJE
 ELECTRIC
 ACTUATOR
 HIGH VOLTAGE



Válvula esfera tres piezas
 Socked Weld paso total
 con pletina ISO y actuador
 Three pieces ball valve
 Socked Weld full bore ISO
 mounting pad with actuator

53091120-015**	5300010	163	124	169	104	1/2"
53091120-020*	5300020	210,5	169	181	110	3/4"
53091120-025*	5300020	216	169	181	110	1"
53091120-032*	5300035	221	169	181	110	1 1/4"
53091120-040*	5300035	231	169	181	110	1 1/2"
53091120-050*	5300055	267	196	181	110	2"
53091120-065*	5300055	285	196	181	110	2 1/2"
53091120-080*	5300085	-	-	-	-	3"
53091120-100*	5300140	-	-	-	-	4"

- *24V-240V VAC/VDC ** 85V VAC/VDC

Para temperaturas superiores a 70°C se debe montar un puente separador entre la válvula y el actuador.
 At temperatures above 70°C separating bridge must be mounted between the valve and the actuator.

CÓDIGO CODE
 ACTUADOR ACTUATOR
H ALTURA DESDE EJE DE VÁLVULA A PARTE SUPERIOR DEL ACTUADOR
 HIGH FROM VALVE AXIS TO ACTUATOR TOP
F ALTURA DEL ACTUADOR ACTUATOR HIGH
A LONGITUD DEL ACTUADOR ACTUATOR LONGITUDE
G GROSOR DEL ACTUADOR ACTUATOR THICKNESS
 MEDIDA SIZE

91020
51091020
 SIMPLE EFECTO
 SIMPLE RETURN
 ACTUATOR



Válvula esfera tres piezas
 Butt Weld paso total con
 pletina ISO y actuador
 Three pieces ball valve Butt
 Weld full bore ISO mount-
 ing pad with actuator



51091020-015	5100052	131	92	145	71	1/2"
51091020-020	5100052	133,5	92	145	71	3/4"
51091020-025	5100063	155	108	169	82	1"
51091020-032	5100063	160	108	169	82	1 1/4"
51091020-040	5100075	182	120	201	94	1 1/2"
51091020-050	5100083	199	128	209	101	2"
51091020-065	5100092	229	140	242	108,5	2 1/2"
51091020-080	5100105	-	-	-	-	3"
51091020-100	5100140	-	-	-	-	4"

- Actuadores neumáticos ATEX
Pneumatic actuators ATEX
- Los actuadores neumáticos están calculados en base a una presión de aire de entrada de 6 Bares
Pneumatic actuators are calculated based on an inlet air pressure of 6 Bar

91020
52091020
 DOBLE EFECTO
 DOUBLE ACTING
 ACTUATOR



Válvula esfera tres piezas
 Butt Weld paso total con
 pletina ISO y actuador
 Three pieces ball valve Butt
 Weld full bore ISO mount-
 ing pad with actuator



52091020-015	5200052	131	92	145	71	1/2"
52091020-020	5200052	133,5	92	145	71	3/4"
52091020-025	5200052	139	92	145	71	1"
52091020-032	5200052	144	92	145	71	1 1/4"
52091020-040	5200063	170	108	169	82	1 1/2"
52091020-050	5200063	179	108	169	82	2"
52091020-065	5200083	217	128	209	101	2 1/2"
52091020-080	5200083	-	-	-	-	3"
52091020-100	5200125	-	-	-	-	4"

- Actuadores neumáticos ATEX
Pneumatic actuators ATEX
- Los actuadores neumáticos están calculados en base a una presión de aire de entrada de 6 Bares
Pneumatic actuators are calculated based on an inlet air pressure of 6 Bar

91020
53291020
 ACTUADOR
 ELÉCTRICO
 BAJO VOLTAJE
 ELECTRIC
 ACTUATOR
 LOW VOLTAGE



Válvula esfera tres piezas
 Butt Weld paso total con
 pletina ISO y actuador
 Three pieces ball valve Butt
 Weld full bore ISO mount-
 ing pad with actuator

53291020-015**	5324010	163	124	169	104	1/2"
53291020-020*	5324020	210,5	169	181	110	3/4"
53291020-025*	5324020	216	169	181	110	1"
53291020-032*	5324035	221	169	181	110	1 1/4"
53291020-040*	5324035	231	169	181	110	1 1/2"
53291020-050*	5324055	267	196	181	110	2"
53291020-065*	5324055	285	196	181	110	2 1/2"
53291020-080*	5324085	-	-	-	-	3"
53291020-100*	5324140	-	-	-	-	4"

- *12V VAC/VDC **24V VAC/VDC

91020
53091020
 ACTUADOR
 ELÉCTRICO
 ALTO VOLTAJE
 ELECTRIC
 ACTUATOR
 HIGH VOLTAGE



Válvula esfera tres piezas
 Butt Weld paso total con
 pletina ISO y actuador
 Three pieces ball valve Butt
 Weld full bore ISO mount-
 ing pad with actuator

53091020-015**	5300010	163	124	169	104	1/2"
53091020-020*	5300020	210,5	169	181	110	3/4"
53091020-025*	5300020	216	169	181	110	1"
53091020-032*	5300035	221	169	181	110	1 1/4"
53091020-040*	5300035	231	169	181	110	1 1/2"
53091020-050*	5300055	267	196	181	110	2"
53091020-065*	5300055	285	196	181	110	2 1/2"
53091020-080*	5300085	-	-	-	-	3"
53091020-100*	5300140	-	-	-	-	4"

- *24V-240V VAC/VDC ** 85V VAC/VDC

Para temperaturas superiores a 70°C se debe montar un puente separador entre la válvula y el actuador.
 At temperatures above 70°C separating bridge must be mounted between the valve and the actuator.

CÓDIGO CODE _____
 ACTUADOR ACTUATOR _____
H ALTURA DESDE EJE DE VÁLVULA A PARTE SUPERIOR DEL ACTUADOR
 HIGH FROM VALVE AXIS TO ACTUATOR TOP _____
F ALTURA DEL ACTUADOR ACTUATOR HIGH _____
A LONGITUD DEL ACTUADOR ACTUATOR LONGITUDE _____
G GROSOR DEL ACTUADOR ACTUATOR THICKNESS _____
 MEDIDA SIZE _____

0912
5100912
 SIMPLE EFECTO
 SIMPLE RETURN
 ACTUATOR



Válvula tres piezas roscar paso total con pletina ISO y actuador
 Three pieces ball valve threaded full bore ISO mounting pad with actuator



5100912-008	5100052	131	92	145	71	1/4"
5100912-010	5100052	131	92	145	71	3/8"
5100912-015	5100052	131	92	145	71	1/2"
5100912-020	5100052	133,5	92	145	71	3/4"
5100912-025	5100063	155	108	169	82	1"
5100912-032	5100063	160	108	169	82	1 1/4"
5100912-040	5100075	182	120	201	94	1 1/2"
5100912-050	5100083	199	128	209	101	2"
5100912-065	5100092	229	140	242	108,5	2 1/2"
5100912-080	5100105	251	153	275	122	3"
5100912-100	5100140	-	-	-	-	4"

- Actuadores neumáticos ATEX
Pneumatic actuators ATEX
- Los actuadores neumáticos están calculados en base a una presión de aire de entrada de 6 Bares
Pneumatic actuators are calculated based on an inlet air pressure of 6 Bar

0912
5200912
 DOBLE EFECTO
 DOUBLE ACTING
 ACTUATOR



Válvula tres piezas roscar paso total con pletina ISO y actuador
 Three pieces ball valve threaded full bore ISO mounting pad with actuator



5200912-008	5200052	131	92	145	71	1/4"
5200912-010	5200052	131	92	145	71	3/8"
5200912-015	5200052	131	92	145	71	1/2"
5200912-020	5200052	133,5	92	145	71	3/4"
5200912-025	5200052	139	92	145	71	1"
5200912-032	5200052	144	92	145	71	1 1/4"
5200912-040	5200063	170	108	169	82	1 1/2"
5200912-050	5200063	179	108	169	82	2"
5200912-065	5200083	217	128	209	101	2 1/2"
5200912-080	5200083	226	128	209	101	3"
5200912-100	5200125	-	-	-	-	4"

- Actuadores neumáticos ATEX
Pneumatic actuators ATEX
- Los actuadores neumáticos están calculados en base a una presión de aire de entrada de 6 Bares
Pneumatic actuators are calculated based on an inlet air pressure of 6 Bar

0912
5320912
 ACTUADOR ELÉCTRICO BAJO VOLTAJE
 ELECTRIC ACTUATOR LOW VOLTAGE



Válvula tres piezas roscar paso total con pletina ISO y actuador
 Three pieces ball valve threaded full bore ISO mounting pad with actuator

5320912-008**	5324010	163	124	169	104	1/4"
5320912-010**	5324010	163	124	169	104	3/8"
5320912-015**	5324010	163	124	169	104	1/2"
5320912-020*	5324020	210,5	169	181	110	3/4"
5320912-025*	5324020	216	169	181	110	1"
5320912-032*	5324035	221	169	181	110	1 1/4"
5320912-040*	5324035	231	169	181	110	1 1/2"
5320912-050*	5324055	267	196	181	110	2"
5320912-065*	5324055	285	196	181	110	2 1/2"
5320912-080*	5324085	294	196	181	128	3"
5320912-100*	5324140	-	-	-	-	4"

- *12V VAC/VDC **24V VAC/VDC

0912
5300912
 ACTUADOR ELÉCTRICO ALTO VOLTAJE
 ELECTRIC ACTUATOR HIGH VOLTAGE



Válvula tres piezas roscar paso total con pletina ISO y actuador
 Three pieces ball valve threaded full bore ISO mounting pad with actuator

5300912-008**	5300010	163	124	169	104	1/4"
5300912-010**	5300010	163	124	169	104	3/8"
5300912-015**	5300010	163	124	169	104	1/2"
5300912-020*	5300020	210,5	169	181	110	3/4"
5300912-025*	5300020	216	169	181	110	1"
5300912-032*	5300035	221	169	181	110	1 1/4"
5300912-040*	5300035	231	169	181	110	1 1/2"
5300912-050*	5300055	267	196	181	110	2"
5300912-065*	5300055	285	196	181	110	2 1/2"
5300912-080*	5300085	294	196	181	128	3"
5300912-100*	5300140	-	-	-	-	4"

- *24V-240V VAC/VDC ** 85V VAC/VDC

Para temperaturas superiores a 70°C se debe montar un puente separador entre la válvula y el actuador.
 At temperatures above 70°C separating bridge must be mounted between the valve and the actuator.

CÓDIGO CODE
 ACTUADOR ACTUATOR
H ALTURA DESDE EJE DE VÁLVULA A PARTE SUPERIOR DEL ACTUADOR
 HIGH FROM VALVE AXIS TO ACTUATOR TOP
F ALTURA DEL ACTUADOR ACTUATOR HIGH
A LONGITUD DEL ACTUADOR ACTUATOR LENGTH
G GROSOR DEL ACTUADOR ACTUATOR THICKNESS
 MEDIDA SIZE

91031
51091031
 SIMPLE EFECTO
 SIMPLE RETURN
 ACTUATOR



Válvula esfera tipo wafer
 paso total con pletina ISO
 con actuador
 Ball valve wafer-type with
 ISO mounting pad and
 actuator



51091031-015	5100052	139	92	145	71	1/2"
51091031-020	5100052	146	92	145	71	3/4"
51091031-025	5100075	180	120	201	94	1"
51091031-032	5100075	192	120	201	94	1 1/4"
51091031-040	5100083	206	128	209	101	1 1/2"
51091031-050	5100092	225	140	242	108,5	2"
51091031-065	5100105	258	153	275	122	2 1/2"
51091031-080	5100125	290	175	332	137,5	3"
51091031-100	5100140	313,5	191,5	385	153	4"

- Actuadores neumáticos ATEX
Pneumatic actuators ATEX
- Los actuadores neumáticos están calculados en base a una presión de aire de entrada de 6 Bares
Pneumatic actuators are calculated based on an inlet air pressure of 6 Bar

91031
52091031
 DOBLE EFECTO
 DOUBLE ACTING
 ACTUATOR



Válvula esfera tipo wafer
 paso total con pletina ISO
 con actuador
 Ball valve wafer-type with
 ISO mounting pad and
 actuator



52091031-015	5200052	139	92	145	71	1/2"
52091031-020	5200052	146	92	145	71	3/4"
52091031-025	5200052	152	92	145	71	1"
52091031-032	5200052	164	92	145	71	1 1/4"
52091031-040	5200063	186	108	169	82	1 1/2"
52091031-050	5200063	193	108	169	82	2"
52091031-065	5200075	225	120	201	94	2 1/2"
52091031-080	5200083	243	128	209	101	3"
52091031-100	5200105	275	153	275	122	4"

- Actuadores neumáticos ATEX
Pneumatic actuators ATEX
- Los actuadores neumáticos están calculados en base a una presión de aire de entrada de 6 Bares
Pneumatic actuators are calculated based on an inlet air pressure of 6 Bar

91031
53291031
 ACTUADOR
 ELÉCTRICO
 BAJO VOLTAJE
 ELECTRIC
 ACTUATOR
 LOW VOLTAGE



Válvula esfera tipo wafer
 paso total con pletina ISO
 con actuador
 Ball valve wafer-type with
 ISO mounting pad and
 actuator

53291031-015	5324020	216	169	181	110	1/2"
53291031-020	5324020	223	169	181	110	3/4"
53291031-025	5324020	229	169	181	110	1"
53291031-032	5324020	241	169	181	110	1 1/4"
53291031-040	5324035	247	169	181	110	1 1/2"
53291031-050	5324035	254	169	181	110	2"
53291031-065	5324055	301	196	181	110	2 1/2"
53291031-080	5324085	311	196	181	128	3"
53291031-100	5324140	376	254	235	214	4"

- 12V VAC/VDC

91031
53091031
 ACTUADOR
 ELÉCTRICO
 ALTO VOLTAJE
 ELECTRIC
 ACTUATOR
 HIGH VOLTAGE



Válvula esfera tipo wafer
 paso total con pletina ISO
 con actuador
 Ball valve wafer-type with
 ISO mounting pad and
 actuator

53091031-015	5300020	216	169	181	110	1/2"
53091031-020	5300020	223	169	181	110	3/4"
53091031-025	5300020	229	169	181	110	1"
53091031-032	5300020	241	169	181	110	1 1/4"
53091031-040	5300035	247	169	181	110	1 1/2"
53091031-050	5300035	254	169	181	110	2"
53091031-065	5300055	301	196	181	110	2 1/2"
53091031-080	5300085	311	196	181	128	3"
53091031-100	5300140	376	254	235	214	4"

- 24V-240V VAC/VDC

Para temperaturas superiores a 70°C se debe montar un puente separador entre la válvula y el actuador.
 At temperatures above 70°C separating bridge must be mounted between the valve and the actuator.

CÓDIGO CODE
 ACTUADOR ACTUATOR
H ALTURA DESDE EJE DE VÁLVULA A PARTE SUPERIOR DEL ACTUADOR
 HIGH FROM VALVE AXIS TO ACTUATOR TOP
F ALTURA DEL ACTUADOR ACTUATOR HIGH
A LONGITUD DEL ACTUADOR ACTUATOR LENGTH
G GROSOR DEL ACTUADOR ACTUATOR THICKNESS
 MEDIDA SIZE

91032
51091032
 SIMPLE EFECTO
 SIMPLE RETURN
 ACTUATOR



Válvula esfera tipo wafer con pletina ISO, camisa y actuador
 Ball valve wafer-type with ISO mounting pad, heating chamber and actuator



51091032-015	5100052	139	92	145	71	1/2"
51091032-020	5100052	146	92	145	71	3/4"
51091032-025	5100075	180	120	201	94	1"
51091032-032	5100075	192	120	201	94	1 1/4"
51091032-040	5100083	206	128	209	101	1 1/2"
51091032-050	5100092	225	140	242	108,5	2"
51091032-065	5100105	258	153	275	122	2 1/2"
51091032-080	5100125	290	175	332	137,5	3"
51091032-100	5100140	313,5	191,5	385	153	4"

- Actuadores neumáticos ATEX
Pneumatic actuators ATEX
- Los actuadores neumáticos están calculados en base a una presión de aire de entrada de 6 Bares
Pneumatic actuators are calculated based on an inlet air pressure of 6 Bar

91032
52091032
 DOBLE EFECTO
 DOUBLE ACTING
 ACTUATOR



Válvula esfera tipo wafer con pletina ISO, camisa y actuador
 Ball valve wafer-type with ISO mounting pad, heating chamber and actuator



52091032-015	5200052	139	92	145	71	1/2"
52091032-020	5200052	146	92	145	71	3/4"
52091032-025	5200052	152	92	145	71	1"
52091032-032	5200052	164	92	145	71	1 1/4"
52091032-040	5200063	186	108	169	82	1 1/2"
52091032-050	5200063	193	108	169	82	2"
52091032-065	5200075	225	120	201	94	2 1/2"
52091032-080	5200083	243	128	209	101	3"
52091032-100	5200105	275	153	275	122	4"

- Actuadores neumáticos ATEX
Pneumatic actuators ATEX
- Los actuadores neumáticos están calculados en base a una presión de aire de entrada de 6 Bares
Pneumatic actuators are calculated based on an inlet air pressure of 6 Bar

91032
53291032
 ACTUADOR ELÉCTRICO BAJO VOLTAJE
 ELECTRIC ACTUATOR LOW VOLTAGE



Válvula esfera tipo wafer con pletina ISO, camisa y actuador
 Ball valve wafer-type with ISO mounting pad, heating chamber and actuator

53291032-015	5324020	216	169	181	110	1/2"
53291032-020	5324020	223	169	181	110	3/4"
53291032-025	5324020	229	169	181	110	1"
53291032-032	5324020	241	169	181	110	1 1/4"
53291032-040	5324035	247	169	181	110	1 1/2"
53291032-050	5324035	254	169	181	110	2"
53291032-065	5324055	301	196	181	110	2 1/2"
53291032-080	5324085	311	196	181	128	3"
53291032-100	5324140	376	254	235	214	4"

- 12V VAC/VDC

91032
53091032
 ACTUADOR ELÉCTRICO ALTO VOLTAJE
 ELECTRIC ACTUATOR HIGH VOLTAGE



Válvula esfera tipo wafer con pletina ISO, camisa y actuador
 Ball valve wafer-type with ISO mounting pad, heating chamber and actuator

53091032-015	5300020	216	169	181	110	1/2"
53091032-020	5300020	223	169	181	110	3/4"
53091032-025	5300020	229	169	181	110	1"
53091032-032	5300020	241	169	181	110	1 1/4"
53091032-040	5300035	247	169	181	110	1 1/2"
53091032-050	5300035	254	169	181	110	2"
53091032-065	5300055	301	196	181	110	2 1/2"
53091032-080	5300085	311	196	181	128	3"
53091032-100	5300140	376	254	235	214	4"

- 24V-240V VAC/VDC

Para temperaturas superiores a 70°C se debe montar un puente separador entre la válvula y el actuador.
 At temperatures above 70°C separating bridge must be mounted between the valve and the actuator.

4

CONEXIONES FLEXIBLES

FLEXIBLE CONNECTIONS



INOX
STAINLESS
STEEL

10 BAR

70°C

DN8

150 mm.
1000 mm.

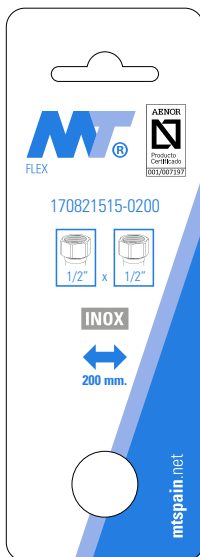

Conexiones:
HEMBRA - HEMBRA
MACHO - HEMBRA

Connections:
FEMALE - FEMALE
MALE - FEMALE



 **FICHA TÉCNICA**
TECHNICAL SHEET

El producto incorpora hantag para línea de venta con información técnica y comercial.

The item is individually labeled with a hangtag indicating specific technical information.

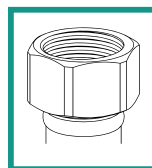
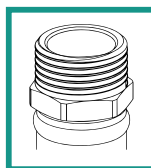

CÓDIGO CODE	_____
MEDIDA SIZE	_____
LONGITUD LENGHT	_____
ENCAJADO GRANDE MASTER CARTON	_____
ENCAJADO INTERMEDIO INNER CARTON	_____

170821010



Conexión flexible
"latiguillo" DN8 H-H acero
inoxidable **3/8" x 3/8"**

F-F flexible DN8 stainless
steel connection
3/8" x 3/8"

AENOR
EAN CODE

170821010-0150	3/8" x 3/8"	150 mm.	150	10
170821010-0200	3/8" x 3/8"	200 mm.	100	10
170821010-0250	3/8" x 3/8"	250 mm.	80	10
170821010-0300	3/8" x 3/8"	300 mm.	100	10
170821010-0350	3/8" x 3/8"	350 mm.	100	10
170821010-0400	3/8" x 3/8"	400 mm.	120	10
170821010-0450	3/8" x 3/8"	450 mm.	100	10
170821010-0500	3/8" x 3/8"	500 mm.	100	10
170821010-0600	3/8" x 3/8"	600 mm.	100	10
170821010-0800	3/8" x 3/8"	800 mm.	100	10
170821010-1000	3/8" x 3/8"	1000 mm.	50	10

170821015



Conexión flexible
"latiguillo" DN8 H-H acero
inoxidable **3/8" x 1/2"**

F-F flexible DN8 stainless
steel connection
3/8" x 1/2"

AENOR
EAN CODE

170821015-0150	3/8" x 1/2"	150 mm.	150	10
170821015-0200	3/8" x 1/2"	200 mm.	100	10
170821015-0250	3/8" x 1/2"	250 mm.	80	10
170821015-0300	3/8" x 1/2"	300 mm.	100	10
170821015-0350	3/8" x 1/2"	350 mm.	100	10
170821015-0400	3/8" x 1/2"	400 mm.	120	10
170821015-0500	3/8" x 1/2"	500 mm.	100	10
170821015-0600	3/8" x 1/2"	600 mm.	100	10
170821015-0800	3/8" x 1/2"	800 mm.	100	10
170821015-1000	3/8" x 1/2"	1000 mm.	50	10

170821515



Conexión flexible
"latiguillo" DN8 H-H acero
inoxidable **1/2" x 1/2"**

F-F flexible DN8 stainless
steel connection
1/2" x 1/2"

AENOR
EAN CODE

170821515-0150	1/2" x 1/2"	150 mm.	150	10
170821515-0200	1/2" x 1/2"	200 mm.	80	10
170821515-0250	1/2" x 1/2"	250 mm.	80	10
170821515-0300	1/2" x 1/2"	300 mm.	100	10
170821515-0350	1/2" x 1/2"	350 mm.	80	10
170821515-0400	1/2" x 1/2"	400 mm.	120	10
170821515-0450	1/2" x 1/2"	450 mm.	100	10
170821515-0500	1/2" x 1/2"	500 mm.	100	10
170821515-0600	1/2" x 1/2"	600 mm.	100	10
170821515-0800	1/2" x 1/2"	800 mm.	100	10
170821515-1000	1/2" x 1/2"	1000 mm.	50	10

170811010



Conexión flexible
"latiguillo" DN8 M-H acero
inoxidable **3/8" x 3/8"**

M-F flexible DN8 stainless
steel connection
3/8" x 3/8"

AENOR
EAN CODE

170811010-0150	3/8" x 3/8"	150 mm.	150	10
170811010-0200	3/8" x 3/8"	200 mm.	100	10
170811010-0250	3/8" x 3/8"	250 mm.	80	10
170811010-0300	3/8" x 3/8"	300 mm.	100	10
170811010-0350	3/8" x 3/8"	350 mm.	100	10
170811010-0400	3/8" x 3/8"	400 mm.	120	10
170811010-0500	3/8" x 3/8"	500 mm.	100	10
170811010-0600	3/8" x 3/8"	600 mm.	100	10
170811010-0800	3/8" x 3/8"	800 mm.	100	10
170811010-1000	3/8" x 3/8"	1000 mm.	50	10

170811015



Conexión flexible
"latiguillo" DN8 M-H acero
inoxidable **3/8" x 1/2"**

M-F flexible DN8 stainless
steel connection
3/8" x 1/2"

AENOR
EAN CODE

170811015-0150	3/8" x 1/2"	150 mm.	150	10
170811015-0200	3/8" x 1/2"	200 mm.	100	10
170811015-0250	3/8" x 1/2"	250 mm.	80	10
170811015-0300	3/8" x 1/2"	300 mm.	100	10
170811015-0350	3/8" x 1/2"	350 mm.	100	10
170811015-0400	3/8" x 1/2"	400 mm.	120	10
170811015-0500	3/8" x 1/2"	500 mm.	100	10
170811015-0600	3/8" x 1/2"	600 mm.	100	10
170811015-0800	3/8" x 1/2"	800 mm.	100	10
170811015-1000	3/8" x 1/2"	1000 mm.	50	10

• Rosca macho 3/8" y rosca hembra 1/2"
Male threaded 3/8" and female threaded 1/2"

CÓDIGO CODE	_____
MEDIDA SIZE	_____
LONGITUD LENGHT	_____
ENCAJADO GRANDE MASTER CARTON	_____
ENCAJADO INTERMEDIO INNER CARTON	_____

170811510



Conexión flexible
"latiguillo" DN8 M-H acero
inoxidable **1/2" x 3/8"**

M-F flexible DN8 stainless
steel connection
1/2" x 3/8"

AENOR

EAN CODE

170811510-0150	1/2" x 3/8"	150 mm.	150	10
170811510-0200	1/2" x 3/8"	200 mm.	100	10
170811510-0250	1/2" x 3/8"	250 mm.	80	10
170811510-0300	1/2" x 3/8"	300 mm.	100	10
170811510-0350	1/2" x 3/8"	350 mm.	100	10
170811510-0400	1/2" x 3/8"	400 mm.	120	10
170811510-0450	1/2" x 3/8"	450 mm.	100	10
170811510-0500	1/2" x 3/8"	500 mm.	100	10
170811510-0600	1/2" x 3/8"	600 mm.	100	10
170811510-0800	1/2" x 3/8"	800 mm.	100	10
170811510-1000	1/2" x 3/8"	1000 mm.	50	10

- Rosca macho 1/2" y rosca hembra 3/8"
Male threaded 1/2" and female threaded 3/8"

170811515



Conexión flexible
"latiguillo" DN8 M-H acero
inoxidable **1/2" x 1/2"**

M-F flexible DN8 stainless
steel connection
1/2" x 1/2"

AENOR

EAN CODE

170811515-0150	1/2" x 1/2"	150 mm.	150	10
170811515-0200	1/2" x 1/2"	200 mm.	80	10
170811515-0250	1/2" x 1/2"	250 mm.	80	10
170811515-0300	1/2" x 1/2"	300 mm.	100	10
170811515-0350	1/2" x 1/2"	350 mm.	80	10
170811515-0400	1/2" x 1/2"	400 mm.	120	10
170811515-0450	1/2" x 1/2"	450 mm.	100	10
170811515-0500	1/2" x 1/2"	500 mm.	100	10
170811515-0600	1/2" x 1/2"	600 mm.	100	10
170811515-0800	1/2" x 1/2"	800 mm.	100	10
170811515-1000	1/2" x 1/2"	1000 mm.	50	10

5

INSTRUMENTOS DE MEDICIÓN

MEASUREMENT TOOLS

5

INSTRUMENTOS DE MEDICIÓN

MEASUREMENT TOOLS



Producto 8799

Manómetro acero inoxidable
glicerina DN63 conexión inferior
inoxidable 1/4" (p.202)

Product 8799

Stainless steel glycerine filled
pressure gauge DN63 stainless steel
bottom connection 1/4" (p.202)

CARACTERÍSTICAS

Acorde con EN837-1
Escala de medida positiva
y dual, unidades: BAR/PSI
Manómetro analógico
Rosca 1/2" BSP macho

FEATURES

Following EN837-1
Positive and Dual Scale
units: BAR/PASI
Analog manometers
Thread 1/2" BSP male

LÍMITES TÉCNICOS

Temperatura ambiente: de -20°C a +60°C
Temperatura de proceso: hasta +60°C
Se recomienda que la presión de trabajo sea
inferior al 75% del rango total para presiones
sostenidas y 65% para presiones fluctuantes.

TECHNICAL LIMITS

Ambient Temperature: from -20°C to +60°C
Process Temperature: until +60°C
Recommended maximum working pressure must
be less than 75% of the total range for sustained
pressure and 65% for fluctuating pressures.

CÓDIGO CODE _____
 BAR BAR _____
 DIAL (BAR) DIAL (BAR) _____
 ENCAJADO GRANDE MASTER CARTON _____
 ENCAJADO INTERMEDIO INNER CARTON _____

8400



Manómetro esfera seca
DN50 conexión posterior
latón 1/4"

Dry sphere pressure gauge
DN50 brass back connec-
tion 1/4"

EAN CODE

8400-02	0-2,5	0.1	60	1
8400-04	0-4	0.1	60	1
8400-06	0-6	0.1	60	1
8400-10	0-10	0.2	60	1
8400-16	0-16	0.2	60	1

• Rango de precisión: ± 1,6%
Precision range: ± 1,6%



FICHA TÉCNICA
TECHNICAL SHEET

8500



Manómetro esfera seca
DN50 conexión inferior
latón 1/4"

Dry sphere pressure
gauge DN50 brass bottom
connection 1/4"

EAN CODE

8500-02	0-2,5	0.1	72	1
8500-04	0-4	0.1	72	1
8500-06	0-6	0.1	72	1
8500-10	0-10	0.2	72	1
8500-16	0-16	0.2	72	1

• Rango de precisión: ± 1,6%
Precision range: ± 1,6%



FICHA TÉCNICA
TECHNICAL SHEET

8599



Manómetro acero
inoxidable glicerina DN63
conexión inferior latón 1/4"

Stainless steel glycerine
filled pressure gauge DN63
brass bottom connection
1/4"

EAN CODE

8599-02	0-2,5	0.05	54	1
8599-04	0-4	0.1	54	1
8599-06	0-6	0.1	54	1
8599-10	0-10	0.2	54	1
8599-16	0-16	0.2	54	1
8599-25	0-25	0.5	54	1
8599-40	0-40	1.0	54	1
8599-60	0-60	1.0	54	1
8599-100	0-100	2.0	54	1

• Rango de precisión: ± 1,6%
Precision range: ± 1,6%



FICHA TÉCNICA
TECHNICAL SHEET

8799



Manómetro acero
inoxidable glicerina DN63
conexión inferior inoxida-
ble 1/4"

Stainless steel glycerine
filled pressure gauge DN63
stainless steel bottom
connection 1/4"

EAN CODE INOX

8799-02	0-2,5	0.1	54	1
8799-04	0-4	0.1	54	1
8799-06	0-6	0.1	54	1
8799-10	0-10	0.2	54	1
8799-16	0-16	0.2	54	1
8799-25	0-25	1.0	54	1
8799-40	0-40	2.0	54	1
8799-60	0-60	2.0	54	1
8799-100	0-100	5.0	54	1

• Rango de precisión: ± 1,6%
Precision range: ± 1,6%



FICHA TÉCNICA
TECHNICAL SHEET

CÓDIGO CODE	_____
BAR BAR	_____
DIAL (BAR) DIAL (BAR)	_____
ENCAJADO GRANDE MASTER CARTON	_____
ENCAJADO INTERMEDIO INNER CARTON	_____

8600



Manómetro acero inoxidable glicerina DN100 conexión inferior latón 1/2"

Stainless steel glycerine filled pressure gauge DN100 brass bottom connection 1/2"

EAN CODE **INOX**

8600-06	0-6	0.1	16	1
8600-10	0-10	0.2	16	1
8600-16	0-16	0.2	16	1
8600-40	0-40	1.0	16	1
8600-100	0-100	2.0	16	1

- Rango de precisión: ± 1,6%
Precision range: ± 1,6%
- Caja acero inoxidable
Stainless steel case



FICHA TÉCNICA
TECHNICAL SHEET

8800



Manómetro acero inoxidable glicerina DN100 conexión inferior inoxidable 1/2"

Stainless steel glycerine filled pressure gauge DN100 stainless steel bottom connection 1/2"

EAN CODE **INOX**

8800-06	0-6	0.1	16	1
8800-10	0-10	0.2	16	1
8800-16	0-16	0.2	16	1
8800-40	0-40	1.0	16	1
8800-100	0-100	2.0	16	1

- Rango de precisión: ± 1,6%
Precision range: ± 1,6%
- Caja acero inoxidable
Stainless steel case



FICHA TÉCNICA
TECHNICAL SHEET

6

MAC3

6

MAC3



Mac3, fabricante líder mundial de interruptores de flotador, es una sólida empresa italiana que opera en todo el mundo, ofreciendo productos electrónicos y electromecánicos de alta calidad, desarrollados específicamente para sistemas hidráulicos.

La compañía fue fundada con la intención de ofrecer productos de calidad en el ámbito de la regulación de niveles y se ha convertido en líder mundial en la producción de interruptores de flotador. Hoy en día ofrece productos electrónicos y electromecánicos de alta calidad desarrollados específicamente para sistemas hidráulicos.

Mac3 es sinónimo de alta tecnología y fiabilidad en todo el mundo. Su gama de productos, resultado de una cuidadosa investigación técnica de aplicación, cubren todas las necesidades de control de líquidos.

Homologación ENEC

La marca ENEC es el acrónimo de "European Norms Electrical Certification". Surge del acuerdo de 20 países europeos (ENEC acuerdo aprobado por el Cenelec Mark Committee) y certifica que un producto cumple con las normas europeas EN y está construido por las empresas con sistemas de calidad según la norma ISO 9000. A la marca ENEC se la reconoce como equivalente a las marcas individuales.

Mac3, a world leader in float switches, is a solid Italian company operating throughout the World, offering electronic and electromechanical products of excellent quality developed specifically for the hydraulic field.

The company was founded with the aim of providing quality products in the field of regulation of levels and has become the world leader in the production of float switches. Today it offers electronic and electromechanical products with high quality and developed specifically for the hydraulics.

Mac3 is synonymous around the World of high technology and reliability. The product range, which is the result of extensive technical and applicative research, covers all liquid control.

ENEC approval

The ENEC mark stands for "European Norms Electrical certification". It is the fruit of agreements with 20 European bodies (ENEC agreement approved by the Cenelec Mark Committee) which certifies that the product complies with the EN European norms and has been produced by companies certified in accordance with ISO 9000 quality standards. The ENEC mark is recognized as being equivalent to individual national marks.



CÓDIGO CODE _____
 MEDIDA SIZE _____

KEY



Regulador de nivel electro-mecánico

Tiene una elevada fiabilidad, es el más usado del mundo para la automatización de electrobombas y en tanques de almacenamiento. Su tamaño lo hace más versátil para cada aplicación. Para aguas limpias.

Electromechanical float switches

High reliability, is the most universally used float switch in the world for the automation of pumps and storage tanks. Its size makes it the most versatile for any application. For clean water.

KPM0206KYOC	2 m Cable PVC 3x1 μ16 (4)
KPM0306KYOC	3 m Cable PVC 3x1 μ16 (4)
KPM0506KYOC	5 m Cable PVC 3x1 μ16 (4)

- Contrapeso incluido
Counterweight included

MAC3



Regulador de nivel electro-mecánico

Es el producto histórico, tiene un buen tamaño y una forma libre de rugosidad que lo hace adecuado para instalaciones con aguas residuales. Dispositivo fabricado con doble cámara estanca para máxima seguridad, es el producto más fiable del mercado.

Electromechanical float switches

The historical device, thanks to its large size and its shape without edges, for which it is particularly suitable for sewage water, this device is made with a double liquid proof chamber which assures the maximum reliability of the inside.

MPM0206GB0C	2 m Cable PVC 3x1 μ16 (4)
MPM0306GB0C	3 m Cable PVC 3x1 μ16 (4)
MPM0506GB0C	5 m Cable PVC 3x1 μ16 (4)
MPM1006GB0C	10 m Cable PVC 3x1 μ16 (4)

- Contrapeso incluido
Counterweight included

AGMA



Regulador nivel aguas residuales

Dispositivo muy compacto normalmente instalado en bombas de drenaje. Tal dispositivo se puede incluso usar cuando hay sedimentos en el agua. Cuando no se puedan usar flotadores tradicionales; el dispositivo se puede usar en aguas residuales, previa verificación y limpieza periódica de los mecanismos de flotación. Para aguas limpias y residuales.

Small wells regulator

Compact device usually installed on drainage pumps. This device is useful even in the presence of debris in the water. If it is not possible to use a floating tilting, it can also be used in the presence of waste water in compliance with periodical verification and cleaning of the mechanisms of buoyancy. Clean and sewage water.

AGWPC50000	50 m. Cable PVC 3x1 μ20(8)
AGWPM03000	3 m. Cable PVC 3x1 μ20(8)
AGWPM05000	5 m. Cable PVC 3x1 μ20(8)

MAC5



Regulador nivel aguas residuales

ATEX

Regulador de nivel por inclinación para aguas residuales del alcantarillado. Tiene un cuerpo pesado, voluminoso y carente de asperezas que lo hace ideal para su uso en aguas residuales de alcantarillado, industriales con residuos de aglomerados en suspensión y aguas turbulentas. Fabricado con una doble cámara estanca. Disponibles en diversos tipos de cable ideales para distintas instalaciones.

Electromechanical float switches for sewage water

Tilting level regulator for sewage water. It's principal feature being its heavy body, which is also bulky and free of any irregularity, making it ideal for use in sewage water, in industrial waste with suspended agglomerate residues and in tumultuous water. It is made with a double airtight chamber. Available with differents types of cable. industrial waste with suspended agglomerate residues and in tumultuous water. It is made with a double airtight chamber. Available with differents types of cable.

JPM0506BGO	5 m. Cable PVC 3x1 μ20(8)
JPM1006BGO	10 m. Cable PVC 3x1 μ20(8)
JPM2006BGO	20 m. Cable PVC 3x1 μ20(8)
JPM0506BGO ATEX*	5 m. Cable
JPM1006BGO ATEX*	10 m. Cable

- * ATEX color negro
* ATEX black color

- Aguas sucias
Sewage

CÓDIGO CODE _____
MEDIDA SIZE _____

E-FLY

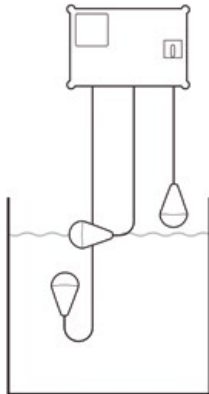

Regulador nivel aguas residuales

ATEX

Aplicación: su cuerpo es más pequeño en tamaño, en comparación con Mac 5 y libre de protuberancias, adecuado para su uso en tanques pequeños para la eliminación de aguas residuales.
Ventajas: hecho con una cámara sellada doble y contrapeso incorporado en el cuerpo del flotador. También disponible versión ATEX Certified.

Electromechanical float switches for sewage water

Application: it has a body of a smaller size, compared to Mac 5, without harshness, suitable for use in small tanks for disposal of sewage water.
Advantages: made with a double liquid proof chamber and counterweight built into the body of the float. Also available ATEX version approved.

EPM0506B00	5 m. Cable PVC 3x1 μ20(8)
EPM1006BGO	10 m. Cable PVC 3x1 μ20(8)
EPM2006BGO	20 m. Cable PVC 3x1 μ20(8)
EPM5060 ATEX*	5 m. Cable
EPM10060 ATEX*	10 m. Cable

- * ATEX color negro
- * ATEX black color
- Aguas sucias Sewage

QUICK STOP



Regulador hidráulico de cierre inmediato

QuickStop es un regulador hidráulico de nivel patentado que elimina los típicos defectos de estos aparatos (flotadores mecánicos). Su característica principal es la rapidez para actuar en el sistema que pasa de abierto a cerrado y viceversa en una fracción de segundo, evitando el goteo en el llenado por restricción y disminuyendo sensiblemente el tiempo de llenado.
Amplia gama desde 3/8" hasta 1 1/2". El mecanismo de regulación es muy simple y versátil y actúa sobre el ángulo de unión, así como la longitud e inclinación del brazo.

Instant closure hydraulic regulator

QuickStop is a hydraulic level regulator of advanced design that eliminates the classic defects of such devices (mechanical floats). Its main feature is the velocity of operation of the system which goes from open to closed and viceversa in a fraction of a second, avoiding long noise periods and the dripping due to choked filling. It's available in a wide range of models, from 3/8" to 1 1/2". The mechanism of regulation is very simple, it operates on then angle of the joint and the length and angle of the arm.

QS0000BR09 *	3/8"
QS0000BR12 *	1/2"
QS0000BR18 **	3/4"
QS0000BR25**	1"
QS0000BR32**	1 1/4"
QS0000BR40**	1 1/2"

- * Color Blanco / ** Color negro
- * White color / ** Black color
- Presión máxima 6 BAR
Maximum pressure 6 BAR

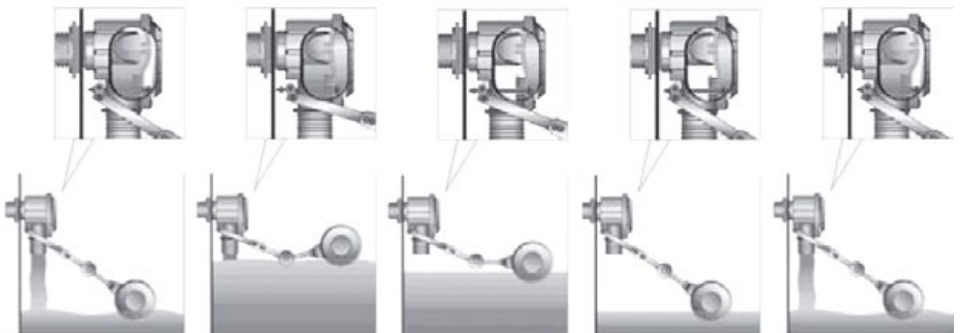

CÓDIGO CODE _____
 MEDIDA SIZE _____

SUPER SIMPLEX E



Regulador de presurización electrónico para bombas
 SuperSimplex E es un presostato muy versátil que le permite ajustar la presión de arranque entre 0,8 a 2 bares a través de un mando frontal y un manómetro de presión en el dispositivo. Desde fábrica se suministra ajustado a 1,5 bar. SuperSimplex E, versión electrónica con la protección de funcionamiento en seco y reinicio automático.

Electronic control system of one pump for pressurization of the water
 The SuperSimplex E electronic pump regulator is a very versatile device that allows to adjust the restart pressure from 0,8 to 2 bar and through an external front handle and pressure gauge. It comes preset to 1,5 bar. SuperSimplex E, an electronic version, with dry running protection and automatic restart.

VSPXE00G00 MOD.E1.5-8 bar

- Potencia máxima de la bomba 2HP monofásica
 Maximum power pump 2HP single phase

• **Recambio** disponibles en página 224
Spare part available page 224

MC SWITCH

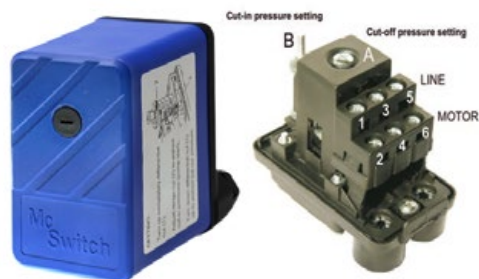

Presostato para sistemas de presurización
 El Mc Switch es la gama de presostato de MAC3. El dispositivo viene calibrado de fábrica con una presión de ajuste que se puede cambiar a través del sistema de control interno. La instalación del MacPress se realiza directamente en el tubería mediante una conexión hembra de 1/4". Está disponible para bombas tanto monofásicas como trifásicas en las dos versiones de alta y baja presión.

Pressure switch for pressurization systems
 Mc Switch is a pressure switches of MAC3. The device comes with a factory set pressure setting that can be changed using the internal regulating system. Macpress is installed directly on the pipe through a coupling by 1/4". The device is available for both single and three phase pumps in two versions for high and low pressure.

VPMB2035S001 M rango/range 2-3, 5 bar
 Monofásico/single phase

CÓDIGO CODE _____
 MEDIDA SIZE _____

E POWER

Variador de velocidad

Variable frequency drive



VEPR1130000	Para bomba monofásica For single phase pump 230V 50-60Hz (e-MM08)
VEPR2120000	Para bomba trifásica Three phase 230V 50-60Hz (e-Mt10)

- Potencia máxima de la bomba monofásica 1,5HP
Maximum power of 1.5 HP for single phase pump
- Potencia máxima de la bomba trifásica 3HP
Maximum power of 3 HP for three phase pumpV

E POWER

Los inverters de Mac3 son controladores variadores de frecuencia (VFD), especialmente desarrollados para actuar sobre de bombas monofásicas y trifásicas.

En un sistema hidráulico la demanda de caudal máximo es ocasional y, de hecho, existen a menudo extracciones de agua no simultáneas, por lo que la demanda de caudal es variable, de modo que la bomba generalmente necesita trabajar con una velocidad variable en lugar de una velocidad fija (como en los sistemas tradicionales) de manera que el dispositivo trabajará a velocidad moderada con un bajo consumo de energía.

En los sistemas dinámicos de fluidos la relación entre potencia absorbida y la velocidad es de tipo cúbico, de modo que con un menor consumo de ciclos (Hz) se traduce en un alto ahorro energético.

Además del ahorro en el consumo de energía que genera el VDF, el VDF es importante para los fabricantes de sistemas de presión, ya que se traduce en economía de costes, además de otras ventajas importantes en términos de confort, rendimiento y durabilidad, que superan a los equipos tradicionales con vasos de presión. La instalación se realiza directamente en la tubería, ya que se refrigera por agua y el dispositivo tiene un sensor de presión integrado.

El dispositivo presenta una entrada ON/OFF para encender o apagar la bomba por medio de un flotador de mínima o interruptor y un relé de salida de contacto seco que puede ser usado como una señal de alarma o para impulsar un sistema para ensamblar grupos con una segunda bomba a velocidad fija.

Mac3 inverters are VFD variable frequency drivers, specially projected for driving pumps.

In a water supply system, the demand of maximum delivery is occasional, and in fact there is often the need for variable delivery rates, so that the pump usually needs to operate at a variable delivery rate, rather than at a fixed rate (as in the case of traditional systems) so that the same will work at rates for most of the time with low energy consumption.

In fluid dynamic systems the ratio between the absorbed power and speed is of cubic type; so that only a few less Hz translates into a much lower Kw consumption.

VFD's boosting systems, in addition to energy savings, for the customer translates into a cost economics, bring other important advantages in terms of confort, performance and durability of the system. The installation is directly on the pipe, cooled by water and the device has a built-in-pressure sensor.

The device has an ON/OFF input for a float switch and an output contact relay that can be used as a warning signal or to built boosting system with a second pump at a fixed rate.

CÓDIGO CODE _____
 MEDIDA SIZE _____

ELECTRO SONDA Q



Electrosonda Q

De sensibilidad alta, baja y variable para la barra DIN. Las electrosondas producidas por Mac3 de la serie Q son reguladores para líquidos conductores, aptas para controlar el nivel mínimo y máximo en pozos profundos, tanques, cisternas, etc.

Su funcionamiento se basa en la detección del líquido por parte de la unidad de control de la resistencia del líquido, cuyo nivel se controla por medio de sondas apropiadamente colocadas en el mismo, de las cuales la más larga actúa como común. Cuando el nivel del líquido dentro del recipiente o del pozo moja las tres sondas sumergidas se activa inmediatamente el relé, y se desactiva tan sólo en el momento en que desciende el nivel, dejando al descubierto la sonda baja.

Q electroprobe

At high, low and variable sensitivity for DIN rail. The electroprobes of the Q series produced by Mac3 are regulators of conductive fluid suitable for the minimum and maximum level control of deep well, tanks, cisterns etc.

The operating principle is based on the detection of the fluid resistance on the part of the control box, the level being controlled by means of special probes immersed in the liquid with the longest acting as a common element. When the level of the liquid inside the container or the well wets all three probes a relay is activated and subsequently deactivated only when the level descends, uncovering the lower probe.

EQ3SC01000	Normal 5,6k (230v)
EQ3SC01003	Normal 5.6k (230v) + 3 sondas

CÓDIGO CODE _____
 MEDIDA SIZE _____

SONDA



Sonda para electrosonda

Mat. ABS + AISI 316
 Temperatura máxima 80°C,
 accesorio para líquidos conductivos.

Probe for electroprobe

Mat. ABS + AISI 316. Maximum temperature 80°C, accessory for conductive liquids.

TSOND00000	Sonda para electrosonda Probe for electroprobe
------------	---

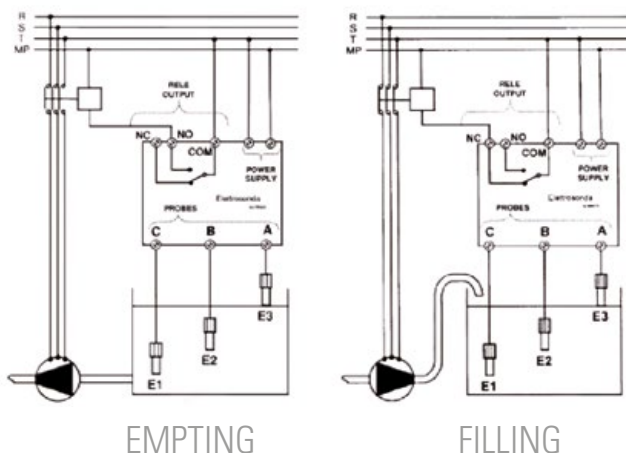

SISTEMAS DE PRESURIZACIÓN BOOSTING SYSTEMS



AGUAS SUCIAS SEWAGE

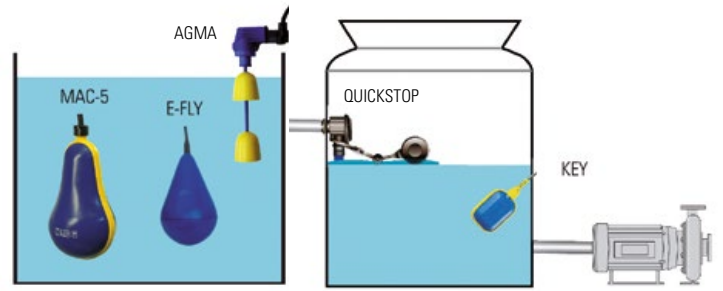

POZOS Y ALJIBES WELLS AND CISTERNS

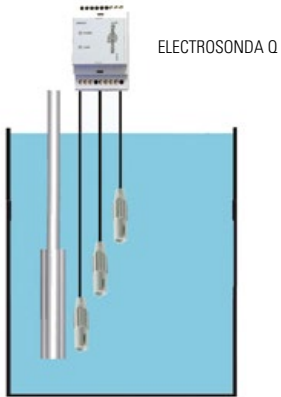

PANEL DE CONTROL CONTROL PANEL



7

ACCESORIOS SANITARIOS

SANITARY FITTINGS

7 ACCESORIOS SANITARIOS

SANITARY FITTINGS

**7.1 VÁLVULAS DE
DESCARGA Y LLENADO** 210
7.1 FLUSH AND FILL VALVES

7.2 FLEXOS DE DUCHA 212
7.2 SHOWER HOSE

**7.3 VÁLVULAS DE FLOTADOR
Y BOYAS** 213
7.3 FLOAT VALVES AND BUOYS

7.4 VÁLVULAS CLICK CLACK 214
7.4 CLICK CLACK VALVES



Rápida instalación
Quick installation



Universal
Universal



Montaje manual
Hand assembly



Boya regulable
Buoy regulation

Conexión adaptable a tanques con
entrada lateral e inferior
Connection adaptable to tanks with
side and bottom entry

Producto 55007
Válvula de llenado
alimentación mixta
(p.211)

Product 55007
Mixed fill valve (p.211)



VÁLVULAS DE DESCARGA Y LLENADO FLUSH AND FILL VALVES

CÓDIGO CODE _____
 MEDIDA SIZE _____
 ENCAJADO GRANDE MASTER CARTON _____
 ENCAJADO INTERMEDIO INNER CARTON _____

55001		Válvula de descarga de doble pulsador con cable EAN CODE	Cable dual flush valve	55001	2"	25	1	<ul style="list-style-type: none"> Tornillos de fijación incluidos Tank fastening screws included
55002		Válvula de llenado alimentación inferior EAN CODE	Bottom fill valve	55002	3/8"	25	1	
55003		Válvula de llenado alimentación lateral EAN CODE	Side fill valve	55003	3/8"	24	1	
55004		Válvula de descarga de pulsador simple EAN CODE	Single flush valve	55004	2"	25	1	

CÓDIGO / CODE _____
MEDIDA / SIZE _____
ENCAJADO GRANDE / MASTER CARTON _____
ENCAJADO INTERMEDIO / INNER CARTON _____

55005



Válvula de descarga de doble pulsador con cable adaptador universal

EAN CODE

Cable dual flush valve universal adaptor

55005 2" 20 1

- Tornillos de fijación incluidos
Tank fastening screws included

55006



Válvula de descarga de doble pulsador

EAN CODE

Dual flush valve

55006 2" 25 1

- Tornillos de fijación incluidos
Tank fastening screws included
- Compatible con las principales marcas de sanitarios
Suitable for the main sanitary brands

55007



Válvula de llenado alimentación mixta

EAN CODE

Mixed fill valve

55007 3/8" 24 1

- Compatible con las principales marcas de sanitarios
Suitable for the main sanitary brands

- **Recambio** junta y tornillos disponible en página 224
Spare part flat gasket and bolts available page 224

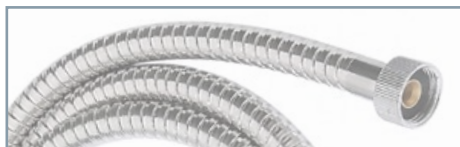



FLEXOS DE DUCHA SHOWER HOSE



FICHA TÉCNICA
TECHNICAL SHEET



CÓDIGO CODE _____
 MEDIDA SIZE _____
 ENCAJADO GRANDE MASTER CARTON _____
 ENCAJADO INTERMEDIO INNER CARTON _____

600		<p>Flexo de ducha en acero inoxidable doble engatillado</p> <p>Shower stainless steel hose double clip</p> <p>EAN CODE</p>	600-02	1/2"	50	1
			<ul style="list-style-type: none"> Longitud 170-210mm. Length 170-210mm. 			
6002		<p>Flexo de ducha en acero inoxidable doble engatillado conectores plástico</p> <p>Shower stainless steel hose double clip plastic connectors</p> <p>EAN CODE</p>	6002-02	1/2"	50	1
			<ul style="list-style-type: none"> Longitud 170-210mm. Length 170-210mm. 			
601		<p>Flexo de ducha flexible pvc</p> <p>Flexible pvc shower hose</p> <p>EAN CODE</p>	601-02	1/2"	40	1
			<ul style="list-style-type: none"> Longitud 175mm. Length 175mm. 			



VÁLVULAS DE FLOTADOR Y BOYAS FLOAT VALVES AND BUOYS

CÓDIGO CODE	_____	_____	_____	_____
MEDIDA SIZE	_____	_____	_____	_____
ENCAJADO GRANDE MASTER CARTON	_____	_____	_____	_____
ENCAJADO INTERMEDIO INNER CARTON	_____	_____	_____	_____

228410



Válvula de flotador
con varilla plana

Float valve with
flat bar

EAN CODE

228410-015	1/2"	-	-
228410-020	3/4"	-	-
228410-025	1"	-	-
228410-032	1 1/4"	-	-
228410-040	1 1/2"	-	-
228410-050	2"	-	-

- Próximo lanzamiento
Release soon

CÓDIGO CODE	_____	_____	_____	_____
MEDIDA SIZE	_____	_____	_____	_____
ROSCA VARILLA ROD THREAD	_____	_____	_____	_____
ENCAJADO GRANDE MASTER CARTON	_____	_____	_____	_____
ENCAJADO INTERMEDIO INNER CARTON	_____	_____	_____	_____

228420



Válvula de flotador
con varilla roscada

Float valve with
threaded rod

EAN CODE

228420-015	1/2"	6/100	-	-
228420-020	3/4"	7/100	-	-
228420-025	1"	8/100	-	-
228420-032	1 1/4"	9/100	-	-
228420-040	1 1/2"	9/100	-	-
228420-050	2"	9/100	-	-

- Próximo lanzamiento
Release soon

CÓDIGO CODE	_____	_____	_____	_____
MEDIDA SIZE	_____	_____	_____	_____
ROSCA VARILLA ROD THREAD	_____	_____	_____	_____
DIÁMETRO DIAMETER	_____	_____	_____	_____
ENCAJADO GRANDE MASTER CARTON	_____	_____	_____	_____
ENCAJADO INTERMEDIO INNER CARTON	_____	_____	_____	_____

228421



Boya de plástico esférica
para válvula de flotador
con varilla roscada

Spheric plastic buoy for
float valve with threaded
rod

EAN CODE

228421-015	1/2"	6/100	110mm	-	-
228421-020	3/4"	7/100	130mm	-	-
228421-025	1"	8/100	150mm	-	-
228421-03240	1 1/4" - 1 1/2"	9/100	200mm	-	-
228421-050	2"	9/100	230mm	-	-

228431



Boya de plástico mixta
para válvula de flotador
con varilla plana y roscada

Mixed plastic buoy for
float valve with flat and
threaded rod

EAN CODE

228431-015	1/2"	6/100	120mm	-	-
228431-020	3/4"	7/100	120mm	-	-
228431-025	1"	8/100	150mm	-	-
228431-03240	1 1/4" - 1 1/2"	9/100	200mm	-	-
228431-050	2"	9/100	250mm	-	-



VÁLVULAS CLICK CLACK
CLICK CLACK VALVES



FICHA TÉCNICA
TECHNICAL SHEET



CÓDIGO CODE
MEDIDA SIZE
ENCAJADO GRANDE MASTER CARTON
ENCAJADO INTERMEDIO INNER CARTON

4417



Válvula click clack Ø 37mm.

Brass waste for wash basin with click-clack Ø 37mm.

EAN CODE

4417-032	1 1/4"	24	1
----------	--------	----	---

4418



Válvula click clack Ø 66mm.

Brass waste for basin with click-clack Ø 66mm.

EAN CODE

4418-032	1 1/4"	24	1
----------	--------	----	---

4419



Válvula click clack universal Ø 37mm.

Brass waste for basin with click-clack universal Ø 37mm.

EAN CODE

4419-032	1 1/4"	36	1
----------	--------	----	---

Recambios disponibles en página 224
Spare parts available page 224

8

ADHESIVOS Y SELLANTES PTFE

PTFE ADHESIVES AND SEALANTS



Presión máxima de trabajo en Bar
Maximum working pressure Bar



30

Rango de temperatura °C
Temperature range °C



-190°
370°

Resistencia a la tracción 8 n/mm²
Tensile strenght 8 n/mm²



100% PTFE virgen
100% virgin PTFE

PTFE

Densidad 0,35 g/cm³
Density 0,35 g/cm³



CÓDIGO CODE	_____
PRODUCTO PRODUCT	_____
ENCAJADO GRANDE MASTER CARTON	_____

THF ALTA PRESIÓN



THF alta presión ultrarápido THF ultrafast high pressure

IT00101	Tubo 125 ml.	25
IT00103	Bote 500 ml.	24
IT00104	Bote 500 ml. + pincel	24
IT00105	Bote 1.000 ml.	12
IT00106	Bote 1.000 ml. + pincel	12

- Tiempo de secado 30 segundos
30 secons dry
- Adhesivo PVC
PVC cement

N-30 SECADO RÁPIDO



N-30 "Presión" secado rápido N-30 'Pressure' fast curing

IT00301	Tubo 125 ml.	25
IT00302	Bote 250 ml. + pincel	24
IT00304	Bote 500 ml. + pincel	24
IT00306	Bote 1.000 ml. + pincel	12

- Tiempo de secado 90 segundos
90 secons dry
- Adhesivo PVC
PVC cement

N-40 SECADO LENTO



N-40 "Presión" secado lento N-40 'Pressure' slow curing

IT00401	Tubo 125 ml.	25
IT00404	Bote 500 ml. + pincel	24
IT00406	Bote 1.000 ml. + pincel	12

- Tiempo de secado 180 segundos
180 secons dry
- Adhesivo PVC
PVC cement

BLUETITE PVC FLEXIBLE



Bluetite adhesivo pvc flexible Bluetite solvent cement pvc flexible

IT00201	Tubo 125 ml.	25
IT00202P	Bote 250 ml. + pincel	24
IT00204	Bote 500 ml. + pincel	24
IT00206	Bote 1.000 ml. + pincel	12

- Adhesivo PVC
PVC cement
- Formato de plástico
Plastic format

LN-40



LN-40 limpiador para pvc (decapante) LN-40 cleaner for pvc (stripper)

IT00802LNP*	BOTE 250 ml.	24
IT00803LN	Bote 500 ml.	24
IT00805LN	Bote 1.000 ml.	12

- Formato de plástico
Plastic format

			CÓDIGO CODE		
			PRODUCTO PRODUCT		
			ENCAJADO GRANDE MASTER CARTON		
LIMPIADOR		Limpiador polietileno	Polyethylene cleaner	IT00805IPA	Bote 1.000 ml. 12
SELLADOR		Sellador hidráulico baja resistencia	Hydraulic sealant	IT019142	50 ml. 10
CIANOCRILATO		Cianocrilato	Cyanoacrylate	IT019C	20 cc. 12
PTFE LÍQUIDO		PTFE líquido	Liquid PTFE	IT013L75	75 ml. 12
					<ul style="list-style-type: none"> Sellado de roscas en fontanería Threaded seal in plumbing

			CÓDIGO CODE		
			PRODUCTO PRODUCT		
			ENCAJADO INTERMEDIO INNER CARTON		
			ENCAJADO GRANDE MASTER CARTON		
CINTA PTFE		Cinta de PTFE	PTFE tape	700-10	12 x 12 x 0,075 1000 10
				700-11	12 x 12 x 0,10 1000 10
				700-12	25 x 15 x 0,10 250 10
				700-13	50 x 19 x 0,10 250 10

WRAS

9

RECAMBIOS

SPARE PARTS

9

RECAMBIOS

SPARE PARTS



Maneta ergonómica con
tuerca autoblocante
Ergonomic handle with
self-locking nut

Producto 493082
Maneta acero inoxidable
para válvula PN-30 (p.220)

Product 493082
Stainless steel handle for
PN-30 ball valve (p.220)

SERIE PLATINUM PLATINUM SERIES

494081



Recambio - Maneta acero inoxidable color negro para válvula PN-40

PLATINUM

Spare part - Stainless steel black handle for PN-40 ball valve

CÓDIGO CODE		MEDIDA SIZE		ENCAJADO GRANDE MASTER CARTON		ENCAJADO INTERMEDIO INNER CARTON	
494081-1520		1/2"		240	1		
		3/4"		240	1		
494081-0025		1"		120	1		
494081-0032		1 1/4"		80	1		
494081-0040		1 1/2"		120	1		
494081-0050		2"		120	1		

SERIE GOLD GOLD SERIES

493082 ■



493080 ■



Recambio - Maneta acero inoxidable para válvula PN-30 rojo y azul

GOLD

Spare part - Stainless steel handle for PN-30 ball valve red and blue color

CÓDIGO CODE		MEDIDA SIZE		ENCAJADO GRANDE MASTER CARTON		ENCAJADO INTERMEDIO INNER CARTON	
493082-0815	493080-0815	1/4"		210	35		
		3/8"		210	35		
		1/2"		210	35		
493082-0020	493080-0020	3/4"		240	60		
493082-0025	493080-0025	1"		180	45		
493082-0032	493080-0032	1 1/4"		80	20		
493082-0040	493080-0040	1 1/2"		72	18		
493082-0050	493080-0050	2"		180	30		

SERIE SILVER SILVER SERIES

492552 ■



492550 ■



Recambio - Maneta color azul o rojo para válvula PN-25

SILVER

Spare part - Handle blue or red color for PN-25 ball valve

492552-0820	492550-0820	1/4"		180	30		
		3/8"		180	30		
		1/2"		180	30		
		3/4"		180	30		
492552-0025	492550-0025	1"		140	35		
492552-0032	492550-0032	1 1/4"		80	20		
492552-0040	492550-0040	1 1/2"		80	20		
492552-0050	492550-0050	2"		120	20		

FILTROS FILTERS

4120R



Recambio - Tamiz inoxidable para filtro en Y para 4120

EAN CODE

Spare part - Stainless steel sieve for Y strainer 4120

CÓDIGO CODE		MEDIDA SIZE		ENCAJADO GRANDE MASTER CARTON		ENCAJADO INTERMEDIO INNER CARTON	
4120-015R		1/2"		400	100		
4120-020R		3/4"		200	50		
4120-025R		1"		200	50		
4120-032R		1 1/4"		96	24		
4120-040R		1 1/2"		44	11		
4120-050R		2"		24	6		

VÁLVULAS DE MARIPOSA BUTTERFLY VALVES

51224



Recambio - Reductor manual para las válvulas de mariposa

Spare part - Hand wheel gear box for butterfly valves

CÓDIGO CODE	MEDIDA SIZE	ENCAJADO GRANDE MASTER CARTON
51224-040100	1 1/2" - 4"	1
51224-125150	5" - 6"	1
51224-200	8"	1
51224-250	10"	1
51224-300	12"	1

SERIE 87 87 SERIES

97001



Recambio - Junta racor depósito

Spare part - Tank outlet connection gasket

CÓDIGO CODE	MEDIDA SIZE	ENCAJADO GRANDE MASTER CARTON	ENCAJADO INTERMEDIO INNER CARTON
97001-010	3/8"	1200	100
97001-015	1/2"	1000	50
97001-020	3/4"	700	50
97001-025	1"	500	20
97001-032	1 1/4"	300	10
97001-040	1 1/2"	250	10
97001-050	2"	200	10
97001-065	2 1/2"	150	10
97001-080	3"	90	10

97900



Recambio - Junta racor Barcelona

Spare part - Water-tightness gasket hose connection barcelona

97900-015	15	1200	100
97900-020	20	1000	50
97900-025	25	700	50
97900-032	32	500	10
97900-040	40	250	10
97900-050mm	60	300	10
97900-050	50	180	10

TABLA RECAMBIO JUNTAS (RACOR BARCELONA) GASKETS SPARE PARTS TABLE (HOSE BARCELONA)

RACOR BARCELONA	HOSE BARCELONA	JUNTA O RING	MEDIDA SIZE
87560-020			
87561-015		DN15	97900-015
87562-1520			
87560-025			
87561-020		DN20	97900-020
87562-2025			
87560-030			
87561-025		DN25	97900-025
87562-2530			
87560-035			
87560-040		DN32	97900-032
87561-032			
87562-3235			
87560-045			
87561-040		DN40	97900-040
87562-4045			
87560-050		50mm.	97900-050mm.
87560-060			
87561-050		DN50	97900-050
87562-5060			

SERIE 88
88 SERIES

CÓDIGO CODE _____
MEDIDA SIZE _____
ENCAJADO GRANDE MASTER CARTON _____
ENCAJADO INTERMEDIO INNER CARTON _____

889901



Recambio - Cono de presión interno. Compatible con Serie 88 y Serie 99.

Internal pressure cone. Compatible with 88 Series and 99 Series.

EAN CODE

889901-020	20	250	10
889901-025	25	150	10
889901-032	32	100	10
889901-040	40	50	10
889901-050	50	40	10
889901-063	63	36	1

88900



Recambio - Anillo compresión plástico. Compatible con Serie 88.

Spare part - Plastic compression ring. Compatible with 88 Series.

88900-020	20	1000	25
88900-025	25	600	25
88900-032	32	320	10
88900-040	40	200	10
88900-050	50	160	10
88900-063	63	90	10

88901



Recambio - Anillo compresión latón. Compatible con Serie 88.

Spare part - Brass compression ring. Compatible with 88 Series.

88901-020	20	900	25
88901-025	25	500	25
88901-032	32	280	10
88901-040	40	160	10
88901-050	50	120	10
88901-063	63	70	10

88902



Recambio - Junta tórica NBR 70. Compatible con Serie 88.

Spare part - O'ring NBR 70. Compatible with 88 Series.

88902-020	20	1000	25
88902-025	25	600	25
88902-032	32	320	10
88902-040	40	200	10
88902-050	50	160	10
88902-063	63	90	10

89900



Recambio - Juego de cuatro tornillos y arandelas. Compatible con Serie 89.

Spare part - Set of four bolts and washers. Compatible with 89 Series.

89900-01	75	150	1
89900-02	90-110	130	1

- Tornillos en acero inoxidable
Stainless steel bolts

SERIE 89
89 SERIES

89902



Recambio - Junta tórica de estanqueidad NBR70. Compatible con Serie 89.

Spare part - Water-tightness o'ring NBR70. Compatible with 89 Series.

89902-075	75	1	1
89902-090	90	1	1
89902-110	110	1	1

SERIE 99 99 SERIES

CÓDIGO CODE
MEDIDA SIZE
ENCAJADO GRANDE MASTER CARTON
ENCAJADO INTERMEDIO INNER CARTON

99901



Recambio - Anillo compresión latón. Compatible con Serie 99.

Spare part - Brass compression ring. Compatible with 99 Series.

99901-020	20	1200	25
99901-025	25	750	25
99901-032	32	420	10
99901-040	40	230	10
99901-050	50	150	10
99901-063	63	100	10

99902



Recambio - Junta tórica NBR 70. Compatible con Serie 99.

Spare part - O'ring NBR 70. Compatible with 99 Series.

99902-020	20	1	
99902-025	25	1	
99902-032	32	1	
99902-040	40	1	
99902-050	50	1	
99902-063	63	1	

SERIE 66/67 66/67 SERIES

66901 67901



Recambio - Anillo de compresión

Spare part - Compression ring

WRAS
EAN CODE

66901-015	15	2500	250
66901-018	18	2000	100
66901-022	22	1500	100
66901-028	28	800	50
67901-008	8	4000	400
67901-010	10	3500	350
67901-012	12	3000	300
67901-015	15	2500	250
67901-018	18	2000	100
67901-022	22	1500	100
67901-028	28	800	50

MT PRESS MT PRESS

JE

Recambio - Junta EPDM

Spare part - O-ring EPDM

DVGW



CÓDIGO CODE	MEDIDA SIZE	📦	📦
JE015	15	5000	500
JE018	18	5000	500
JE022	22	3000	300
JE028	28	3000	300
JE035	35	3000	300
JE042	42	2000	200
JE054	54	2000	200
JE076	76	150	15
JE088	88	150	15
JE108	108	150	15

JV

Recambio - Junta FKM

Spare part - O-ring FKM

DVGW



CÓDIGO CODE	MEDIDA SIZE	📦	📦
JV015	15	5000	500
JV018	18	5000	500
JV022	22	3000	300
JV028	28	3000	300
JV035	35	3000	300
JV042	42	2000	200
JV054	54	2000	200
JV076	76	150	15
JV088	88	150	15
JV108	108	150	15

MAC3
MAC3

CÓDIGO CODE _____
MEDIDA SIZE _____

SUPER SIMPLEX E

Recambio -
Supersimplex E

Spare part -
Supersimplex E

VS00E00G000 230v



VÁLVULAS DE DESCARGA
Y LLENADO
FLUSH AND FILL VALVES

CÓDIGO / CODE _____
MEDIDA / SIZE _____
ENCAJADO GRANDE / MASTER CARTON _____
ENCAJADO INTERMEDIO / INNER CARTON _____

55015



Recambio - Junta y
tornillos

Spare part - Flat gasket
and bolts

55015 - 150 1

- Tornillos de acero inoxidable
Stainless steel screws

EAN CODE

VÁLVULAS CLICK CLACK
CLICK CLACK VALVES

CÓDIGO / CODE _____
MEDIDA / SIZE _____
ENCAJADO GRANDE / MASTER CARTON _____
ENCAJADO INTERMEDIO / INNER CARTON _____

449117



Recambio - Junta tórica
para 4417, 4418 y 4419.

Spare part - O'ring for
4417, 4418 AND 4419

449117-037 1 1/4" 3000 1

EAN CODE

449017



Recambio - Junta silicona
para 4417 y 4418

Spare part - Silicone
gasket for 4417 y 4418

449017-032 1 1/4" 500 1

EAN CODE

VÁLVULA COMPUERTA CIERRE ELÁSTICO RESILIENT WEDGE GATE VALVE

5123



Recambio - Cuadradillo para 5113

Spare part - Square handle for 5113

CÓDIGO CODE			
MEDIDA SIZE			
ENCAJADO GRANDE MASTER CARTON			
5123-040080M	DN40 - DN80	1	
5123-100125M	DN100 - DN125	1	
5123-150250M	DN150 - DN250	1	
5123-300350M	DN300 - DN350	1	

5135



Recambio - Volante para 5143

Spare part - Handwheel for 5143

5135	3/4" - 2"	1	
------	-----------	---	--

- El volante es una opción, no se adjunta con la 5143
Handwheel is an option, it is not included with 5143

MANGUITOS ELÁSTICOS EXPANSION JOINS

5126



Recambio - Pasador para manguitos elásticos simple onda

Spare part - Control rod set elastic joints single sphere

CÓDIGO CODE			
MEDIDA SIZE			
ENCAJADO GRANDE MASTER CARTON			
5126-100	4"	1	
5126-125	5"	1	
5126-150	6"	1	
5126-200	8"	1	
5126-250	10"	1	
5126-300	12"	1	

- Compuesto por: dos soportes triángulo, dos varillas roscada, dos tuercas, dos arandelas y dos juntas planas
Kit: two triangle supports, two threaded rods, two nuts, two washers and two flat gaskets.



FICHA TÉCNICA
TECHNICAL SHEET

CONDICIONES DE VENTA

SALES CONDITIONS

CONDICIONES VÁLIDAS SÓLO PARA ESPAÑA

VALID CONDITIONS ONLY IN SPAIN

PRECIOS Y CONDICIONES DE PAGO

Contado: reposición o recibo a 15 días dto. P.P. 1%.

Forma de pago: plazo máximo 60 días fecha factura.

IVA: se cargará el % correspondiente, según reglamentación en vigor.

Tarifas de precios: nos comprometemos a comunicar a nuestros clientes cualquier cambio que se produzca en las tarifas del catálogo a través de las usuales vías de comunicación: web, email, correo.

PEDIDOS

Con el fin de evitar confusiones y ofrecer un mejor servicio, será condición indispensable por parte del comprador indicar la referencia MT Business Key, S.L. en su pedido, incluidos los dígitos de la medida. Cada pedido enviado a MT Business Key, S.L. genera una expedición para el cliente, recomendamos que preparen sus pedidos completos para optimizar los gastos de transporte. Todos los pedidos serán confirmados vía email y, salvo notificación de lo contrario, seguirá su curso sin derecho a posteriores modificaciones.

Pedido mínimo aceptable: 150€ netos.

Cantidades mínimas: las cantidades mínimas aceptables corresponderán a las del embalaje interior de la caja.

Embalajes: incluidos.

PORTES

Se cargarán 7€ en factura para pedidos inferiores a los 400 € netos (Península y Baleares). Para el resto del territorio se cargarán los portes en factura aplicando la tarifa reducida de nuestra agencia de transportes.

España (Península) e Islas Baleares: incluidos en pedidos superiores a 400€ netos.

Melilla: incluidos en pedidos superiores a 1200€ netos.

Islas Canarias: incluidos en pedidos superiores a 800€ netos.

SERVICIOS POSTVENTA OFRECIDOS POR MT:

Reclamaciones: cualquier reclamación deberá formularse dentro de los treinta (30) días siguientes a la fecha de factura, rechazándose las efectuadas después de dicho plazo límite.

Periodo de desistimiento: conforme la Ley General para la Defensa de los Consumidores y Usuarios, el comprador dispone de catorce (14) días naturales para devolver la totalidad o parte del pedido sin penalización alguna, a contar desde la fecha de factura.

Devoluciones: no se aceptará ninguna devolución de material sin antes existir la conformidad expresa, mediante el número de devolución facilitado, por la empresa (véase nuestra política y proceso de devolución en la web). El plazo máximo admitido para devolver material no conforme es de sesenta (60) días, a contar desde la fecha de factura.

Garantía: todos nuestros productos tienen 2 años de garantía según establece la Ley vigente. Si el defecto se manifiesta pasados los 6 meses después de su compra se requerirá una revisión técnica y/o pericial por nuestro departamento de calidad con tal de poder aplicar su derecho a la garantía.

La garantía queda limitada pura y simplemente al reemplazo de las piezas, una vez reconocidas materialmente defectuosas por nuestro personal técnico sin indemnización.

Litigios: en caso de litigio ambas partes aceptan someter sus diferencias a los juzgados y tribunales de Barcelona.

MT Business Key S.L. se reserva la facultad de cambiar en todo o en parte el diseño, materiales, embolsado, encajado y precios de cualquiera de sus productos.

CONDICIONES VÁLIDAS SÓLO PARA EXPORTACIÓN

VALID CONDITIONS ONLY FOR EXPORT

RATES AND FREIGHTS CONDITIONS

Cash: bank transfer. For advance payments discount 1%.

Credit: max. 60 days invoice date after Bank Insurance Approval.

Freight Conditions: EXW Incoterms 2010, unless other conditions are granted.

Price rates: MT Business Key, S.L. commits to communicate to our customers any changes applied on tariffs through usual means of communication: web & email.

ORDERS

Minimum order amount: 500€ netto.

Minimum quantities: the minimum acceptable quantities will be equal to inner packing quantities.

Packing: included.

CUSTOMER SERVICE

Claims: all claims will be granted within 45 days after date of Invoice. After this period MT Business Key, S.L. can't promise any resolution.

Warranty: all our products are new and are covered for 2 years.

Return policy: all material returned will be at freight paid. All products must be in original conditions and clearly identified. If after inspection in our warehouse these products are not in original condition, we might apply a devaluation fee.

CONDITIONS INSIDE EU:

Even though all purchases are covered by our extended 14-day exchange or refund promise, no material return will be accepted without the conformity of the commercial department.

No unwanted material returned will be accepted after 60 days invoice's date. All unwanted material returned after 14 days of date of invoice and before maximum period of acceptance (60 days) will be charged 30% of demerit.

CONDITIONS OUTSIDE EU:

No unwanted material returned will be accepted after 90 days Invoice's date. All unwanted material returned will be charged 30% of demerit.

Litigations: in case of litigation both sides agree to take their differences at the courts of Barcelona.

MT Business Key S.L. reserves the right to modify all or part of the design, materials, packing or prices of any of their products.



Nuevo servicio urgente 24 horas sólo para España

Para paquetería de menos de 10 kg. 7 € en factura.

Para expediciones de menos de 30 kg. 12 € en factura.

Para pedidos superiores a 30 kg de peso, consultar.

New urgent service 24 hours only in Spain

For packages of less than 10 kg. 7 € in invoice

For expeditions of less than 30 kg. 12 € in invoice

For higher orders to 30 kg weight, consult.

ÍNDICE DE REFERENCIAS

REFERENCES INDEX

REF	PAG	REF	PAG	REF	PAG	REF	PAG
001	162	0916	45	4084	16	4135G	119
002	162	0917	39	4091	17	4141	32
003	162	0918	40	40912	17	4142	29
01001	122	0919	41	4092	17	4143	30
01002	122	092	163	40922	17	4144	29
01003	123	0921	44	4093	17	4145	30
01040	122	0921G	44	40932	17	4145G	30
01041	122	0926	44	4094	17	4146	30
01090	123	096	164	40942	17	4147	30
01092	123	098	164	4097	13	4147G	30
01130	124	1010	66	40972	13	4148	30
01131	123	101010	66	4098	13	4148G	30
01132	124	11B PN16 A304L	155	40982	13	4149	32
01246	125	11B PN16 A316L	155	4099	15	4150	33
01270	125	11B PN40 A304L	156	4100	14	4151	33
01290	125	120	164	4101	14	4152	33
01321	127	130	165	4102	14	4153	33
01340	126	130R	165	41022	14	4154	33
01341	126	13B PN16 BSP A304L	152	4103	14	4155	33
01359	126	13B PN16 BSP A316L	152	41032	14	4156	34
01360	127	160101	131	4104	12	4157	34
01440	127	160204 AISI 304 (A2)	131	4105	15	4160	35
01441	127	160306 AISI 316 (A4)	131	4106	14	4161	28
01472	127	170811010	194	41062	14	41642	21
015004	129	170811015	194	4107	18	41642	79
015006	129	170811510	195	4108	18	4174	16
01A PN10 ISO A304L	146	170811515	195	4109	22	41742	16
01A PN10 ISO A316L	146	170821010	194	41092	22	4182	16
01A PN10 MM A304L	146	170821015	194	41093	22	4204	12
01A PN10 MM A316L	146	170821515	194	4110	22	4215	23
01A PN16 ISO A304L	148	180	164	41102	22	4221	19
01A PN16 ISO A316L	148	221	164	41103	22	4222	19
01A PN16 MM A304L	148	223	165	4111	29	4224	20
01A PN16 MM A316L	148	228410	213	4111G	29	4225	20
01A PN25 ISO A304L	150	228420	213	4113	27	4226	20
01A PN25 ISO A316L	150	228421	213	4113CE	27	4230	19
01A PN40 ISO A304L	151	228431	213	4113I	27	42642	19
01A PN40 ISO A316L	151	240	167	4114	23	42642	21
040	162	241	168	4115	23	42642	79
041	162	245	166	4116	24	4295	13
05A PN10 A304L	153	246	166	4117	24	42952	13
05A PN10 A316L	153	2510 PASO L	66	4118	24	4400	31
05A PN16 A316L	154	2510 PASO T	66	4119	24	4401	31
085	163	2642024	160	4120	35	4402	25
090	163	2642026	160	4120R	220	4404	25
0909	38	270	167	4121	30	4405	25
090R	163	280	168	4122	30	4406	25
0910	38	290	169	4123	29	4407	31
09102	38	300	169	4123G	29	4409	26
09103	38	301	169	4124	15	4410	26
09104	38	312	169	4125	29	4411	25
0911	39	321	169	41302G	119	4412	28
0912	39	340	170	41303G	119	4413	28
0913	47	341	170	4131G	118	4414	28
0914	41	40642	21	4132G	119	4415	28
09142	41	40642	79	41332G	118	4416	28
0915	41	4074	16	4133G	118	4417	214
09152	41	40742	16	4134G	118	4418	214

REF	PAG	REF	PAG	REF	PAG	REF	PAG
4419	214	5128	42	53091032	192	642130	74
4422	25	5129	63	53091120	188	642131	74
4426	25	5130	60	5320912	190	642132	74
4434	31	51302	60	5320917	183	642133	74
4435	31	5131	60	5320918	184	642134	74
449017	224	5132	46	5320919	185	642135	74
449117	224	5135	225	5324	174	642270	74
4504	12	5137	59	5325114	175	642271	75
45642	21	5140	52	53251142	179	642272	75
45642	79	5141	52	53251143	182	642273	75
4604	12	5142	57	5325115	176	642274	75
492550	220	5143	58	53251151	177	642500	75
492552	220	5144	55	5325117	186	645	81
493080	220	51442	56	5325128	187	647090	76
493082	220	51442MR	56	5325140	178	647091	76
494081	220	5144MR	55	5325144	180	647092	76
5100	172	5145	59	53251442	181	647094	76
5100912	190	51BSR	174	53291020	189	647130	77
5100917	183	51CFC	173	53291031	191	647131	77
5100918	184	51DPS	174	53291032	192	647270	77
5100919	185	51SMC	173	53291120	188	647271	77
5105114	175	5200	172	540032	172	647272	78
51051142	179	5200912	190	540052	172	647273	78
51051143	182	5200917	183	55001	210	647274	78
5105115	176	5200918	184	55002	210	647275	78
51051151	177	5200919	185	55003	210	647290	78
5105117	186	5205114	175	55004	210	647500	78
5105128	187	52051142	179	55005	211	649161	80
5105140	178	52051143	182	55006	211	649162	80
5105144	180	5205115	176	55007	211	649B	80
51051442	181	52051151	177	55015	224	649R	81
51091020	189	5205117	186	600	212	651091Q	84
51091031	191	5205128	187	6002	212	651271Q	84
51091032	192	5205140	178	601	212	651272Q	84
51091120	188	5205144	180	6400	82	6601	111
5110	61	52051442	181	640151	80	6601R	111
5113	58	52091020	189	640152	80	6602	111
5114	50	52091031	191	6402	82	6603	111
51142	51	52091032	192	6403	82	6604	112
51142MR	51	52091120	188	640B	80	6605	112
51143	52	529	170	640R	81	6606	112
5114MR	50	5300	174	641090	70	6607	112
5115	54	5300912	190	641091	70	6608	112
51151	53	5300917	183	641092	70	6609	113
51151MR	53	5300918	184	641130	71	6610	113
5115MR	54	5300919	185	641131	71	6611	113
5116	57	5305114	175	641132	71	6612	113
5117	42	53051142	179	641133	71	6650	15
5118	45	53051143	182	641134	71	66502	15
5119	45	5305115	176	641135	71	6651	15
5120	62	53051151	177	641270	70	66512	15
51202	62	5305117	186	641271	72	66901	223
5121	62	5305128	187	641272	72	6701	114
51212	62	5305140	178	641273	72	6701R	114
51224	221	5305144	180	641500	72	6702	114
5123	225	53051442	181	642090	73	6703	115
5125	57	53091020	189	642091	73	6704	115
5126	225	53091031	191	642092	73	6705	115

REF	PAG	REF	PAG	REF	PAG	REF	PAG
6706	115	871090	95	88190	102	JE	223
6707	116	871092	95	88500	102	JV	223
6708	116	871130	95	88900	222	KEY	202
6709	116	871240	95	88901	222	LIMPIADOR	217
6710	116	871241	96	88902	222	LJ1506 ANSI 150	158
6711	116	871245	96	889901	222	LN-40	216
6712	117	871246	96	89022	106	MAC3	202
6713	117	871270	96	89042	106	MAC5	202
8090	133	871280	96	89062	106	MAP115MLS4	82
80902	133	871290	97	89102	106	MC SWITCH	204
8092	133	87130	86	89122	106	N-30 SECADO RAPIDO	216
8120	133	871300	96	89142	107	N-40 SECADO LENTO	216
8130	134	87130R	86	89162	107	PACK MAP 2L19	130
8132	134	87132	86	89202	107	PTFE LIQUIDO	217
8149	134	871500	95	89900	222	QUICK STOP	203
8150	134	871529	97	89902	222	S09014	140
8180	135	871531	97	91020	40	S09016	140
82130	94	87180	87	91031	43	S09046	144
82220	94	87240	87	91032	43	S13014	141
82270	94	87241	87	91120	40	S13016	141
8240	135	87245	88	97001	221	S13046	144
8241	136	87246	88	97091	109	S24014	142
8245	137	87270	88	97130	108	S24016	143
8270	135	87271	88	97131	108	S24046	145
8280	136	87272	89	97132	108	S29014	144
8290	137	87280	89	97270	108	S29016	144
8300	137	87290	89	97280	108	S29046	145
8312	138	87300	89	97900	221	S29614	142
8330	138	87315	90	98010	110	S29616	142
8340	138	87318	90	98020	110	S29646	145
8341	138	87340	90	98090	110	S525604	157
8399	139	87341	90	98110	110	S525606	157
8400	198	873412	91	99010	103	SBK4254	130
8500	198	87500	92	99020	103	SBKUAP4	130
8531	139	87529	91	99030	103	SBM	130
8599	198	87530	91	99050	103	SELLADOR	217
8600	199	87531	91	99090	103	S01506 ANSI 150	158
8601	139	87532	91	99110	104	SONDA	206
8602	139	87533	91	99120	104	SS09016	140
86090	98	87534	97	99130	104	SS13016	141
86092	98	87550	92	99150	104	SS24016	143
86130	98	87551	92	99170	104	SSKMN	130
86180	98	87560	93	99190	104	SUPER SIMPLEX E	204
86243	99	87561	93	99500	105	SUPER SIMPLEX E	224
86270	99	87562	93	99901	223	SW1506 ANSI 150	158
86301	99	87563	92	99902	223	THF ALTA PRESION	216
86359	99	87570	92	AGMA	202	UAP432CFM	130
86361	100	87575	92	BL1506 ANSI 150	158	WN1506 ANSI 150	158
86362	100	8799	198	BLUETITE PVC FLEXIBLE	216		
86363	100	8800	199	BPLP	130		
86472	98	88010	101	CIANOCRILATO	217		
87001	85	88030	101	CINTA PTFE	217		
87002	85	88050	101	E POWER	205		
87090	85	88090	101	E-FLY	203		
87090R	85	88110	101	ELECTRO SONDA Q	206		
87092	85	88130	102	HCW-MM	205		
87093	86	88150	102	HCW-MT HCA-MT	205		
87098	86	88170	102	HCW-TT HCA-TT	206		

ANEXO

ANNEX

DICCIONARIO TÉCNICO FORMACIÓN BÁSICA DE CONCEPTOS Y PRODUCTOS

CONCEPTOS

DN

Abreviación de Diámetro Nominal. Indica el diámetro interior de paso del fluido por dentro de tuberías, válvulas o accesorios.

PN

Abreviación de Presión Nominal. Indica la presión interior máxima de trabajo en condiciones de temperatura ambiente y presión exterior atmosférica. El límite de presión de trabajo es una curva que va decreciendo en función del aumento de temperatura. La correcta aplicación de una válvula se realiza primero con la determinación de las condiciones de temperatura y presión y su comprobación de que el punto de trabajo siga dentro de las condiciones mecánicas de funcionamiento de esta.

PÉRDIDA DE CARGA

Disminución de la energía dinámica del fluido producido por la fricción con las paredes, su propia fricción entre sus partículas. Los cambios bruscos de dirección o de diámetro aumentan las pérdidas de carga de manera significativa.

GOLPE DE ARIETE

Fenómeno de aumento excesivo de la presión producido en las instalaciones hidráulicas cuando hay un cierre brusco del caudal del fluido. Es un fenómeno peligroso pues las presiones pueden aumentar muy por encima de las presiones nominales de los componentes y producir roturas en tuberías, accesorios y/o válvulas.

La forma de evitar estos golpes de ariete es ralentizar el cierre de las válvulas o instalar algún mecanismo que pueda absorber el exceso de presión (Vasos de expansión, dispositivos antiariete como el de MT modelo 4160).

PASO TOTAL

Una válvula se puede considerar de Paso Total o Paso Completo cuando el paso del fluido es igual a su DN (Diámetro nominal). Según UNE-EN-13828.

PASO REDUCIDO

Una válvula se puede considerar de Paso Reducido cuando el paso del fluido es una medida inferior a su DN (diámetro nominal). Según UNE-EN-13828.

ESTANQUEIDAD

Concepto que nos indica que no pasa fluido a través de la válvula en posición de cierre ni por cualquier otro punto (eje, unión cuerpo-tapa, etc).

PAR DE GIRO

Fuerza medida en Nm que se ejerce para la apertura y cierre de la válvula. Es importante su valor para poder dimensionar correctamente un actuador. Las condiciones de trabajo, presión, temperatura, presión diferencial, densidad del fluido y viscosidad del fluido puede modificar significativamente el par de giro por lo que como mínimo se debe de tener un margen de seguridad del 30%.

TECHNICAL DICTIONARY BASIC TRAINING OF CONCEPTS AND PRODUCTS

CONCEPTS

DN

Abbreviation of Nominal Diameter. Indicates the internal diameter of fluid passage through pipes, valves or fittings.

PN

Abbreviation of Nominal Pressure. Indicates the maximum internal working pressure under ambient temperature and atmospheric external pressure. The working pressure limit is a curve that decreases depending on the temperature increase. The correct application of a valve is first carried out with the determination of the temperature and pressure conditions and its verification that the working point remains within its mechanical operating conditions.

HEAD LOSS

Reduction of the dynamic energy of the fluid produced by friction with the walls, its own friction between its particles. Sudden changes in direction or diameter increase load losses significantly.

WATER HAMMER

Phenomenon of excessive increase of the pressure produced in the hydraulic installations when there is an abrupt closure of the fluid flow. It is a dangerous phenomenon because the pressures can increase well above the nominal pressures of the components and cause breaks in pipes, fittings and / or valves.

The way to avoid these water hammers is to slow down the closing of the valves or install some mechanism that can absorb excess pressure (expansion vessels, anti-cracking devices such as MT model 4160).

FULL BORE

A valve can be considered as Total Pass or Full Pass when the fluid flow is equal than its DN (Nominal Diameter). According to UNE-EN-13828.

REDUCED BORE

A valve can be considered a Reduced Pass when the fluid flow is one size smaller than its DN (Nominal Diameter). According to UNE-EN-13828.

SEALING

Concept that indicates that no fluid passes through the valve in the closed position or any other point (stem, body-cover joint, etc).

TORQUE

Force measured in Nm used to open or closing the valve. Its value is important in order to determinate the correct size for actuator. The working conditions, pressure, temperature, differential pressure, fluid density and fluid viscosity can significantly change the torque so that at least a safety margin of 30% must be had.

MATERIALES

HIERRO

Metal común frágil y con poca resistencia de la dureza y oxidación. En nuestro caso, lo galvanizamos (tratamiento químico), para darle una mayor resistencia a la oxidación.

LATÓN

El latón es una aleación de Cobre y Zinc. Muy usado en valvulería para edificación por su facilidad de manipulación combinada a su características mecánicas y su resistencia a la oxidación.

Propiedades:

- Buena resistencia a la oxidación.
- Excelente mecanización en frío.
- Excelente capacidad de recubrirse, como niquelados, galvanizados y cromados
- Excelente soldabilidad.

Existen diferentes tipos de latones, las normas que los definen son la EN-12164, EN-12165. La tendencia actual en Europa es la de cambiar a latones tipo DZR con mayores propiedades oxidantes y latones con menores o nulas cantidades de plomo.

ACERO INOXIDABLE

Los productos de MT utilizan básicamente dos tipos de Aceros Inoxidable. Se usan para válvulas que la exigencia mecánica alta, y el fluido y ambiente son corrosivos.

A304, A304L: Acero Inoxidable Austenítico con unas buenas propiedades oxidante.

A316, A316L: Acero Inoxidable Austenítico con unas mejores propiedades oxidante que el A304 por la adición de Molibdeno.

Propiedades:

- Excelente resistencia a la oxidación.
- Buena mecanización en frío.
- Buena soldabilidad en las versiones "L" de bajo contenido en carbono (A304L y A316L)
- Muy buenas propiedades mecánicas. Gran tenacidad.

Las condiciones mecánicas de estos aceros pueden variar según la forma de enfriamiento y por los tratamientos térmicos. La norma EN-10088 los describe.

FUNDICIÓN GRIS

Aleación de hierro, carbono y otros elementos en menores cantidades. Se usa para válvulas que la exigencia mecánica no sea grande, y el fluido y ambiente no son corrosivos.

Propiedades:

- Baja resistencia a la oxidación.
- Baja dureza.
- Fragilidad media.
- Buenas propiedades mecánicas.
- Excelente mecanización en frío.

Las válvulas de fundición gris van recubiertas por pinturas epoxi para mejorar notablemente su resistencia a la oxidación.

FUNDICIÓN NODULAR O DÚCTIL

Aleación de hierro, carbono y otros elementos en menores cantidades. Aumento de la Dureza y la resistencia a la fatiga.

Se usa para válvulas que la exigencia mecánica es medias, y el fluido y ambiente no son corrosivos.

Propiedades:

- Baja resistencia a la oxidación.
- Mejora la dureza de la fundición gris.
- Mejora la fragilidad de la fundición gris.
- Buenas propiedades mecánicas, mejores que la fundición gris.
- Excelente mecanización en frío.

Las válvulas de fundición dúctil también van recubiertas por pinturas epoxi para mejorar notablemente su resistencia a la oxidación.

ACERO AL CARBONO

Aleación de hierro con carbono. A diferencia de los aceros inoxidable tiene pocos elementos aleados. Son el tipo de aceros más producidos a nivel mundial.

Se usa para válvulas que necesitan unas propiedades mecánicas exigentes.

Propiedades:

- Baja resistencia a la oxidación.
- Mejora la dureza de la fundición gris.
- Mejora la fragilidad de la fundición gris.
- Buenas propiedades mecánicas, mejores que la fundición gris.
- Buena mecanización en frío.

Las válvulas de acero al carbono suelen protegerse con aceites y algunas con pintura epoxi para aumentar su resistencia a la oxidación.

NBR

Caucho de Nitrilo Butadieno (**Nitrile Butadiene Rubber**). Elastómero procedente de caucho.

Propiedades:

- Compatible con hidrocarburos, petróleo y gasóleos.
- Compatible con agua para suministro humano.
- Las temperaturas de utilización van de los -20°C a los 80°C
- Gran resistencia a las deformaciones.
- Buena resistencia a la abrasión.

Algunas válvulas lo usan para sellar el eje en forma de junta tórica o en junta plana.

EPDM

Etileno Propileno Dieno tipo **M**, elastómero sintético.

Propiedades:

- No es compatible con hidrocarburos, petróleo y gasóleos.
- Compatible con agua para suministro humano.
- Las temperaturas de utilización van de los -20°C a los 120°C.
- Gran resistencia a las deformaciones.
- Buena resistencia a la abrasión.

Algunas válvulas lo usan para sellar el eje en forma de junta tórica o en junta plana.

FKM

Elastómero fluoropolímero.

Propiedades:

- Compatible con hidrocarburos, petróleo y gasóleos.
- Compatible con agua para suministro humano.
- Las temperaturas de utilización van de los -20°C a los 180°C.
- Gran resistencia a las deformaciones.
- Buena resistencia a altas temperaturas.
- Se puede usar como cierre para válvulas en instalaciones de solar térmica.

Algunas válvulas lo usan para sellar el eje en forma de junta tórica o en junta plana.

PTFE

Elastómero sintético, **politetrafluoretileno**.

Propiedades:

- Compatible con la mayoría de químicos.
- Compatible con agua para suministro humano.
- Las temperaturas de utilización va de los -270°C a los 280°C
- Buena resistencia a temperaturas cercanas al cero absoluto y a altas temperaturas.
- Es el material con el menor coeficiente de fricción conocido.
- Se puede usar como cierre para válvulas en instalaciones de solar térmica.
- Fácil mecanización.
- Se puede mezclar con grafito o fibra de vidrio para mejorar sus propiedades mecánicas.

Algunas válvulas lo usan para sellar el eje en forma de junta plana.

MATERIALS

IRON

Common metal fragile and with little resistance to hardness and oxidation. In our case, we galvanize it (chemical treatment), to give it greater resistance to oxidation.

BRASS

Brass is an alloy of Copper and Zinc. Widely used in building valves for ease handling combined with its mechanical properties and oxidation resistance.

Properties:

- Good oxidation resistance.
- Excellent cold machining.
- Excellent coating ability, such as nickel plated, galvanized and chrome plated.
- Excellent weldability.

There are different types of brass, the standards defining them are EN-12164, EN-12165. The current trends in Europe are to switch to brass type DZR with higher oxidizing properties and brass with less or no lead content.

STAINLESS STEEL

MT products use basically two types of stainless steels. They are used for valves with high mechanical requirements, and the fluid and environment are corrosive.

A304, A304L: Austenitic Stainless Steel with good oxidizing properties.

A316, A316L: Austenitic Stainless Steel with better oxidizing properties than A304 by the addition of Molybdenum.

Properties:

- Excellent resistance to oxidation.
- Good cold machining.
- Good weldability in low carbon "L" versions (A304L and A316L)
- Very good mechanical properties. Great tenacity.

The mechanical conditions of these steels may vary depending on the form of cooling and the heat treatment. The standard EN-10088 describes them.

CAST IRON

Alloying of iron, carbon and other elements in smaller quantities.

It's used for valves where the mechanical requirement is not large and the fluid and environment are not corrosive. Properties:

- Low resistance to oxidation.
- Low hardness.
- Medium fragility.
- Good mechanical properties.
- Excellent cold machining.

Cast iron valves are coated with epoxy paint to significantly improve their resistance to oxidation.

NODULAR OR DUCTILE IRON

Alloying of iron, carbon and other elements in smaller quantities. Increased hardness and fatigue resistance than cast iron.

It is used for valves whose mechanical requirements are average, and the fluid and environment are not corrosive.

Properties:

- Low resistance to oxidation.
- Improves the hardness of the gray foundry.
- Improves the fragility of the gray foundry.
- Good mechanical properties, better than the gray foundry.
- Excellent cold machining.

Ductile iron valves are also coated with epoxy paints to significantly improve their oxidation resistance.

CARBON STEEL

Iron alloy with carbon. Unlike stainless steels it has few alloyed elements. They are the most produced type of steels in the world.

It is used for valves that require demanding mechanical properties.

Properties:

- Low resistance to oxidation.
- Improves the hardness of the gray foundry.
- Improves the fragility of the gray foundry.
- Good mechanical properties, better than the gray foundry.
- Good cold machining.

Carbon steel valves are usually protected with oils and some with epoxy paint to increase their resistance to oxidation.

NBR

Nitrile **B**utadiene **R**ubber. Elastomer from rubber.

Properties:

- Compatible with hydrocarbons, oil and diesel.
 - Compatible with water for human supply.
 - The operating temperatures range from -20°C to 80°C.
 - High resistance to deformations.
 - Good abrasion resistance.
- Some valves use it to seal the shaft in the form of a O-ring or a flat joint.

EPDM

Ethylene **P**ropylene **D**iene type **M**, synthetic elastomer.

Properties:

- Not compatible with hydrocarbons, oil and gas.
 - Compatible with water for human supply.
 - The operating temperatures range from -20°C to 120°C.
 - High resistance to deformations.
 - Good abrasion resistance.
- Some valves use it to seal the shaft in the form of a O-ring or a flat joint.

FKM

Fluoropolymer elastomer.

Properties:

- Compatible with hydrocarbons, oil and diesel.
 - Compatible with water for human supply.
 - Use temperatures range from -20°C to 180°C.
 - High resistance to deformations.
 - Good resistance to high temperatures.
- Can be used as a shutoff for valves in solar thermal installations.
- Some valves use it to seal the shaft in the form of a O-ring or a flat joint.

PTFE

Synthetic elastomer, **polytetrafluoroethylene**.

Properties:

- Compatible with most chemicals.
 - Compatible with water for human supply.
 - The operating temperatures range from -270°C to 280°C.
 - Good resistance to temperatures close to absolute zero and high temperatures.
 - It's the material with the lowest known coefficient of friction.
 - Can be used as a valve closure in solar thermal installations.
 - Easy machining.
 - Can be mixed with graphite or fiberglass to improve its mechanical properties.
- Some valves use it to seal the shaft in the form of a flat joint.

COMPUESTO QUÍMICO	FORRO INTERIOR DE LA JUNTA DE EXPANSIÓN			
	NBR	EPDM	FKM	PTFE
	NITRIL	EPDM	VITON	TEFLÓN
Acete hidráulico (petróleo)	A	X	A	A
Acete de linaza	A	B	A	A
Acete de oliva	A	C	A	A
Acetes de petróleo con alto contenido aromático	B	X	A	A
Acetes de petróleo con bajo contenido aromático	A	X	A	A
Acete de resina	A	X	A	A
Acete lubricación	A	X	A	A
Acete para transformadores	X	X	A	A
Acete para transformadores de base mineral	A	X	A	A
Acetes vegetales	A	X	A	A
Acetaldehído D	X	B	A	A
Acetato	X	A	X	A
Acetato de butilo	X	B	X	A
Acetato de etilo	X	B	X	A
Acetileno	A	A	A	A
Acetona	X	A	X	A
Acido Acético 5%	B	A	A	A
10%	B	A	A	A
20%	B	A	B	A
30%	B	A	B	A
50%	C	A	C	A
Glacial 99,5%	C	B	X	A
Acido acético anhidro	X	A	X	A
Acido arsénico	B	A	A	A
Acido bromhídrico, max 40°C	C	A	B	A
Acido clorhídrico 37%	X	A	-	A
Acido clorhídrico, 37%, 70°C	X	X	X	A
Acido clorhídrico diluido	C	A	A	A
Acido clorosulfónico	X	X	C	A
Acido crómico	X	C	A	A
Acido hidrofúor-silícico, 40°C	B	A	A	A
Acido fluorhídrico 50%, 40°C	X	B	A	A
Acido fluorsilícico	B	B	A	A
Acido fórmico	X	A	X	A
Acido fosfórico 45%, 40°C	C	A	A	A
85%, 40°C	X	B	A	A
Acido láctico	A	A	A	A
Acido nítrico 20%, 40°C	X	A	A	A

COMPUESTO QUÍMICO	FORRO INTERIOR DE LA JUNTA DE EXPANSIÓN			
	NBR	EPDM	FKM	PTFE
	NITRIL	EPDM	VITON	TEFLÓN
20%, 50°C	X	B	A	A
Acido nítrico 40%, 50°C	X	C	A	A
50%, 50°C	X	X	A	A
60%, 20°C	X	X	A	A
70%, 20°C	X	X	A	A
Acido nítrico fumante	X	X	C	A
Acido oleico	A	X	A	A
Acido oxálico	C	A	B	A
Acido palmítico	A	B	A	A
Acido salicílico	B	A	A	A
Acido sulfúrico < 60%	X	B	A	A
60%, 50°C	X	B	A	A
75%, 50°C	X	B	A	A
80%, 50°C	X	C	A	A
96%, 50°C	X	C	A	A
Acido sulfúrico fumante	X	X	B	A
Acido sulfuroso	C	A	A	A
Agua destilada	A	A	A	A
Agua fría	A	A	A	A
Agua fría, destilada 100 °C	B	A	A	A
Agua residual	A	B	A	A
Agua salada	A	A	A	A
Alcohol metílico	B	A	X	-
Amonio líquido	B	A	X	A
Anilina	C	B	B	A
Argón	C	A	A	A
Azufre derretido	X	B	A	A
Benceno (benzol)	X	X	A	A
Brandy	A	A	A	A
Brea 40° C	B	X	A	A
Bromo líquido	X	X	A	A
Butano	A	X	A	A
Butanol (alcohol butílico)	A	A	A	A
Cerveza	A	A	A	A
Cloruro de azufre	X	X	A	A
Cloruro de etilo	B	A	A	A
Cloruro de metileno	X	X	B	A
Cloruro metílico	X	C	A	A
Detergente	A	A	A	A
Dióxido de azufre Gas seco	X	A	A	A
Etano	A	X	A	A
Etanol (alcohol etílico)	A	A	B	A
Ethylene glycol	A	A	A	A
Eter de petróleo	B	X	A	A
Eter, éter etílico	C	X	X	A

COMPUESTO QUÍMICO	FORRO INTERIOR DE LA JUNTA DE EXPANSIÓN			
	NBR	EPDM	FKM	PTFE
	NITRIL	EPDM	VITON	TEFLÓN
Etilo glicol (Cellosolve)	C	B	C	A
Estireno 40° C	X	X	B	A
Fenol	X	C	A	A
Formaldehído	B	A	A	A
Fueloil	A	X	A	A
Furano	X	X	C	A
Furfurol	X	B	X	A
Gas amonia caliente	X	B	X	A
Gas amonio frío	A	A	X	A
Gas clorhídrico, húmedo, 40°C	X	C	C	A
Gas clorhídrico, seco, 40°C	X	C	A	A
Gas LP	A	X	A	A
Gas natural	A	X	A	A
Gas nitroso	X	C	X	B
Gasolina 100 oct 65 oct	C	X	A	A
B	B	X	A	A
Gasoil	A	X	A	A
Glicerina	A	A	A	A
Glucosa	A	A	A	A
Grasas animales	A	B	A	A
Hidrógeno	A	A	A	A
Hidróxido de amonio	C	A	B	A
Hipoclorito de calcio	C	A	A	A
Hipoclorito sódico < 10gr/l	C	A	A	A
Hipoclorito sódico > 10gr/l	X	B	A	A
Leche	A	A	A	A
Licor negro	A	X	A	A
Licor verde, licor blanco	A	A	A	A
Liquid manure	A	A	-	A
LP gas, propano	A	X	A	A
MEK Metil etil cetona	X	A	X	B
Metil isobutil cetona	X	B	X	A
Metil isopropil cetona	X	C	X	A
Nitrobenceno	X	B	B	A
Nitrógeno	A	A	A	A
Oxígeno	C	A	A	A
Ozono	X	B	A	A
Parafina de queroseno	A	X	A	A
Percloroetileno	C	X	A	A
Peróxido de hidrogeno, 3%, 40°C	B	A	A	A
30%, 20°C	C	B	A	A
90%, 20°C	C	-	B	A

COMPUESTO QUÍMICO	FORRO INTERIOR DE LA JUNTA DE EXPANSIÓN			
	NBR	EPDM	FKM	PTFE
	NITRIL	EPDM	VITON	TEFLÓN
Plating sol. W/o chromium	X	A	A	A
Potasa cáustica	C	B	C	A
Propanol, alcohol propílico	A	A	A	A
Rapeded oil	X	A	A	A
Sales férricas, no oxidantes	A	A	A	A
Sulfuro de hidrógeno, húmedo, 40°C	X	B	X	A
Sulfuro de hidrógeno, húmedo, 20° C	C	A	X	A
Sulfuro de hidrógeno, seco, 20°C	A	A	X	A
Solución de cloro 0,1 gr./l	A	A	A	A
Solución de cloro 0,1 - 1 gr./l	A	A	A	A
Solución de cloro 1-10 gr./l 40°C	B	B	-	-
Solución de cloro > 10 gr./l 40°C	C	C	-	-
Soluciones de azúcar	A	A	A	A
Soluciones de sal no oxidantes	A	A	A	A
Sosa cáustica	C	A	B	A
Turpentine	A	X	A	A
Tricloretileno 40°C	X	X	A	A
Trióxido de azufre, gas seco	X	B	A	A
Tolueno	C	X	A	A
Whisky, vino	A	A	A	A
Xileno	X	X	A	A

CÓDIGO DE CLASIFICACIÓN

- A Comportamiento excelente
- B Comportamiento bueno
- C Comportamiento regular
- X Incompatible
- Sin datos

CHEMICAL COMPOUND	INNER LINING OF THE EXPANSION JOINT			
	NBR	EPDM	FKM	PTFE
	NITRILE	EPDM	VITON	TEFLON
Hydraulic oil (petroleum)	A	X	A	A
Linseed oil	A	B	A	A
Olive oil	A	C	A	A
Petroleum oils with high aromatic content	B	X	A	A
Petroleum oils with low aromatic content	A	X	A	A
Resin oil	A	X	A	A
Oil lubrication	A	X	A	A
Transformer oil	X	X	A	A
Oil for mineral based transformers	A	X	A	A
Vegetable oils	A	X	A	A
Acetaldehyde D	X	B	A	A
Acetate	X	A	X	A
Acetate of butilo	X	B	X	A
Ethyl acetate	X	B	X	A
Acetylene	A	A	A	A
Acetone	X	A	X	A
Acetic Acid 5%	B	A	A	A
10%	B	A	A	A
20%	B	A	B	A
30%	B	A	B	A
50%	C	A	C	A
99,5% glacial	C	B	X	A
Anhydrous acetic acid	X	A	X	A
Arsenic acid	B	A	A	A
Hydrobromic acid, max 40°C	C	A	B	A
37% hydrochloric acid	X	A	-	A
37% hydrochloric acid, 70°C	X	X	X	A
Disolved hydrochloric acid	C	A	A	A
Chlorosulfonic acid	X	X	C	A
Chromic acid	X	C	A	A
Hydrofluorsilicic acid, 40°C	B	A	A	A
50% hydrofluoric acid, 40°C	X	B	A	A
Fluorsilicic Acid	B	B	A	A
Formic acid	X	A	X	A
45% phosphoric acid, 40 °C	C	A	A	A
85%, 40°C	X	B	A	A
Lactic acid	A	A	A	A
Nitric acid 20%, 40°C	X	A	A	A
20%, 50°C	B	A	A	A
40% nitric acid, 50°C	X	B	A	A

CHEMICAL COMPOUND	INNER LINING OF THE EXPANSION JOINT			
	NBR	EPDM	FKM	PTFE
	NITRILE	EPDM	VITON	TEFLON
50%, 50°C	X	X	A	A
60%, 20°C	X	X	A	A
70%, 20°C	X	X	A	A
Nitric acid smoking	X	X	C	A
Oleic acid	A	X	A	A
Oxalic acid	C	A	B	A
Palmitic acid	A	B	A	A
Salicylic acid	B	A	A	A
<60% sulfuric acid	X	B	A	A
60%, 50°C	X	B	A	A
75%, 50°C	X	B	A	A
80%, 50°C	X	C	A	A
96%, 50°C	X	C	A	A
Sulfuric Acid Smoking	X	X	B	A
Sulfurous acid	C	A	A	A
Distilled water	A	A	A	A
Cold water	A	A	A	A
Cold water, distilled 100 °C	B	A	A	A
Residual water	A	B	A	A
Saltwater	A	A	A	A
Methyl alcohol	B	A	X	-
Liquid ammonium	B	A	X	A
Aniline	C	B	B	A
Argon	C	A	A	A
Melted sulfur	X	B	A	A
Benzene (Benzol)	X	X	A	A
Brandy	A	A	A	A
40°C brea	B	X	A	A
Liquid bromine	X	X	A	A
Butane	A	X	A	A
Butanol (Butyl alcohol)	A	A	A	A
Beer	A	A	A	A
Sulfur chloride	X	X	A	A
Ethyl chloride	B	A	A	A
Methylene chloride	X	X	B	A
Methyl chloride	X	C	A	A
Detergent	A	A	A	A
Sulfur dioxide, dry gas	X	A	A	A
Ethane	A	X	A	A
Ethanol (ethyl alcohol)	A	A	B	A
Ethylene glycol	A	A	A	A
Petroleum ether	B	X	A	A
Ether, ethyl ether	C	X	X	A
Ethylene	X	C	B	A
Ethyl Glycol (Cellosolve)	C	B	C	A

CHEMICAL COMPOUND	INNER LINING OF THE EXPANSION JOINT			
	NBR	EPDM	FKM	PTFE
	NITRILE	EPDM	VITON	TEFLON
Styrene 40°C	X	X	B	A
Phenol	X	C	A	A
Formaldehyde	B	A	A	A
Fueloil	A	X	A	A
Furan	X	X	C	A
Furfurol	X	B	X	A
Hot ammonia gas	X	B	X	A
Cold ammonium gas	A	A	X	A
Hydrochloric gas, humid, 40°C	X	C	C	A
Hydrochloric gas, dry, 40°C	X	C	A	A
LP gas	A	X	A	A
Natural gas	A	X	A	A
Nitrous gas	X	C	X	B
Petrol 100 Oct	C	X	A	A
65 oct	B	X	A	A
Gasoil	A	X	A	A
Glycerin	A	A	A	A
Glucose	A	A	A	A
Animal fats	A	B	A	A
Hydrogen	A	A	A	A
Ammonium hydroxide	C	A	B	A
Calcium hypochlorite	C	A	A	A
Sodium hypochlorite <10 gr/l	C	A	A	A
Sodium hypochlorite > 10 gr/l	X	B	A	A
Milk	A	A	A	A
Black liquor	A	X	A	A
Green liquor, white liquor	A	A	A	A
Liquid manure	A	A	-	A
LP gas, propane	A	X	A	A
MEK Methyl Ethyl Ketone	A	X	X	B
Methyl isobutyl ketone	X	B	X	A
Methyl Isopropyl ketone	X	C	X	A
Nitrobenzene	X	B	B	A
Nitrogen	A	A	A	A
Oxygen	C	A	A	A
Ozone	X	B	A	A
Kerosene paraffin	A	X	A	A
Perchlorethylene	C	X	A	A
Hydrogen peroxide, 3%, 40°C	B	A	A	A
30%, 20°C	C	B	A	A
90%, 20°C	C	-	B	A
Plating sol. W/o chromium	X	A	A	A

CHEMICAL COMPOUND	INNER LINING OF THE EXPANSION JOINT			
	NBR	EPDM	FKM	PTFE
	NITRILE	EPDM	VITON	TEFLON
Caustic potash	C	B	C	A
Propanol, propyl alcohol	A	A	A	A
Rapeseed oil	X	A	A	A
Ferric salts, non-oxidizing	A	A	A	A
Hydrogen sulphide, wet, 40°C	X	B	X	A
Hydrogen sulphide, wet, 20°C	C	A	X	A
Hydrogen sulfide, dry, 20°C	A	A	X	A
Chlorine solution 0.1 gr./l	A	A	A	A
Chlorine solution 0.1 - 1 gr./l	A	A	A	A
Chlorine solution 1-10 gr./l 40°C	B	B	-	-
Chlorine solution > 10 gr./l 40°C	C	C	-	-
Sugar solutions	A	A	A	A
Non-oxidizing salt solutions	A	A	A	A
Caustic soda	C	A	B	A
Terpentine	A	X	A	A
40°C trichlorethylene	X	X	A	A
Sulfur trioxide, dry gas	X	B	A	A
Toluene	C	X	A	A
Whiskey, wine	A	A	A	A
Xylene	X	X	A	A

SORT CODE

- A Excellent behavior
- B Good behavior
- C Regular behavior
- X Incompatible
- No data

APLICACIONES VÁLVULAS INDUSTRIALES

- VALVULAS INDUSTRIALES
- INSTALACIONES
- CARACTERISTICAS DE LAS INSTALACIONES
- APLICACIONES DE VALVULAS MT A LAS INSTALACIONES

	COMPONENTES						
	REF.	PRESIÓN	TEMPERATURA	CUERPO	EJE	CIERRE	OTROS
FILTRO	5110	16	-20 a 120 - 200	Fundición Epoxi	-	EPDM - PTFE - Grafito	Tamiz inoxidable
	5125	16	0 a 80	Fundición Epoxi	-	NBR	-
VALVULAS RETENCIÓN	5142	16	0 a 80	Fundición Epoxi	-	NBR	-
	5116	16	-20 A 120	Fundición Epoxi	Inoxidable	EPDM	-
	5119	16	- 10 A 150	Inoxidable	Inoxidable	FKM	-
	5118	40	-20 a 300	Inoxidable	Inoxidable	Inoxidable	-
	5143	16	-20 A 120	Fundición Epoxi	Inoxidable	EPDM - NBR	Latón
COMPUERTA	5113	16	-20 a 120	Fundición Epoxi	Inoxidable	EPDM - NBR	Latón
	5132	16	-20 A 180	Inoxidable	Inoxidable	Inoxidable	Inoxidable
	5128	16	-20 A 180	Inoxidable	Inoxidable	PTFE	Bola inoxidable
VALVULA DE BOLA	5117	16	-20 a 180	Acero al carbono	Inoxidable	PTFE	Bola inoxidable
	0910-0917	63	-20 A 180	Inoxidable	Inoxidable	PTFE	Bola inoxidable
	0911-0912	63	-20 a 180	Inoxidable	Inoxidable	PTFE - FKM	Bola inoxidable
	5130	40	-10 a 400	Acero aleado	Inoxidable	Metálico	-
VALVULA DE GLOBO	51302	16	-10 a 400	Acero aleado	Inoxidable	Metálico	-
	5131	16	-20 a 200	Fundición Epoxi	Inoxidable	Metálico	-
	5115	10 - 16	-20 a 120	Fundición Epoxi	Inoxidable	EPDM	DI Cromado
	5114	10 - 16	-20 a 120	Fundición Epoxi	Inoxidable	EPDM	Inoxidable
	51142	10 - 16	-20 a 80	Fundición Epoxi	Inoxidable	NBR	-
MARIPOSA	51143	10 - 16	-20 a 180°C	Fundición Epoxi	Inoxidable	PTFE	-
	5144	10 - 16	-20 a 80	Fundición Epoxi	Inoxidable	NBR	Inoxidable
	5140	10 - 16	-20 a 80	Fundición Epoxi	Inoxidable	EPDM	Rilsan
	5141	10 - 16	-20 a 120	Fundición Epoxi	Inoxidable	EPDM	Inoxidable
	5145	25 - 40	-30 a 200	Fundición Epoxi	Inoxidable	PTFE	Inoxidable
MANGUITOS ELÁSTICOS	5120	16	-20 a 80-120	Acero galvanizado	-	EPDM-NBR	-
	5121	16	-20 a 80-120	Galvanizado	-	EPDM-NBR	-

APPLICATIONS INDUSTRIAL VALVES

- INDUSTRIAL VALVES
- INSTALLATIONS
- CHARACTERISTICS OF THE FACILITIES
- APPLICATIONS OF MT VALVES TO THE FACILITIES

	COMPONENTS						
	REF.	PRESSURE	TEMPERATURE	BODY	STEM	CLOSING	OTHERS
FILTER	5110	16	-20 a 120 - 200	Epoxy Casting	-	EPDM - PTFE - Graphite	Stainless sieve
	5125	16	0 a 80	Epoxy Casting	-	NBR	-
CHECK VALVES	5142	16	0 a 80	Epoxy Casting	-	NBR	-
	5116	16	-20 A 120	Epoxy Casting	Stainless	EPDM	-
	5119	16	- 10 A 150	Stainless	Stainless	FKM	-
	5118	40	-20 a 300	Stainless	Stainless	Stainless	-
	5143	16	-20 A 120	Epoxy Casting	Stainless	EPDM - NBR	Brass
GATE	5113	16	-20 a 120	Epoxy Casting	Stainless	EPDM - NBR	Brass
	5132	16	-20 A 180	Stainless	Stainless	Stainless	Stainless
	5128	16	-20 A 180	Stainless	Stainless	PTFE	Stainless ball
BALL VALVE	5117	16	-20 a 180	Aloy steel	Stainless	PTFE	Stainless ball
	0910-0917	63	-20 A 180	Stainless	Stainless	PTFE	Stainless ball
	0911-0912	63	-20 a 180	Stainless	Stainless	PTFE - FKM	Stainless ball
	5130	40	-10 a 400	Aloy steel	Stainless	Metal	-
GLOBE VALVE	51302	16	-10 a 400	Aloy steel	Stainless	Metal	-
	5131	16	-20 a 200	Epoxy Casting	Stainless	Metal	-
	5115	10 - 16	-20 a 120	Epoxy Casting	Stainless	EPDM	DI Chromed
	5114	10 - 16	-20 a 120	Epoxy Casting	Stainless	EPDM	Stainless
	51142	10 - 16	-20 a 80	Epoxy Casting	Stainless	NBR	-
BUTTERFLY	51143	10 - 16	-20 a 180°C	Epoxy Casting	Stainless	PTFE	-
	5144	10 - 16	-20 a 80	Epoxy Casting	Stainless	NBR	Stainless
	5140	10 - 16	-20 a 80	Epoxy Casting	Stainless	EPDM	Rilsan
	5141	10 - 16	-20 a 120	Epoxy Casting	Stainless	EPDM	Stainless
	5145	25 - 40	-30 a 200	Epoxy Casting	Stainless	PTFE	Stainless
RUBBER EXPANSION JOIN	5120	16	-20 a 80-120	Galvanized steel	-	EPDM-NBR	-
	5121	16	-20 a 80-120	Galvanized	-	EPDM-NBR	-

TIPO INSTALACIONES	Fluido	Temperatura	Presión
1	Aire comprimido	Aire (78%N - 21%O2 - 1% Otros)	Ambiente 8 - 10 bar
2	Contraincendios (bics o rociadores)	Agua	Ambiente 2 - 6 bar
3	Climatización calefacción	Agua o agua con glicol	4 hasta 90°C 1.5 - 5 bar
4	Energía Solar térmica (Primario)	Agua con glicol	-15 hasta 180°C 1.5 - 3 bar
5	Riego	Agua (con arena, cal etc.)	Ambiente 2 - 6 bar
6	Suministro agua para edificios	Agua mas o menos limpia	4 hasta 70°C 2 - 10 bar
7	Alimentación	Chocolate, mantequilla, mermelada, yogurt etc.	-20 hasta 90°C 1 - 20 bar
8	Vapor	Agua en estado vapor	140 hasta 250 10 - 35bar
9	Depuradoras	Agua sucia (puede contener hidrocarburos)	Ambiente 2 - 20 bar
10	Aguas fecales	Agua sucia (puede contener hidrocarburos)	10 hasta 60°C 1 - 4 bar
11	Químicos en general	Químicos	- -
12	Sólidos a granel	Pellets, comida para animales	Ambiente 1
13	Vacio	Ausencia de fluido (aire)	Ambiente <1
14	Centrales de producción energética	Varios	Variada
15	Piscinas	Agua y concentraciones elevadas de cloro o sales	15 hasta 30 1 - 1.5
16	Gases inertes	Argón, CO2, nitrógeno	- -
17	Gases comburentes	Oxígeno hidrógeno	- -
18	Gases combustibles	Gas natural (metano) - GLP (propano - butano)	- -
19	Instalaciones navales	Agua concentraciones elevadas de sal	Ambiente 2-10bar

ATENCIÓN: Este documento es solo una orientación de las aplicaciones de las válvulas industriales marca MT. Toda aplicación de una válvula deberá ser consultada con un ingeniero conocedor de la instalación que determine, el tipo de válvula mas adecuada, la compatibilidad de sus componentes con los fluidos a controlar y las condiciones de uso y ambientales. En ningún caso es un documento vinculante.

TYPE FACILITIES	Fluid	Temperature	Pressure
1	Compressed air	Air (78%N - 21%O2 - 1% Otros)	Environment 8 - 10 bar
2	Firefighting (Bics or Sprinklers)	Water	Environment 2 - 6 bar
3	Air conditioning Heating	Water or Water with glycol	4 to 90°C 1.5 - 5 bar
4	Thermal Solar Energy (Primary)	Water with glycol	-15 to 180°C 1.5 - 3 bar
5	Irrigation	Water (with sand, lime etc.)	Environment 2 - 6 bar
6	Water supplyfor buildings	More or less clean water	4 to 70°C 2 - 10 bar
7	Feeding	Chocolate, butter, jam, yogurt etc.	-20 a 90°C 1 - 20 bar
8	Steam	Steam water	140 to 250 10 - 35bar
9	Sewage treatment plants	Dirty water (may contain hydrocarbons)	Environment 2 - 20 bar
10	Sewage	Dirty water (may contain hydrocarbons)	10 to 60°C 1 - 4 bar
11	General chemicals	Chemicals	- -
12	Bulk solids	Pellets, animal food	Environment 1
13	Empty	Absence of fluid (air)	Environment <1
14	Power plants	Various	Varied
15	Swimming pools	Water and high concentrations of chlorine or salts	15 to 30 1 - 1.5
16	Inert gases	Argon, CO2, nitrogen	- -
17	Oxidizing gases	Hydrogen oxygen	- -
18	Combustible gases	Natural gas (methane) - LPG (propane - butane)	- -
19	Naval Facilities	Water high salt concentrations	Environment 2-10bar

ATTENTION: This document is only an orientation of the applications of the MT brand industrial valves. Any application of a valve must be consulted with an engineer who knows the installation that determines the most appropriate type of valve, the compatibility of its components with the fluids to be controlled and the conditions of use and environmental conditions. In no case is it a binding document.

TIPO INSTALACIONES FACILITIES TYPE	1	2	3	4	5	6	7	8	9	10	11	12	13	14	15	16	17	18	19	
FILTRO FILTER	5110	✓	✓	✓	√(*1)	✓	√(*2)	✗	√(*3)	✓	✓	-	✗	✗	√(*4)	✗	✗	✗	✗	✗
VALVULAS RETENCIÓN CHECK VALVE	5125	✗	✓	✗	✗	✓	✓	✗	✗	✓	✓	✗	√(*5)	✗	√(*4)	✗	✗	✗	✗	✗
	5142	✗	✓	✗	✗	✓	✓	✗	✗	✓	✓	✗	√(*5)	✗	√(*4)	✗	✗	✗	✗	✗
	5116	✓	✓	✓	✗	✗	✓	✗	✗	✗	✗	✗	✗	√(*4)	✗	✗	✗	✗	✗	✗
	5119	✓	✓	✓	✓	✗	✓	✓	✗	✗	✗	-	✓	✗	√(*4)	✗	✗	✗	✗	✗
	5118	✓	✓	✓	✓	✗	✓	✓	✗	✗	✗	-	✗	✗	√(*4)	✗	√(*9)	√(*9)	✗	✓
COMPUERTA GATE	5143	✗	✓	✗	✗	✓	✓	✗	✗	✓	√(*8)	-	✗	✗	√(*4)	✗	✗	✗	✗	✗
	5113	✗	✓	✗	✗	✓	✓	✗	✗	✓	√(*8)	-	✗	✗	√(*4)	✗	✗	✗	✗	✗
	5132	✗	✓	✓	✓	✗	✓	✓	✗	✓	✓	-	✓	✗	√(*4)	✗	√(*9)	√(*9)	✗	✓
VALVULA DE BOLA BALL VALVE	5128	✓	✓	✓	✓	✗	✓	✓	✗	✓	✓	-	✗	✗	√(*4)	✗	√(*9)	√(*9)	✗	✓
	5117	✓	✓	✓	✓	✗	✗	✗	✗	✓	✓	-	✗	✗	√(*4)	✗	✗	✗	✗	✗
	0910-0917	✓	✓	✓	✓	✓	✓	-	✗	✓	✓	✓	✗	✗	✓	✗	√(*9)	√(*9)	✗	✓
	0911-0912	✓	✓	✓	✓	✓	✓	-	✓	✓	✓	SO	✗	✗	✓	✗	√(*9)	√(*9)	✗	✓
VALVULA DE GLOBO GLOBE VALVE	5130	✗	✗	✗	✗	✗	✗	✗	✓	✗	✗	-	✗	✗	√(*4)	✗	✗	✗	✗	✗
	51302	✗	✗	✗	✗	✗	✗	✗	✓	✗	✗	-	✗	✗	√(*4)	✗	✗	✗	✗	✗
	5131	✗	✗	✗	✗	✗	✗	✓	✗	✗	-	✗	✗	✓	√(*4)	✗	✗	✗	✗	✗
	5115	✗	✓	✗	✗	✓	✗	✗	✗	✗	-	✗	✗	✓	√(*4)	✗	✗	✗	✗	✗
	5114	✗	✓	✓	✗	✓	✓	✗	✗	✓	√(*7)	√(*7)	-	✓	✗	√(*4)	✗	✗	✗	✗
MARIPOSA BUTTERFLY	51142	✗	✓	✓	✗	✓	✓	✗	✗	✓	✓	-	✓	✗	√(*4)	✗	✗	✗	✗	✗
	51143	✗	✗	✗	✗	✗	✗	✗	✓	✗	✓	✓	-	✗	✗	√(*4)	✓	✗	✗	✗
	5144	✗	✓	✓	✗	✓	✓	✗	✗	✓	✓	✓	-	✓	✗	√(*4)	✗	✗	✗	✗
	5140	✗	✗	✗	✗	✗	✗	✗	✓	✓	✓	✓	-	✗	✗	√(*4)	✓	✗	✗	✗
	5141	✗	✓	✓	✗	✓	✓	✗	✗	✓	✓	✓	-	✓	✗	√(*4)	✗	✗	✗	✗
	5145	✗	✗	✓	✓	✗	✗	✗	✗	✗	✗	-	✗	✗	√(*4)	✗	✗	✗	✗	✗
MANGUITOS ELÁSTICOS RUBBER EXPANSION JOIN	5120	√(*6)	✓	✓	✗	✓	✓	✗	✗	√(*7)	√(*7)	-	✓	✗	√(*4)	✗	✗	✗	✗	✗
	5121	√(*6)	✓	✓	✗	✓	✓	✗	✗	√(*7)	√(*7)	-	✓	✗	√(*4)	✗	✗	✗	✗	✗

POSIBLES PROBLEMAS POR ENTORNO

Corrientes inducidas.

Condiciones ambientales.

Desengrase de las válvulas.

Se pueden desengrasar bajo precio.

- Se debe cambiar la junta por una de Grafito.
- Depende de la exigencia de filtrado no cumple.
- Se debe cambiar la junta por una de Grafito y no superar los 200°C.
- Depende de la aplicación concreta. Libres de silicona. Se pueden desengrasar bajo precio.
- Si con reservas del tipo de sólido.
- Sólo la versión de NBR.
- Versión NBR por si contienen aceites o hidrocarburos.
- En caso de aceites e hidrocarburos su aplicación no es aconsejable.
- Se deben de limpiar y desengrasar específicamente. Cuidado con la junta.

POSSIBLE PROBLEMS BY ENVIRONMENT

Induced currents.

Environmental conditions.

Degreasing the valves.

You can degrease low price.

- The board must be replaced with a Graphite one.
- Depends on filtering requirement does not meet.
- The joint must be replaced with a Graphite one and not exceed 200°C.
- Depends on the specific application. Silicone-free. Can be degreased at a low price.
- If with solid type reservations.
- Only the NBR version.
- NBR version if they contain oils or hydrocarbons.
- In the case of oils and hydrocarbons, it's application is not advisable.
- Must be cleaned and degreased specifically, Take care with the seal.

COEFICIENTE DE CAUDAL KV

Kv es el coeficiente de caudal en unidades métricas. Se define como el caudal en metros cúbicos por hora [m³/h] de agua a una temperatura de 16° celsius con una caída de presión a través de la válvula de 1 bar.

Cv es el coeficiente de caudal en unidades imperiales. Se define como el caudal en galones US por minuto [gpm] de agua a la temperatura de 60° fahrenheit con una caída de presión a través de la válvula de 1 psi.

Cuando el flujo pasa a través de una válvula o otro dispositivo restrictivo pierde una energía. El **coeficiente de caudal** es un factor de diseño que relaciona la diferencia de altura (Δh) o presión (ΔP) entre la entrada y salida de la válvula con el caudal (Q). Este coeficiente permite calcular la pérdida de presión (ΔP) en la válvula para el caudal de trabajo.

Cada válvula tiene su propio coeficiente de caudal. Éste depende de como la válvula ha sido diseñada para dejar pasar el flujo a través de ella. Por consiguiente, las mayores diferencias entre diferentes coeficientes de caudal provienen del tipo de válvula, y naturalmente de la posición de abertura de la válvula.

Puede ser importante conocer el coeficiente de caudal para poder seleccionar la válvula que se necesita en una específica aplicación. Si la válvula va a estar la mayor parte del tiempo abierta, posiblemente interesará elegir una válvula con poca pérdida de carga para poder ahorrar energía. O si se trata de una válvula de control, el rango de coeficientes de caudal en las diferentes posiciones de abertura tendrían de permitir cumplir las necesidades de regulación de la aplicación.

ESQUEMA

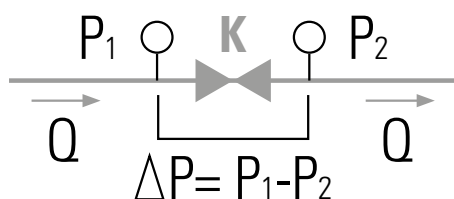

FÓRMULAS

Las fórmulas aquí referenciadas se pueden usar solo para líquidos con densidades y viscosidades cercanas a las del agua.

Equivalencia entre Kv y Cv:

$$Kv = 0.865 \cdot Cv$$

$$Cv = 1,156 \cdot Kv$$

Calculo de la pérdida de presión con caudal conocido:

$$\Delta P = \left[\frac{Q}{K} \right]^2 \cdot SG$$

Calculo del caudal con la pérdida de presión conocida:

$$Q = K \cdot \sqrt{\frac{\Delta P}{SG}}$$

Q: Caudal

ΔP : Diferencia de presión, pérdida de carga

SG: Gravedad específica (1 para agua)

K: Coeficiente de caudal Kv o Cv

SG: La gravedad específica es un numero adimensional, es decir no posee unidades. Es la relación entre la densidad de una sustancia y la densidad de otra tomada como referencia denominada sustancia patrón. Por convención, la sustancia patrón para sustancias líquidas y solidas es el agua (1), y para gases o vapores es el aire, cuya densidad en condiciones normales es 1,29 g / L.

KV FLOW COEFFICIENT

Kv is the flow coefficient in metric units. It is defined as the flow rate in cubic meters per hour [m³ / h] of water at a temperature of 16 ° Celsius with 1 bar pressure drop through the valve.

Cv is the flow coefficient in Imperial units. It is defined as the flow rate in US gallons per minute [gpm] of water at a temperature of 60 ° Fahrenheit with 1 PSI pressure drop through the valve.

When the flow passes through a valve or other restrictive device, it loses energy. The **flow coefficient** is a design factor that relates the difference in height (Δh) or pressure (ΔP) between the valve inlet and outlet with the flow rate (Q). This coefficient allows to calculate the pressure loss (ΔP) in the valve for the working flow.

Each valve has its own flow rate. It depends on how the valve has been determined to let the flow through it. In general, the greatest differences between different flow coefficients come from the type of valve, and of course from the valve opening position.

It is important to know the flow rate to be able to select the valve needed in each specific application. If the valve is going to be in open position most of the time, it may be interesting to choose a valve with little pressure loss to save energy. If it is a control valve, the range of flow coefficients in the different overture positions should allow the application regulation needs to be met.

SCHEME

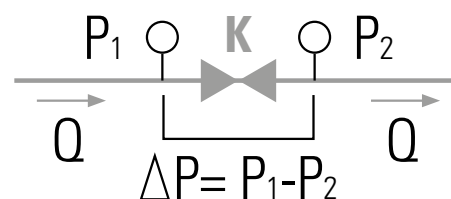

FORMULAS

The formulas here mentioned should be used only for liquids with densities and viscosities specific to those of water.

Equivalence between Kv and Cv:

$$Kv = 0.865 Cv$$

$$Cv = 1,156 Kv$$

Calculation of pressure loss with known flow:

$$\Delta P = \left[\frac{Q}{K} \right]^2 \cdot SG$$

Flow calculation with known pressure loss:

$$Q = K \cdot \sqrt{\frac{\Delta P}{SG}}$$

Q: Flow

ΔP : Pressure difference, pressure drop

SG: Specific Gravity (1 for water)

K: Flow coefficient Kv or Cv

SG: The specific gravity is a dimensionless number, that is, it has no units. It is the relationship between the density of one substance and the density of another taken as a patron. By convention, the standard substance for liquid and solid substances is water (1), and gases or steam is air, whose density under normal conditions is 1.29 g / L.

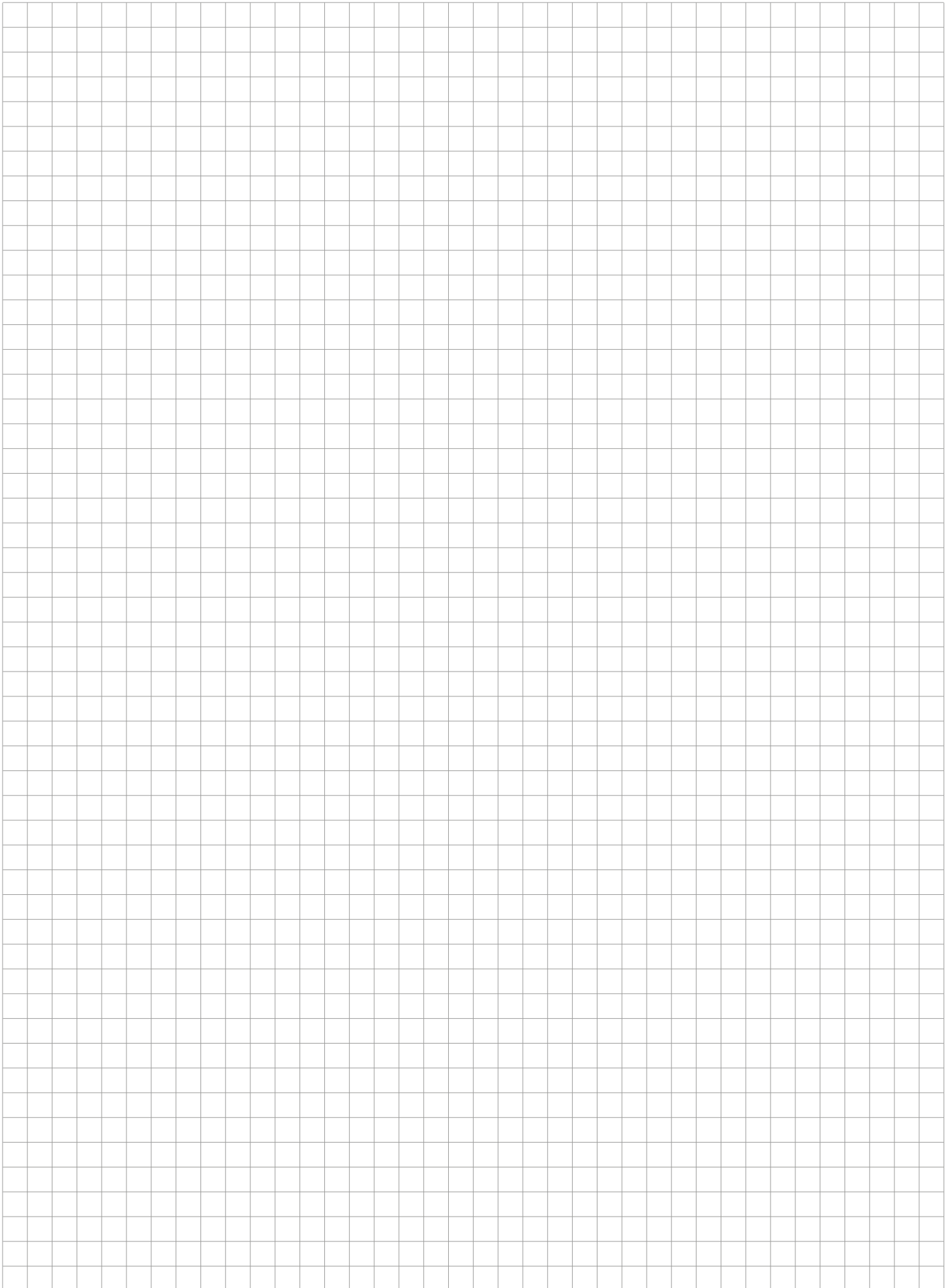

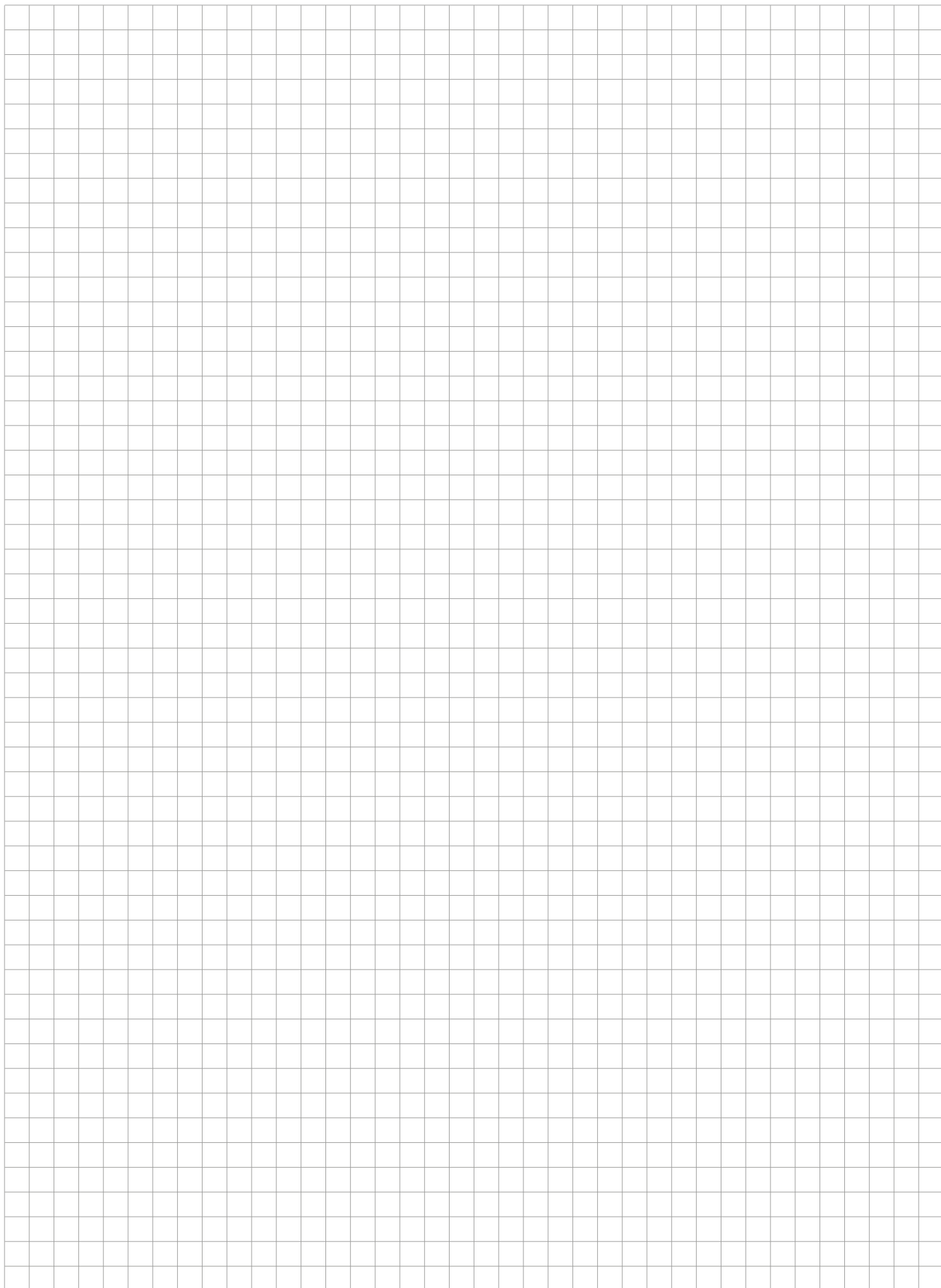



PACK DIGITAL DE DATOS DIGITAL DATA PACK



Descarga nuestro pack digital de datos para distribuidores, industriales y plataformas de venta online.

Download our digital data pack for distributors, industry and online sales platforms.



Pol. Sector Camps d'en Ricart
C/ Comerç, 10, naves 3 a 9
08780 Pallejà, Barcelona - SPAIN
Business Key, S.L.

Tel. +34 **936 804 980**
Fax. +34 936 804 981
info@mtspain.net

mtspain.net