



**GREE**

ALTA TECNOLOGÍA  
EN CLIMATIZACIÓN



TARIFA 2022

# CALEFACCIÓN & CLIMATIZACIÓN



DOMÉSTICO



AEROTERMIA



COMERCIAL



INDUSTRIAL

**Comprometidos con el medio ambiente.**  
Compensamos el 100% de nuestras  
emisiones de CO2 con plantaciones  
de árboles en zonas deforestadas.



GREE ELECTRIC APPLIANCES INC. OF ZHUHAI FUNDADA EN 1991, ES LA MAYOR EMPRESA DE AIRE ACONDICIONADO DEL MUNDO QUE INTEGRA TODO EL CICLO DE VIDA DEL PRODUCTO: **I+D, FABRICACIÓN, COMERCIALIZACIÓN Y SERVICIO.**

## LOS GRANDES NÚMEROS



**1** de cada **3**

máquinas en el mundo son fabricadas por **GREE**

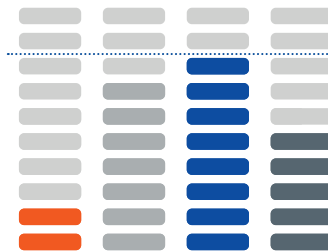

**65**  
millones  
de equipos

domésticos y comerciales  
y 5,5 millones de industriales  
y centralizados.

Los equipos de Gree se distribuyen en más de

**160**  
países y regiones



Más de **90.000**  
empleados  
a nivel mundial.



Cuenta con más de  
**100**  
partners  
en todo el mundo.



**400**  
millones de  
usuarios  
en todo el mundo.

DESDE SU CREACIÓN GREE SE HA SITUADO EN LA  
**VANGUARDIA TECNOLÓGICA.**

## TECNOLOGÍA E INNOVACIÓN



Más de **15.000**  
**INGENIEROS**

**6** departamentos  
**INSTITUCIONALES**



Más de **1.045**  
**LABORATORIOS**  
de ensayo de productos.



**LABORATORIOS**  
**NACIONALES**  
**DE I+D**

Más del **5%**  
de la **FACTURACIÓN**  
anual se **INVIERTE**  
**EN I+D**, aprox. 1.000  
millones de euros.

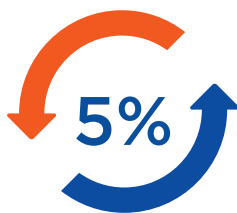

**126**  
**CENTROS DE I+D**



**GREE PRODUCE**  
todos sus  
**COMPONENTES**  
**CLAVES**

para garantizar la mayor  
calidad de sus productos.



**86.280**  
**PATENTES**  
**TECNOLÓGICAS**  
de las cuales  
**44.272**  
son de invención.



# GREE EN EL MUNDO



La presencia de Gree en el mercado mundial avanza cada año y su climatizador de uso residencial es el nº 1 desde 2005. Hasta el momento, los servicios internacionales de Gree han cubierto 30 000 grandes proyectos, incluido el Mundial de Fútbol de Sudáfrica, la

Banco Nacional de Bulgaria - BU



Expo Universal Milán 2015 - IT



CONAD Superstore - IT



Universidad Tecnológica de Panamá - PA



JJOO Río de Janeiro 2016 - BR1



Centro Médico Armonia - GR



1. Gree recibió oficialmente el reconocimiento como «Proveedor Oficial» de los Juegos Olímpicos de Río de 2016, tras haber logrado varios proyectos de climatización de centros de competición y de instalaciones anexas (pruebas olímpicas, villas olímpicas y hoteles colaboradores). Es la única empresa china que participa en los Juegos Olímpicos con marcas independientes 100 % Gree. Presente desde 2001 en Brasil, Gree es conocida por la conservación de la energía y del medioambiente.

villa olímpica de los medios de comunicación de Beijing, grandes centros de negocios en 2014, los Juegos Olímpicos de invierno Sochi, el Gran Salón del Pueblo, China Zun (el rascacielos más alto de Pekín), un reactor nuclear de agua a presión, el Mausoleo de Mao Zedong y el puente Hong Kong-Zhuhai-Macao, etc.

JJOO Sochi 2014 - RU



Aeronáutica - RU



Aeropuerto de Pekín-Daxing 2019 - CN 2



Centro Comercial Cubic - LB



Complejo residencial Norwood - AU



Copa del Mundo Sudáfrica - ZA



2. GREE Electric es el único proveedor del aeropuerto más grande del mundo, el aeropuerto internacional Pekín-Daxing. Según las previsiones, se invertirán en el proyecto 79 980 millones de yuanes y se construirán 7 pistas de aterrizaje para responder a la demanda anual de 100 millones de viajeros. Las unidades adoptan la tecnología High-Speed Permanent-Magnet Synchronous Direct-Driven Motor con Two-Stage Impeller Inverter Drive, que permite un enfriamiento más rápido y más eficaz, y un efecto de conservación de la energía un 40 % superior a un enfriamiento centrífugo normal.

# GREE EN ESPAÑA



## 2016

### CREACIÓN DE GREE PRODUCTS SL

La comercialización y los servicios de los productos de Gree Electric Appliances Inc. Of Zhuhai corren a cargo de Gree Products, importador exclusivo de la marca en España, Francia, Portugal y Suiza. Su objetivo es situar a Gree como la marca de referencia en tecnología, innovación y eficiencia energética en Europa.

GREE PRODUCTS, SL  
Carrer de Viriat, 47, Planta 7ª  
08014 Barcelona

☎ 932.687.586

✉ [comercial@greeproducts.es](mailto:comercial@greeproducts.es)

✉ [oficinatecnica@greeproducts.es](mailto:oficinatecnica@greeproducts.es)

(para estudio de proyectos VRF y chillers)

STOCK ESPAÑA  
Polígono Industrial Les Arenelles,  
Carrer de les Planes, 17  
43814 Vila-rodona, Tarragona



Convencidos de la calidad de los productos, Gree Products ofrece una garantía de 4 años en piezas y compresores, en todas sus gamas de productos\*.

Además, todos los productos tienen 3 años de garantía mano de obra incluidos.

\*Sólo los portátiles y deshumidificadores tienen una garantía de 3 años.



Nuestro soporte técnico, con sede en España y compuesto por técnicos expertos que intervienen periódicamente in situ, está a tu disposición para responder a todas tus problemáticas.

- **Gestión de las averías durante el periodo de garantía** con el apoyo de nuestra red de Estaciones Técnicas Autorizadas

- **Envío de piezas de repuesto** en garantía / fuera de garantía

- **Atención a llamadas técnicas en caso de avería** (código de error, asistencia en el montaje, diagnóstico de avería, arreglo y resolución de avería)

- Atención a llamadas técnicas

**para la instalación, gestión de los documentos técnicos** (ayuda a la instalación, instrucciones de montaje, vista en despiece, guía de soluciones...)

- **Organización de las puestas en marcha** según una tarificación única

- **Acompañamiento personalizado por un técnico referente** para la puesta en marcha (Gama Industrial)



☎ 931 820 238

✉ [asistenciatecnica@greeproducts.es](mailto:asistenciatecnica@greeproducts.es)

# SMART LIFE

LA LIBERTAD DE CONTROLAR TU CONFORT



DESCÁRGATE LA APLICACIÓN GREE+ Y CONTROLA TU AIRE ESTÉS DÓNDE ESTÉS.

A través de la aplicación podrás configurar la función *Smart Swing*, el Modo Pausa, el nivel sonoro de la máquina, establecer preferencias y mucho más.



“Ok Google, sube la temperatura del aire salón a 19°C”.

Para los sistemas operativos iOS y Android, la app GREE+ se puede descargar escaneando este código QR.







### SMART SWING

Configura la dirección de salida del aire del equipo de cualquier habitación.



### CONTROL DEL NIVEL SONORO

Controla el nivel sonoro del equipo seleccionando los valores deseados.



### TEMPORIZADOR SEMANAL

Elige una vez tus preferencias y tu unidad se encargará del resto.



### MODO AHORRO DE ENERGÍA

La unidad ajustará de forma automática la frecuencia y la potencia del ventilador y entrará en Modo Ahorro de energía cuando haya alcanzado el nivel de confort adecuado.



### MODO SLEEP PERSONALIZABLE

La temperatura y el nivel sonoro durante las horas de sueño se pueden controlar y personalizar de manera fácil e intuitiva.

**NOVEDAD**

**Ahora, ya puedes controlar tu unidad mural con Google Home y Alexa!**



Escanea un código para ver cómo configurarlo en tu móvil.

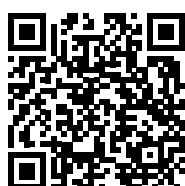

# RESPIRA UN AIRE SALUDABLE



Si bien a menudo hablamos de la contaminación del aire exterior en las ciudades, también es importante observar la **calidad del aire interior en los edificios**. De hecho, algunos estudios han demostrado que el aire de nuestros hogares está **entre dos y diez veces más contaminado que el aire del exterior**. Hoy en día, una cuarta parte de la población se ve afectada por estas enfermedades respiratorias, que a menudo están relacionadas con una mala ventilación en el hogar y esta cifra aumenta constantemente.

Para mejorar la calidad del aire en su hogar y mantener un ambiente limpio, es fundamental equiparse con un **sistema de aire acondicionado con los mejores filtros posibles**. Al actuar sobre ellos al actuar sobre las impurezas, contaminantes y olores, los filtros **capturan las partículas finas de polvo y limitan el desarrollo de bacterias y virus** para garantizar una mejor calidad del aire interior.



## GENERADOR DE IONES

El ionizador reproduce el sistema que ocurre en la naturaleza. Crea aniones (iones negativos) que, por efecto electrostático, actúan directamente sobre los cationes (iones positivos): partículas contaminantes cargadas positivamente en suspensión en el aire. El ionizador difunde entre 3 y 8 millones de aniones por segundo con un caudal de aire mínimo de 68 m<sup>2</sup>/h.



## CATEQUINA

El filtro de catequina impide la propagación de bacterias y la contaminación secundaria causada por la fauna microbiana (a diferencia de los filtros convencionales que absorben partículas en el aire pero no matan el virus). La catequina, extraída del té verde, es responsable de detener y atrapar partículas más grandes de polvo, pelo de animales, impurezas y malos olores.



## CARBÓN ACTIVO

El filtro de carbón permite en particular eliminar los fuertes olores a tabaco o los diversos vapores de la cocina. Atrapa moléculas en suspensión en el aire y, en particular, COV (compuestos orgánicos volátiles).



## PM2.5 + CATEQUINA

El filtro PM2.5 actúa contra la contaminación de los humos grises que se encuentran con frecuencia en los atascos densos y permite detener hasta un 40% de las partículas cuyo diámetro es el más preocupante para la salud. Agregado al filtro de catequina, brinda una protección real contra las bacterias y los malos olores.

Escanea este código y descubre cómo colocar y limpiar los filtros de polvo y filtros especiales.



	SOYAL	U-CROWN	FAIR	PULAR	MUSE
Generador de iones	-	De serie	De serie	-	-
Filtro de carbón activo	-	De serie	De serie	Opcional	Opcional
Filtro de catequina	-	Opcional	De serie	Opcional	Opcional
Filtro PM2.5 + Catequina	-	De serie	Opcional	Opcional	Opcional



ALTA TECNOLOGÍA  
EN CLIMATIZACIÓN

## U-CROWN

Tecnología y diseño único



### CONFORT OPTIMIZADO

- Wifi, Google Home y Alexa
- Nivel sonoro mínimo: 18 db(A)
- Difusión de aire 3D
- Filtros purificadores y ionizador

### DISEÑO HIGH-TECH ULTRA FINO

- Acabado en aluminio cepillado
- Solamente 17 cm de grosor



### TECNOLOGÍA PATENTADA: COMPRESOR DE DOBLE ETAPA

- Rendimiento mantenido a -15°C
- Operación garantizada en condiciones climáticas extremas:  
-18°C / +54°C en frío y -30°C / +24°C en calor



### MÁXIMO AHORRO ENERGÉTICO Y RESPETO POR EL MEDIO AMBIENTE

- Clase energética A+++  
y SEER de 7,5
- Gas ecológico R32



# INDICE



## 11 | DOMÉSTICO

- 12 | Deshumidificadores
- 12 | Portátiles
- 12 | Monosplits
- 15 | Multisplits Free Match

---

## 18 | AEROTERMIA

- 18 | Unidades exteriores GMV
- 19 | Bombas de calor Versati
- 21 | Depósitos de agua
- 21 | Bombas de calor ACS

---

## 24 | COMERCIAL

- 24 | Monosplits U-Match
- 27 | Columnas
- 27 | Ventanas
- 27 | Cortinas
- 27 | AC caravanas

---

## 28 | INDUSTRIAL

- 32 | Conductos de alta capacidad
- 33 | Unidades exteriores GMV
- 36 | Unidades interiores GMV
- 41 | Enfriadoras
- 42 | Fancoils

---







## 44 | ANEXOS









- 44 | Accesorios
- 48 | Combinaciones

# DOMÉSTICO

		CAPACIDAD DE DESHUMIFICACIÓN (L/día)						Pág.
		10	12		20			
<b>DESHUMIFICADORES</b>								
	AOVIA	<b>NUEVO</b> 3NGR0108		<b>NUEVO</b> 3NGR0109		<b>NUEVO</b> 3NGR0110	12	

		POTENCIA FRIGORÍFICA (kW)								Pág.		
		2.1	2.7	3.5	4.1	5	6.1	7	8.2	10	12	
<b>PORTÁTILES</b>												
	SHINY		3NGR0167	3NGR0168 3NGR0169								12

<b>MONOSPLITS</b>												
	U-CROWN		3NGR0270	3NGR0275		3NGR0280						12
	SOYAL		<b>NUEVO</b> 3NGR0530	<b>NUEVO</b> 3NGR0535		<b>NUEVO</b> 3NGR0540						13
	FAIR		<b>NUEVO</b> 3NGR0510	<b>NUEVO</b> 3NGR0515		<b>NUEVO</b> 3NGR0520		<b>NUEVO</b> 3NGR0525				14
	PULAR		<b>NUEVO</b> 3NGR0450	<b>NUEVO</b> 3NGR0455		<b>NUEVO</b> 3NGR0460		<b>NUEVO</b> 3NGR0465				14
	MUSE		<b>NUEVO</b> 3NGR0305	<b>NUEVO</b> 3NGR0310		<b>NUEVO</b> 3NGR0315		<b>NUEVO</b> 3NGR0320				14
	CONSOLA		3NGR0435	3NGR0440		3NGR0445						14

<b>MULTISPLITS FREE MATCH</b>												
	FREE MATCH				<b>NUEVO</b> 3NGR4525	<b>NUEVO</b> 3NGR4526	<b>NUEVO</b> 3NGR4527	<b>NUEVO</b> 3NGR4528	<b>NUEVO</b> 3NGR4529	<b>NUEVO</b> 3NGR4530	<b>NUEVO</b> 3NGR4531	15
	U-CROWN		3NGR4078	3NGR4079		3NGR4080						15
	FAIR		<b>NUEVO</b> 3NGR0511	<b>NUEVO</b> 3NGR0516		<b>NUEVO</b> 3NGR0521		<b>NUEVO</b> 3NGR0526				15
	PULAR		<b>NUEVO</b> 3NGR0406	<b>NUEVO</b> 3NGR0451	<b>NUEVO</b> 3NGR0456		<b>NUEVO</b> 3NGR0461		<b>NUEVO</b> 3NGR0466			16
	CONDUCTOS		<b>NUEVO</b> 3NGR4094	<b>NUEVO</b> 3NGR4095		<b>NUEVO</b> 3NGR4096		<b>NUEVO</b> 3NGR4097				16
	CASSETTE			<b>NUEVO</b> 3NGR4098K		<b>NUEVO</b> 3NGR4099K		<b>NUEVO</b> 3NGR4100K				16
	SUELO/TECHO		<b>NUEVO</b> 3NGR4104	<b>NUEVO</b> 3NGR4103		<b>NUEVO</b> 3NGR4102		<b>NUEVO</b> 3NGR4101				17
	CONSOLA		3NGR4081	3NGR4082		3NGR4083						17

Este documento no es una referencia para definir una configuración (consultar el catálogo y la documentación técnica).  
Reservados los derechos a modificar modelos y datos técnicos.  
PVR: Precio de venta recomendado sin IVA, no vinculante.

# DESHUMIDIFICADORES

NUEVO



## AOVIA DESHUMIDIFICADOR

R290

GARANTÍA  
3  
AÑOS  
PIEZAS



Desescarche inteligente. Deshumidificador. Aviso de cambio de filtro. Conector externo de drenaje. Indicador de humedad. Protección anti-desbordamiento. Indicador LED.

MODELO	CÓDIGO	DESHUM.	CLASE ENERG.	CABLE ALIM.	Ø GAS / LÍQUIDO	DIMENSIONES	PVR*
AOVIA 10	3NGR0108	10 L/d	-	-	-	352 / 398 / 206	296 €
AOVIA 12	3NGR0109	12 L/d	-	-	-	352 / 398 / 206	308 €
AOVIA 20	3NGR0110	20 L/d	-	-	-	352 / 490 / 240	514 €

# PORTÁTILES



## SHINY AIRE ACONDICIONADO PORTÁTIL

R290

GARANTÍA  
3  
AÑOS  
PIEZAS



Standby 0,5W. Modo automático. Modo sleep. Deshumidificador. Ventilador multi-velocidad. Conector externo de drenaje. Protección anti-desbordamiento. Temporizador 24h. Bloqueo de funciones. Indicador LED. Con kit ventana incluido.

MODELO	CÓDIGO	POTENCIA	CABLE ALIM.	Ø GAS / LÍQUIDO	DIMENSIONES	PVR*
SHINY 9	3NGR0167	2600 / - W	-	-	315 / 770 / 395	623 €
SHINY 12	3NGR0168	3520 / - W	-	-	390 / 820 / 405	833 €
SHINY 12FC	3NGR0169	3520 / 3300 W	-	-	390 / 820 / 405	888 €

# MONOSPLITS



## U-CROWN TECNOLOGÍA Y DISEÑO

R32

G<sup>10</sup> Inverter

WiFi

GARANTÍA  
4  
AÑOS  
PIEZAS



Control WiFi. Aire 3D. Swing horizontal. Swing vertical. Swing automatico. Standby 1W. Turbo cooling. Modo ahorro de energía. Modo fuera de casa. Modo automático. Modo sleep. 4 curvas en modo sleep. I Feel. Generador de iones. Filtros purificadores. Alta eficiencia. Auto clean X-Fan. Desescarche inteligente. Deshumidificador. Función pre-calefacción. Ventilador multi-velocidad. Control remoto led. Tecnología Inverter DC. Temporizador 24h. Panel retroiluminado. Modo silencioso. Bloqueo de funciones. Indicador LED. Encendido progresivo. Compatible mono & multi. Compresor de doble etapa. Protección Blue fin. Compatible con Alexa y Google home, Filtro de carbón activo, Filtro PM2.5 + Catequina.

MODELO	CÓDIGO	POTENCIA	CLASE ENERG.	CABLE ALIM. UE	Ø GAS / LÍQUIDO	DIMENSIONES UI	PVR*
U-CROWN 9	3NGR0270	2700 / 3200 W	A++/A+++	2 × 2,5 + T	3/8" - 1/4"	860 / 305 / 170	1.964 €
U-CROWN 12	3NGR0275	3530 / 4000 W	A++/A+++	2 × 2,5 + T	3/8" - 1/4"	860 / 305 / 170	2.018 €
U-CROWN 18	3NGR0280	5300 / 5300 W	A++/A+++	2 × 2,5 + T	1/2" - 1/4"	860 / 305 / 170	2.222 €

NUEVO



## SOYAL

TECNOLOGÍA Y CONFORT



Control WiFi. Aire 3D. Swing horizontal. Swing vertical. Swing automatico. Turbo cooling. Modo ahorro de energía. Modo fuera de casa. Modo automático. Modo sleep. 4 curvas en modo sleep. I Feel. Alta eficiencia. Auto clean X-Fan. Desescarche inteligente. Deshumidificador. Función pre-calefacción. Ventilador multi-velocidad. Control remoto led. Tecnología Inverter DC. Temporizador 24h. Panel retroiluminado. Modo silencioso. Bloqueo de funciones. Indicador LED. Encendido progresivo. Compatible mono & multi. Protección Blue fin. Compatible con Alexa y Google home.

MODELO	CÓDIGO	POTENCIA	CLASE ENERG.	CABLE ALIM. UE	Ø GAS / LÍQUIDO	DIMENSIONES UI	PVR*
SOYAL 9	3NGR0530	2700 / 3600 W	A+++ / A+++	2 x 2,5 + T	3/8" - 1/4"	977 / 281 / 295	2.471 €
SOYAL 12	3NGR0535	3530 / 4200 W	A+++ / A+++	2 x 2,5 + T	3/8" - 1/4"	977 / 281 / 295	2.553 €
SOYAL 18	3NGR0540	5300 / 5600 W	A++ / A++	2 x 2,5 + T	1/2" - 1/4"	977 / 281 / 295	2.956 €



## SOYAL

Diseño de vanguardia con altas prestaciones



### CONFORT OPTIMIZADO

- Wifi, Google Home y Alexa
- Nivel sonoro ultra-bajo: 18 db(A)
- Difusión de aire 3D

### DETECCIÓN CORPORAL POR INFRARROJOS

- Configuración del direccionamiento de aire en modo seguimiento o evasión
- Auto apagado sin presencia

### AMPLIO RANGO DE OPERACIÓN

Operación garantizada en condiciones climáticas extremas:  
-15°C / +48°C en frío y -25°C / +24°C en calor

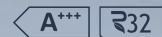

### MÁXIMO AHORRO ENERGÉTICO Y RESPETO POR EL MEDIO AMBIENTE

- Clase energética A+++ y SEER de 9,4
- Gas ecológico R32



NUEVO



## FAIR

CONFORT Y DISEÑO



Control WiFi. Swing vertical. Swing automatico. Standby 1W. Turbo cooling. Modo ahorro de energía. Modo fuera de casa. Modo automático. Modo sleep. 4 curvas en modo sleep. I Feel. Generador de iones. Filtros purificadores. Alta eficiencia. Auto clean X-Fan. Desescarche inteligente. Deshumidificador. Función pre-calefacción. Ventilador multi-velocidad. Control centralizado opcional. Control de pared opcional. Control paro/marcha opcional. Control remoto led. Tecnología Inverter DC. Temporizador 24h. Panel retroiluminado. Modo silencioso. Bloqueo de funciones. Indicador LED. Encendido progresivo. Compatible mono & multi. Protección Blue fin. Compatible con Alexa y Google home, Filtro de carbón activo.

MODELO	CÓDIGO	POTENCIA	CLASE ENERG.	CABLE ALIM. UE	Ø GAS / LÍQUIDO	DIMENSIONES UI	PVR*
FAIR 9	3NGR0510	2700 / 3000 W	A++ / A++	2 x 2,5 + T	3/8" - 1/4"	889 / 294 / 212	1.269 €
FAIR 12	3NGR0515	3510 / 3500 W	A++ / A++	2 x 2,5 + T	3/8" - 1/4"	889 / 294 / 212	1.342 €
FAIR 18	3NGR0520	5200 / 5200 W	A++ / A++	2 x 2,5 + T	1/2" - 1/4"	889 / 294 / 212	2.181 €
FAIR 24	3NGR0525	7100 / 7100 W	A++ / A++	2 x 2,5 + T	5/8" - 1/4"	889 / 294 / 212	2.710 €

NUEVO



## PULAR

CONFORT Y SIMPLICIDAD



Control WiFi. Swing vertical. Swing automatico. Turbo cooling. Modo ahorro de energía. Modo fuera de casa. Modo automático. Modo sleep. 4 curvas en modo sleep. I Feel. Auto clean X-Fan. Desescarche inteligente. Deshumidificador. Función pre-calefacción. Ventilador multi-velocidad. Control remoto led. Tecnología Inverter DC. Temporizador 24h. Panel retroiluminado. Bloqueo de funciones. Indicador LED. Encendido progresivo. Compatible mono & multi. Protección Blue fin. Compatible con Alexa y Google home, filtros de purificación opcionales.

MODELO	CÓDIGO	POTENCIA	CLASE ENERG.	CABLE ALIM. UE	Ø GAS / LÍQUIDO	DIMENSIONES UI	PVR*
PULAR 9	3NGR0450	2500 / 2800 W	A+/A++	3 x 2,5 + T	3/8" - 1/4"	732 / 550 / 330	831 €
PULAR 12	3NGR0455	3200 / 3400 W	A+/A++	3 x 2,5 + T	3/8" - 1/4"	732 / 550 / 330	884 €
PULAR 18	3NGR0460	4600 / 5200 W	A+/A++	3 x 2,5 + T	3/8" - 1/4"	732 / 550 / 330	1.570 €
PULAR 24	3NGR0465	6200 / 6500 W	A+/A++	3 x 2,5 + T	1/2" - 1/4"	732 / 550 / 330	2.104 €

NUEVO



## MUSE

ELEGANCIA Y SIMPLICIDAD



Control WiFi opcional. Swing vertical. Swing automatico. Turbo cooling. Modo ahorro de energía. Modo fuera de casa. Modo automático. Modo sleep. 4 curvas en modo sleep. I Feel. Auto clean X-Fan. Desescarche inteligente. Deshumidificador. Función pre-calefacción. Ventilador multi-velocidad. Control remoto led. Tecnología Inverter DC. Temporizador 24h. Panel retroiluminado. Bloqueo de funciones. Indicador LED. Encendido progresivo. Compatible mono & multi. Protección Blue fin. Compatible Google Home y Alexa, Filtros de purificación opcionales.

MODELO	CÓDIGO	POTENCIA	CLASE ENERG.	CABLE ALIM. UE	Ø GAS / LÍQUIDO	DIMENSIONES UI	PVR*
MUSE 9	3NGR0305	2500 / 2800 W	A++ / A+++	2 x 2,5 + T	3/8" - 1/4"	819 / 256 / 185	815 €
MUSE 12	3NGR0310	3200 / 3400 W	A++ / A+++	2 x 2,5 + T	3/8" - 1/4"	819 / 256 / 185	867 €
MUSE 18	3NGR0315	4600 / 5200 W	A++ / A+++	2 x 2,5 + T	3/8" - 1/4"	819 / 256 / 185	1.541 €
MUSE 24	3NGR0320	6155 / 6448 W	A++ / A+++	2 x 2,5 + T	5/8" - 1/4"	819 / 256 / 185	2.063 €



## CONSOLA

COMPACTO Y EFICIENTE



Control WiFi. Swing vertical. Swing automatico. Standby 1W. Turbo cooling. Modo fuera de casa. Modo automático. Modo sleep. Generador de iones. Auto clean X-Fan. Desescarche inteligente. Deshumidificador. Función pre-calefacción. Ventilador multi-velocidad. Control centralizado opcional. Control de pared opcional. Control remoto led. Diseño compacto. Tecnología Inverter DC. Temporizador 24h. Modo silencioso. Bloqueo de funciones. Indicador LED. Encendido progresivo. Compatible mono & multi. Protección Blue fin.

MODELO	CÓDIGO	POTENCIA	CLASE ENERG.	CABLE ALIM. UE	Ø GAS / LÍQUIDO	DIMENSIONES UI	PVR*
CONSOLA 9	3NGR0435	2700 / 2900 W	A++ / A+++	2 x 2,5 + T	3/8" - 1/4"	700 / 600 / 215	1.364 €
CONSOLA 12	3NGR0440	3520 / 3800 W	A++ / A+++	2 x 2,5 + T	3/8" - 1/4"	700 / 600 / 215	1.396 €
CONSOLA 18	3NGR0445	5200 / 5200 W	A++ / A+++	2 x 2,5 + T	1/2" - 1/4"	700 / 600 / 215	1.869 €



# MULTISPLITS FREE MATCH

NUEVO



## FREE MATCH

UNIDADES EXTERIORES HASTA 5X1



Modo automático. Desescarche inteligente. Amplio rango de tensión. Cobre con estriamiento interior. Control de pared opcional. Diseño compacto. Facilidad de mantenimiento. Tecnología Inverter DC. Bloqueo de funciones. Encendido progresivo. Protección Blue fin.

MODELO	CÓDIGO	POTENCIA	CABLE ALIM.	Ø GAS / LÍQUIDO	DIMENSIONES	PVR*
FM 14	3NGR4525	4100 / 4400 W	2 x 2,5 + T	2 x 3/8" - 2 x 1/4"	745 / 550 / 300	1.845 €
FM 18	3NGR4526	5300 / 5650 W	2 x 2,5 + T	2 x 3/8" - 2 x 1/4"	745 / 550 / 300	1.958 €
FM 21	3NGR4527	6100 / 6500 W	2 x 2,5 + T	3 x 3/8" - 3 x 1/4"	889 / 715 / 340	2.280 €
FM 24	3NGR4528	7100 / 8600 W	2 x 2,5 + T	3 x 3/8" - 3 x 1/4"	889 / 654 / 340	2.435 €
FM 28	3NGR4529	8000 / 9500 W	2 x 2,5 + T	4 x 3/8" - 4 x 1/4"	889 / 654 / 340	2.574 €
FM 36	3NGR4530	10600 / 12000 W	2 x 2,5 + T	4 x 3/8" - 4 x 1/4"	1020 / 826 / 427	4.027 €
FM 42	3NGR4531	12100 / 13000 W	2 x 2,5 + T	5 x 3/8" - 5 x 1/4"	1020 / 826 / 427	4.393 €

## U-CROWN

UNIDADES INTERIORES FREE MATCH



Control WiFi. Aire 3D. Swing automatico. Standby 1W. Turbo cooling. Modo ahorro de energía. Modo fuera de casa. Modo sleep. 4 curvas en modo sleep. I Feel. Generador de iones. Filtros purificadores. Alta eficiencia. Auto clean X-Fan. Desescarche inteligente. Función pre-calefacción. Control remoto led. Tecnología Inverter DC. Modo silencioso. Bloqueo de funciones. Indicador LED. Compatible mono & multi.

MODELO	CÓDIGO	POTENCIA	CLASE ENERG.	CABLE ALIM. + COM.	Ø GAS / LÍQUIDO	DIMENSIONES	PVR*
FM U-CROWN 9	3NGR4078	2600 / 3000 W	-	3 x 1,5 + 0,75	3/8" - 1/4"	860 / 305 / 170	798 €
FM U-CROWN 12	3NGR4079	3500 / 3600 W	-	3 x 1,5 + 0,75	3/8" - 1/4"	860 / 305 / 170	823 €
FM U-CROWN 18	3NGR4080	5275 / 5275 W	-	3 x 1,5 + 0,75	1/2" - 1/4"	960 / 320 / 205	843 €

NUEVO



## FAIR

UNIDADES INTERIORES FREE MATCH



Control WiFi. Swing automatico. Standby 1W. Turbo cooling. Modo ahorro de energía. Modo fuera de casa. Modo sleep. 4 curvas en modo sleep. I Feel. Filtros purificadores. Alta eficiencia. Auto clean X-Fan. Desescarche inteligente. Función pre-calefacción. Control centralizado opcional. Control de pared opcional. Control paro/marcha opcional. Control remoto led. Tecnología Inverter DC. Modo silencioso. Bloqueo de funciones. Indicador LED. Compatible mono & multi. Compatible con Alexa y Google home, Filtro de carbón activo.

MODELO	CÓDIGO	POTENCIA	CLASE ENERG.	CABLE ALIM. + COM.	Ø GAS / LÍQUIDO	DIMENSIONES	PVR*
FM FAIR 9	3NGR0511	2700 / 3000 W	-	3 x 1,5 + 0,75	3/8" - 1/4"	889 / 294 / 212	527 €
FM FAIR 12	3NGR0516	3510 / 3810 W	-	3 x 1,5 + 0,75	3/8" - 1/4"	889 / 294 / 212	546 €
FM FAIR 18	3NGR0521	5200 / 5300 W	-	3 x 1,5 + 0,75	1/2" - 1/4"	1013 / 307 / 221	847 €
FM FAIR 24	3NGR0526	7100 / 7800 W	-	3 x 1,5 + 0,75	5/8" - 1/4"	1122 / 329 / 247	1.020 €





## PULAR

### UNIDADES INTERIORES FREE MATCH



Control WiFi. Swing vertical. Turbo cooling. Modo ahorro de energía. Modo fuera de casa. Modo sleep. 4 curvas en modo sleep. I Feel. Auto clean X-Fan. Desescarche inteligente. Deshumidificador. Ventilador multi-velocidad. Control remoto led. Tecnología Inverter DC. Temporizador 24h. Panel retroiluminado. Indicador LED. Compatible mono & multi. Protección Blue fin. Compatible Google Home y Alexa, Filtros de purificación opcionales.

MODELO	CÓDIGO	POTENCIA	CLASE ENERG.	CABLE ALIM. + COM.	Ø GAS / LÍQUIDO	DIMENSIONES	PVR*
FM PULAR 7	3NGR0406	2200 / 2400 W	-	3 x 1,5 + 0,75	3/8" - 1/4"	704 / 260 / 185	306 €
FM PULAR 9	3NGR0451	2500 / 2800 W	-	3 x 1,5 + 0,75	3/8" - 1/4"	704 / 260 / 185	315 €
FM PULAR 12	3NGR0456	3200 / 3400 W	-	3 x 1,5 + 0,75	3/8" - 1/4"	779 / 260 / 185	331 €
FM PULAR 18	3NGR0461	4600 / 5200 W	-	3 x 1,5 + 0,75	1/2" - 1/4"	982 / 311 / 221	386 €
FM PULAR 24	3NGR0466	6200 / 6500 W	-	3 x 1,5 + 0,75	1/2" - 1/4"	982 / 311 / 221	725 €

KITS COMPLETOS	MODELO	CÓDIGO	PVR*
	FM 14 + FM PULAR 9 + FM PULAR 9	3NGR4536	2.475 €
	FM 21 + FM PULAR 9 + FM PULAR 12	3NGR4537	2.926 €
	FM 24 + FM PULAR 12 + FM PULAR 12	3NGR4538	3.097 €

NUEVO



## CONDUCTOS

### UNIDADES INTERIORES FREE MATCH



Control WiFi. Turbo cooling. Modo ahorro de energía. Modo sleep. I Feel. Alta eficiencia. Auto clean X-Fan. Desescarche inteligente. Deshumidificador. Función pre-calefacción. Ventilador multi-velocidad. Amplio rango de tensión. Bomba de drenaje incorporada. Cobre con estriamiento interior. Control centralizado opcional. Control de pared. Control remoto led. Diseño compacto. Protección anti-desbordamiento. Tecnología Inverter DC. Temporizador 24h. Bloqueo de funciones. Encendido progresivo.

MODELO	CÓDIGO	POTENCIA	CLASE ENERG.	CABLE ALIM. + COM.	Ø GAS / LÍQUIDO	DIMENSIONES	PVR*
FM CDT 9	3NGR4094	2650 / 2800 W	-	3 x 1,5 + 0,75	3/8" - 1/4"	700 / 200 / 615	883 €
FM CDT 12	3NGR4095	3500 / 4000 W	-	3 x 1,5 + 0,75	3/8" - 1/4"	710 / 200 / 450	925 €
FM CDT 18	3NGR4096	5000 / 5500 W	-	3 x 1,5 + 0,75	1/2" - 1/4"	900 / 200 / 615	983 €
FM CDT 24	3NGR4097	7000 / 8000 W	-	3 x 1,5 + 0,75	5/8" - 3/8"	900 / 260 / 655	1.118 €

NUEVO



## CASSETTE

### UNIDADES INTERIORES FREE MATCH



Control WiFi opcional. Aire 3D. Swing automatico. Turbo cooling. Modo ahorro de energía. Modo sleep. I Feel. Alta eficiencia. Auto clean X-Fan. Desescarche inteligente. Deshumidificador. Función pre-calefacción. Ventilador multi-velocidad. Amplio rango de tensión. Bomba de drenaje incorporada. Cobre con estriamiento interior. Control centralizado opcional. Control de pared opcional. Control remoto led. Diseño compacto. Protección anti-desbordamiento. Tecnología Inverter DC. Temporizador 24h. Bloqueo de funciones. Encendido progresivo.

MODELO	CÓDIGO	POTENCIA	CLASE ENERG.	CABLE ALIM. + COM.	Ø GAS / LÍQUIDO	DIMENSIONES	PVR*
FM CST 12	3NGR4098K	3500 / 4000 W	-	3 x 1,5 + 0,75	3/8" - 1/4"	570 / 265 / 570	899 €
FM CST 18	3NGR4099K	5000 / 5500 W	-	3 x 1,5 + 0,75	1/2" - 1/4"	570 / 265 / 596	913 €
FM CST 24	3NGR4100K	7000 / 8000 W	-	3 x 1,5 + 0,75	5/8" - 1/4"	840 / 240 / 840	1.126 €

NUEVO



## SUELO/TECHO

### UNIDADES INTERIORES FREE MATCH



Control WiFi opcional. Swing automatico. Turbo cooling. Modo ahorro de energía. Modo sleep. I Feel. Alta eficiencia. Auto clean X-Fan. Desescarche inteligente. Deshumidificador. Función pre-calefacción. Ventilador multi-velocidad. Amplio rango de tensión. Cobre con estriamiento interior. Control centralizado opcional. Control de pared opcional. Control remoto led. Temporizador 24h. Bloqueo de funciones. Encendido progresivo.

MODELO	CÓDIGO	POTENCIA	CLASE ENERG.	CABLE ALIM. + COM.	Ø GAS / LÍQUIDO	DIMENSIONES	PVR*
FM ST 9	3NGR4104	2600 / 2700 W	-	3 × 1,5 + 0,75	3/8" - 1/4"	870 / 665 / 235	894 €
FM ST 12	3NGR4103	3500 / 4000 W	-	3 × 1,5 + 0,75	1/2" - 1/4"	870 / 665 / 235	944 €
FM ST 18	3NGR4102	4500 / 5500 W	-	3 × 1,5 + 0,75	1/2" - 1/4"	870 / 665 / 235	959 €
FM ST 24	3NGR4101	7100 / 8000 W	-	3 × 1,5 + 0,75	5/8" - 3/8"	1200 / 665 / 235	1.165 €



## CONSOLA

### UNIDADES INTERIORES FREE MATCH



Control WiFi. Swing vertical. Swing automatico. Standby 1W. Turbo cooling. Modo fuera de casa. Modo automático. Modo sleep. Generador de iones. Auto clean X-Fan. Desescarche inteligente. Deshumidificador. Función pre-calefacción. Ventilador multi-velocidad. Control centralizado opcional. Control de pared opcional. Control remoto led. Tecnología Inverter DC. Temporizador 24h. Panel retroiluminado. Modo silencioso. Bloqueo de funciones. Indicador LED. Encendido progresivo. Compatible mono & multi.

MODELO	CÓDIGO	POTENCIA	CLASE ENERG.	CABLE ALIM. + COM.	Ø GAS / LÍQUIDO	DIMENSIONES	PVR*
FM CNS 9	3NGR4081	2700 / 2800 W	-	3 × 1,5 + 0,75	3/8" - 1/4"	700 / 600 / 215	651 €
FM CNS 12	3NGR4082	3500 / 3750 W	-	3 × 1,5 + 0,75	3/8" - 1/4"	700 / 600 / 215	673 €
FM CNS 18	3NGR4083	5200 / 5330 W	-	3 × 1,5 + 0,75	1/2" - 1/4"	700 / 600 / 215	708 €



# AEROTERMIA

	POTENCIA FRIGORÍFICA (kW)							Pág.	
	4	6	8	10	12	14	16	22.4	28

## UNIDADES EXTERIORES GMV

	GMV5 HOME					3IGR0019	3IGR0020	3IGR0021	3IGR0022	3IGR0023	18
--	-----------	--	--	--	--	----------	----------	----------	----------	----------	----

## BOMBAS DE CALOR VERSATI

	VERSATI III MONOBLOC	3IGR5104	3IGR5105	3IGR5106	3IGR5168 3IGR5172	3IGR5169 3IGR5173	3IGR5170 3IGR5174	3IGR5171 3IGR5175			19
--	----------------------	----------	----------	----------	----------------------	----------------------	----------------------	----------------------	--	--	----

	VERSATI III ALL-IN-ONE	3IGR5150	3IGR5155	<b>NUEVO</b> 3IGR5160 3IGR5350	<b>NUEVO</b> 3IGR5165 3IGR5355	<b>NUEVO</b> 3IGR5135 3IGR5360	<b>NUEVO</b> 3IGR5140 3IGR5365	<b>NUEVO</b> 3IGR5145 3IGR5370			20
--	------------------------	----------	----------	--------------------------------------	--------------------------------------	--------------------------------------	--------------------------------------	--------------------------------------	--	--	----

	VERSATI III SPLIT	3IGR5040	3IGR5045	<b>NUEVO</b> 3IGR5050 3IGR5075	<b>NUEVO</b> 3IGR5055 3IGR5080	<b>NUEVO</b> 3IGR5060 3IGR5085	<b>NUEVO</b> 3IGR5065 3IGR5090	<b>NUEVO</b> 3IGR5070 3IGR5095			20
--	-------------------	----------	----------	--------------------------------------	--------------------------------------	--------------------------------------	--------------------------------------	--------------------------------------	--	--	----

	CAPACIDAD (L)			Pág.
	185	190	300	

## DEPÓSITOS DE AGUA

	AQUAL							3IGR0081		21
--	-------	--	--	--	--	--	--	----------	--	----

	OCEAN							<b>NUEVO</b> 3IGR0092		21
---	-------	--	--	--	--	--	--	--------------------------	--	----

## BOMBAS DE CALOR ACS

	AEROS							3IGR5199		21
--	-------	--	--	--	--	--	--	----------	--	----

	MARINA	3IGR5210								21
--	--------	----------	--	--	--	--	--	--	--	----

## UNIDADES EXTERIORES GMV



### GMV5 HOME UNIDADES EXTERIORES GMV



Modo ahorro de energía. Alta eficiencia. Desescarche inteligente. Amplio rango de tensión. Cobre con estriamiento interior. Control centralizado opcional. Direccionamiento automático. Diseño compacto. Facilidad de mantenimiento. Golden fin. Grandes distancias frigoríficas. Supervisión remota opcional. Tecnología Inverter DC. Modo silencioso.

MODELO	CÓDIGO	POTENCIA	SEER / SCOP	CABLE ALIM.	Ø GAS / LÍQUIDO	DIMENSIONES	PVR*
GMV5 H 120	3IGR0019	12.1 / 12.1 kW	6.7 / 3.97	3 × 4 + T	5/8" - 3/8"	900 / 1345 / 340	5.391 €
GMV5 H 140	3IGR0020	14 / 14 kW	6.88 / 4.24	3 × 4 + T	5/8" - 3/8"	900 / 1345 / 340	5.553 €
GMV5 H 160	3IGR0021	16 / 16 kW	6.96 / 4.04	3 × 6 + T	3/4" - 3/8"	900 / 1345 / 340	5.807 €
GMV5 H 224	3IGR0022	22.4 / 22.4 kW	8.46 / 5.5	5 × 2,5+T	3/4" - 3/8"	1340 / 1605 / 765	10.291 €
GMV5 H 280	3IGR0023	28 / 28 kW	7.58 / 5.58	5 × 2,5+T	7/8" - 3/8"	1340 / 1605 / 765	10.915 €

## CALEFACCIÓN Y CLIMATIZACIÓN EN UN ÚNICO SISTEMA

MODELO	CÓDIGO	POTENCIA CALOR	SEER / SCOP	CABLE ALIM.	Ø GAS / LÍQUIDO	DIMENSIONES	PVR*
GMV5 HBOX 16G	3IGR0024	16 kW	-	3 × 6 + T	-	500 / 919 / 328	5.840 €

## ACS, CALEFACCIÓN Y RECUPERACIÓN DE CALOR EN UN ÚNICO SISTEMA

MODELO	CÓDIGO	POTENCIA CALOR	SEER / SCOP	CABLE ALIM.	Ø GAS / LÍQUIDO	DIMENSIONES	PVR*
GENERADOR ACS	3IGR0047	5.6 kW	-	3 × 2,5 + T	5/8" - 3/8"	462 / 462 / 1944	4.204 €

# BOMBAS DE CALOR VERSATI



## VERSATI III MONOBLOC

BOMBAS DE CALOR AIRE/AGUA



Control WiFi. Turbo cooling. Modo fuera de casa. Modo automático. Modo sleep. Alta eficiencia. Desescarche inteligente. Deshumidificador. Función pre-calefacción. Agua de salida 60°C. Amplio rango de tensión. Control de pared. Curva de calefacción para suelo radiante. Diseño compacto. Tecnología Inverter DC. Temporizador 24h. Temporizador semanal. Modo silencioso. Bloqueo de funciones. Indicador LED. Compresor de doble etapa. Protección Blue fin.

### MONOFÁSICO

MODELO	CÓDIGO	POTENCIA	SEER / SCOP	CABLE ALIM.	Ø GAS / LÍQUIDO	DIMENSIONES	PVR*
VERSATI III MB 4	3IGR5104	3 / 4.08 kW	4.83 / 4.7	3 x 1.5 +T	-	1150 / 756 / 390	5.372 €
VERSATI III MB 6	3IGR5105	4 / 6.1 kW	5.00 / 4.7	3 x 1.5 +T	-	1150 / 756 / 390	5.486 €
VERSATI III MB 8	3IGR5106	5 / 7.61 kW	5.05 / 4.65	3 x 1.5 +T	-	1150 / 756 / 390	5.595 €
VERSATI III MB 10	3IGR5168	7.8 / 10.2 kW	4.48 / 4.47	3 x 6 +T	-	1200 / 878 / 460	7.310 €
VERSATI III MB 12	3IGR5169	9.5 / 12.21 kW	4.48 / 4.45	3 x 6 +T	-	1200 / 878 / 460	8.190 €
VERSATI III MB 14	3IGR5170	12 / 14.2 kW	4.58 / 4.27	3 x 6 +T	-	1200 / 878 / 460	8.655 €
VERSATI III MB 16	3IGR5171	13 / 15.54 kW	4.55 / 4.17	3 x 6 +T	-	1200 / 878 / 460	8.994 €

### TRIFÁSICO

MODELO	CÓDIGO	POTENCIA	SEER / SCOP	CABLE ALIM.	Ø GAS / LÍQUIDO	DIMENSIONES	PVR*
VERSATI III MB 10 3F	3IGR5172	7.8 / 10.12 kW	4.53 / 4.47	5 x 1.5 +T	-	1200 / 878 / 460	7.349 €
VERSATI III MB 12 3F	3IGR5173	9.5 / 12.11 kW	4.58 / 4.45	5 x 1.5 +T	-	1200 / 878 / 460	8.775 €
VERSATI III MB 14 3F	3IGR5174	12 / 14.08 kW	4.58 / 4.27	5 x 1.5 +T	-	1200 / 878 / 460	9.001 €
VERSATI III MB 16 3F	3IGR5175	13 / 16 kW	4.55 / 4.17	5 x 1.5 +T	-	1200 / 878 / 460	9.092 €



## VERSATI III: MONOBLOC, SPLIT, ALL-IN-ONE

Bomba de calor aire/agua tecnológica y eficiente

**WiFi** **Modbus**  
**WIFI INTEGRADO**  
 • Control total de la unidad a distancia con la app GREE+  
 • Protocolo de comunicación Modbus integrado



**MÁXIMO AHORRO ENERGÉTICO**  
 • Clase energética A++  
 • Gas ecológico R32  
 • Certificada Eurovent y Keymark\*

**COMPONENTES DE ÚLTIMA TECNOLOGÍA**  
 • Bomba Inverter Wilo  
 • Intercambiador de placas Danfoss  
 • Alpha Laval PHE  
 • Compresor patentado GREE de doble etapa  
 • Motor ventilador DC Inverter

**SALIDA DE AGUA A 60°C**  
 Funcionamiento bajo temperaturas extremas hasta -25°C exteriores





## VERSATI III ALL-IN-ONE

BOMBAS DE CALOR AIRE/AGUA



Control WiFi. Turbo cooling. Modo fuera de casa. Modo automático. Modo sleep. Alta eficiencia. Desescarche inteligente. Deshumidificador. Función pre-calefacción. Agua de salida 60°C. Amplio rango de tensión. Control de pared. Curva de calefacción para suelo radiante. Diseño compacto. Tecnología Inverter DC. Temporizador 24h. Temporizador semanal. Modo silencioso. Bloqueo de funciones. Indicador LED. Compresor de doble etapa. Protección Blue Fin.

### MONOFÁSICO

MODELO	CÓDIGO	POTENCIA	SEER / SCOP	CABLE ALIM. UE	Ø GAS / LÍQUIDO	DIMENSIONES UI	PVR*
VERSATI III AIO 4	3IGR5150	3.4 / 3.9 kW	-	3 × 1.5 + T	1/2" - 1/4"	600 / 1800 / 650	8.608 €
VERSATI III AIO 6	3IGR5155	4 / 5.8 kW	-	3 × 1.5 + T	1/2" - 1/4"	600 / 1800 / 650	9.156 €
VERSATI III AIO 8	3IGR5160	7.15 / 8 kW	-	3 × 1.5 + T	1/2" - 1/4"	600 / 1800 / 650	9.814 €
VERSATI III AIO 10	3IGR5165	7.60 / 9.85 kW	-	3 × 1.5 + T	1/2" - 1/4"	600 / 1800 / 650	14.612 €
VERSATI III AIO 12	3IGR5135	10.59 / 12.40 kW	-	3 × 1.5 + T	5/8" - 1/4"	600 / 1800 / 650	17.208 €
VERSATI III AIO 14	3IGR5140	11.07 / 14.48 kW	-	3 × 1.5 + T	5/8" - 1/4"	600 / 1800 / 650	17.700 €
VERSATI III AIO 16	3IGR5145	11.51 / 16.09 kW	-	3 × 1.5 + T	5/8" - 1/4"	600 / 1800 / 650	17.993 €

### TRIFÁSICO

MODELO	CÓDIGO	POTENCIA	SEER / SCOP	CABLE ALIM. UE	Ø GAS / LÍQUIDO	DIMENSIONES UI	PVR*
VERSATI III AIO 8 3F	3IGR5350	7.60 / 8.00 kW	-	5 × 2.5 + T	1/2" - 1/4"	600 / 1800 / 650	11.615 €
VERSATI III AIO 10 3F	3IGR5355	8.20 / 10.20 kW	-	5 × 2.5 + T	1/2" - 1/4"	600 / 1800 / 650	14.712 €
VERSATI III AIO 12 3F	3IGR5360	10.65 / 12.29 kW	-	5 × 2.5 + T	5/8" - 1/4"	600 / 1800 / 650	17.208 €
VERSATI III AIO 14 3F	3IGR5365	11.24 / 14.44 kW	-	5 × 2.5 + T	5/8" - 1/4"	600 / 1800 / 650	18.210 €
VERSATI III AIO 16 3F	3IGR5370	11.52 / 16.13 kW	-	5 × 2.5 + T	5/8" - 1/4"	600 / 1800 / 650	18.950 €



## VERSATI III SPLIT

BOMBAS DE CALOR AIRE/AGUA



Control WiFi. Turbo cooling. Modo fuera de casa. Modo automático. Modo sleep. Alta eficiencia. Desescarche inteligente. Deshumidificador. Función pre-calefacción. Agua de salida 60°C. Amplio rango de tensión. Control de pared. Curva de calefacción para suelo radiante. Diseño compacto. Tecnología Inverter DC. Temporizador 24h. Temporizador semanal. Modo silencioso. Bloqueo de funciones. Indicador LED. Compresor de doble etapa. Protección Blue Fin.

### MONOFÁSICO

MODELO	CÓDIGO	POTENCIA	SEER / SCOP	CABLE ALIM. UE	Ø GAS / LÍQUIDO	DIMENSIONES UI	PVR*
VERSATI III SP 4	3IGR5040	3.15 / 4.00 kW	-	3 × 1.5 + T	1/2" - 1/4"	460 / 860 / 318	5.670 €
VERSATI III SP 6	3IGR5045	4.09 / 6.00 kW	-	3 × 1.5 + T	1/2" - 1/4"	460 / 860 / 318	5.873 €
VERSATI III SP 8	3IGR5050	5.30 / 8.00 kW	-	3 × 1.5 + T	1/2" - 1/4"	460 / 860 / 318	6.672 €
VERSATI III SP 10	3IGR5055	6.50 / 9.50 kW	-	3 × 1.5 + T	1/2" - 1/4"	460 / 860 / 318	7.266 €
VERSATI III SP 12	3IGR5060	10.59 / 12.40 kW	-	3 × 1.5 + T	5/8" - 1/4"	460 / 860 / 318	15.114 €
VERSATI III SP 14	3IGR5065	11.07 / 14.48 kW	-	3 × 1.5 + T	5/8" - 1/4"	460 / 860 / 318	15.550 €
VERSATI III SP 16	3IGR5070	11.51 / 16.09 kW	-	3 × 1.5 + T	5/8" - 1/4"	460 / 860 / 318	16.101 €

### TRIFÁSICO

MODELO	CÓDIGO	POTENCIA	SEER / SCOP	CABLE ALIM. UE	Ø GAS / LÍQUIDO	DIMENSIONES UI	PVR*
VERSATI III SP 8 3F	3IGR5075	7.60 / 8.00 kW	-	5 × 2.5 + T	1/2" - 1/4"	460 / 860 / 318	10.907 €
VERSATI III SP 10 3F	3IGR5080	8.20 / 10.20 kW	-	5 × 2.5 + T	1/2" - 1/4"	460 / 860 / 318	11.652 €
VERSATI III SP 12 3F	3IGR5085	10.65 / 12.29 kW	-	5 × 2.5 + T	5/8" - 1/4"	460 / 860 / 318	15.915 €
VERSATI III SP 14 3F	3IGR5090	11.24 / 14.44 kW	-	5 × 2.5 + T	5/8" - 1/4"	460 / 860 / 318	16.374 €
VERSATI III SP 16 3F	3IGR5095	11.52 / 16.13 kW	-	5 × 2.5 + T	5/8" - 1/4"	460 / 860 / 318	16.955 €

# DEPÓSITOS DE AGUA



## AQUAL DEPÓSITO DE AGUA

Agua de salida 55°C. Resistencia auxiliar. Tecnología Inverter DC.



MODELO	CÓDIGO	CAPACIDAD	POTENCIA CALOR	SCOP / COP	CABLE ALIM.	Ø GAS / LÍQUIDO	DIMENSIONES	PVR*
AQUAL 300	3IGR0081	300 L	-	-	3 × 1,5 + T	-	620 / 1725 / 620	3.546 €

NUEVO



## OCEAN DEPÓSITO DE AGUA

Agua de salida 55°C. Resistencia auxiliar. Tecnología Inverter DC.



MODELO	CÓDIGO	CAPACIDAD	POTENCIA CALOR	SCOP / COP	CABLE ALIM.	Ø GAS / LÍQUIDO	DIMENSIONES	PVR*
OCEAN 300	3IGR0092	300 L	-	-	3 × 1,5 + T	-	790 / 1585 / 620	4.444 €
OCEAN 300 3F	3IGR0093	300 L	-	-	5 × 1,5 + T	-	790 / 1585 / 620	4.505 €

# BOMBAS DE CALOR ACS



## AEROS BOMBA DE CALOR ACS MONOBLOC

Modo ahorro de energía. Alta eficiencia. Desescarche inteligente. Agua de salida 55°C. Resistencia auxiliar. Tecnología Inverter DC. Temporizador 24h. Panel retroiluminado. Bloqueo de funciones.



MODELO	CÓDIGO	CAPACIDAD	POTENCIA CALOR	SCOP / COP	CABLE ALIM.	Ø GAS / LÍQUIDO	DIMENSIONES	PVR*
AEROS MB 190	3IGR5199	190 L	1.5 kW	2.24 / 3.5	3 × 1,5 + T	-	621 / 2030 / 561	3.434 €



## MARINA BOMBA DE CALOR ACS SPLIT

Modo ahorro de energía. Alta eficiencia. Desescarche inteligente. Agua de salida 55°C. Resistencia auxiliar. Tecnología Inverter DC. Temporizador 24h. Panel retroiluminado. Bloqueo de funciones.



MODELO	CÓDIGO	CAPACIDAD	POTENCIA CALOR	SCOP / COP	CABLE ALIM.	Ø GAS / LÍQUIDO	DIMENSIONES UI	PVR*
MARINA SP 185	3IGR5210	185 L	3.5 kW	3.08 / 4.1	3 × 1,5 + T	3/8" - 1/4"	462 / 2000 / 462	3.789 €

# ESQUEMAS DE PRINCIPIO DE LAS INSTALACIONES VERSATI



Los siguientes esquemas se refieren a las instalaciones de los modelos Versati Monobloc y Split. Cuando instale un Versati All-in-One, consulte los esquemas sin ACS, ya que el ACS está integrado.

## SIN ACS

**1. 1 zona > Suelo radiante o refrescante**

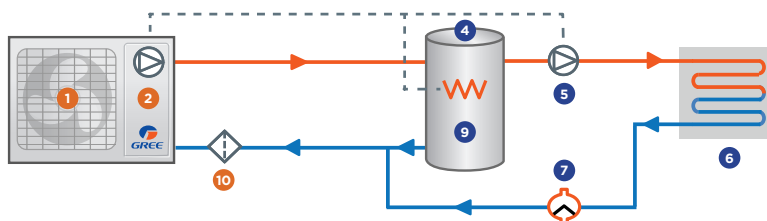

**2. 2 zonas > Suelo radiante o refrescante**

Con temperaturas de consigna diferentes

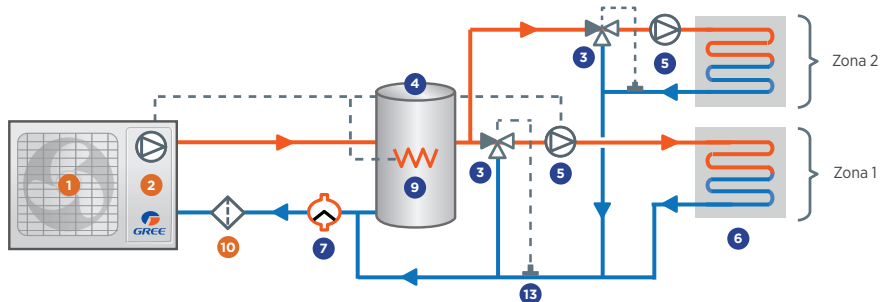

**3. 2 zonas > Suelo radiante y radiador calefacción\***

\*Opción refrigeración con el fancoil

Con temperaturas de consigna diferentes

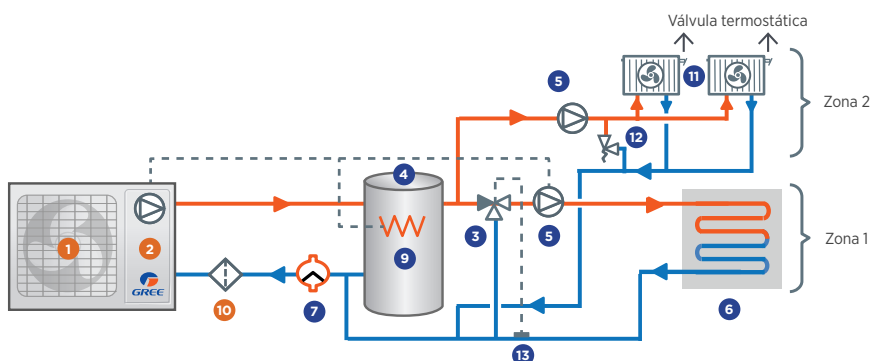

1 Bomba de calor  
2 Bomba de agua primaria

3 Válvula de 3 vías  
4 Depósito de inercia

5 Bomba de agua secundaria  
6 Suelo radiante baja temperatura

7 Purgador  
8 Depósito ACS 3IGR0081



La bomba de agua de la zona 2 se conecta sobre la corriente, la de la zona 1 a la bomba de calor.  
 Se recomienda encarecidamente el depósito de inercia, consulta a tu instalador para estudiar la necesidad en función de su instalación.

## CON ACS

**4. 1 zona > Suelo radiante o refrescante + ACS**

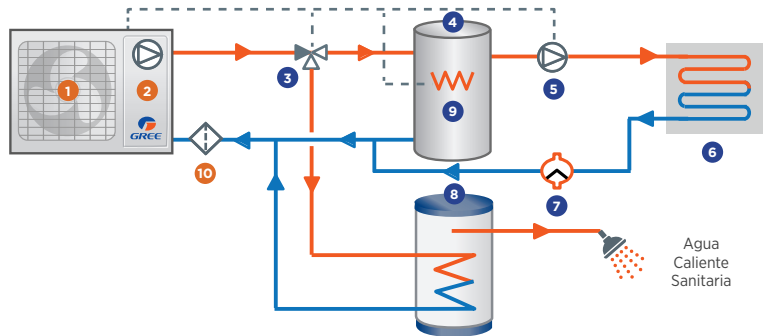

**5. 2 zonas > Suelo radiante o refrescante + ACS**

Con temperaturas de consigna diferentes

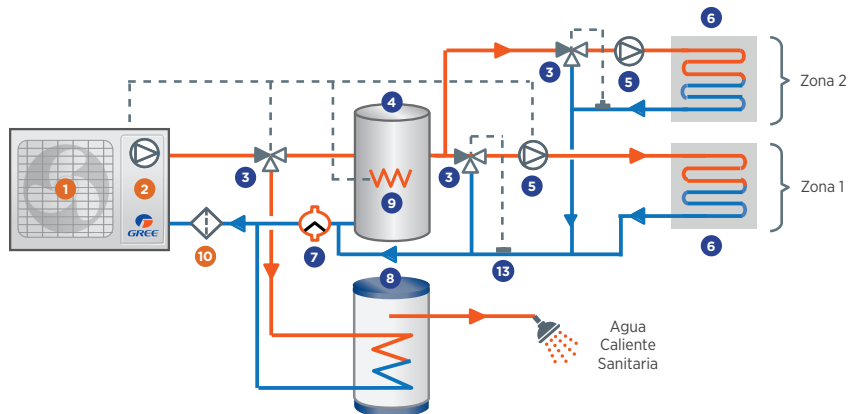

**6. 2 zonas > Suelo radiante y radiador calefacción\* + ACS**

\*Opción refrigeración con el fancoil

Con temperaturas de consigna diferentes

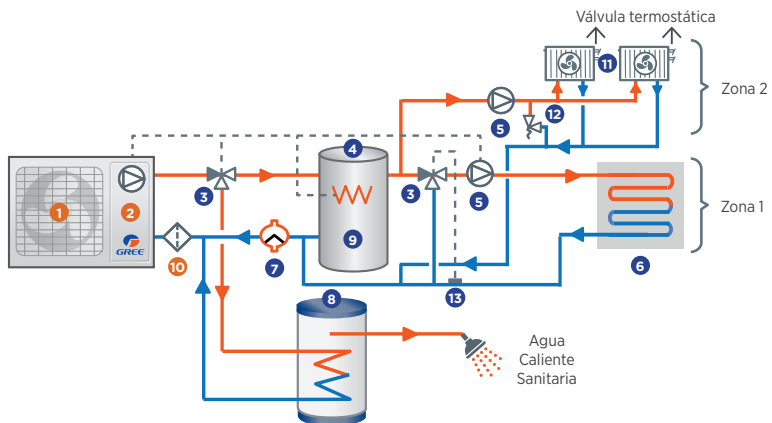







- 9 Resistencia eléctrica auxiliar
- 10 Filtro de agua

- 11 Fancoil o radiador
- 12 Válvula de BY-Pass

- 13 Sonda
- No incluido

# COMERCIAL

		POTENCIA FRIGORÍFICA (kW)								Pág.	
		2.7	3.5	5	7	8.2	10	12	13.4	16	
<b>MONOSPLITS U-MATCH</b>											
	DUCTOS		3NGR1125	3NGR1130	3NGR1180	3NGR1185	3NGR1145 3NGR1160	3NGR1150 3NGR1165	3NGR1155 3NGR1170	3NGR1175	24
	CASSETTE		3NGR2065	3NGR2070	3NGR2075	3NGR2080	3NGR2085 3NGR2100	3NGR2090 3NGR2105	3NGR2095 3NGR2110	3NGR2115	25
	SUELO/TECHO		3NGR3065	3NGR3070	3NGR3075	3NGR3080	3NGR3085 3NGR3100	3NGR3090 3NGR3105	3NGR3095 3NGR3110	3NGR3115	26
<b>COLUMNAS</b>											
	T-FRESH				3NGR0170			3NGR0175 3NGR0285			27
<b>VENTANAS</b>											
	COOLANI	3NGR0200	3NGR0201								27
<b>AC CARAVANAS</b>											
	GOCOOL	<b>NUEVO</b> 3NGR7015	<b>NUEVO</b> 3NGR7020								27

		1250		1650		Pág.
		SUPERFICIE TRATADA (m <sup>2</sup> /hora)				
<b>CORTINAS</b>						
	CORTINA DE AIRE		3NGR8000		3NGR8001	27

## MONOSPLITS U-MATCH

### CONDUCTOS UNIDADES U-MATCH



Control WiFi opcional. Standby 1W. Turbo cooling. Modo ahorro de energía. Modo fuera de casa. Modo automático. Modo sleep. Alta eficiencia. Auto clean X-Fan. Desescarche inteligente. Deshumidificador. Función pre-calefacción. Ventilador multi-velocidad. Alta presión estática. Aviso de limpieza de filtros. Bomba de drenaje incorporada. Control centralizado opcional. Control de pared. Control paro/marcha opcional. Control remoto led opcional. Diseño compacto. Protección anti-desbordamiento. Tecnología Inverter DC. Temporizador 24h. Temporizador semanal opcional. Bloqueo de funciones. Encendido progresivo. Compatible mono & multi opcional. Protección Blue fin.

### MONOFÁSICO

MODELO	CÓDIGO	POTENCIA	CLASE ENERG.	CABLE ALIM. UE	Ø GAS / LÍQUIDO	DIMENSIONES UI	PVR*
<b>UM CDT 12</b>	3NGR1125	3500 / 4000 W	A++ / A+	3 × 1,5	3/8" - 1/4"	700 / 200 / 450	<b>1.882 €</b>
<b>UM CDT 18</b>	3NGR1130	5000 / 5500 W	A++ / A+	3 × 1,5	1/2" - 1/4"	700 / 200 / 450	<b>2.181 €</b>
<b>UM CDT 24</b>	3NGR1180	7000 / 8000 W	A++ / A+	3 × 1,5	5/8" - 3/8"	700 / 200 / 450	<b>2.363 €</b>
<b>UM CDT 30</b>	3NGR1185	8500 / 8800 W	A++ / A+	3 × 1,5	5/8" - 3/8"	700 / 200 / 450	<b>2.895 €</b>
<b>UM CDT 36</b>	3NGR1145	10000 / 12000 W	A++ / A+	3 × 1,5	5/8" - 3/8"	700 / 200 / 450	<b>3.437 €</b>
<b>UM CDT 42</b>	3NGR1150	12100 / 13500 W	A+ / A	3 × 1,5	5/8" - 3/8"	700 / 200 / 450	<b>3.978 €</b>
<b>UM CDT 48</b>	3NGR1155	13400 / 15500 W	A++ / A	3 × 1,5	5/8" - 3/8"	700 / 200 / 450	<b>4.419 €</b>

## TRIFÁSICO

MODELO	CÓDIGO	POTENCIA	CLASE ENERG.	CABLE ALIM. UE	Ø GAS / LÍQUIDO	DIMENSIONES UI	PVR*
<b>UM CDT 36 3F</b>	3NGR1160	10000 / 12000 W	A++ / A+	5 × 2,5	5/8" - 3/8"	1000 / 300 / 700	<b>4.298 €</b>
<b>UM CDT 42 3F</b>	3NGR1165	12100 / 13500 W	A+ / A	5 × 2,5	5/8" - 3/8"	1000 / 300 / 700	<b>4.778 €</b>
<b>UM CDT 48 3F</b>	3NGR1170	13400 / 15500 W	A+ / A	5 × 2,5	5/8" - 3/8"	1000 / 300 / 700	<b>5.145 €</b>
<b>UM CDT 60 3F</b>	3NGR1175	16000 / 17000 W	A++ / A	5 × 2,5	5/8" - 3/8"	1000 / 300 / 700	<b>5.659 €</b>



## CASSETTE UNIDADES U-MATCH



Control WiFi opcional. Swing horizontal. Swing vertical. Swing automatico. Standby 1W. Turbo cooling. Modo ahorro de energía. Modo fuera de casa. Modo sleep. Alta eficiencia. Auto clean X-Fan. Desescarche inteligente. Deshumidificador. Función pre-calefacción. Ventilador multi-velocidad. Aviso de limpieza de filtros. Bomba de drenaje incorporada. Control centralizado opcional. Control de pared opcional. Control paro/marcha opcional. Control remoto led. Diseño compacto. Protección anti-desbordamiento. Tecnología Inverter DC. Temporizador 24h. Temporizador semanal opcional. Bloqueo de funciones. Encendido progresivo. Compatible mono & multi opcional. Protección Blue fin.

## MONOFÁSICO

MODELO	CÓDIGO	POTENCIA	CLASE ENERG.	CABLE ALIM. UE	Ø GAS / LÍQUIDO	DIMENSIONES UI	PVR*
<b>UM CST 12</b>	3NGR2065	3500 / 4000 W	A+ / A+	3 × 1,5	3/8" - 1/4"	570 / 265 / 570	<b>1.887 €</b>
<b>UM CST 18</b>	3NGR2070	5000 / 5500 W	A+ / A+	3 × 1,5	1/2" - 1/4"	570 / 265 / 570	<b>2.257 €</b>
<b>UM CST 24</b>	3NGR2075	7000 / 8000 W	A++ / A	3 × 1,5	5/8" - 3/8"	570 / 265 / 570	<b>2.434 €</b>
<b>UM CST 30</b>	3NGR2080	8500 / 8800 W	A++ / A+	3 × 1,5	5/8" - 3/8"	570 / 265 / 570	<b>2.997 €</b>
<b>UM CST 36</b>	3NGR2085	10000 / 12000 W	A++ / A+	3 × 1,5	5/8" - 3/8"	570 / 265 / 570	<b>3.588 €</b>
<b>UM CST 42</b>	3NGR2090	12100 / 13500 W	A+ / A	3 × 1,5	5/8" - 3/8"	570 / 265 / 570	<b>4.007 €</b>
<b>UM CST 48</b>	3NGR2095	13400 / 15500 W	A++ / A	3 × 1,5	5/8" - 3/8"	570 / 265 / 570	<b>4.503 €</b>

## TRIFÁSICO

MODELO	CÓDIGO	POTENCIA	CLASE ENERG.	CABLE ALIM. UE	Ø GAS / LÍQUIDO	DIMENSIONES UI	PVR*
<b>UM CST 36 3F</b>	3NGR2100	10000 / 12000 W	A++ / A+	5 × 2,5	5/8" - 3/8"	840 / 240 / 840	<b>4.449 €</b>
<b>UM CST 42 3F</b>	3NGR2105	12100 / 13500 W	A+ / A	5 × 2,5	5/8" - 3/8"	840 / 240 / 840	<b>4.807 €</b>
<b>UM CST 48 3F</b>	3NGR2110	13400 / 15500 W	A+ / A	5 × 2,5	5/8" - 3/8"	840 / 240 / 840	<b>5.229 €</b>
<b>UM CST 60 3F</b>	3NGR2115	14500 / 17000 W	A++ / A	5 × 2,5	5/8" - 3/8"	840 / 240 / 840	<b>5.379 €</b>

**NUEVO**

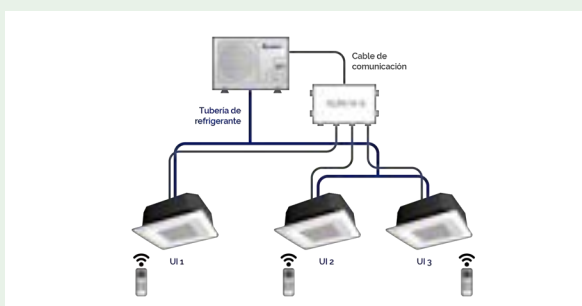

**KIT MULTI U-MATCH**  
3NGR9051

Posibilidad de combinación como multisplit twin, tri o quadri.  
Ver tablas de combinaciones y anexos para mas información.



## U-MATCH CASSETTE 360°

La solución tecnológica e innovadora para los espacios comerciales.



**WIFI INTEGRADO**  
Control total de la unidad a distancia con la app GREE+.

**MÁXIMO CONFORT**

- Difusión de aire 360°
- Filtros purificadores

**A++ R32**

**MÁXIMO AHORRO ENERGÉTICO Y RESPETO POR EL MEDIO AMBIENTE**

- Clase energética A++
- Gas ecológico R32

**UNIDAD EXTERIOR DE UN SOLO VENTILADOR HASTA 14 kW**  
Hasta un 35% más compacta y un 13% más ligera que la serie R410.



## SUELO/TECHO

UNIDADES U-MATCH



Control WiFi opcional. Swing horizontal. Swing vertical. Swing automatico. Standby 1W. Turbo cooling. Modo ahorro de energía. Modo fuera de casa. Modo sleep. Alta eficiencia. Auto clean X-Fan. Desescarche inteligente. Deshumidificador. Función pre-calefacción. Ventilador multi-velocidad. Aviso de limpieza de filtros. Control centralizado opcional. Control de pared opcional. Control paro/marcha opcional. Control remoto led. Diseño compacto. Tecnología Inverter DC. Temporizador 24h. Temporizador semanal opcional. Bloqueo de funciones. Encendido progresivo. Compatible mono & multi opcional. Protección Blue fin.

### MONOFÁSICO

MODELO	CÓDIGO	POTENCIA	CLASE ENERG.	CABLE ALIM. UE	Ø GAS / LÍQUIDO	DIMENSIONES UI	PVR*
UM ST 12	3NGR3065	3500 / 4000 W	A++ / A+	3 × 1,5	3/8" - 1/4"	870 / 235 / 665	2.031 €
UM ST 18	3NGR3070	5000 / 5500 W	A++ / A+	3 × 1,5	1/2" - 1/4"	870 / 235 / 665	2.324 €
UM ST 24	3NGR3075	7000 / 8000 W	A++ / A+	3 × 1,5	5/8" - 3/8"	870 / 235 / 665	2.467 €
UM ST 30	3NGR3080	8500 / 8800 W	A++ / A+	3 × 1,5	5/8" - 3/8"	870 / 235 / 665	3.253 €
UM ST 36	3NGR3085	10000 / 12000 W	A++ / A+	3 × 1,5	5/8" - 3/8"	870 / 235 / 665	3.686 €
UM ST 42	3NGR3090	12100 / 13500 W	A+ / A	3 × 1,5	5/8" - 3/8"	870 / 235 / 665	4.268 €
UM ST 48	3NGR3095	13400 / 15500 W	A++ / A	3 × 1,5	5/8" - 3/8"	870 / 235 / 665	4.604 €

### TRIFÁSICO

MODELO	CÓDIGO	POTENCIA	CLASE ENERG.	CABLE ALIM. UE	Ø GAS / LÍQUIDO	DIMENSIONES UI	PVR*
UM ST 36 3F	3NGR3100	10000 / 12000 W	A++ / A+	5 × 2,5	5/8" - 3/8"	1200 / 235 / 665	4.547 €
UM ST 42 3F	3NGR3105	12100 / 13500 W	A+ / A	5 × 2,5	5/8" - 3/8"	1200 / 235 / 665	5.068 €
UM ST 48 3F	3NGR3110	13400 / 15500 W	A+ / A	5 × 2,5	5/8" - 3/8"	1200 / 235 / 665	5.330 €
UM ST 60 3F	3NGR3115	16000 / 17000 W	A++ / A	5 × 2,5	5/8" - 3/8"	1200 / 235 / 665	5.506 €

# COLUMNAS



## T-FRESH

COLUMNA DE DISEÑO ELEGANTE



Control WiFi. Aire 3D. Swing horizontal. Swing vertical. Swing automatico. Turbo cooling. Modo ahorro de energía. Modo automático. Modo sleep. Auto clean X-Fan. Desescarche inteligente. Deshumidificador. Función pre-calefacción. Ventilador multi-velocidad. Control remoto led. Tecnología Inverter DC. Temporizador 24h. Bloqueo de funciones. Indicador LED. Protección Blue fin.

MODELO	CÓDIGO	POTENCIA	SEER / SCOP	CABLE ALIM. UE	Ø GAS / LÍQUIDO	DIMENSIONES UI	PVR*
T-FRESH 24	3NGR0170	7200 / 7900 W	6.1 / 4	2 x 2,5 +T	5/8" - 1/4"	507 / 1770 / 320	3.164 €
T-FRESH 48	3NGR0175	12500 / 13700 W	5.6 / 3.8	2 x 2,5 +T	5/8" - 3/8"	507 / 1770 / 320	4.988 €
T-FRESH 48 3F	3NGR0285	12500 / 13700 W	6.1 / 4	2 x 2,5 +T	5/8" - 3/8"	507 / 1770 / 320	5.030 €

# VENTANAS



## COOLANI

AIRE DE VENTANA CON UNA PRACTICA DISTRIBUCIÓN DEL AIRE



Swing vertical. Swing automatico. Modo automático. Modo sleep. Deshumidificador. Ventilador multi-velocidad. Aviso de limpieza de filtros. Control remoto led. Renovación de aire. Tecnología Inverter DC. Temporizador 24h. Indicador LED. Encendido progresivo. Protección Blue fin.

MODELO	CÓDIGO	POTENCIA	CABLE ALIM.	Ø GAS / LÍQUIDO	DIMENSIONES	PVR*
COOLANI 9	3NGR0200	2700 / - W	-	-	560 / 375 / 708	1.105 €
COOLANI 12	3NGR0201	3650 / - W	-	-	660 / 428 / 700	1.225 €

# CORTINAS



## CORTINA DE AIRE

SISTEMA ANTI-PÉRDIDA DE CALOR



Ventilador multi-velocidad. Control remoto led. Diseño compacto. Facilidad de mantenimiento.

MODELO	CÓDIGO	VOLUMEN DE AIRE	CABLE ALIM.	Ø GAS / LÍQUIDO	DIMENSIONES	PVR*
CORT 110	3NGR8000	1200 m <sup>3</sup> /h	-	-	900 / 193 / 215	445 €
CORT 140	3NGR8001	1650 m <sup>3</sup> /h	-	-	1200 / 193 / 215	492 €

# AC CARAVANAS

NUEVO



## GOCOOL

EL AIRE DE TECHO QUE TE ACOMPAÑA EN LAS AVENTURAS



Control WiFi. Swing vertical. Swing automatico. Turbo cooling. Modo sleep. Auto clean X-Fan. Deshumidificador. Aviso de limpieza de filtros. Control remoto led. Diseño compacto. Temporizador 24h. Bloqueo de funciones. Indicador LED.

MODELO	CÓDIGO	POTENCIA	CABLE ALIM.	Ø GAS / LÍQUIDO	DIMENSIONES UE	DIMENSIONES UI	PVR*
GOCOOL 85	3NGR7015	2600 / 2400 W	2 x 2,5 + T	-	1077 / 283 / 720	610 / 49 / 485	2.750 €
GOCOOL 120	3NGR7020	3600 / 3400 W	2 x 2,5 + T	-	1077 / 283 / 720	610 / 49 / 485	2.879 €



# INDUSTRIAL

## POTENCIA FRIGORÍFICA (kW)

12

14

16

20

22.4

25

28

### CONDUCTOS DE ALTA CAPACIDAD



BIG DUCT

3NGR3520

3NGR3525

### UNIDADES EXTERIORES GMV



GMV5 MINI

3IGR0049  
3IGR00533IGR0054  
3IGR00723IGR0052  
3IGR0055

GMV5 SLIM

3IGR0056

3IGR0057



GMV6

3IGR0100

3IGR0101



GMV6 HEAT RECOVERY

**NUEVO**  
3IGR0108

**NUEVO**  
3IGR0109

GMV5 HEAT RECOVERY

3IGR0067

3IGR0068



GMV5 SOLAR

3IGR0082

3IGR0083

3IGR0084

## POTENCIA FRIGORÍFICA (kW)

1.5

1.8

2.2

2.5

2.8

3.2

3.6

4

4.5

5

5.6

### UNIDADES INTERIORES GMV

CONDUCTOS DE PRESIÓN  
REGULABLE DE 0 HASTA 200 PA

3IGR1115

3IGR1116

3IGR1117

3IGR1118

3IGR1119

3IGR1120

3IGR1121

3IGR1122

3IGR1123

CONDUCTOS DE PRESIÓN  
REGULABLE DE 0 HASTA 50 PA

3IGR1046

3IGR1028

3IGR1029

3IGR1030

3IGR1031

3IGR1032

3IGR1033

3IGR1034

3IGR1035

3IGR1036

CONDUCTOS DE PRESIÓN  
REGULABLE DE 50 HASTA 200 PACONDUCTOS DE RENOVACIÓN  
DE AIRE

CASSETTES 600×600

3IGR2029K

3IGR2030K

3IGR2031K

3IGR2032K

3IGR2033K

3IGR2034K

3IGR2035K



CASSETTES 900×900



CASSETTES 2 VÍAS

**NUEVO**  
3IGR2207K

**NUEVO**  
3IGR2208K

**NUEVO**  
3IGR2209K

**NUEVO**  
3IGR2210K

**NUEVO**  
3IGR2211K

CASSETTES 1 VÍA

3IGR2100K

3IGR2101K

3IGR2102K

3IGR2103K

3IGR2104K



MURAL DESIGN

3IGR4017

3IGR4008

3IGR4009

3IGR4010

3IGR4011

3IGR4012

3IGR4013



SUELO/TECHO

**NUEVO**  
3IGR3009

**NUEVO**  
3IGR3010

**NUEVO**  
3IGR3011







**NUEVO**  
3IGR3012

POTENCIA FRIGORÍFICA (kW)							Pág.
30	33.5	40	45	50.4	56	61.5	
3NGR3530		3NGR3535					32
							33
	3IGR0058						33
	3IGR0102	3IGR0103	3IGR0104	3IGR0105	3IGR0106	3IGR0107	34
	<b>NUEVO</b> 3IGR0110	<b>NUEVO</b> 3IGR0111	<b>NUEVO</b> 3IGR0112	<b>NUEVO</b> 3IGR0113	<b>NUEVO</b> 3IGR0114	<b>NUEVO</b> 3IGR0115	35
	3IGR0069	3IGR0070	3IGR0071				33
							35

POTENCIA FRIGORÍFICA (kW)													Pág.
6.3	7.1	8	9	10	11.2	12.5	14	16	22.4	25	28	45	
3IGR1124	3IGR1125	3IGR1126	3IGR1127	3IGR1128	3IGR1129	3IGR1130	3IGR1131	3IGR1132					36
3IGR1037	3IGR1038												37
									3IGR1110		3IGR1111		37
						3IGR1206	3IGR1207		3IGR1208	3IGR1209	3IGR1210	3IGR1205	38
													38
3IGR2041K	3IGR2042K	3IGR2043K	3IGR2044K	3IGR2045K	3IGR2046K	3IGR2047K	3IGR2048K						38
<b>NUEVO</b> 3IGR2212K	<b>NUEVO</b> 3IGR2213K	<b>NUEVO</b> 3IGR2214K											39
													39
3IGR4014	3IGR4015												39
<b>NUEVO</b> 3IGR3013	<b>NUEVO</b> 3IGR3014		<b>NUEVO</b> 3IGR3015		<b>NUEVO</b> 3IGR3016	<b>NUEVO</b> 3IGR3017	<b>NUEVO</b> 3IGR3018	<b>NUEVO</b> 3IGR3019					40

		POTENCIA FRIGORÍFICA (kW)										
		1.5	1.8	2.2	2.5	2.8	3.2	3.6	4	4.5	5	5.6
<b>UNIDADES INTERIORES GMV</b>												
	CONSOLA			3IGR3100		3IGR3101		3IGR3102		3IGR3103	3IGR3104	
	CONDUCTOS VERTICALES			<b>NUEVO</b> 3IGR1048		<b>NUEVO</b> 3IGR1049		<b>NUEVO</b> 3IGR1050		<b>NUEVO</b> 3IGR1051		<b>NUEVO</b> 3IGR1052
	COLUMNA											
	KIT UTA											

		POTENCIA FRIGORÍFICA (kW)										
		32										
<b>ENFRIADORAS</b>												
	CHILLER MODULAR INVERTER											3ICG0013

		POTENCIA FRIGORÍFICA (kW)										
		1.5	2	2.5	3	3.5	4	4.5	5	5.5		
<b>FANCOILS</b>												
	CONSOLAS	<b>NUEVO</b> 3IGR7208	<b>NUEVO</b> 3IGR7209	<b>NUEVO</b> 3IGR7210	<b>NUEVO</b> 3IGR7211					<b>NUEVO</b> 3IGR7212		
	CONDUCTOS 2 TUBOS		3IGR7063		3IGR7064	3IGR7072		3IGR7073				3IGR7067
	CONDUCTOS 4 TUBOS			3IGR7079			3IGR7080	3IGR7081				3IGR7082
	CASSETTES 2 TUBOS				3IGR7115K	3IGR7116K		3IGR7106K	3IGR7107K			
	CASSETTES 4 TUBOS					3IGR7100K	3IGR7101K					
	MURAL	3IGR7300		3IGR7301		3IGR7302	3IGR7303					
	SUELO/TECHO	3IGR7200		3IGR7201	3IGR7202	3IGR7203			3IGR7204		3IGR7205	



POTENCIA FRIGORÍFICA (kW)												Pág.	
6.3	7.1	8	9	10	11.2	12.5	14	16	22.4	25	28	45	
													40
<b>NUEVO</b> 3IGR1053	<b>NUEVO</b> 3IGR1054												37
				3IGR3200			3IGR3201						40
			3IGR9000						3IGR9001			3IGR9002	40

POTENCIA FRIGORÍFICA (kW)												Pág.	
60													
													41
							3ICG0014						

POTENCIA FRIGORÍFICA (kW)												Pág.	
6	6.5	7	8	8.5	9.5	10	10.5	13					
<b>NUEVO</b> 3IGR7213	<b>NUEVO</b> 3IGR7214	<b>NUEVO</b> 3IGR7215						<b>NUEVO</b> 3IGR7216	<b>NUEVO</b> 3IGR7217				42
3IGR7075		3IGR7068	3IGR7076	3IGR7069		3IGR7070	3IGR7078						42
	3IGR7083			3IGR7084		3IGR7085	3IGR7086						42
3IGR7108K			3IGR7109K	3IGR7110K	3IGR7111K				3IGR7112K				43
3IGR7102K			3IGR7103K										43
													43
		3IGR7207				3IGR7206							43

# CONDUCTOS DE ALTA CAPACIDAD



## BIG DUCT

CONDUCTOS DE GRAN POTENCIA Y ALTA PRESIÓN ESTÁTICA



Turbo cooling. Modo ahorro de energía. Alta eficiencia. Auto clean X-Fan. Desescarche inteligente. Deshumidificador. Función pre-calefacción. Ventilador multi-velocidad. Control de pared. Control paro/marcha opcional. Control por cable (maestro/esclavo). Control remoto led opcional. Diseño compacto. Facilidad de mantenimiento. Tecnología Inverter DC. Temporizador 24h. Bloqueo de funciones. Encendido progresivo.

MODELO	CÓDIGO	POTENCIA	SEER / SCOP	CABLE ALIM. UE	Ø GAS / LÍQUIDO	DIMENSIONES UI	PVR*
BIG CDT 20	3NGR3520	20 / 22 kW	4.77 / 3.34	4 x 2.5 + T	3/4" - 3/8"	1460 / 365 / 790	8.303 €
BIG CDT 25	3NGR3525	25 / 27.5 kW	4.53 / 3.53	4 x 2.5 + T	7/8" - 3/8"	1460 / 365 / 790	9.662 €
BIG CDT 30	3NGR3530	30 / 33 kW	4.63 / 3.33	4 x 2.5 + T	1" - 1/2"	1460 / 365 / 790	10.665 €
BIG CDT 40	3NGR3535	40 / 43 kW	4.53 / 3.35	4 x 2.5 + T	2 x 3/4" - 2 x 3/8"	1460 / 365 / 790	14.724 €

**GREE**  
ALTA TECNOLOGÍA  
EN CLIMATIZACIÓN

## GMV5 MINI

El VRF de pequeña potencia más compacto y eficiente.

FUNCIONAMIENTO  
BAJO TEMPERATURAS  
EXTREMAS  
De -20°C a +52°C.

MÁXIMA  
VERSATILIDAD  
DE INSTALACIÓN  
Hasta 300 m de  
tubería frigorífica.



MÁXIMO AHORRO  
ENERGÉTICO  
Certificada Eurovent.

UNIDAD EXTERIOR DE  
UN SOLO VENTILADOR

- De 12 y 14 kW
- 8 unidades interiores conectables
- Hasta un 22% más ligera y un 60% menos de carga de gas



# UNIDADES EXTERIORES GMV



## GMV5 MINI UNIDADES EXTERIORES GMV



Modo ahorro de energía. Alta eficiencia. Desescarche inteligente. Amplio rango de tensión. Cobre con estriamiento interior. Control centralizado opcional. Direccionamiento automático. Diseño compacto. Facilidad de mantenimiento. Golden fin. Grandes distancias frigoríficas. Supervisión remota opcional. Tecnología Inverter DC. Modo silencioso.

MODELO	CÓDIGO	POTENCIA	SEER / SCOP	CABLE ALIM.	Ø GAS / LÍQUIDO	DIMENSIONES	PVR*
GMV5 MINI 121	3IGR0049	12.1 / 12.1 kW	6.11 / 3.87	2 × 2.5 + T	5/8" - 3/8"	980 / 790 / 360	3.810 €
GMV5 MINI 141	3IGR0072	14.1 / 14.1 kW	5.85 / 3.74	2 × 2.5 + T	5/8" - 3/8"	940 / 820 / 460	4.099 €
GMV5 MINI 160	3IGR0052	16 / 16 kW	6.96 / 4.04	2 × 2.5 + T	3/4" - 3/8"	900 / 1345 / 340	4.567 €
GMV5 MINI 120 3F	3IGR0053	12.1 / 12.1 kW	6.7 / 3.97	4 × 1.5 + T	5/8" - 3/8"	900 / 1345 / 340	4.726 €
GMV5 MINI 140 3F	3IGR0054	14 / 14 kW	6.88 / 4.24	4 × 1.5 + T	5/8" - 3/8"	900 / 1345 / 340	4.821 €
GMV5 MINI 160 3F	3IGR0055	16 / 16 kW	6.96 / 4.04	4 × 1.5 + T	3/4" - 3/8"	900 / 1345 / 340	4.938 €



## GMV5 SLIM UNIDADES EXTERIORES GMV



Modo ahorro de energía. Alta eficiencia. Desescarche inteligente. Amplio rango de tensión. Cobre con estriamiento interior. Control centralizado opcional. Direccionamiento automático. Diseño compacto. Facilidad de mantenimiento. Golden fin. Grandes distancias frigoríficas. Supervisión remota opcional. Tecnología Inverter DC. Modo silencioso.

MODELO	CÓDIGO	POTENCIA	SEER / SCOP	CABLE ALIM.	Ø GAS / LÍQUIDO	DIMENSIONES	PVR*
GMV5 SLIM 224	3IGR0056	22.4 / 22.4 kW	6.85 / 4.27	4 × 2.5 + T	3/4" - 3/8"	940 / 1430 / 320	6.682 €
GMV5 SLIM 280	3IGR0057	28 / 28 kW	6.16 / 4.59	4 × 2.5 + T	7/8" - 3/8"	940 / 1615 / 460	7.699 €
GMV5 SLIM 335	3IGR0058	33.5 / 33.5 kW	6.98 / 4.58	4 × 2.5 + T	1" - 1/2"	940 / 1615 / 460	8.698 €



## GMV5 HEAT RECOVERY UNIDADES EXTERIORES GMV



Alta eficiencia. Desescarche inteligente. Amplio rango de tensión. Cobre con estriamiento interior. Control centralizado opcional. Direccionamiento automático. Diseño compacto. Estructura modular. Facilidad de mantenimiento. Funcionamiento modular. Golden fin. Grandes distancias frigoríficas. Supervisión remota opcional. Tecnología Inverter DC. Modo silencioso.

MODELO	CÓDIGO	POTENCIA	SEER / SCOP	CABLE ALIM.	Ø GAS / LÍQUIDO	DIMENSIONES	PVR*
GMV5 HR 224	3IGR0067	22.4 / 25 kW	6.83 / 4.53	4 × 2.5 + T	3/4" - 3/8"	930 / 1605 / 765	9.824 €
GMV5 HR 280	3IGR0068	28 / 31.5 kW	9.22 / 4.76	4 × 2.5 + T	7/8" - 3/8"	930 / 1605 / 765	10.410 €
GMV5 HR 335	3IGR0069	33.5 / 37.5 kW	7.59 / 4.8	4 × 4 + T	1" - 1/2"	1340 / 1605 / 765	11.436 €
GMV5 HR 400	3IGR0070	40 / 45 kW	7.28 / 4.16	4 × 6 + T	1" - 1/2"	1340 / 1605 / 765	13.626 €
GMV5 HR 450	3IGR0071	45 / 50 kW	6.41 / 4	4 × 6 + T	1 1/8" - 1/2"	1340 / 1605 / 765	14.750 €

\*Disponible hasta fin de existencias.

## MÓDULOS CONECTORES

MODELO	CÓDIGO	POTENCIA	SEER / SCOP	CABLE ALIM.	Ø GAS / LÍQUIDO	DIMENSIONES	PVR*
GMV5 HR CM1C	3IGR9003	-	-	-	5/8" - 3/8"	388 / 225 / 301	1.035 €
GMV5 HR CM2C	3IGR9006	-	-	-	5/8" - 3/8"	468 / 225 / 377	1.722 €
GMV5 HR CM4C	3IGR9004	-	-	-	5/8" - 3/8"	586 / 225 / 398	2.618 €
GMV5 HR CM8C	3IGR9005	-	-	-	5/8" - 3/8"	987 / 225 / 488	5.627 €

\*Disponible hasta fin de existencias.



## GMV6

UNIDADES EXTERIORES GMV



Standby 1W. Modo ahorro de energía. Alta eficiencia. Desescarche inteligente. Amplio rango de tensión. Control centralizado opcional. Direccionamiento automático. Diseño compacto. Estructura modular. Facilidad de mantenimiento. Funcionamiento modular. Golden fin. Grandes distancias frigoríficas. Supervisión remota opcional. Tecnología Inverter DC. Modo silencioso.

MODELO	CÓDIGO	POTENCIA	SEER / SCOP	CABLE ALIM.	Ø GAS / LÍQUIDO	DIMENSIONES	PVR*
GMV6 224	3IGR0100	22.40 / 22.40 kW	7.1 / 4.62	4 × 2,5 + T	3/4" - 3/8"	930 / 1690 / 775	9.082 €
GMV6 280	3IGR0101	28.00 / 28.00 kW	6.59 / 4.8	4 × 2,5 + T	7/8" - 3/8"	930 / 1690 / 775	9.910 €
GMV6 335	3IGR0102	33.50 / 33.50 kW	6.31 / 4.4	4 × 4 + T	1" - 1/2"	930 / 1690 / 775	11.827 €
GMV6 400	3IGR0103	40.00 / 40.00 kW	6.68 / 4.8	4 × 6 + T	1" - 1/2"	1340 / 1690 / 775	13.672 €
GMV6 450	3IGR0104	50.40 / 50.40 kW	6.06 / 4.19	4 × 6 + T	1-1/8" - 1/2"	1340 / 1690 / 775	15.536 €
GMV6 504	3IGR0105	45.00 / 45.00 kW	6.17 / 4.84	4 × 10 + T	1-1/8" - 5/8"	1340 / 1690 / 775	16.266 €
GMV6 560	3IGR0106	52.00 / 56.00 kW	5.97 / 4.11	4 × 10 + T	1-1/8" - 5/8"	1340 / 1690 / 775	17.224 €
GMV6 615	3IGR0107	52.00 / 56.00 kW	5.97 / 4.11	4 × 10 + T	1-1/8" - 5/8"	1340 / 1690 / 775	18.583 €



## GMV6

La nueva generación VRF que se adapta a cualquier entorno.

### CONFORT Y AHORRO SIN PRECEDENTES

- 9 modos noche silenciosos automáticos.
- Los desescarches pasan desapercibidos.
- Consumo de 1W en Stand-by.

### FACILIDAD DE INTEGRACIÓN A TODO TIPO DE EDIFICIO

Presión estática del grupo: 110Pa máximo.

### CALEFACCIÓN A MUY BAJA TEMPERATURA

- Gracias al compresor EVI Enhanced Vapor Injection el GMV6 inyecta solamente lo necesario.
- 5 mejoras del retorno de aceite garantizan el funcionamiento hasta -30°C.

### PERO TAMBIÉN...

- Frío hasta 55°C exteriores.
- Hasta 100 unidades interiores conectables.



NUEVO



# GMV6 HEAT RECOVERY

UNIDADES EXTERIORES GMV



Alta eficiencia. Desescarche inteligente. Amplio rango de tensión. Cobre con estriamiento interior. Control centralizado opcional. Control inteligente. Direccionamiento automático. Diseño compacto. Estructura modular. Facilidad de mantenimiento. Funcionamiento modular. Golden fin. Grandes distancias frigoríficas. Supervisión remota opcional. Tecnología Inverter DC. Modo silencioso.

MODELO	CÓDIGO	POTENCIA	SEER / SCOP	CABLE ALIM.	Ø GAS / LÍQUIDO	DIMENSIONES	PVR*
GMV6 HR 224	3IGR0108	22.4 / 22.4 kW	7 / 4.32	4 × 2,5 + T	3/4" - 3/8"	930 / 1690 / 775	10.050 €
GMV6 HR 280	3IGR0109	28 / 28 kW	6.7 / 4.58	4 × 2,5 + T	7/8" - 3/8"	930 / 1690 / 775	10.699 €
GMV6 HR 335	3IGR0110	33.5 / 33.5 kW	6.55 / 4.74	4 × 4 + T	1" - 1/2"	930 / 1690 / 775	12.030 €
GMV6 HR 400	3IGR0111	40 / 40 kW	6.91 / 4.44	4 × 6 + T	1" - 1/2"	1340 / 1690 / 775	14.593 €
GMV6 HR 450	3IGR0112	45 / 45 kW	6.46 / 4.42	4 × 6 + T	1-1/8" - 1/2"	1340 / 1690 / 775	16.695 €
GMV6 HR 504	3IGR0113	50.4 / 50.4 kW	6.48 / 4.25	4 × 10 + T	1-1/8" - 5/8"	1340 / 1690 / 775	17.519 €
GMV6 HR 560	3IGR0114	52 / 56 kW	6.32 / 4.15	4 × 10 + T	1-1/8" - 5/8"	1340 / 1690 / 775	17.836 €
GMV6 HR 615	3IGR0115	52 / 56 kW	6.32 / 4.15	4 × 10 + T	1-1/8" - 5/8"	1340 / 1690 / 775	18.095 €

## MÓDULOS CONECTORES

MODELO	CÓDIGO	POTENCIA	SEER / SCOP	CABLE ALIM.	Ø GAS / LÍQUIDO	DIMENSIONES	PVR*
GMV6 HR CM1D	3IGR9015	-	-	-	1/2 - 5/8" - 1/4 - 3/8"	340 / 388 / 250	1.183 €
GMV6 HR CM2D	3IGR9016	-	-	-	1/2 - 5/8" - 1/4 - 3/8"	340 / 388 / 250	1.680 €
GMV6 HR CM4D	3IGR9017	-	-	-	1/2 - 5/8" - 1/4 - 3/8"	460 / 388 / 250	2.789 €
GMV6 HR CM8D	3IGR9018	-	-	-	1/2 - 5/8" - 1/4 - 3/8"	784 / 380 / 250	5.175 €



# GMV5 SOLAR

UNIDADES EXTERIORES GMV



Modo ahorro de energía. Alta eficiencia. Desescarche inteligente. Amplio rango de tensión. Cobre con estriamiento interior. Control centralizado opcional. Direccionamiento automático. Diseño compacto. Facilidad de mantenimiento. Golden fin. Grandes distancias frigoríficas. Supervisión remota opcional. Tecnología Inverter DC. Modo silencioso.

MODELO	CÓDIGO	POTENCIA	SEER / SCOP	CABLE ALIM.	Ø GAS / LÍQUIDO	DIMENSIONES	PVR*
GMV5 PV 120	3IGR0082	12.1 / 14 kW	-	-	5/8" - 3/8"	900 / 1345 / 340	9.706 €
GMV5 PV 140	3IGR0083	14 / 16 kW	-	-	5/8" - 3/8"	900 / 1345 / 340	9.968 €
GMV5 PV 160	3IGR0084	16 / 18 kW	-	-	3/4" - 3/8"	900 / 1345 / 340	10.219 €

\*Paneles solares no incluidos. Consultar la disponibilidad.

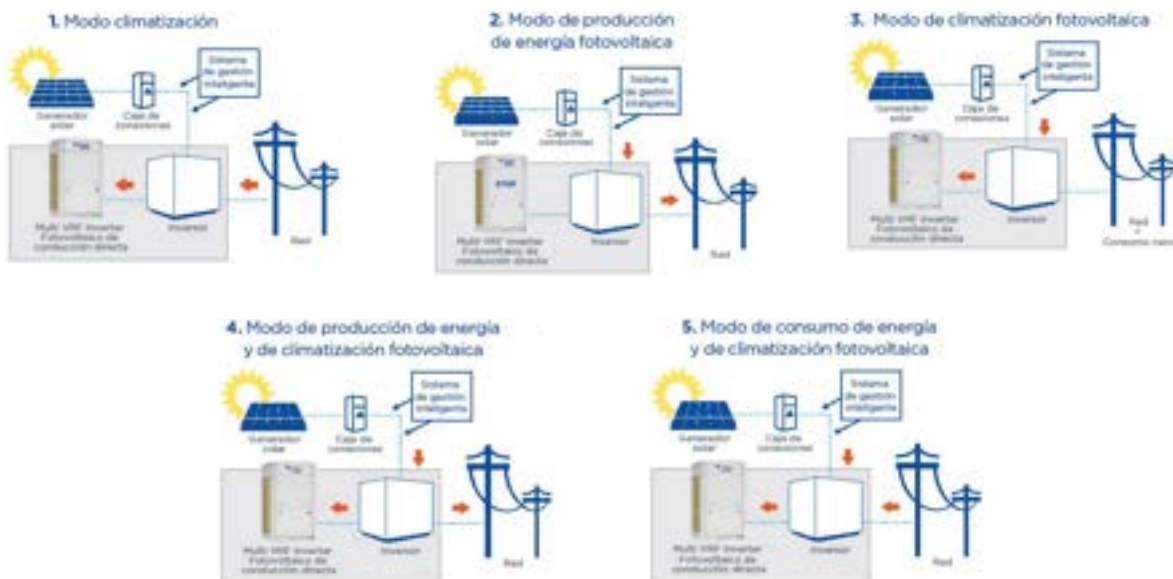

## GMV5 FOTOVOLTAICO

El primer sistema VRF con alimentación fotovoltaica directa.

### INSTALACIÓN FLEXIBLE

Compatibilidad con todo tipo de paneles solares y todas las unidades interiores GMV5.

98 % DE LA ENERGÍA RECUPERADA

7 % más eficiente que los sistemas tradicionales gracias a la alimentación directa del módulo inverter con corriente continua.

### 5 MODOS DE FUNCIONAMIENTO AUTOMÁTICOS

Si se genera más energía fotovoltaica de lo necesario, el excedente se envía a la red.

### TECNOLOGÍA PUNTA

- Múltiples galardones recibidos en todo el mundo, como los Innovation Awards de Interclima 2019
- 40 patentes registradas



## UNIDADES INTERIORES GMV



### CONDUCTOS LIGEROS 1.5

UNIDADES INTERIORES GMV



Control WiFi opcional. Modo ahorro de energía. Modo fuera de casa. Modo sleep. I Feel opcional. Alta eficiencia. Auto clean X-Fan. Alta presión estática. Bomba de drenaje incorporada. Control centralizado opcional. Control de pared. Control paro/marcha opcional. Control por cable (maestro/esclavo). Control remoto led opcional. Direccionamiento automático. Motor de alto rendimiento.

### CONDUCTOS DE PRESIÓN REGULABLE DE 0 HASTA 200 PA

MODELO	CÓDIGO	POTENCIA	SEER / SCOP	CABLE ALIM.	Ø GAS / LÍQUIDO	DIMENSIONES	PVR*
GMV5 CDT 22HP 1.5	3IGR1115	2.2 / 2.5 kW	-	2 × 1,5 + T	3/8" - 1/4"	700 / 300 / 700	1.090 €
GMV5 CDT 25HP 1.5	3IGR1116	2.5 / 2.8 kW	-	2 × 1,5 + T	3/8" - 1/4"	700 / 300 / 700	1.119 €
GMV5 CDT 28HP 1.5	3IGR1117	2.8 / 3.2 kW	-	2 × 1,5 + T	3/8" - 1/4"	700 / 300 / 700	1.139 €
GMV5 CDT 32HP 1.5	3IGR1118	3.2 / 3.6 kW	-	2 × 1,5 + T	1/2" - 1/4"	700 / 300 / 700	1.164 €
GMV5 CDT 36HP 1.5	3IGR1119	3.6 / 4 kW	-	2 × 1,5 + T	1/2" - 1/4"	700 / 300 / 700	1.185 €
GMV5 CDT 40HP 1.5	3IGR1120	4 / 4.5 kW	-	2 × 1,5 + T	1/2" - 1/4"	700 / 300 / 700	1.269 €
GMV5 CDT 45HP 1.5	3IGR1121	4.5 / 5 kW	-	2 × 1,5 + T	1/2" - 1/4"	700 / 300 / 700	1.313 €
GMV5 CDT 50HP 1.5	3IGR1122	5 / 5.6 kW	-	2 × 1,5 + T	1/2" - 1/4"	700 / 300 / 700	1.346 €
GMV5 CDT 56HP 1.5	3IGR1123	5.6 / 6.3 kW	-	2 × 1,5 + T	5/8" - 3/8"	1000 / 300 / 700	1.382 €
GMV5 CDT 63HP 1.5	3IGR1124	6.3 / 7.1 kW	-	2 × 1,5 + T	5/8" - 3/8"	1000 / 300 / 700	1.421 €
GMV5 CDT 71HP 1.5	3IGR1125	7.1 / 8 kW	-	2 × 1,5 + T	5/8" - 3/8"	1000 / 300 / 700	1.564 €
GMV5 CDT 80HP 1.5	3IGR1126	8 / 9 kW	-	2 × 1,5 + T	5/8" - 3/8"	1000 / 300 / 700	1.652 €
GMV5 CDT 90HP 1.5	3IGR1127	9 / 10 kW	-	2 × 1,5 + T	5/8" - 3/8"	1400 / 300 / 700	1.839 €
GMV5 CDT 100HP 1.5	3IGR1128	10 / 11.2 kW	-	2 × 1,5 + T	5/8" - 3/8"	1400 / 300 / 700	1.863 €
GMV5 CDT 112HP 1.5	3IGR1129	11.2 / 12.5 kW	-	2 × 1,5 + T	5/8" - 3/8"	1400 / 300 / 700	1.902 €
GMV5 CDT 125HP 1.5	3IGR1130	12.5 / 14 kW	-	2 × 1,5 + T	5/8" - 3/8"	1400 / 300 / 700	1.965 €
GMV5 CDT 140HP 1.5	3IGR1131	14 / 16 kW	-	2 × 1,5 + T	5/8" - 3/8"	1400 / 300 / 700	2.120 €
GMV5 CDT 160HP 1.5	3IGR1132	16 / 18 kW	-	2 × 1,5 + T	3/4" - 3/8"	1400 / 300 / 700	2.256 €

## CONDUCTOS DE PRESIÓN REGULABLE DE 0 HASTA 50 PA

MODELO	CÓDIGO	POTENCIA	SEER / SCOP	CABLE ALIM.	Ø GAS / LÍQUIDO	DIMENSIONES	PVR*
GMV5 CDT 18LP 1.5	3IGR1046	1.8 / 2.2 kW	-	2 × 1,5 + T	3/8" - 1/4"	710 / 200 / 462	<b>947 €</b>
GMV5 CDT 22LP 1.5	3IGR1028	2.2 / 2.5 kW	-	2 × 1,5 + T	3/8" - 1/4"	710 / 200 / 462	<b>969 €</b>
GMV5 CDT 25LP 1.5	3IGR1029	2.5 / 2.8 kW	-	2 × 1,5 + T	3/8" - 1/4"	710 / 200 / 462	<b>997 €</b>
GMV5 CDT 28LP 1.5	3IGR1030	2.8 / 3.2 kW	-	2 × 1,5 + T	3/8" - 1/4"	710 / 200 / 462	<b>1.014 €</b>
GMV5 CDT 32LP 1.5	3IGR1031	3.2 / 3.6 kW	-	2 × 1,5 + T	1/2" - 1/4"	710 / 200 / 462	<b>1.028 €</b>
GMV5 CDT 36LP 1.5	3IGR1032	3.6 / 4 kW	-	2 × 1,5 + T	1/2" - 1/4"	710 / 200 / 462	<b>1.044 €</b>
GMV5 CDT 40LP 1.5	3IGR1033	4 / 4.5 kW	-	2 × 1,5 + T	1/2" - 1/4"	1010 / 200 / 462	<b>1.130 €</b>
GMV5 CDT 45LP 1.5	3IGR1034	4.5 / 5 kW	-	2 × 1,5 + T	1/2" - 1/4"	1010 / 200 / 462	<b>1.171 €</b>
GMV5 CDT 50LP 1.5	3IGR1035	5 / 5.6 kW	-	2 × 1,5 + T	1/2" - 1/4"	1010 / 200 / 462	<b>1.198 €</b>
GMV5 CDT 56LP 1.5	3IGR1036	5.6 / 6.3 kW	-	2 × 1,5 + T	5/8" - 3/8"	1010 / 200 / 462	<b>1.256 €</b>
GMV5 CDT 63LP 1.5	3IGR1037	6.3 / 7.1 kW	-	2 × 1,5 + T	5/8" - 3/8"	1010 / 200 / 462	<b>1.291 €</b>
GMV5 CDT 71LP 1.5	3IGR1038	7.1 / 8 kW	-	2 × 1,5 + T	5/8" - 3/8"	1310 / 200 / 462	<b>1.419 €</b>



## CONDUCTOS UNIDADES INTERIORES GMV



Modo ahorro de energía. I Feel opcional. Alta eficiencia. Alta presión estática. Control centralizado opcional. Control de pared. Control paro/marcha opcional. Control por cable (maestro/esclavo). Control remoto led opcional. Dirección automática. Facilidad de mantenimiento. Motor de alto rendimiento. Modo silencioso.

## CONDUCTOS DE PRESIÓN REGULABLE DE 50 HASTA 200 PA

MODELO	CÓDIGO	POTENCIA	SEER / SCOP	CABLE ALIM.	Ø GAS / LÍQUIDO	DIMENSIONES	PVR*
GMV5 CDT 224HP	3IGR1110	22.4 / 25 kW	-	2 × 1,5 + T	3/4" - 3/8"	1483 / 385 / 791	<b>2.618 €</b>
GMV5 CDT 280HP	3IGR1111	28 / 31 kW	-	2 × 1,5 + T	7/8" - 3/8"	1686 / 450 / 870	<b>2.935 €</b>

**NUEVO**



## CONDUCTOS VERTICALES UNIDADES INTERIORES GMV



Modo ahorro de energía. I Feel opcional. Alta eficiencia. Alta presión estática. Control centralizado opcional. Control de pared. Control paro/marcha opcional. Control por cable (maestro/esclavo). Control remoto led opcional. Dirección automática. Facilidad de mantenimiento. Motor de alto rendimiento. Modo silencioso.

MODELO	CÓDIGO	POTENCIA	SEER / SCOP	CABLE ALIM.	Ø GAS / LÍQUIDO	DIMENSIONES	PVR*
GMV5 CDTV 22	3IGR1048	2.2 / 2.5 kW	-	2 × 1,5 + T	3/8" - 1/4"	700 / 615 / 200	<b>1.076 €</b>
GMV5 CDTV 28	3IGR1049	2.8 / 3.2 kW	-	2 × 1,5 + T	3/8" - 1/4"	700 / 615 / 200	<b>1.127 €</b>
GMV5 CDTV 36	3IGR1050	3.6 / 4.0 kW	-	2 × 1,5 + T	3/8" - 1/4"	700 / 615 / 200	<b>1.160 €</b>
GMV5 CDTV 45	3IGR1051	4.5 / 5.0 kW	-	2 × 1,5 + T	3/8" - 1/4"	900 / 615 / 200	<b>1.301 €</b>
GMV5 CDTV 56	3IGR1052	5.6 / 6.3 kW	-	2 × 1,5 + T	3/8" - 1/4"	1100 / 615 / 200	<b>1.396 €</b>
GMV5 CDTV 63	3IGR1053	6.3 / 7.1 kW	-	2 × 1,5 + T	3/8" - 1/4"	1100 / 615 / 200	<b>1.434 €</b>
GMV5 CDTV 71	3IGR1054	7.1 / 8.0 kW	-	2 × 1,5 + T	3/8" - 1/4"	1100 / 615 / 200	<b>1.577 €</b>





## CONDUCTOS DE RENOVACIÓN DE AIRE

UNIDADES INTERIORES GMV



Control WiFi opcional. Modo ahorro de energía. Modo fuera de casa. Modo automático. Modo sleep. I Feel opcional. Alta eficiencia. Auto clean X-Fan. Alta presión estática. Control centralizado opcional. Control de pared. Control paro/marcha opcional. Control por cable (maestro/esclavo). Control remoto led opcional. Direccionamiento automático. Facilidad de mantenimiento. Motor de alto rendimiento. Modo silencioso.

MODELO	CÓDIGO	POTENCIA	SEER / SCOP	CABLE ALIM.	Ø GAS / LÍQUIDO	DIMENSIONES	PVR*
GMV5 AIRE 125X12	3IGR1206	12.5 / 8.5 kW	-	2 x 1,5 + T	5/8" - 3/8"	1400 / 300 / 700	<b>1.855 €</b>
GMV5 AIRE 140X12	3IGR1207	14 / 10 kW	-	2 x 1,5 + T	5/8" - 3/8"	1400 / 300 / 700	<b>1.979 €</b>
GMV5 AIRE 224X20	3IGR1208	22.4 / 16 kW	-	2 x 1,5 + T	3/4" - 3/8"	1483 / 385 / 791	<b>3.456 €</b>
GMV5 AIRE 250X25	3IGR1209	25 / 18 kW	-	2 x 1,5 + T	7/8" - 3/8"	1483 / 385 / 791	<b>3.811 €</b>
GMV5 AIRE 280X25	3IGR1210	28 / 20 kW	-	2 x 1,5 + T	7/8" - 3/8"	1483 / 385 / 791	<b>3.972 €</b>
GMV5 AIRE 450X40	3IGR1205	45 / 32 kW	-	2 x 1,5 + T	1-1/8" - 1/2"	1700 / 650 / 1100	<b>4.252 €</b>



## CASSETTE 360°

UNIDADES INTERIORES GMV



Control WiFi opcional. Aire 3D. Modo ahorro de energía. Modo fuera de casa. Modo automático. Modo sleep. I Feel. Alta eficiencia. Auto clean X-Fan. Bomba de drenaje incorporada. Control centralizado opcional. Control de pared opcional. Control paro/marcha opcional. Control por cable (maestro/esclavo) opcional. Control remoto led. Direccionamiento automático. Facilidad de mantenimiento. Motor de alto rendimiento. Modo silencioso.

### CASSETTES 600x600

MODELO	CÓDIGO	POTENCIA	SEER / SCOP	CABLE ALIM.	Ø GAS / LÍQUIDO	DIMENSIONES	PVR*
GMV5 CST 360 15C	3IGR2029K	1.5 / 1.8 kW	-	2 x 1,5 + T	3/8" - 1/4"	570 / 265 / 570	<b>1.151 €</b>
GMV5 CST 360 22C	3IGR2030K	2.2 / 2.5 kW	-	2 x 1,5 + T	3/8" - 1/4"	570 / 265 / 570	<b>1.179 €</b>
GMV5 CST 360 28C	3IGR2031K	2.8 / 3.2 kW	-	2 x 1,5 + T	3/8" - 1/4"	570 / 265 / 570	<b>1.207 €</b>
GMV5 CST 360 36C	3IGR2032K	3.6 / 4 kW	-	2 x 1,5 + T	1/2" - 1/4"	570 / 265 / 570	<b>1.279 €</b>
GMV5 CST 360 45C	3IGR2033K	4.5 / 5 kW	-	2 x 1,5 + T	1/2" - 1/4"	570 / 265 / 570	<b>1.329 €</b>
GMV5 CST 360 50C	3IGR2034K	5 / 5.6 kW	-	2 x 1,5 + T	1/2" - 1/4"	570 / 265 / 570	<b>1.363 €</b>
GMV5 CST 360 56C	3IGR2035K	5.6 / 6.3 kW	-	2 x 1,5 + T	5/8" - 3/8"	570 / 265 / 570	<b>1.424 €</b>

### CASSETTES 900x900

MODELO	CÓDIGO	POTENCIA	SEER / SCOP	CABLE ALIM.	Ø GAS / LÍQUIDO	DIMENSIONES	PVR*
GMV5 CST 360 63	3IGR2041K	6.3 / 7.1 kW	-	2 x 1,5 + T	5/8" - 3/8"	840 / 240 / 840	<b>1.590 €</b>
GMV5 CST 360 71	3IGR2042K	7.1 / 8 kW	-	2 x 1,5 + T	5/8" - 3/8"	840 / 240 / 840	<b>1.630 €</b>
GMV5 CST 360 80	3IGR2043K	8 / 9 kW	-	2 x 1,5 + T	5/8" - 3/8"	840 / 240 / 840	<b>1.728 €</b>
GMV5 CST 360 90	3IGR2044K	9 / 10 kW	-	2 x 1,5 + T	5/8" - 3/8"	840 / 240 / 840	<b>1.741 €</b>
GMV5 CST 360 100	3IGR2045K	10 / 11.2 kW	-	2 x 1,5 + T	5/8" - 3/8"	840 / 240 / 840	<b>1.809 €</b>
GMV5 CST 360 112	3IGR2046K	11.2 / 12.5 kW	-	2 x 1,5 + T	5/8" - 3/8"	840 / 240 / 840	<b>1.872 €</b>
GMV5 CST 360 125	3IGR2047K	12.5 / 14 kW	-	2 x 1,5 + T	5/8" - 3/8"	840 / 240 / 840	<b>1.948 €</b>
GMV5 CST 360 140	3IGR2048K	14 / 16 kW	-	2 x 1,5 + T	5/8" - 3/8"	840 / 240 / 840	<b>2.144 €</b>





## CASSETTE 1 Y 2 VÍAS

UNIDADES INTERIORES GMV



Control WiFi opcional. Modo ahorro de energía. Modo fuera de casa. Modo automático. Modo sleep. I Feel. Alta eficiencia. Auto clean X-Fan. Bomba de drenaje incorporada. Control centralizado opcional. Control de pared opcional. Control paro/marcha opcional. Control por cable (maestro/esclavo) opcional. Control remoto led. Direccionamiento automático. Facilidad de mantenimiento. Motor de alto rendimiento. Modo silencioso.

### CASSETTES 2 VÍAS

MODELO	CÓDIGO	POTENCIA	SEER / SCOP	CABLE ALIM.	Ø GAS / LÍQUIDO	DIMENSIONES	PVR*
GMV5 CST 28V2 B-T	3IGR2207K	2.8 / 3.2 kW	-	2 × 1,5 + T	3/8" - 1/4"	790 / 280 / 630	1.755 €
GMV5 CST 36V2 B-T	3IGR2208K	3.6 / 4 kW	-	2 × 1,5 + T	1/2" - 1/4"	790 / 280 / 630	1.769 €
GMV5 CST 45V2 B-T	3IGR2209K	4.5 / 5 kW	-	2 × 1,5 + T	1/2" - 1/4"	790 / 280 / 630	1.781 €
GMV5 CST 50V2 B-T	3IGR2210K	5 / 5.6 kW	-	2 × 1,5 + T	1/2" - 1/4"	790 / 280 / 630	1.803 €
GMV5 CST 56V2 B-T	3IGR2211K	5.6 / 6.3 kW	-	2 × 1,5 + T	5/8" - 3/8"	790 / 280 / 630	1.880 €
GMV5 CST 63V2 B-T	3IGR2212K	6.3 / 7.1 kW	-	2 × 1,5 + T	5/8" - 3/8"	790 / 280 / 630	1.897 €
GMV5 CST 71V2 B-T	3IGR2213K	7.1 / 8 kW	-	2 × 1,5 + T	5/8" - 3/8"	790 / 280 / 630	1.906 €
GMV5 CST 80V2 B-T	3IGR2214K	8 / 9 kW	-	2 × 1,5 + T	5/8" - 3/8"	790 / 280 / 630	1.990 €

### CASSETTES 1 VÍA

MODELO	CÓDIGO	POTENCIA	SEER / SCOP	CABLE ALIM.	Ø GAS / LÍQUIDO	DIMENSIONES	PVR*
GMV5 CST 22V1	3IGR2100K	2.2 / 2.5 kW	-	2 × 1,5 + T	3/8" - 1/4"	987 / 178 / 385	855 €
GMV5 CST 28V1	3IGR2101K	2.8 / 3.2 kW	-	2 × 1,5 + T	3/8" - 1/4"	987 / 178 / 385	881 €
GMV5 CST 36V1	3IGR2102K	3.6 / 4 kW	-	2 × 1,5 + T	1/2" - 1/4"	987 / 178 / 385	906 €
GMV5 CST 45V1	3IGR2103K	4.5 / 5 kW	-	2 × 1,5 + T	1/2" - 1/4"	987 / 178 / 385	950 €
GMV5 CST 50V1	3IGR2104K	5 / 5.6 kW	-	2 × 1,5 + T	1/2" - 1/4"	987 / 178 / 385	976 €



## MURAL DESIGN

UNIDADES INTERIORES GMV



Control WiFi opcional. Swing horizontal. Modo ahorro de energía. Modo fuera de casa. Modo automático. Modo sleep. I Feel. Alta eficiencia. Auto clean X-Fan. Control centralizado opcional. Control de pared opcional. Control paro/marcha opcional. Control por cable (maestro/esclavo) opcional. Control remoto led. Direccionamiento automático. Facilidad de mantenimiento. Motor de alto rendimiento. Modo silencioso.

MODELO	CÓDIGO	POTENCIA	SEER / SCOP	CABLE ALIM.	Ø GAS / LÍQUIDO	DIMENSIONES	PVR*
GMV5 M DESIGN 15	3IGR4017	1.5 / 1.8 kW	-	2 × 1,5 + T	3/8" - 1/4"	845 / 289 / 209	730 €
GMV5 M DESIGN 22	3IGR4008	2.2 / 2.5 kW	-	2 × 1,5 + T	3/8" - 1/4"	845 / 289 / 209	774 €
GMV5 M DESIGN 28	3IGR4009	2.8 / 3.2 kW	-	2 × 1,5 + T	3/8" - 1/4"	845 / 289 / 209	834 €
GMV5 M DESIGN 36	3IGR4010	3.6 / 4 kW	-	2 × 1,5 + T	1/2" - 1/4"	845 / 289 / 209	857 €
GMV5 M DESIGN 45	3IGR4011	4.5 / 5 kW	-	2 × 1,5 + T	1/2" - 1/4"	970 / 300 / 224	955 €
GMV5 M DESIGN 50	3IGR4012	5 / 5.6 kW	-	2 × 1,5 + T	1/2" - 1/4"	970 / 300 / 224	993 €
GMV5 M DESIGN 56	3IGR4013	5.6 / 6.3 kW	-	2 × 1,5 + T	5/8" - 3/8"	1078 / 325 / 246	1.079 €
GMV5 M DESIGN 63	3IGR4014	6.3 / 7.1 kW	-	2 × 1,5 + T	5/8" - 3/8"	1078 / 325 / 246	1.170 €
GMV5 M DESIGN 71	3IGR4015	7.1 / 7.5 kW	-	2 × 1,5 + T	5/8" - 3/8"	1078 / 325 / 246	1.245 €



NUEVO



## SUELO/TECHO

### UNIDADES INTERIORES GMV



Control WiFi opcional. Modo ahorro de energía. Modo fuera de casa. Modo automático. Modo sleep. I Feel. Alta eficiencia. Auto clean X-Fan. Control centralizado opcional. Control de pared opcional. Control paro/marcha opcional. Control por cable (maestro/esclavo) opcional. Control remoto led. Direccionamiento automático. Facilidad de mantenimiento. Motor de alto rendimiento. Modo silencioso.

MODELO	CÓDIGO	POTENCIA	SEER / SCOP	CABLE ALIM.	Ø GAS / LÍQUIDO	DIMENSIONES	PVR*
GMV5 ST 28 B-T	3IGR3009	2.8 / 3.2 kW	-	2 × 1,5 + T	3/8" - 1/4"	870 / 235 / 665	1.240 €
GMV5 ST 36 B-T	3IGR3010	3.6 / 4 kW	-	2 × 1,5 + T	1/2" - 1/4"	870 / 235 / 665	1.290 €
GMV5 ST 50 B-T	3IGR3011	5 / 5.6 kW	-	2 × 1,5 + T	1/2" - 1/4"	870 / 235 / 665	1.385 €
GMV5 ST 56 B-T	3IGR3012	5.6 / 6.3 kW	-	2 × 1,5 + T	5/8" - 3/8"	870 / 235 / 665	1.520 €
GMV5 ST 63 B-T	3IGR3013	6.3 / 7.1 kW	-	2 × 1,5 + T	5/8" - 3/8"	1200 / 235 / 665	1.588 €
GMV5 ST 71 B-T	3IGR3014	7.1 / 8 kW	-	2 × 1,5 + T	5/8" - 3/8"	1200 / 235 / 665	1.597 €
GMV5 ST 90 B-T	3IGR3015	9 / 10 kW	-	2 × 1,5 + T	5/8" - 3/8"	1200 / 235 / 665	1.657 €
GMV5 ST 112 B-T	3IGR3016	11.2 / 12.5 kW	-	2 × 1,5 + T	5/8" - 3/8"	1570 / 235 / 665	1.862 €
GMV5 ST 125 B-T	3IGR3017	12.5 / 14 kW	-	2 × 1,5 + T	5/8" - 3/8"	1570 / 235 / 665	1.940 €
GMV5 ST 140 B-T	3IGR3018	14 / 16 kW	-	2 × 1,5 + T	5/8" - 3/8"	1570 / 235 / 665	1.990 €
GMV5 ST 160 B-T	3IGR3019	16 / 18 kW	-	2 × 1,5 + T	3/4" - 3/8"	1570 / 235 / 665	2.050 €



## CONSOLA

### UNIDADES INTERIORES GMV



Control WiFi opcional. Modo ahorro de energía. Modo fuera de casa. Modo automático. Modo sleep. I Feel. Alta eficiencia. Auto clean X-Fan. Control centralizado opcional. Control de pared opcional. Control paro/marcha opcional. Control por cable (maestro/esclavo) opcional. Control remoto led. Direccionamiento automático. Facilidad de mantenimiento. Motor de alto rendimiento. Modo silencioso.

MODELO	CÓDIGO	POTENCIA	SEER / SCOP	CABLE ALIM.	Ø GAS / LÍQUIDO	DIMENSIONES	PVR*
GMV5 CNS 22	3IGR3100	2.2 / 2.5 kW	-	2 × 1,5 + T	3/8" - 1/4"	700 / 600 / 215	768 €
GMV5 CNS 28	3IGR3101	2.8 / 3.2 kW	-	2 × 1,5 + T	3/8" - 1/4"	700 / 600 / 215	777 €
GMV5 CNS 36	3IGR3102	3.6 / 4 kW	-	2 × 1,5 + T	3/8" - 1/4"	700 / 600 / 215	792 €
GMV5 CNS 45	3IGR3103	4.5 / 5 kW	-	2 × 1,5 + T	1/2" - 1/4"	700 / 600 / 215	801 €
GMV5 CNS 50	3IGR3104	5 / 5.5 kW	-	2 × 1,5 + T	1/2" - 1/4"	700 / 600 / 215	810 €



## COLUMNA

### UNIDADES INTERIORES GMV



Control WiFi opcional. Modo ahorro de energía. Modo fuera de casa. Modo automático. Modo sleep. I Feel. Alta eficiencia. Auto clean X-Fan. Control centralizado opcional. Control de pared opcional. Control paro/marcha opcional. Control por cable (maestro/esclavo) opcional. Control remoto led. Direccionamiento automático. Facilidad de mantenimiento. Motor de alto rendimiento. Modo silencioso.

MODELO	CÓDIGO	POTENCIA	SEER / SCOP	CABLE ALIM.	Ø GAS / LÍQUIDO	DIMENSIONES	PVR*
GMV5 S 100	3IGR3200	10 / 11 kW	-	2 × 1,5 + T	5/8" - 3/8"	580 / 1850 / 400	2.000 €
GMV5 S 140	3IGR3201	14 / 15 kW	-	2 × 1,5 + T	5/8" - 3/8"	580 / 1850 / 400	2.102 €



## KIT UTA

### UNIDADES INTERIORES GMV



Control WiFi opcional. Modo fuera de casa. Control centralizado opcional. Control de pared. Control remoto led opcional.

MODELO	CÓDIGO	POTENCIA	SEER / SCOP	CABLE ALIM.	Ø GAS / LÍQUIDO	DIMENSIONES	PVR*
GMV5 AHU 140	3IGR9000	9 - 11.2 - 14 / 10 - 12.5 - 16 kW	-	-	5/8" - 3/8"	203 / 85 / 326	702 €
GMV5 AHU 280	3IGR9001	22.4 - 28 / 25 - 31.5 kW	-	-	3/4 - 7/8" - 3/8"	203 / 85 / 326	888 €
GMV5 AHU 560	3IGR9002	45 - 50.4 - 56 / 50 - 56.5 - 62.5 kW	-	-	1 1/8" - 1/2 - 5/8"	246 / 120 / 500	1.074 €

# ENFRIADORAS



## CHILLER MODULAR INVERTER

TIPO SCROLL



Modo ahorro de energía. Cobre con estriamiento interior. Estructura modular. Facilidad de mantenimiento. Golden fin. Resistencia auxiliar. Tecnología Inverter DC. Temporizador 24h.

### SERIE R32

MODELO	CÓDIGO	POTENCIA	SEER / SCOP	CABLE ALIM.	Ø GAS / LÍQUIDO	DIMENSIONES	PVR*
SCROLLCHILL INV 32	3ICG0013	32 / 36 kW	4.19 / 3.89	-	-	1340 / 1605 / 845	<b>13.362 €</b>
SCROLLCHILL INV 60	3ICG0014	60 / 65 kW	4.6 / 3.9	-	-	2200 / 1675 / 965	<b>22.274 €</b>



**ALTA TECNOLOGÍA  
EN CLIMATIZACIÓN**

## SCROLL CHILLER MODULAR

Enfriadora de alta eficiencia compacta y versátil.

**INTERCAMBIADOR MULTITUBULAR DE ALTA EFICIENCIA**  
Resistencia aumentada, vida útil más larga.

**CONTROL DE CONDENSACIÓN**  
Enfriamiento posible hasta -15°C exteriores.

**SISTEMA MODULAR DE 32 y 60 KW CON UNIDADES EXTERIORES INDEPENDIENTES**

- Combinación máxima de hasta 1.040 kW
- Conectable a fancoils

**MÁXIMO AHORRO ENERGÉTICO**

- Gas ecológico R32
- Certificada Eurovent
- Tecnología Inverter en todos sus componentes

**EUROVENT CERTIFICADA**

**R32**

**GARANTÍA 4 AÑOS TODAS LAS PIEZAS**



# FANCOILS

NUEVO



## CONSOLAS

UNIDADES INTERIORES FANCOIL



Modo fuera de casa. Auto clean X-Fan. Ventilador multi-velocidad. Cobre con estriamiento interior. Control de pared opcional. Control remoto led. Diseño compacto. Modo silencioso.

MODELO	CÓDIGO	POTENCIA	SEER / SCOP	CABLE ALIM.	Ø CONEXIONES	DIMENSIONES	PVR*
FANCOIL CDT VT 11	3IGR7208	2,0 / 1,40 kW	-	3 × 1,5 + T	3/4 (20)	895 / 680 / 230	<b>780 €</b>
FANCOIL CDT VT 17	3IGR7209	2,3 / 1,90 kW	-	3 × 1,5 + T	3/4 (20)	895 / 680 / 230	<b>820 €</b>
FANCOIL CDT VT 26	3IGR7210	3,4 / 2,80 kW	-	3 × 1,5 + T	3/4 (20)	1050 / 680 / 230	<b>850 €</b>
FANCOIL CDT VT 33	3IGR7211	3,8 / 3,20 kW	-	3 × 1,5 + T	3/4 (20)	1050 / 680 / 230	<b>880 €</b>
FANCOIL CDT VT 42	3IGR7212	4,9 / 4,25 kW	-	3 × 1,5 + T	3/4 (20)	1050 / 680 / 230	<b>895 €</b>
FANCOIL CDT VT 52	3IGR7213	5,9 / 5,00 kW	-	3 × 1,5 + T	3/4 (20)	1350 / 680 / 230	<b>910 €</b>
FANCOIL CDT VT 58	3IGR7214	6,4 / 5,30 kW	-	3 × 1,5 + T	3/4 (20)	1350 / 680 / 230	<b>940 €</b>
FANCOIL CDT VT 63	3IGR7215	6,7 / 5,80 kW	-	3 × 1,5 + T	3/4 (20)	1350 / 680 / 230	<b>980 €</b>
FANCOIL CDT VT 72	3IGR7216	10,7 / 9,20 kW	-	3 × 1,5 + T	3/4 (20)	1773 / 680 / 230	<b>1.010 €</b>
FANCOIL CDT VT 81	3IGR7217	11,50 / 10,10 kW	-	3 × 1,5 + T	3/4 (20)	1773 / 680 / 230	<b>1.115 €</b>



## CONDUCTOS

UNIDADES INTERIORES FANCOIL



Modo fuera de casa opcional. Ventilador multi-velocidad. Cobre con estriamiento interior. Control de pared opcional. Control remoto led opcional. Diseño compacto.

### CONDUCTOS 2 TUBOS

MODELO	CÓDIGO	POTENCIA	SEER / SCOP	CABLE ALIM.	Ø CONEXIONES	DIMENSIONES	PVR*
FANCOIL CDT 20	3IGR7063	2.00 / 2.30 kW	-	3 × 1,5 + T	3/4 (20)	680 / 235 / 500	<b>285 €</b>
FANCOIL CDT 31	3IGR7064	3.10 / 3.50 kW	-	3 × 1,5 + T	3/4 (20)	800 / 235 / 500	<b>353 €</b>
FANCOIL CDT 33	3IGR7072	3.30 / 3.80 kW	-	3 × 1,5 + T	3/4 (20)	800 / 235 / 500	<b>391 €</b>
FANCOIL CDT 42	3IGR7073	4.20 / 5.10 kW	-	3 × 1,5 + T	3/4 (20)	900 / 235 / 500	<b>451 €</b>
FANCOIL CDT 54	3IGR7067	5.20 / 6.30 kW	-	3 × 1,5 + T	3/4 (20)	1080 / 235 / 500	<b>471 €</b>
FANCOIL CDT 62	3IGR7075	6.20 / 6.90 kW	-	3 × 1,5 + T	3/4 (20)	1080 / 235 / 500	<b>533 €</b>
FANCOIL CDT 69	3IGR7068	6.90 / 8.20 kW	-	3 × 1,5 + T	3/4 (20)	1380 / 235 / 500	<b>635 €</b>
FANCOIL CDT 78	3IGR7076	7.80 / 9 kW	-	3 × 1,5 + T	3/4 (20)	1380 / 235 / 500	<b>729 €</b>
FANCOIL CDT 86	3IGR7069	7.20 / 9.20 kW	-	3 × 1,5 + T	3/4 (20)	1520 / 235 / 500	<b>735 €</b>
FANCOIL CDT 102	3IGR7070	10.20 / 12 kW	-	3 × 1,5 + T	3/4 (20)	1620 / 235 / 500	<b>766 €</b>
FANCOIL CDT 105	3IGR7078	10.50 / 12.40 kW	-	3 × 1,5 + T	3/4 (20)	1620 / 235 / 500	<b>788 €</b>

### CONDUCTOS 4 TUBOS

MODELO	CÓDIGO	POTENCIA	SEER / SCOP	CABLE ALIM.	Ø CONEXIONES	DIMENSIONES	PVR*
FANCOIL CDT 23 3+1	3IGR7079	2.45 / 3.4 kW	-	3 × 1,5 + T	3/4 (20)	881 / 245 / 510	<b>435 €</b>
FANCOIL CDT 36 3+1	3IGR7080	3.7 / 4.7 kW	-	3 × 1,5 + T	3/4 (20)	1011 / 245 / 510	<b>510 €</b>
FANCOIL CDT 43 3+1	3IGR7081	4.55 / 5.7 kW	-	3 × 1,5 + T	3/4 (20)	1131 / 245 / 510	<b>584 €</b>
FANCOIL CDT 54 3+1	3IGR7082	5.4 / 6.35 kW	-	3 × 1,5 + T	3/4 (20)	1211 / 245 / 510	<b>605 €</b>
FANCOIL CDT 67 3+1	3IGR7083	6.35 / 7.55 kW	-	3 × 1,5 + T	3/4 (20)	1371 / 245 / 510	<b>613 €</b>
FANCOIL CDT 81 3+1	3IGR7084	8.3 / 9.9 kW	-	3 × 1,5 + T	3/4 (20)	1761 / 245 / 510	<b>880 €</b>
FANCOIL CDT 103 3+1	3IGR7085	10 / 11.5 kW	-	3 × 1,5 + T	3/4 (20)	1921 / 245 / 510	<b>1.016 €</b>
FANCOIL CDT 110 3+1	3IGR7086	10.2 / 11.9 kW	-	3 × 1,5 + T	3/4 (20)	1921 / 245 / 510	<b>1.056 €</b>

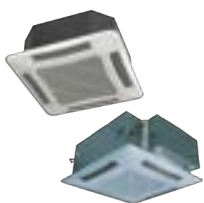

## CASSETTE

### UNIDADES INTERIORES FANCOIL



Modo fuera de casa. Auto clean X-Fan. Función pre-calefacción. Ventilador multi-velocidad. Bomba de drenaje incorporada. Cobre con estriamiento interior. Control de pared opcional. Control remoto led. Diseño compacto. Modo silencioso.

### CASSETTES 2 TUBOS

MODELO	CÓDIGO	POTENCIA	SEER / SCOP	CABLE ALIM.	Ø CONEXIONES	DIMENSIONES	PVR*
FANCOIL CST 2C30V4	3IGR7115K	2.75 / 3.40 kW	-	3 × 1,5 + T	3/4 (20)	600 / 600 / 230	706 €
FANCOIL CST 2C35V4	3IGR7116K	3.3 / 3.80 kW	-	3 × 1,5 + T	3/4 (20)	600 / 600 / 230	771 €
FANCOIL CST 2C45V4	3IGR7106K	4.5 / 5.40 kW	-	3 × 1,5 + T	3/4 (20)	840 / 840 / 190	795 €
FANCOIL CST 2C50V4	3IGR7107K	5 / 6.10 kW	-	3 × 1,5 + T	3/4 (20)	840 / 840 / 190	835 €
FANCOIL CST 2C60V4	3IGR7108K	6 / 6.90 kW	-	3 × 1,5 + T	3/4 (20)	840 / 840 / 240	850 €
FANCOIL CST 2C80V4	3IGR7109K	7.40 / 8.40 kW	-	3 × 1,5 + T	3/4 (20)	840 / 840 / 240	930 €
FANCOIL CST 2C87V4	3IGR7110K	8.40 / 9.00 kW	-	3 × 1,5 + T	3/4 (20)	840 / 840 / 240	971 €
FANCOIL CST 2C95V4	3IGR7111K	9.5 / 10.50 kW	-	3 × 1,5 + T	3/4 (20)	840 / 840 / 320	990 €
FANCOIL CST 2C130V4	3IGR7112K	11.1 / 11.70 kW	-	3 × 1,5 + T	3/4 (20)	840 / 840 / 320	1.150 €

### CASSETTES 4 TUBOS

MODELO	CÓDIGO	POTENCIA	SEER / SCOP	CABLE ALIM.	Ø CONEXIONES	DIMENSIONES	PVR*
FANCOIL CST 4C35	3IGR7100K	3.5 / 5.8 kW	-	3 × 1,5 + T	3/4 (20)	840 / 840 / 190	913 €
FANCOIL CST 4C41	3IGR7101K	4.5 / 6.8 kW	-	3 × 1,5 + T	3/4 (20)	840 / 840 / 190	952 €
FANCOIL CST 4C60	3IGR7102K	6 / 9.2 kW	-	3 × 1,5 + T	3/4 (20)	840 / 840 / 240	1.028 €
FANCOIL CST 4C80	3IGR7103K	8 / 12 kW	-	3 × 1,5 + T	3/4 (20)	840 / 840 / 320	1.178 €



## MURAL

### UNIDADES INTERIORES FANCOIL



Modo fuera de casa. Auto clean X-Fan. Función pre-calefacción. Ventilador multi-velocidad. Cobre con estriamiento interior. Control de pared opcional. Control remoto led. Diseño compacto. Modo silencioso.

MODELO	CÓDIGO	POTENCIA	SEER / SCOP	CABLE ALIM.	Ø CONEXIONES	DIMENSIONES	PVR*
FANCOIL M 20	3IGR7300	2 / 2.3 kW	-	3 × 1,5 + T	1/2 (15)	845 / 275 / 180	353 €
FANCOIL M 25	3IGR7301	2.3 / 2.8 kW	-	3 × 1,5 + T	1/2 (15)	845 / 275 / 180	379 €
FANCOIL M 36	3IGR7302	3.6 / 4.1 kW	-	3 × 1,5 + T	1/2 (15)	940 / 298 / 200	410 €
FANCOIL M 42	3IGR7303	4 / 4.5 kW	-	3 × 1,5 + T	1/2 (15)	940 / 298 / 200	451 €



## SUELO/TECHO









### UNIDADES INTERIORES FANCOIL



Modo fuera de casa. Auto clean X-Fan. Función pre-calefacción. Ventilador multi-velocidad. Cobre con estriamiento interior. Control de pared opcional. Control remoto led. Diseño compacto. Modo silencioso.

MODELO	CÓDIGO	POTENCIA	SEER / SCOP	CABLE ALIM.	Ø CONEXIONES	DIMENSIONES	PVR*
FANCOIL ST 20	3IGR7200	1.9 / 2.4 kW	-	3 × 1,5 + T	3/4 (20)	834 / 694 / 238	531 €
FANCOIL ST 28	3IGR7201	2.80 / 3.4 kW	-	3 × 1,5 + T	3/4 (20)	834 / 694 / 238	544 €
FANCOIL ST 36	3IGR7202	3.5 / 4.10 kW	-	3 × 1,5 + T	3/4 (20)	834 / 694 / 238	568 €
FANCOIL ST 42	3IGR7203	3.6 / 4.2 kW	-	3 × 1,5 + T	3/4 (20)	834 / 694 / 238	597 €
FANCOIL ST 54	3IGR7204	5.2 / 6 kW	-	3 × 1,5 + T	3/4 (20)	1300 / 600 / 188	727 €
FANCOIL ST 63	3IGR7205	6.35 / 6.7 kW	-	3 × 1,5 + T	3/4 (20)	1300 / 600 / 188	748 €
FANCOIL ST 89	3IGR7206	8.9 / 10.8 kW	-	3 × 1,5 + T	3/4 (20)	1590 / 695 / 238	994 €
FANCOIL ST 99	3IGR7207	9.9 / 12.2 kW	-	3 × 1,5 + T	3/4 (20)	1590 / 695 / 238	1.028 €

# DOMÉSTICO







ACCESORIOS			SERIE	PORTÁTILES	MONOSPLITS	MONOSPLITS & MULTISPLITS FREE MATCH				MULTISPLITS FREE MATCH		
				SHINY	MUSE	U-CROWN	FAIR	PULAR	CONSOLA	CONDUCTOS	CASSETTE	SUELO/TECHO
Control por cable	3IGR9022	48 €								●	●	●
	3NGR9020	187 €					●	●	●	●	●	●
Control paro/marcha	3NGR9022	34 €					●	●				
Control centralizado	3NGR9028 (AD)	695 €					●	●	●	●	●	●
Wifi 18-24K	3NGR9039	50 €			●		●	●	●			
Kit de ventana	3NGR9008	29 €		●								
2 Filtros Catequina	3NGR9047	862 €			●	●	●	●				
2 Filtros PM2.5 + Iones de plata	3NGR9048	1.220 €			●	●	●	●				
2 Filtros PM2.5 + Catequina	3NGR9049	1.242 €			●	●	●	●				

- De serie
- Opcional

\*Los filtros de purificación se venden en lotes de 50 con un expositor.

# COMERCIAL

ACCESORIOS			SERIE	MONOSPLITS U-MATCH		
				CONDUCTOS	CASSETTE	SUELO/TECHO
Control inalámbrico	3NGR9036	30 €		●	●	●
Control por cable	3NGR9040	145 €		●	●	●
Interfaz Modbus	3NGR9034	31 €		●	●	●
Modulo de contacto seco	3NGR9035	215 €		●	●	●
Control paro/marcha	3NGR9007	22 €		●	●	●
Wifi G-Cloud	3NGR9032	73 €			●	
	3NGR9033	53 €		●	●	●

















ACCESORIOS			SERIE	MONOSPLITS U-MATCH		
				CONDUCTOS	CASSETTE	SUELO/TECHO
Kit renovación de aire	3NGR9037	250 €			●	
Control centralizado	3NGR9028 (UM)	695 €		●	●	●
Kit Multi	3NGR9051	202 €		●	●	●
	3NGR9055	95 €		●	●	●
	3NGR9056	105 €		●	●	●
	3NGR9057	135 €		●	●	●

- De serie
- Opcional

## BIG DUCT

ACCESORIOS			SERIE	CONDUCTOS DE ALTA CAPACIDAD
				BIG DUCT
Control inalámbrico	3IGR9100	24 €		●
Receptor infrarrojos	3IGR9019	80 €		●
Control paro/marcha	3IGR9135	145 €		●
	3IGR9021	50 €		●
Control centralizado	3IGR9106 (BD)	1.150 €		●
Módulo multi-función Modbus RTU	3NGR9050	1.368 €		●

- De serie
- Opcional

ACCESORIOS			SERIE	UNIDADES INTERIORES GMV										
				CONDUCTOS LIGEROS 1.5	CONDUCTOS	CONDUCTOS DE RENOVACIÓN DE AIRE	CASSETTE 360°	CASSETTE 1 Y 2 VÍAS	MURAL DESIGN	SUELO/TECHO	CONSOLA	CONDUCTOS VERTICALES	COLUMNA	KIT UTA
Control inalámbrico	3IGR9100	24 €		●	●	●	●	●	●	●	●	●	●	
	3IGR9101	27 €		●	●	●	●	●	●	●	●	●	●	
Receptor infrarrojos	3IGR9019	80 €		●	●	●						●		
Kit renovación de aire	3NGR9037	250 €					●							
Control por cable	3IGR9102	110 €		●	●	●	●	●	●	●	●	●	●	●
	3IGR9020	120 €		●	●	●	●	●	●	●	●	●	●	
Control paro/marcha	3IGR9135	145 €		●	●	●	●	●	●	●	●	●	●	
	3IGR9021	50 €		●	●	●	●	●	●	●	●	●	●	
Control centralizado	3IGR9106 (GMV)	1.150 €		●	●	●	●	●	●	●	●	●	●	●
	3IGR9107	1.355 €		●	●	●	●	●	●	●	●	●	●	●
	3IGR9108	555 €		●	●	●	●	●	●	●	●	●	●	●
Software de gestión remota	3IGR9140	1.973 €		●	●	●	●	●	●	●	●	●	●	
Software de gestión energética	3IGR9151	550 €		●	●	●	●	●	●	●	●	●	●	
Modulo de gestión energética y remota	3IGR9152	1.150 €		●	●	●	●	●	●	●	●	●	●	
Interfaz Modbus / BACnet	3IGR9153	1.250 €		●	●	●	●	●	●	●	●	●	●	
Interfaz Modbus RTU	3IGR9143	1.450 €		●	●	●	●	●	●	●	●	●	●	
Wifi G-Cloud	3IGR9116	105 €		●	●	●	●	●	●	●	●	●	●	

● De serie  
● Opcional







## COLECTORES Y SEPARADORES

	CÓDIGO	REFERENCIA	GMV5 MINI	GMV5 SLIM	GMV6	GMV5 HR	GMV6 HR	GMV5 HOME	GMV5 SOLAR	PVR*
SEPARADORES	3IGR9525	FQ01A/A	●	●	●			●	●	82 €
	3IGR9526	FQ01B/A	●	●	●			●	●	82 €
	3IGR9527	FQ02A	●	●	●			●	●	225 €
	3IGR9528	FQ03A	●	●	●			●	●	270 €
	3IGR9529	FQ04A	●	●	●			●	●	685 €
	3IGR9518	FQ01Na/A				●	●			105 €
	3IGR9519	FQ02Na/A				●	●			120 €
	3IGR9520	FQ03Na/A				●	●			185 €
	3IGR9521	FQ04Na/A				●	●			270 €
	3IGR9522	FQ05Na/A				●	●			360 €
	3IGR9523	FQ06Na/A				●	●			450 €
	3IGR9524	FQ07Na/A				●	●			805 €
	3IGR9514	ML01/A			●					585 €
	3IGR9507	ML01R				●	●			755 €
COLECTORES	3IGR9515	FQ14/H1	●	●	●			●	●	205 €
	3IGR9516	FQ18/H1	●	●	●			●	●	322 €
	3IGR9517	FQ18/H2	●	●	●			●	●	345 €

## ENFRIADORAS

ACCESORIOS			SERIE	ENFRIADORAS
				CHILLER MODULAR INVERTER
Control por cable	3IGR9139	454 €		●

## FANCOILS

ACCESORIOS			SERIE	FANCOILS			
				CONDUCTOS	CASSETTE	MURAL	SUELO/TECHO
Electronica + control	3IGR9136	255 €		●			
Control por cable	3IGR9126	55 €			●	●	●
Termostato digital	3IGR9144	80 €		●			
Control inalámbrico	3IGR9137	303 €		●			
Interfaz Modbus	3IGR9127	351 €			●	●	●

## KIT DE VÁLVULAS

MODELO	CÓDIGO	VÍAS	PVR*
FANCOIL V 2V 1/2	3IGR9600	2	105 €
FANCOIL V 2V 3/4	3IGR9601	2	120 €
FANCOIL V 2V 1	3IGR9602	2	130 €
FANCOIL V 3V 1/2	3IGR9603	3	165 €
FANCOIL V 3V 3/4	3IGR9604	3	175 €
FANCOIL V 3V 1	3IGR9605	3	185 €

# COMBINACIONES DE UNIDADES INTERIORES FREE MATCH

## 8 COMBINACIONES



		2 UNIDADES	
FM 14	7	7+7	9+9
	9	7+9	9+12
	12	7+12	

## 8 COMBINACIONES



		2 UNIDADES	
FM 18		7+7	9+9
	9	7+9	9+12
	12	7+12	12+12

## 17 COMBINACIONES



		2 UNIDADES		3 UNIDADES	
FM 21	7+7	9+12	7+7+7	7+9+12	
	7+9	9+18	7+7+9	7+12+12	
	7+12	12+12	7+7+12	9+9+9	
	7+18	12+18	7+9+9	9+9+12	
	9+9	-	-	-	

## 23 COMBINACIONES



		2 UNIDADES		3 UNIDADES	
FM 24	7+7	9+12	7+7+7	7+12+12	
	7+9	9+18	7+7+9	9+9+9	
	7+12	12+12	7+7+12	9+9+12	
	7+18	12+18	7+7+18	9+9+18	
	9+9	18+18	7+9+9	9+12+12	
	-	-	7+9+12	12+12+12	
	-	-	7+9+18	-	

## 40 COMBINACIONES



		2 UNIDADES		3 UNIDADES		4 UNIDADES	
FM 28	7+7	9+12	7+7+7	7+12+18	7+7+7+7	7+7+12+12	
	7+9	9+18	7+7+9	9+9+9	7+7+7+9	7+9+9+9	
	7+12	12+12	7+7+12	9+9+12	7+7+7+12	7+9+9+12	
	7+18	12+18	7+7+18	9+9+18	7+7+7+18	7+9+12+12	
	9+9	18+18	7+9+9	9+12+12	7+7+9+9	9+9+9+9	
	-	-	7+9+12	9+12+18	7+7+9+12	9+9+9+12	
	-	-	7+9+18	12+12+12	7+7+9+18	9+9+12+12	
	-	-	7+12+12	12+12+18	-	-	

## 107 COMBINACIONES



		2 UNIDADES		3 UNIDADES			4 UNIDADES		
FM 36	7+12	18+24	7+7+7	7+18+18	9+18+21	7+7+7+7	7+7+18+18	9+9+9+9	
	7+18	21+21	7+7+9	7+18+21	9+18+24	7+7+7+9	7+7+18+21	9+9+9+12	
	7+21	21+24	7+7+12	7+18+24	9+21+21	7+7+7+12	7+9+9+9	9+9+9+18	
	7+24	24+24	7+7+18	7+21+21	9+21+24	7+7+7+18	7+9+9+12	9+9+9+21	
	9+9	-	7+7+21	7+21+24	12+12+12	7+7+7+21	7+9+9+18	9+9+9+24	
	9+12	-	7+7+24	9+9+9	12+12+18	7+7+7+24	7+9+9+21	9+9+12+12	
	9+18	-	7+9+9	9+9+12	12+12+21	7+7+9+9	7+9+9+24	9+9+12+18	
	9+21	-	7+9+12	9+9+18	12+12+24	7+7+9+12	7+9+12+12	9+9+12+21	
	9+24	-	7+9+18	9+9+21	12+18+18	7+7+9+18	7+9+12+18	9+9+12+24	
	12+12	-	7+9+21	9+9+24	12+18+21	7+7+9+21	7+9+12+21	9+9+18+18	
	12+18	-	7+9+24	9+12+12	12+18+24	7+7+9+24	7+9+12+24	9+12+12+12	
	12+21	-	7+12+12	9+12+18	12+21+21	7+7+12+12	7+9+18+18	9+12+12+18	
	12+24	-	7+12+18	9+12+21	18+18+18	7+7+12+18	7+12+12+12	9+12+12+21	
	18+18	-	7+12+21	9+12+24	-	7+7+12+21	7+12+12+18	12+12+12+12	
	18+21	-	7+12+24	9+18+18	-	7+7+12+24	7+12+12+21	12+12+12+18	

# 208 COMBINACIONES



FM 42

2 UNID.	3 UNIDADES		4 UNIDADES			5 UNIDADES		
7 + 18	7 + 7 + 7	9 + 12 + 12	7 + 7 + 7 + 7	7 + 9 + 12 + 12	9 + 9 + 12 + 24	7 + 7 + 7 + 7 + 7	7 + 7 + 9 + 21 + 12	9 + 9 + 9 + 18 + 9
7 + 21	7 + 7 + 9	9 + 12 + 18	7 + 7 + 7 + 9	7 + 9 + 12 + 18	9 + 9 + 18 + 18	7 + 7 + 7 + 9 + 7	7 + 7 + 9 + 24 + 12	9 + 9 + 9 + 21 + 9
7 + 24	7 + 7 + 12	9 + 12 + 21	7 + 7 + 7 + 12	7 + 9 + 12 + 21	9 + 9 + 18 + 21	7 + 7 + 7 + 12 + 7	7 + 7 + 9 + 18 + 18	9 + 9 + 9 + 24 + 9
9 + 12	7 + 7 + 18	9 + 12 + 24	7 + 7 + 7 + 18	7 + 9 + 12 + 24	9 + 9 + 18 + 24	7 + 7 + 7 + 18 + 7	7 + 7 + 9 + 21 + 18	9 + 9 + 9 + 12 + 12
9 + 18	7 + 7 + 21	9 + 18 + 18	7 + 7 + 7 + 21	7 + 9 + 18 + 18	9 + 9 + 21 + 21	7 + 7 + 7 + 21 + 7	7 + 7 + 12 + 12 + 12	9 + 9 + 9 + 18 + 12
9 + 21	7 + 7 + 24	9 + 18 + 21	7 + 7 + 7 + 24	7 + 9 + 18 + 21	9 + 9 + 21 + 24	7 + 7 + 7 + 24 + 7	7 + 7 + 12 + 18 + 12	9 + 9 + 9 + 21 + 12
9 + 24	7 + 9 + 9	9 + 18 + 24	7 + 7 + 9 + 9	7 + 9 + 18 + 24	9 + 12 + 12 + 12	7 + 7 + 7 + 9 + 9	7 + 7 + 12 + 21 + 12	9 + 9 + 9 + 24 + 12
12 + 12	7 + 9 + 12	9 + 21 + 21	7 + 7 + 9 + 12	7 + 9 + 21 + 21	9 + 12 + 12 + 18	7 + 7 + 7 + 12 + 9	7 + 7 + 12 + 24 + 12	9 + 9 + 9 + 18 + 18
12 + 18	7 + 9 + 18	9 + 21 + 24	7 + 7 + 9 + 18	7 + 9 + 21 + 24	9 + 12 + 12 + 21	7 + 7 + 7 + 18 + 9	7 + 7 + 12 + 18 + 18	9 + 9 + 12 + 12 + 12
12 + 21	7 + 9 + 21	9 + 24 + 24	7 + 7 + 9 + 21	7 + 12 + 12 + 12	9 + 12 + 12 + 24	7 + 7 + 7 + 21 + 9	7 + 9 + 9 + 9 + 9	9 + 9 + 12 + 18 + 12
12 + 24	7 + 9 + 24	12 + 12 + 12	7 + 7 + 9 + 24	7 + 12 + 12 + 18	9 + 12 + 18 + 18	7 + 7 + 7 + 24 + 9	7 + 9 + 9 + 12 + 9	9 + 9 + 12 + 21 + 12
18 + 18	7 + 12 + 12	12 + 12 + 18	7 + 7 + 12 + 12	7 + 12 + 12 + 21	9 + 12 + 18 + 21	7 + 7 + 7 + 12 + 12	7 + 9 + 9 + 18 + 9	9 + 12 + 12 + 12 + 12
18 + 21	7 + 12 + 18	12 + 12 + 21	7 + 7 + 12 + 18	7 + 12 + 12 + 24	9 + 12 + 18 + 24	7 + 7 + 7 + 18 + 12	7 + 9 + 9 + 21 + 9	9 + 12 + 12 + 18 + 12
18 + 24	7 + 12 + 21	12 + 12 + 24	7 + 7 + 12 + 21	7 + 12 + 18 + 18	9 + 12 + 21 + 21	7 + 7 + 7 + 21 + 12	7 + 9 + 9 + 24 + 9	12 + 12 + 12 + 12 + 12
21 + 21	7 + 12 + 24	12 + 18 + 18	7 + 7 + 12 + 24	7 + 12 + 18 + 21	9 + 18 + 18 + 18	7 + 7 + 7 + 24 + 12	7 + 9 + 9 + 12 + 12	-
21 + 24	7 + 18 + 18	12 + 18 + 21	7 + 7 + 18 + 18	7 + 12 + 18 + 24	12 + 12 + 12 + 12	7 + 7 + 7 + 18 + 18	7 + 9 + 9 + 18 + 12	-
24 + 24	7 + 18 + 21	12 + 18 + 24	7 + 7 + 18 + 21	7 + 12 + 21 + 21	12 + 12 + 12 + 18	7 + 7 + 7 + 21 + 18	7 + 9 + 9 + 21 + 12	-
-	7 + 18 + 24	12 + 21 + 21	7 + 7 + 18 + 24	7 + 18 + 18 + 18	12 + 12 + 12 + 21	7 + 7 + 7 + 24 + 18	7 + 9 + 9 + 24 + 12	-
-	7 + 21 + 21	12 + 21 + 24	7 + 7 + 21 + 21	9 + 9 + 9 + 9	12 + 12 + 12 + 24	7 + 7 + 7 + 21 + 21	7 + 9 + 9 + 18 + 18	-
-	7 + 21 + 24	12 + 24 + 24	7 + 7 + 21 + 24	9 + 9 + 9 + 12	12 + 12 + 18 + 18	7 + 7 + 9 + 9 + 9	7 + 9 + 12 + 12 + 12	-
-	7 + 24 + 24	18 + 18 + 18	7 + 7 + 24 + 24	9 + 9 + 9 + 18	12 + 12 + 18 + 21	7 + 7 + 9 + 12 + 9	7 + 9 + 12 + 18 + 12	-
-	9 + 9 + 9	18 + 18 + 21	7 + 9 + 9 + 9	9 + 9 + 9 + 21	-	7 + 7 + 9 + 18 + 9	7 + 9 + 12 + 21 + 12	-
-	9 + 9 + 12	18 + 18 + 24	7 + 9 + 9 + 12	9 + 9 + 9 + 24	-	7 + 7 + 9 + 21 + 9	7 + 12 + 12 + 12 + 12	-
-	9 + 9 + 18	18 + 21 + 21	7 + 9 + 9 + 18	9 + 9 + 12 + 12	-	7 + 7 + 9 + 24 + 9	7 + 12 + 12 + 18 + 12	-
-	9 + 9 + 21	18 + 21 + 24	7 + 9 + 9 + 21	9 + 9 + 12 + 18	-	7 + 7 + 9 + 12 + 12	9 + 9 + 9 + 9 + 9	-
-	9 + 9 + 24	21 + 21 + 21	7 + 9 + 9 + 24	9 + 9 + 12 + 21	-	7 + 7 + 9 + 18 + 12	9 + 9 + 9 + 12 + 9	-

FM 14

FRÍO									
Unidad interior conectada	Capacidad total	Unidad int. A	Unidad int. B	Unidad int. C	Unidad int. D	Unidad int. E	Potencia (min-max) W	Consumo eléctrico (min-max) W	SEER
7	7	2100					2100 (2050 - 2900)	650 (200 - 1300)	6,1
9	9	2600					2600 (2050 - 3000)	700 (200 - 1300)	6,1
12	12	3500					3500 (2050 - 4000)	1000 (300 - 1780)	6,1
7 + 7	14	2050	2050				4100 (2050 - 5000)	1100 (400 - 2250)	7,2
7 + 9	16	1794	2306				4100 (2050 - 5000)	1100 (400 - 2250)	7,2
7 + 12	19	1511	2589				4100 (2050 - 5000)	1100 (400 - 2250)	7,2
9 + 9	18	2050	2050				4100 (2050 - 5000)	1100 (400 - 2250)	7,2
9 + 12	21	1757	2343				4100 (2050 - 5000)	1100 (400 - 2250)	7,2

FM 14

CALOR									
Unidad interior conectada	Capacidad total	Unidad int. A	Unidad int. B	Unidad int. C	Unidad int. D	Unidad int. E	Potencia (min-max) W	Consumo eléctrico (min-max) W	SCOP
7	7	2600					2600 (2050 - 2808)	800 (300 - 1800)	4,0
9	9	2800					2800 (2050 - 3024)	800 (300 - 1800)	4,0
12	12	3800					3800 (2050 - 4104)	800 (400 - 2000)	4,0
7 + 7	14	2200	2200				4400 (2500 - 5400)	970 (600 - 2250)	4,2
7 + 9	16	1925	2475				4400 (2500 - 5400)	970 (600 - 2250)	4,2
7 + 12	19	1621	2779				4400 (2500 - 5400)	970 (600 - 2250)	4,2
9 + 9	18	2200	2200				4400 (2500 - 5400)	970 (600 - 2250)	4,2
9 + 12	21	1886	2514				4400 (2500 - 5400)	970 (600 - 2250)	4,2

FM 18

FRÍO									
Unidad interior conectada	Capacidad total	Unidad int. A	Unidad int. B	Unidad int. C	Unidad int. D	Unidad int. E	Potencia (min-max) W	Consumo eléctrico (min-max) W	SEER
9	9	2600					2600 (2150 - 3000)	700 (300 - 1500)	6,1
12	12	3500					3500 (2150 - 3800)	1200 (300 - 1800)	6,1
7 + 7	14	2100	2100				4200 (2150 - 4800)	1400 (400 - 2000)	7,2
7 + 9	16	2100	2600				4700 (2150 - 5200)	1440 (400 - 2000)	7,2
7 + 12	19	2100	3100				5200 (2150 - 5800)	1480 (400 - 2500)	7,2
9 + 9	18	2600	2600				5200 (2150 - 5800)	1480 (400 - 2500)	7,2
9 + 12	21	2229	2971				5200 (2150 - 5800)	1480 (500 - 2500)	7,2
12 + 12	24	2600	2600				5200 (2150 - 5800)	1480 (500 - 2500)	7,2

FM 18

CALOR									
Unidad interior conectada	Capacidad total	Unidad int. A	Unidad int. B	Unidad int. C	Unidad int. D	Unidad int. E	Potencia (min-max) W	Consumo eléctrico (min-max) W	SCOP
9	9	2800					2800 (2050 - 3024)	800 (400 - 1800)	4,0
12	12	3800					3800 (2050 - 4104)	800 (400 - 2000)	4,0
7 + 7	14	2600	2600				5200 (2050 - 5616)	1000 (500 - 2200)	4,2
7 + 9	16	2600	2800				5400 (2050 - 5832)	1100 (600 - 2200)	4,2
7 + 12	19	1989	3411				5400 (2500 - 5900)	1250 (700 - 2500)	4,2
9 + 9	18	2700	2700				5400 (2500 - 5900)	1250 (700 - 2500)	4,2
9 + 12	21	2314	3086				5400 (2500 - 5900)	1250 (700 - 2500)	4,2
12 + 12	24	2700	2700				5400 (2500 - 5900)	1250 (700 - 2500)	4,2

FM 21

FRÍO									
Unidad interior conectada	Capacidad total	Unidad int. A	Unidad int. B	Unidad int. C	Unidad int. D	Unidad int. E	Potencia (min-max) W	Consumo eléctrico (min-max) W	SEER
7 + 7	14	2100	2100				4200 (2200 - 2800)	900 (400 - 2000)	6,1
7 + 9	16	2100	2600				4700 (2200 - 3000)	1000 (400 - 2400)	6,1
7 + 12	19	2100	3500				5600 (2200 - 3800)	1200 (400 - 2600)	6,1
7 + 18	25	1708	4392				6100 (2200 - 7330)	1480 (500 - 2900)	6,1
9 + 9	18	2550	2550				5100 (2200 - 5600)	1200 (400 - 2600)	6,1
9 + 12	21	2614	3486				6100 (2200 - 7330)	1480 (500 - 2900)	6,1
9 + 18	27	2033	4067				6100 (2200 - 7330)	1480 (600 - 2900)	6,1
12 + 12	24	3050	3050				6100 (2200 - 7330)	1480 (600 - 2900)	6,1
12 + 18	30	2440	3660				6100 (2200 - 7330)	1480 (600 - 2900)	6,1
7 + 7 + 7	21	2033	2033	2033			6100 (2200 - 7330)	1480 (600 - 2900)	7,8
7 + 7 + 9	23	1857	1857	2387			6100 (2200 - 7330)	1480 (600 - 2900)	7,8
7 + 7 + 12	26	1642	1642	2815			6100 (2200 - 7330)	1480 (600 - 2900)	7,8
7 + 9 + 9	25	1708	2196	2196			6100 (2200 - 7330)	1480 (600 - 2900)	7,8
7 + 9 + 12	28	1525	1961	2614			6100 (2200 - 7330)	1480 (600 - 2900)	7,8
7 + 12 + 12	31	1377	2361	2361			6100 (2200 - 7330)	1480 (600 - 2900)	7,8
9 + 9 + 9	27	2033	2033	2033			6100 (2200 - 7330)	1480 (600 - 2900)	7,8
9 + 9 + 12	30	1830	1830	2440			6100 (2200 - 7330)	1480 (600 - 2900)	7,8

FM 21

CALOR									
Unidad interior conectada	Capacidad total	Unidad int. A	Unidad int. B	Unidad int. C	Unidad int. D	Unidad int. E	Potencia (min-max) W	Consumo eléctrico (min-max) W	SCOP
7 + 7	14	2600	2600				5200 (3600 - 8500)	950 (400 - 2200)	4,0
7 + 9	16	2600	2800				5400 (3600 - 8500)	1090 (400 - 2200)	4,0
7 + 12	19	2600	3800				6400 (3600 - 8500)	1290 (600 - 2500)	4,0
7 + 18	25	1820	4680				6500 (3600 - 8500)	1430 (800 - 2900)	4,0
9 + 9	18	2800	2800				5600 (3600 - 8500)	1230 (600 - 2500)	4,0
9 + 12	21	2700	3800				6500 (3600 - 8500)	1430 (800 - 2900)	4,0
9 + 18	27	2167	4333				6500 (3600 - 8500)	1430 (800 - 2900)	4,0
12 + 12	24	3250	3250				6500 (3600 - 8500)	1430 (800 - 2900)	4,0
12 + 18	30	2600	3900				6500 (3600 - 8500)	1430 (800 - 2900)	4,0
7 + 7 + 7	21	2167	2167	2167			6500 (3600 - 8500)	1430 (800 - 2900)	4,3
7 + 7 + 9	23	1978	1978	2543			6500 (3600 - 8500)	1430 (800 - 2900)	4,3
7 + 7 + 12	26	1750	1750	3000			6500 (3600 - 8500)	1430 (800 - 2900)	4,3
7 + 9 + 9	25	1820	2340	2340			6500 (3600 - 8500)	1430 (800 - 2900)	4,3
7 + 9 + 12	28	1625	2089	2786			6500 (3600 - 8500)	1430 (800 - 2900)	4,3
7 + 12 + 12	31	1468	2516	2516			6500 (3600 - 8500)	1430 (800 - 2900)	4,3
9 + 9 + 9	27	2167	2167	2167			6500 (3600 - 8500)	1430 (800 - 2900)	4,3
9 + 9 + 12	30	1950	1950	2600			6500 (3600 - 8500)	1430 (800 - 2900)	4,3

FM 24

FRÍO									
Unidad interior conectada	Capacidad total	Unidad int. A	Unidad int. B	Unidad int. C	Unidad int. D	Unidad int. E	Potencia (min-max) W	Consumo eléctrico (min-max) W	SEER
7 + 7	14	2100	2100				4200 (2400 - 4900)	1100 (600 - 2600)	6,1
7 + 9	16	2100	2600				4700 (2400 - 5200)	1250 (600 - 2800)	6,1
7 + 12	19	2100	3500				5600 (2400 - 6300)	1500 (800 - 3000)	6,1
7 + 18	25	1988	5112				7100 (2400 - 8500)	1880 (1000 - 3400)	6,1
9 + 9	18	2600	2600				5200 (2400 - 6300)	1400 (800 - 3000)	6,1
9 + 12	21	2600	3500				6100 (2400 - 7300)	1645 (1000 - 3200)	6,1
9 + 18	27	2367	4733				7100 (2400 - 8500)	1880 (1100 - 3400)	6,1
12 + 12	24	3550	3550				7100 (2400 - 8500)	1880 (1100 - 3400)	6,1
12 + 18	30	2840	4260				7100 (2400 - 8500)	1880 (1100 - 3400)	6,1
18 + 18	36	3550	3550				7100 (2400 - 8500)	1880 (1100 - 3400)	6,1
7 + 7 + 7	21	2100	2100	2100			6300 (2400 - 4900)	1645 (1100 - 3200)	7,1
7 + 7 + 9	23	2100	2100	2600			6800 (2400 - 8500)	1800 (1100 - 3400)	7,1
7 + 7 + 12	26	1912	1912	3277			7100 (2400 - 8500)	1880 (1100 - 3400)	7,1
7 + 7 + 18	32	1553	1553	3994			7100 (2400 - 8500)	1880 (1100 - 3400)	7,1
7 + 9 + 9	25	1988	2556	2556			7100 (2400 - 8500)	1880 (1100 - 3400)	7,1
7 + 9 + 12	28	1775	2282	3043			7100 (2400 - 8500)	1880 (1100 - 3400)	7,1
7 + 9 + 18	34	1462	1879	3759			7100 (2400 - 8500)	1880 (1100 - 3400)	7,1
7 + 12 + 12	31	1603	2748	2748			7100 (2400 - 8500)	1880 (1100 - 3400)	7,1
9 + 9 + 9	27	2367	2367	2367			7100 (2400 - 8500)	1880 (1100 - 3400)	7,1
9 + 9 + 12	30	2130	2130	2840			7100 (2400 - 8500)	1880 (1100 - 3400)	7,1
9 + 9 + 18	36	1775	1775	3550			7100 (2400 - 8500)	1880 (1100 - 3400)	7,1
9 + 12 + 12	33	1936	2582	2582			7100 (2400 - 8500)	1880 (1100 - 3400)	7,1
12 + 12 + 12	36	2367	2367	2367			7100 (2400 - 8500)	1880 (1100 - 3400)	7,1

FM 24

CALOR									
Unidad interior conectada	Capacidad total	Unidad int. A	Unidad int. B	Unidad int. C	Unidad int. D	Unidad int. E	Potencia (min-max) W	Consumo eléctrico (min-max) W	SCOP
7 + 7	14	2600	2600				5200 (3600 - 8800)	1300 (600 - 2000)	4,0
7 + 9	16	2600	2800				5400 (3600 - 8800)	1490 (600 - 2000)	4,0
7 + 12	19	2600	3800				6400 (3600 - 8800)	1770 (600 - 2400)	4,0
7 + 18	25	2600	5600				8200 (3600 - 8800)	2230 (800 - 3000)	4,0
9 + 9	18	2600	2600				5200 (3600 - 8800)	1672 (600 - 2400)	4,0
9 + 12	21	2600	3800				6400 (3600 - 8800)	1951 (600 - 2600)	4,0
9 + 18	27	2800	5600				8400 (3600 - 8800)	2230 (800 - 3000)	4,0
12 + 12	24	4250	4250				8500 (3600 - 8800)	2230 (800 - 3000)	4,0
12 + 18	30	3400	5100				8500 (3600 - 8800)	2230 (800 - 3000)	4,0
18 + 18	36	4250	4250				8500 (3600 - 8800)	2230 (800 - 3000)	4,0
7 + 7 + 7	21	2600	2600	2600			7800 (3600 - 8800)	1951 (800 - 2600)	4,3
7 + 7 + 9	23	2600	2600	2800			8000 (3600 - 8800)	2137 (800 - 2800)	4,3
7 + 7 + 12	26	2288	2288	3923			8500 (3600 - 8800)	2230 (800 - 3000)	4,3
7 + 7 + 18	32	1859	1859	4781			8500 (3600 - 8800)	2230 (800 - 3000)	4,3
7 + 9 + 9	25	2380	3060	3060			8500 (3600 - 8800)	2230 (800 - 3000)	4,3
7 + 9 + 12	28	2125	2732	3643			8500 (3600 - 8800)	2230 (800 - 3000)	4,3
7 + 9 + 18	34	1750	2250	4500			8500 (3600 - 8800)	2230 (800 - 3000)	4,3
7 + 12 + 12	31	1919	3290	3290			8500 (3600 - 8800)	2230 (800 - 3000)	4,3
9 + 9 + 9	27	2833	2833	2833			8500 (3600 - 8800)	2230 (800 - 3000)	4,3
9 + 9 + 12	30	2550	2550	3400			8500 (3600 - 8800)	2230 (800 - 3000)	4,3
9 + 9 + 18	36	2125	2125	4250			8500 (3600 - 8800)	2230 (800 - 3000)	4,3
9 + 12 + 12	33	2318	3091	3091			8500 (3600 - 8800)	2230 (800 - 3000)	4,3
12 + 12 + 12	36	2833	2833	2833			8500 (3600 - 8800)	2230 (800 - 3000)	4,3

FM 28

FRÍO									
Unidad interior conectada	Capacidad total	Unidad int. A	Unidad int. B	Unidad int. C	Unidad int. D	Unidad int. E	Potencia (min-max) W	Consumo eléctrico (min-max) W	SEER
7 + 7	14	2100	2100				4200 (2500 - 4536)	1100 (800 - 2400)	6,1
7 + 9	16	2100	2600				4700 (2500 - 5076)	1200 (800 - 2600)	6,1
7 + 12	19	2100	3500				5600 (2500 - 6048)	1440 (800 - 2600)	6,1
7 + 18	25	2100	5000				7100 (2500 - 7668)	1900 (1000 - 3000)	6,1
9 + 9	18	2600	2600				5200 (2500 - 5616)	1400 (800 - 2600)	6,1
9 + 12	21	2600	3500				6100 (2500 - 6588)	1600 (800 - 2800)	6,1
9 + 18	27	2600	5000				7600 (2500 - 8208)	2000 (1200 - 2800)	6,1
12 + 12	24	3500	3500				7000 (2500 - 7560)	1800 (1200 - 2800)	6,1
12 + 18	30	3200	4800				8000 (2500 - 10000)	2120 (1200 - 3400)	6,1
18 + 18	36	4000	4000				8000 (2500 - 10000)	2120 (1200 - 3600)	6,1
7 + 7 + 7	21	2100	2100	2100			6300 (2500 - 6804)	1600 (1200 - 2800)	6,5
7 + 7 + 9	23	2100	2100	2600			6800 (2500 - 7344)	1750 (1200 - 2800)	6,5
7 + 7 + 12	26	2100	2100	3500			7700 (2500 - 8316)	2000 (1200 - 3000)	6,5
7 + 7 + 18	32	1750	1750	4500			8000 (2500 - 10000)	2120 (1300 - 3600)	6,5
7 + 9 + 9	25	2100	2880	2880			7860 (2500 - 8488,8)	1900 (1300 - 3000)	6,5

FM 28

CALOR									
Unidad interior conectada	Capacidad total	Unidad int. A	Unidad int. B	Unidad int. C	Unidad int. D	Unidad int. E	Potencia (min-max) W	Consumo eléctrico (min-max) W	SCOP
7 + 7	14	2600	2600				5200 (3600 - 10000)	1100 (700 - 2500)	4,0
7 + 9	16	2600	2800				5400 (3600 - 10000)	1260 (700 - 2500)	4,0
7 + 12	19	2600	3800				6400 (3600 - 10000)	1490 (700 - 2500)	4,0
7 + 18	25	2600	5600				8200 (3600 - 10000)	1960 (900 - 3000)	4,0
9 + 9	18	2800	2800				5600 (3600 - 10000)	1410 (700 - 2500)	4,0
9 + 12	21	2800	5429				8230 (3600 - 10000)	1650 (700 - 2600)	4,0
9 + 18	27	2800	3800				6600 (3600 - 10000)	2120 (1000 - 3400)	4,0
12 + 12	24	3800	3800				7600 (3600 - 10000)	1890 (900 - 2800)	4,0
12 + 18	30	3800	5600				9400 (3600 - 10000)	2200 (1000 - 3600)	4,0
18 + 18	36	4750	4750				9500 (3600 - 10000)	2200 (1000 - 3600)	4,0
7 + 7 + 7	21	2600	2600	2600			7800 (3600 - 10000)	1650 (700 - 2600)	4,0
7 + 7 + 9	23	2600	2600	2800			8000 (3600 - 10000)	1810 (900 - 2800)	4,0
7 + 7 + 12	26	2600	2600	3800			9000 (3600 - 10000)	2040 (900 - 3000)	4,0
7 + 7 + 18	32	2078	2078	5344			9500 (3600 - 10000)	2200 (1000 - 3600)	4,0
7 + 9 + 9	25	2600	2800	2800			8200 (3600 - 10000)	1960 (900 - 3000)	4,0



FM 28

FRÍO									
Unidad interior conectada	Capacidad total	Unidad int. A	Unidad int. B	Unidad int. C	Unidad int. D	Unidad int. E	Potencia (min-max) W	Consumo eléctrico (min-max) W	SEER
7 + 9 + 12	28	2000	2571	3429			8000 (2500 - 10000)	2120 (1300 - 3600)	6,5
7 + 9 + 18	34	1647	2118	4235			8000 (2500 - 10000)	2120 (1300 - 3600)	6,5
7 + 12 + 12	31	1806	3097	3097			8000 (2500 - 10000)	2120 (1300 - 3600)	6,5
7 + 12 + 18	37	1514	2595	3892			8000 (2500 - 10000)	2120 (1300 - 3600)	6,5
9 + 9 + 9	27	2667	2667	2667			8000 (2500 - 8640)	2000 (1300 - 3400)	6,5
9 + 9 + 12	30	2400	2400	3200			8000 (2500 - 10000)	2120 (1300 - 3600)	6,5
9 + 9 + 18	36	2000	2000	4000			8000 (2500 - 10000)	2120 (1300 - 3600)	6,5
9 + 12 + 12	33	2182	2909	2909			8000 (2500 - 10000)	2120 (1300 - 3600)	6,5
9 + 12 + 18	39	1846	2462	3692			8000 (2500 - 10000)	2120 (1300 - 3600)	6,5
12 + 12 + 12	36	2667	2667	2667			8000 (2500 - 10000)	2120 (1300 - 3600)	6,5
12 + 12 + 18	42	2286	2286	3429			8000 (2500 - 10000)	2120 (1300 - 3600)	6,5
7 + 7 + 7 + 7	28	2000	2000	2000	2000		8000 (2500 - 10000)	2120 (1300 - 3600)	7,2
7 + 7 + 7 + 9	30	1867	1867	1867	2400		8000 (2500 - 10000)	2120 (1300 - 3600)	7,2
7 + 7 + 7 + 12	33	1697	1697	1697	2909		8000 (2500 - 10000)	2120 (1300 - 3600)	7,2
7 + 7 + 7 + 18	39	1436	1436	1436	3692		8000 (2500 - 10000)	2120 (1300 - 3600)	7,2
7 + 7 + 9 + 9	32	1750	1750	2250	2250		8000 (2500 - 10000)	2120 (1300 - 3600)	7,2
7 + 7 + 9 + 12	35	1600	1600	2057	2743		8000 (2500 - 10000)	2120 (1300 - 3600)	7,2
7 + 7 + 9 + 18	41	1366	1366	1756	3512		8000 (2500 - 10000)	2120 (1300 - 3600)	7,2
7 + 7 + 12 + 12	38	1474	1474	2526	2526		8000 (2500 - 10000)	2120 (1300 - 3600)	7,2
7 + 9 + 9 + 9	34	1647	2118	2118	2118		8000 (2500 - 10000)	2120 (1300 - 3600)	7,2
7 + 9 + 9 + 12	37	1514	1946	1946	2595		8000 (2500 - 10000)	2120 (1300 - 3600)	7,2
7 + 9 + 12 + 12	40	1400	1800	2400	2400		8000 (2500 - 10000)	2120 (1300 - 3600)	7,2
9 + 9 + 9 + 9	36	2000	2000	2000	2000		8000 (2500 - 10000)	2120 (1300 - 3600)	7,2
9 + 9 + 9 + 12	39	1846	1846	1846	2462		8000 (2500 - 10000)	2120 (1300 - 3600)	7,2
9 + 9 + 12 + 12	42	1714	1714	2286	2286		8000 (2500 - 10000)	2120 (1300 - 3600)	7,2

FM 28

CALOR									
Unidad interior conectada	Capacidad total	Unidad int. A	Unidad int. B	Unidad int. C	Unidad int. D	Unidad int. E	Potencia (min-max) W	Consumo eléctrico (min-max) W	SCOP
7 + 9 + 12	28	2600	2800	4000			9400 (3600 - 10000)	2200 (1000 - 3600)	4,0
7 + 9 + 18	34	1956	2515	5029			9500 (3600 - 10000)	2200 (1000 - 3600)	4,0
7 + 12 + 12	31	2500	3500	3500			9500 (3600 - 10000)	2200 (1000 - 3600)	4,0
7 + 12 + 18	37	1797	3081	4622			9500 (3600 - 10000)	2200 (1000 - 3600)	4,0
9 + 9 + 9	27	3167	3167	3167			9500 (3600 - 10000)	2120 (1000 - 3400)	4,0
9 + 9 + 12	30	2850	2850	3800			9500 (3600 - 10000)	2200 (1000 - 3600)	4,0
9 + 9 + 18	36	2375	2375	4750			9500 (3600 - 10000)	2200 (1000 - 3600)	4,0
9 + 12 + 12	33	2591	3455	3455			9500 (3600 - 10000)	2200 (1000 - 3600)	4,0
9 + 12 + 18	39	2192	2923	4385			9500 (3600 - 10000)	2200 (1000 - 3600)	4,0
12 + 12 + 12	36	3167	3167	3167			9500 (3600 - 10000)	2200 (1000 - 3600)	4,0
12 + 12 + 18	42	2714	2714	4071			9500 (3600 - 10000)	2200 (1000 - 3600)	4,0
7 + 7 + 7 + 7	28	2375	2375	2375	2375		9500 (3600 - 10000)	2200 (1000 - 3600)	4,0
7 + 7 + 7 + 9	30	2217	2217	2217	2850		9500 (3600 - 10000)	2200 (1000 - 3600)	4,0
7 + 7 + 7 + 12	33	2015	2015	2015	3455		9500 (3600 - 10000)	2200 (1000 - 3600)	4,0
7 + 7 + 7 + 18	39	1705	1705	1705	4385		9500 (3600 - 10000)	2200 (1000 - 3600)	4,0
7 + 7 + 9 + 9	32	2078	2078	2672	2672		9500 (3600 - 10000)	2200 (1000 - 3600)	4,0
7 + 7 + 9 + 12	35	1900	1900	2443	3257		9500 (3600 - 10000)	2200 (1000 - 3600)	4,0
7 + 7 + 9 + 18	41	1622	1622	2085	4171		9500 (3600 - 10000)	2200 (1000 - 3600)	4,0
7 + 7 + 12 + 12	38	1750	1750	3000	3000		9500 (3600 - 10000)	2200 (1000 - 3600)	4,0
7 + 9 + 9 + 9	34	1956	2515	2515	2515		9500 (3600 - 10000)	2200 (1000 - 3600)	4,0
7 + 9 + 9 + 12	37	1797	2311	2311	3081		9500 (3600 - 10000)	2200 (1000 - 3600)	4,0
7 + 9 + 12 + 12	40	1663	2138	2850	2850		9500 (3600 - 10000)	2200 (1000 - 3600)	4,0
9 + 9 + 9 + 9	36	2375	2375	2375	2375		9500 (3600 - 10000)	2200 (1000 - 3600)	4,2
9 + 9 + 9 + 12	39	2192	2192	2192	2923		9500 (3600 - 10000)	2200 (1000 - 3600)	4,2
9 + 9 + 12 + 12	42	2036	2036	2714	2714		9500 (3600 - 10000)	2200 (1000 - 3600)	4,2

FM 36

FRÍO									
Unidad interior conectada	Capacidad total	Unidad int. A	Unidad int. B	Unidad int. C	Unidad int. D	Unidad int. E	Potencia (min-max) W	Consumo eléctrico (min-max) W	SEER
7 + 12	19	2100	3500				5600 (2400 - 6330)	2400 (1600 - 3500)	6,1
7 + 18	25	2100	5000				7100 (2400 - 8330)	2400 (1600 - 3500)	6,1
7 + 21	28	2100	6100				8200 (2400 - 9330)	2400 (1600 - 3500)	6,1
7 + 24	31	2100	7200				9300 (2400 - 10330)	2400 (1600 - 3500)	6,1
9 + 9	18	2600	2600				5200 (2400 - 6000)	2400 (1600 - 3500)	6,1
9 + 12	21	2600	3500				6100 (2400 - 7000)	2400 (1600 - 3500)	6,1
9 + 18	27	2600	5000				7600 (2400 - 9000)	2400 (1600 - 3500)	6,1
9 + 21	30	2600	6100				8700 (2400 - 10000)	2400 (1600 - 3500)	6,1
9 + 24	33	2600	7200				9800 (2400 - 11000)	2600 (1600 - 3600)	6,1
12 + 12	24	3500	3500				7000 (2400 - 8000)	2400 (1600 - 3500)	6,1

FM 36

CALOR									
Unidad interior conectada	Capacidad total	Unidad int. A	Unidad int. B	Unidad int. C	Unidad int. D	Unidad int. E	Potencia (min-max) W	Consumo eléctrico (min-max) W	SCOP
7 + 12	19	2600	3800				6400 (2600 - 7380)	2400 (1607 - 3600)	4,0
7 + 18	25	2600	5600				8200 (2600 - 9720)	2600 (1607 - 4000)	4,0
7 + 21	28	2600	6500				9100 (2600 - 10880)	2800 (1607 - 4200)	4,0
7 + 24	31	2600	8500				11100 (2600 - 12050)	2900 (1607 - 4800)	4,0
9 + 9	18	2800	2800				5600 (2600 - 7000)	2400 (1607 - 3600)	4,0
9 + 12	21	2800	3800				6600 (2600 - 8160)	2500 (1607 - 3800)	4,0
9 + 18	27	2800	5600				8400 (2600 - 10500)	2800 (1607 - 4200)	4,0
9 + 21	30	2800	6500				9300 (2600 - 11660)	2800 (1607 - 4500)	4,0
9 + 24	33	2800	8500				11300 (2600 - 12830)	3040 (1607 - 5000)	4,0
12 + 12	24	3800	3800				7600 (2600 - 9330)	2600 (1607 - 4000)	4,0

FRÍO									
Unidad interior conectada	Capacidad total	Unidad int. A	Unidad int. B	Unidad int. C	Unidad int. D	Unidad int. E	Potencia (min-max) W	Consumo eléctrico (min-max) W	SEER
12 + 18	30	3500	5000				8500 (2400 - 10000)	2400 (1600 - 3500)	6,1
12 + 21	33	3500	6100				9600 (2400 - 11000)	2800 (1600 - 3600)	6,1
12 + 24	36	3500	7000				10500 (2400 - 12000)	3000 (1600 - 4600)	6,1
18 + 18	36	5250	5250				10500 (2400 - 12000)	3000 (1600 - 4600)	6,1
18 + 21	39	4846	5654				10500 (2400 - 12000)	3000 (1600 - 4600)	6,1
18 + 24	42	4500	6000				10500 (2400 - 12000)	3000 (1600 - 4600)	6,1
21 + 21	42	5250	5250				10500 (2400 - 12000)	3000 (1600 - 4600)	6,1
21 + 24	45	4900	5600				10500 (2400 - 12000)	3000 (1600 - 4600)	6,1
24 + 24	48	5250	5250				10500 (2400 - 12000)	3000 (1600 - 4600)	6,1
7 + 7 + 7	21	2100	2100	2100			6300 (2400 - 7000)	2400 (1600 - 3500)	6,1
7 + 7 + 9	23	2100	2100	2600			6800 (2400 - 7660)	2400 (1600 - 3500)	6,1
7 + 7 + 12	26	2100	2100	3500			7700 (2400 - 8660)	2400 (1600 - 3500)	6,1
7 + 7 + 18	32	2100	2100	5000			9200 (2400 - 10660)	2800 (1600 - 4600)	6,1
7 + 7 + 21	35	2100	2100	6100			10300 (2400 - 11660)	2800 (1600 - 4600)	6,1
7 + 7 + 24	38	1934	1934	6632			10500 (2400 - 12000)	3000 (1600 - 4600)	6,1
7 + 9 + 9	25	2100	2600	2600			7300 (2400 - 8330)	2400 (1600 - 3500)	6,1
7 + 9 + 12	28	2100	2600	3500			8200 (2400 - 9330)	2400 (1600 - 3500)	6,1
7 + 9 + 18	34	2100	2600	5000			9700 (2400 - 11330)	3000 (1600 - 4600)	6,1
7 + 9 + 21	37	1986	2554	5959			10500 (2400 - 12000)	3000 (1600 - 4600)	6,1
7 + 9 + 24	40	1838	2363	6300			10500 (2400 - 12000)	3000 (1600 - 4600)	6,1
7 + 12 + 12	31	2100	3500	3500			9100 (2400 - 10330)	2400 (1600 - 3500)	6,1
7 + 12 + 18	37	1986	3405	5108			10500 (2400 - 12000)	3000 (1600 - 4600)	6,1
7 + 12 + 21	40	1838	3150	5513			10500 (2400 - 12000)	3000 (1600 - 4600)	6,1
7 + 12 + 24	43	1709	2930	5860			10500 (2400 - 12000)	3000 (1600 - 4600)	6,1
7 + 18 + 18	43	1709	4395	4395			10500 (2400 - 12000)	3000 (1600 - 4600)	6,1
7 + 18 + 21	46	1598	4109	4793			10500 (2400 - 12000)	3000 (1600 - 4600)	6,1
7 + 18 + 24	49	1500	3857	5143			10500 (2400 - 12000)	3000 (1600 - 4600)	6,1
7 + 21 + 21	49	1500	4500	4500			10500 (2400 - 12000)	3000 (1600 - 4600)	6,1
7 + 21 + 24	52	1413	4240	4846			10500 (2400 - 12000)	3000 (1600 - 4600)	6,1
9 + 9 + 9	27	2600	2600	2600			7800 (2400 - 9000)	2400 (1600 - 3500)	6,1
9 + 9 + 12	30	2600	2600	4200			9400 (2400 - 10000)	2600 (1600 - 3600)	6,1
9 + 9 + 18	36	2625	2625	5250			10500 (2400 - 12000)	3000 (1600 - 4600)	6,1
9 + 9 + 21	39	2423	2423	5654			10500 (2400 - 12000)	3000 (1600 - 4600)	6,1
9 + 9 + 24	42	2250	2250	6000			10500 (2400 - 12000)	3000 (1600 - 4600)	6,1
9 + 12 + 12	33	2600	3500	3500			9600 (2400 - 11000)	3000 (1600 - 4600)	6,1
9 + 12 + 18	39	2423	3231	4846			10500 (2400 - 12000)	3000 (1600 - 4600)	6,1
9 + 12 + 21	42	2250	3000	5250			10500 (2400 - 12000)	3000 (1600 - 4600)	6,1
9 + 12 + 24	45	2100	2800	5600			10500 (2400 - 12000)	3000 (1600 - 4600)	6,1
9 + 18 + 18	45	2100	4200	4200			10500 (2400 - 12000)	3000 (1600 - 4600)	6,1
9 + 18 + 21	48	1969	3938	4594			10500 (2400 - 12000)	3000 (1600 - 4600)	6,1
9 + 18 + 24	51	1853	3706	4941			10500 (2400 - 12000)	3000 (1600 - 4600)	6,1
9 + 21 + 21	51	1853	4324	4324			10500 (2400 - 12000)	3000 (1600 - 4600)	6,1

CALOR									
Unidad interior conectada	Capacidad total	Unidad int. A	Unidad int. B	Unidad int. C	Unidad int. D	Unidad int. E	Potencia (min-max) W	Consumo eléctrico (min-max) W	SCOP
12 + 18	30	3800	5600				9400 (2600 - 11660)	2900 (1607 - 4800)	4,0
12 + 21	33	3800	6500				10300 (2600 - 12830)	3040 (1607 - 5000)	4,0
12 + 24	36	3800	8200				12000 (2600 - 14000)	3040 (1607 - 5000)	4,0
18 + 18	36	6000	6000				12000 (2600 - 14000)	3040 (1607 - 5000)	4,0
18 + 21	39	5538	6462				12000 (2600 - 14000)	3040 (1607 - 5000)	4,0
18 + 24	42	5143	6857				12000 (2600 - 14000)	3040 (1607 - 5000)	4,0
21 + 21	42	6000	6000				12000 (2600 - 14000)	3040 (1607 - 5000)	4,0
21 + 24	45	5600	6400				12000 (2600 - 14000)	3040 (1607 - 5000)	4,0
24 + 24	48	6000	6000				12000 (2600 - 14000)	3040 (1607 - 5000)	4,0
7 + 7 + 7	21	2600	2600	2600			7800 (2600 - 8160)	2400 (1607 - 3600)	4,0
7 + 7 + 9	23	2600	2600	2800			8000 (2600 - 8940)	2600 (1607 - 4000)	4,0
7 + 7 + 12	26	2600	2600	3800			9000 (2600 - 10110)	2800 (1607 - 4200)	4,0
7 + 7 + 18	32	2600	2600	5600			10800 (2600 - 12440)	2900 (1607 - 4800)	4,0
7 + 7 + 21	35	2600	2600	6500			11700 (2600 - 13610)	3040 (1607 - 5000)	4,0
7 + 7 + 24	38	2211	2211	7579			12000 (2600 - 14000)	3040 (1607 - 5000)	4,0
7 + 9 + 9	25	2600	2800	2800			8200 (2600 - 9720)	2800 (1607 - 4200)	4,0
7 + 9 + 12	28	2600	2800	3800			9200 (2600 - 10880)	2900 (1607 - 4800)	4,0
7 + 9 + 18	34	2600	2800	5600			11000 (2600 - 13220)	3040 (1607 - 5000)	4,0
7 + 9 + 21	37	2600	2800	6500			11900 (2600 - 14000)	3040 (1607 - 5000)	4,0
7 + 9 + 24	40	2100	2800	7200			12100 (2600 - 14000)	3040 (1607 - 5000)	4,0
7 + 12 + 12	31	2710	4645	4645			12000 (2600 - 12050)	2900 (1607 - 4800)	4,0
7 + 12 + 18	37	2270	3892	5838			12000 (2600 - 14000)	3040 (1607 - 5000)	4,0
7 + 12 + 21	40	2100	3600	6300			12000 (2600 - 14000)	3040 (1607 - 5000)	4,0
7 + 12 + 24	43	1953	3349	6698			12000 (2600 - 14000)	3040 (1607 - 5000)	4,0
7 + 18 + 18	43	1953	5023	5023			12000 (2600 - 14000)	3040 (1607 - 5000)	4,0
7 + 18 + 21	46	1826	4696	5478			12000 (2600 - 14000)	3040 (1607 - 5000)	4,0
7 + 18 + 24	49	1714	4408	5878			12000 (2600 - 14000)	3040 (1607 - 5000)	4,0
7 + 21 + 21	49	1714	5143	5143			12000 (2600 - 14000)	3040 (1607 - 5000)	4,0
7 + 21 + 24	52	1615	4846	5538			12000 (2600 - 14000)	3040 (1607 - 5000)	4,0
9 + 9 + 9	27	2800	2800	2800			8400 (2600 - 10500)	2800 (1607 - 4200)	4,0
9 + 9 + 12	30	2800	2800	3800			9400 (2600 - 11660)	2900 (1607 - 4800)	4,0
9 + 9 + 18	36	3000	3000	6000			12000 (2600 - 14000)	3040 (1607 - 5000)	4,0
9 + 9 + 21	39	2769	2769	6462			12000 (2600 - 14000)	3040 (1607 - 5000)	4,0
9 + 9 + 24	42	2571	2571	6857			12000 (2600 - 14000)	3040 (1607 - 5000)	4,0
9 + 12 + 12	33	3273	4364	4364			12000 (2600 - 12830)	3040 (1607 - 5000)	4,0
9 + 12 + 18	39	2769	3692	5538			12000 (2600 - 14000)	3040 (1607 - 5000)	4,0
9 + 12 + 21	42	2571	3429	6000			12000 (2600 - 14000)	3040 (1607 - 5000)	4,0
9 + 12 + 24	45	2400	3200	6400			12000 (2600 - 14000)	3040 (1607 - 5000)	4,0
9 + 18 + 18	45	2400	4800	4800			12000 (2600 - 14000)	3040 (1607 - 5000)	4,0
9 + 18 + 21	48	2250	4500	5250			12000 (2600 - 14000)	3040 (1607 - 5000)	4,0
9 + 18 + 24	51	2118	4235	5647			12000 (2600 - 14000)	3040 (1607 - 5000)	4,0
9 + 21 + 21	51	2118	4941	4941			12000 (2600 - 14000)	3040 (1607 - 5000)	4,0



FM 36

FM 36

FRÍO									
Unidad interior conectada	Capacidad total	Unidad int. A	Unidad int. B	Unidad int. C	Unidad int. D	Unidad int. E	Potencia (min-max) W	Consumo eléctrico (min-max) W	SEER
9 + 21 + 24	54	1750	4083	4667			10500 (2400 - 12000)	3000 (1600 - 4600)	6,1
12 + 12 + 12	36	3500	3500	3500			10500 (2400 - 12000)	3000 (1600 - 4600)	6,1
12 + 12 + 18	42	3000	3000	4500			10500 (2400 - 12000)	3000 (1600 - 4600)	6,1
12 + 12 + 21	45	2800	2800	4900			10500 (2400 - 12000)	3000 (1600 - 4600)	6,1
12 + 12 + 24	48	2625	2625	5250			10500 (2400 - 12000)	3000 (1600 - 4600)	6,1
12 + 18 + 18	48	2625	3938	3938			10500 (2400 - 12000)	3000 (1600 - 4600)	6,1
12 + 18 + 21	51	2471	3706	4324			10500 (2400 - 12000)	3000 (1600 - 4600)	6,1
12 + 18 + 24	54	2333	3500	4667			10500 (2400 - 12000)	3000 (1600 - 4600)	6,1
12 + 21 + 21	54	2333	4083	4083			10500 (2400 - 12000)	3000 (1600 - 4600)	6,1
18 + 18 + 18	54	3500	3500	3500			10500 (2400 - 12000)	3000 (1600 - 4600)	6,1
7 + 7 + 7 + 7	28	2100	2100	2100	2100		8400 (2400 - 9330)	2400 (1600 - 3500)	6,1
7 + 7 + 7 + 9	30	2100	2100	2100	2600		8900 (2400 - 10000)	2600 (1600 - 3600)	6,1
7 + 7 + 7 + 12	33	2100	2100	2100	3500		9800 (2400 - 11000)	3000 (1600 - 4600)	6,1
7 + 7 + 7 + 18	39	1885	1885	1885	4846		10500 (2400 - 12000)	3000 (1600 - 4600)	6,1
7 + 7 + 7 + 21	42	1750	1750	1750	5250		10500 (2400 - 12000)	3000 (1600 - 4600)	6,1
7 + 7 + 7 + 24	45	1633	1633	1633	5600		10500 (2400 - 12000)	3000 (1600 - 4600)	6,1
7 + 7 + 9 + 9	32	2100	2100	2600	2600		9400 (2400 - 10660)	3000 (1600 - 4600)	6,1
7 + 7 + 9 + 12	35	2100	2100	2600	3500		10300 (2400 - 11660)	3000 (1600 - 4600)	6,1
7 + 7 + 9 + 18	41	1793	1793	2305	4610		10500 (2400 - 12000)	3000 (1600 - 4600)	6,1
7 + 7 + 9 + 21	44	1670	1670	2148	5011		10500 (2400 - 12000)	3000 (1600 - 4600)	6,1
7 + 7 + 9 + 24	47	1564	1564	2011	5362		10500 (2400 - 12000)	3000 (1600 - 4600)	6,1
7 + 7 + 12 + 12	38	1934	1934	3316	3316		10500 (2400 - 12000)	3000 (1600 - 4600)	6,1
7 + 7 + 12 + 18	44	1670	1670	2864	4295		10500 (2400 - 12000)	3000 (1600 - 4600)	6,1
7 + 7 + 12 + 21	47	1564	1564	2681	4691		10500 (2400 - 12000)	3000 (1600 - 4600)	6,1
7 + 7 + 12 + 24	50	1470	1470	2520	5040		10500 (2400 - 12000)	3000 (1600 - 4600)	6,1
7 + 7 + 18 + 18	50	1470	1470	3780	3780		10500 (2400 - 12000)	3000 (1600 - 4600)	6,1
7 + 7 + 18 + 21	53	1387	1387	3566	4160		10500 (2400 - 12000)	3000 (1600 - 4600)	6,1
7 + 9 + 9 + 9	34	2300	2600	2600	2600		10100 (2400 - 11330)	3000 (1600 - 4600)	6,1
7 + 9 + 9 + 12	37	1986	2554	2554	3405		10500 (2400 - 12000)	3000 (1600 - 4600)	6,1
7 + 9 + 9 + 18	43	1709	2198	2198	4395		10500 (2400 - 12000)	3000 (1600 - 4600)	6,1
7 + 9 + 9 + 21	46	1598	2054	2054	4793		10500 (2400 - 12000)	3000 (1600 - 4600)	6,1
7 + 9 + 9 + 24	49	1500	1929	1929	5143		10500 (2400 - 12000)	3000 (1600 - 4600)	6,1
7 + 9 + 12 + 12	40	1838	2363	3150	3150		10500 (2400 - 12000)	3000 (1600 - 4600)	6,1
7 + 9 + 12 + 18	46	1598	2054	2739	4109		10500 (2400 - 12000)	3000 (1600 - 4600)	6,1
7 + 9 + 12 + 21	49	1500	1929	2571	4500		10500 (2400 - 12000)	3000 (1600 - 4600)	6,1
7 + 9 + 12 + 24	52	1413	1817	2423	4846		10500 (2400 - 12000)	3000 (1600 - 4600)	6,1
7 + 9 + 18 + 18	52	1413	1817	3635	3635		10500 (2400 - 12000)	3000 (1600 - 4600)	6,1
7 + 12 + 12 + 12	43	1709	2930	2930	2930		10500 (2400 - 12000)	3000 (1600 - 4600)	6,1
7 + 12 + 12 + 18	49	1500	2571	2571	3857		10500 (2400 - 12000)	3000 (1600 - 4600)	6,1
7 + 12 + 12 + 21	52	1413	2423	2423	4240		10500 (2400 - 12000)	3000 (1600 - 4600)	6,1

CALOR									
Unidad interior conectada	Capacidad total	Unidad int. A	Unidad int. B	Unidad int. C	Unidad int. D	Unidad int. E	Potencia (min-max) W	Consumo eléctrico (min-max) W	SCOP
9 + 21 + 24	54	2000	4667	5333			12000 (2600 - 14000)	3040 (1607 - 5000)	4,0
12 + 12 + 12	36	4000	4000	4000			12000 (2600 - 14000)	3040 (1607 - 5000)	4,0
12 + 12 + 18	42	3429	3429	5143			12000 (2600 - 14000)	3040 (1607 - 5000)	4,0
12 + 12 + 21	45	3200	3200	5600			12000 (2600 - 14000)	3040 (1607 - 5000)	4,0
12 + 12 + 24	48	3000	3000	6000			12000 (2600 - 14000)	3040 (1607 - 5000)	4,0
12 + 18 + 18	48	3000	4500	4500			12000 (2600 - 14000)	3040 (1607 - 5000)	4,0
12 + 18 + 21	51	2824	4235	4941			12000 (2600 - 14000)	3040 (1607 - 5000)	4,0
12 + 18 + 24	54	2667	4000	5333			12000 (2600 - 14000)	3040 (1607 - 5000)	4,0
12 + 21 + 21	54	2667	4667	4667			12000 (2600 - 14000)	3040 (1607 - 5000)	4,0
18 + 18 + 18	54	4000	4000	4000			12000 (2600 - 14000)	3040 (1607 - 5000)	4,0
7 + 7 + 7 + 7	28	2600	2600	2600	2600		10400 (2600 - 10880)	2800 (1607 - 4200)	4,0
7 + 7 + 7 + 9	30	2600	2600	2600	2800		10600 (2600 - 11660)	2900 (1607 - 4800)	4,0
7 + 7 + 7 + 12	33	2600	2600	2600	3800		11600 (2600 - 12830)	3000 (1607 - 5000)	4,0
7 + 7 + 7 + 18	39	2154	2154	2154	5538		12000 (2600 - 14000)	3040 (1607 - 5000)	4,0
7 + 7 + 7 + 21	42	2000	2000	2000	6000		12000 (2600 - 14000)	3040 (1607 - 5000)	4,0
7 + 7 + 7 + 24	45	1867	1867	1867	6400		12000 (2600 - 14000)	3040 (1607 - 5000)	4,0
7 + 7 + 9 + 9	32	2600	2600	2800	2800		10800 (2600 - 12440)	2900 (1607 - 4800)	4,0
7 + 7 + 9 + 12	35	2600	2600	2800	3800		11800 (2600 - 13610)	3040 (1607 - 5000)	4,0
7 + 7 + 9 + 18	41	2049	2049	2634	5268		12000 (2600 - 14000)	3040 (1607 - 5000)	4,0
7 + 7 + 9 + 21	44	1909	1909	2455	5727		12000 (2600 - 14000)	3040 (1607 - 5000)	4,0
7 + 7 + 9 + 24	47	1787	1787	2298	6128		12000 (2600 - 14000)	3040 (1607 - 5000)	4,0
7 + 7 + 12 + 12	38	2211	2211	3789	3789		12000 (2600 - 14000)	3040 (1607 - 5000)	4,0
7 + 7 + 12 + 18	44	1909	1909	3273	4909		12000 (2600 - 14000)	3040 (1607 - 5000)	4,0
7 + 7 + 12 + 21	47	1787	1787	3064	5362		12000 (2600 - 14000)	3040 (1607 - 5000)	4,0
7 + 7 + 12 + 24	50	1680	1680	2880	5760		12000 (2600 - 14000)	3040 (1607 - 5000)	4,0
7 + 7 + 18 + 18	50	1680	1680	4320	4320		12000 (2600 - 14000)	3040 (1607 - 5000)	4,0
7 + 7 + 18 + 21	53	1585	1585	4075	4755		12000 (2600 - 14000)	3040 (1607 - 5000)	4,0
7 + 9 + 9 + 9	34	2600	2800	2800	2800		11000 (2600 - 13220)	3040 (1607 - 5000)	4,0
7 + 9 + 9 + 12	37	2270	2919	2919	3892		12000 (2600 - 14000)	3040 (1607 - 5000)	4,0
7 + 9 + 9 + 18	43	1953	2512	2512	5023		12000 (2600 - 14000)	3040 (1607 - 5000)	4,0
7 + 9 + 9 + 21	46	1826	2348	2348	5478		12000 (2600 - 14000)	3040 (1607 - 5000)	4,0
7 + 9 + 9 + 24	49	1714	2204	2204	5878		12000 (2600 - 14000)	3040 (1607 - 5000)	4,0
7 + 9 + 12 + 12	40	2100	2700	3600	3600		12000 (2600 - 14000)	3040 (1607 - 5000)	4,0
7 + 9 + 12 + 18	46	1826	2348	3130	4696		12000 (2600 - 14000)	3040 (1607 - 5000)	4,0
7 + 9 + 12 + 21	49	1714	2204	2939	5143		12000 (2600 - 14000)	3040 (1607 - 5000)	4,0
7 + 9 + 12 + 24	52	1615	2077	2769	5538		12000 (2600 - 14000)	3040 (1607 - 5000)	4,0
7 + 9 + 18 + 18	52	1615	2077	4154	4154		12000 (2600 - 14000)	3040 (1607 - 5000)	4,0
7 + 12 + 12 + 12	43	1953	3349	3349	3349		12000 (2600 - 14000)	3040 (1607 - 5000)	4,0
7 + 12 + 12 + 18	49	1714	2939	2939	4408		12000 (2600 - 14000)	3040 (1607 - 5000)	4,0
7 + 12 + 12 + 21	52	1615	2769	2769	4846		12000 (2600 - 14000)	3040 (1607 - 5000)	4,0



FM 36

FRÍO									
Unidad interior conectada	Capacidad total	Unidad int. A	Unidad int. B	Unidad int. C	Unidad int. D	Unidad int. E	Potencia (min-max) W	Consumo eléctrico (min-max) W	SEER
9 + 9 + 9 + 9	36	2625	2625	2625	2625		10500 (2400 - 12000)	3000 (1600 - 4600)	7,2
9 + 9 + 9 + 12	39	2423	2423	2423	3231		10500 (2400 - 12000)	3000 (1600 - 4600)	7,2
9 + 9 + 9 + 18	45	2100	2100	2100	4200		10500 (2400 - 12000)	3000 (1600 - 4600)	6,1
9 + 9 + 9 + 21	48	1969	1969	1969	4594		10500 (2400 - 12000)	3000 (1600 - 4600)	6,1
9 + 9 + 9 + 24	51	1853	1853	1853	4941		10500 (2400 - 12000)	3000 (1600 - 4600)	6,1
9 + 9 + 12 + 12	42	2250	2250	3000	3000		10500 (2400 - 12000)	3000 (1600 - 4600)	6,1
9 + 9 + 12 + 18	48	1969	1969	2625	3938		10500 (2400 - 12000)	3000 (1600 - 4600)	6,1
9 + 9 + 12 + 21	51	1853	1853	2471	4324		10500 (2400 - 12000)	3000 (1600 - 4600)	6,1
9 + 9 + 12 + 24	54	1750	1750	2333	4667		10500 (2400 - 12000)	3000 (1600 - 4600)	6,1
9 + 9 + 18 + 18	54	1750	1750	3500	3500		10500 (2400 - 12000)	3000 (1600 - 4600)	6,1
9 + 12 + 12 + 12	45	2100	2800	2800	2800		10500 (2400 - 12000)	3000 (1600 - 4600)	6,1
9 + 12 + 12 + 18	51	1853	2471	2471	3706		10500 (2400 - 12000)	3000 (1600 - 4600)	6,1
9 + 12 + 12 + 21	54	1750	2333	2333	4083		10500 (2400 - 12000)	3000 (1600 - 4600)	6,1
12 + 12 + 12 + 12	48	2625	2625	2625	2625		10500 (2400 - 12000)	3000 (1600 - 4600)	6,1
12 + 12 + 12 + 18	54	2333	2333	2333	3500		10500 (2400 - 12000)	3000 (1600 - 4600)	6,1

FM 36

CALOR									
Unidad interior conectada	Capacidad total	Unidad int. A	Unidad int. B	Unidad int. C	Unidad int. D	Unidad int. E	Potencia (min-max) W	Consumo eléctrico (min-max) W	SCOP
9 + 9 + 9 + 9	36	3000	3000	3000	3000		12000 (2600 - 14000)	3040 (1607 - 5000)	4,0
9 + 9 + 9 + 12	39	2769	2769	2769	3692		12000 (2600 - 14000)	3040 (1607 - 5000)	4,0
9 + 9 + 9 + 18	45	2400	2400	2400	4800		12000 (2600 - 14000)	3040 (1607 - 5000)	4,0
9 + 9 + 9 + 21	48	2250	2250	2250	5250		12000 (2600 - 14000)	3040 (1607 - 5000)	4,0
9 + 9 + 9 + 24	51	2118	2118	2118	5647		12000 (2600 - 14000)	3040 (1607 - 5000)	4,0
9 + 9 + 12 + 12	42	2571	2571	3429	3429		12000 (2600 - 14000)	3040 (1607 - 5000)	4,0
9 + 9 + 12 + 18	48	2250	2250	3000	4500		12000 (2600 - 14000)	3040 (1607 - 5000)	4,0
9 + 9 + 12 + 21	51	2118	2118	2824	4941		12000 (2600 - 14000)	3040 (1607 - 5000)	4,0
9 + 9 + 12 + 24	54	2000	2000	2667	5333		12000 (2600 - 14000)	3040 (1607 - 5000)	4,0
9 + 9 + 18 + 18	54	2000	2000	4000	4000		12000 (2600 - 14000)	3040 (1607 - 5000)	4,0
9 + 12 + 12 + 12	45	2400	3200	3200	3200		12000 (2600 - 14000)	3040 (1607 - 5000)	4,0
9 + 12 + 12 + 18	51	2118	2824	2824	4235		12000 (2600 - 14000)	3040 (1607 - 5000)	4,0
9 + 12 + 12 + 21	54	2000	2667	2667	4667		12000 (2600 - 14000)	3040 (1607 - 5000)	4,0
12 + 12 + 12 + 12	48	3000	3000	3000	3000		12000 (2600 - 14000)	3040 (1607 - 5000)	4,0
12 + 12 + 12 + 18	54	2667	2667	2667	4000		12000 (2600 - 14000)	3040 (1607 - 5000)	4,0

FM 42

FRÍO									
Unidad interior conectada	Capacidad total	Unidad int. A	Unidad int. B	Unidad int. C	Unidad int. D	Unidad int. E	Potencia (min-max) W	Consumo eléctrico (min-max) W	SEER
7 + 18	25	2100	5000				7100 (2400 - 9040)	2400 (2600 - 3500)	6,1
7 + 21	28	2100	6100				8200 (2400 - 10130)	3400 (2600 - 4600)	6,1
7 + 24	31	2100	7200				9300 (2400 - 11210)	3400 (2600 - 4600)	6,1
9 + 12	21	2600	3500				6100 (2400 - 7600)	3400 (2600 - 4600)	6,1
9 + 18	27	2600	5000				7600 (2400 - 9770)	3400 (2600 - 4600)	6,1
9 + 21	30	2600	6100				8700 (2400 - 10850)	3400 (2600 - 4600)	6,1
9 + 24	33	2600	7200				9800 (2400 - 11940)	3400 (2600 - 4600)	6,1
12 + 12	24	3500	3500				7000 (2400 - 8680)	3400 (2600 - 4600)	6,1
12 + 18	30	3500	5000				8500 (2400 - 10850)	3400 (2600 - 4600)	6,1
12 + 21	33	3500	6100				9600 (2400 - 11940)	3400 (2600 - 4600)	6,1
12 + 24	36	3500	7200				10700 (2400 - 13020)	3400 (2600 - 4600)	6,1
18 + 18	36	5000	5000				10000 (2400 - 13020)	3400 (2600 - 4600)	6,1
18 + 21	39	5000	6100				11100 (2400 - 14110)	3400 (2600 - 4600)	6,1
18 + 24	42	5143	6857				12000 (2400 - 15200)	3400 (2600 - 4600)	6,1
21 + 21	42	6000	6000				12000 (2400 - 15200)	3400 (2600 - 4600)	6,1
21 + 24	45	5600	6400				12000 (2400 - 15200)	3400 (2600 - 4600)	6,1
24 + 24	48	6000	6000				12000 (2400 - 15200)	3400 (2600 - 4600)	6,1
7 + 7 + 7	21	2100	2100	2100			6300 (2400 - 7600)	2400 (2600 - 3500)	6,1
7 + 7 + 9	23	2100	2100	2600			6800 (2400 - 8320)	2400 (2600 - 3500)	6,1
7 + 7 + 12	26	2100	2100	3500			7700 (2400 - 9400)	2400 (2600 - 3500)	6,1

FM 42

CALOR									
Unidad interior conectada	Capacidad total	Unidad int. A	Unidad int. B	Unidad int. C	Unidad int. D	Unidad int. E	Potencia (min-max) W	Consumo eléctrico (min-max) W	SCOP
7 + 18	25	2600	5600				8200 (2600 - 9220)	2400 (1607 - 4200)	4,0
7 + 21	28	2600	6500				9100 (2600 - 10330)	2600 (1607 - 4500)	4,0
7 + 24	31	2600	8500				11100 (2600 - 11440)	2800 (1607 - 4500)	4,0
9 + 12	21	2800	3800				6600 (2600 - 7750)	2400 (1607 - 4200)	4,0
9 + 18	27	2800	5600				8400 (2600 - 9960)	2600 (1607 - 4500)	4,0
9 + 21	30	2800	6500				9300 (2600 - 11070)	2800 (1607 - 4500)	4,0
9 + 24	33	2800	8500				11300 (2600 - 12170)	2800 (1607 - 4500)	4,0
12 + 12	24	3800	3800				7600 (2600 - 8850)	2600 (1607 - 4500)	4,0
12 + 18	30	3800	5600				9400 (2600 - 11070)	2800 (1607 - 4500)	4,0
12 + 21	33	3800	6500				10300 (2600 - 12170)	2800 (1607 - 4500)	4,0
12 + 24	36	3800	8500				12300 (2600 - 13280)	2800 (1607 - 4500)	4,0
18 + 18	36	5600	5600				11200 (2600 - 13280)	2800 (1607 - 4500)	4,0
18 + 21	39	5600	6500				12100 (2600 - 14390)	3190 (1607 - 5000)	4,0
18 + 24	42	5571	7429				13000 (2600 - 15500)	3190 (1607 - 5000)	4,0
21 + 21	42	6500	6500				13000 (2600 - 15500)	3190 (1607 - 5000)	4,0
21 + 24	45	6067	6933				13000 (2600 - 15500)	3190 (1607 - 5000)	4,0
24 + 24	48	6500	6500				13000 (2600 - 15500)	3190 (1607 - 5000)	4,0
7 + 7 + 7	21	2600	2600	2600			7800 (2600 - 7750)	2400 (1607 - 4200)	4,0
7 + 7 + 9	23	2600	2600	2800			8000 (2600 - 8480)	2400 (1607 - 4200)	4,0
7 + 7 + 12	26	2600	2600	3800			9000 (2600 - 9590)	2600 (1607 - 4500)	4,0



## FM 42

FRÍO									
Unidad interior conectada	Capacidad total	Unidad int. A	Unidad int. B	Unidad int. C	Unidad int. D	Unidad int. E	Potencia (min-max) W	Consumo eléctrico (min-max) W	SEER
7 + 7 + 18	32	2100	2100	5000			9200 (2400 - 11580)	2600 (2600 - 3600)	6,1
7 + 7 + 21	35	2100	2100	6100			10300 (2400 - 12660)	3000 (2600 - 4600)	6,1
7 + 7 + 24	38	2100	2100	7200			11400 (2400 - 13750)	3000 (2600 - 4600)	6,1
7 + 9 + 9	25	2100	2600	2600			7300 (2400 - 9040)	2600 (2600 - 3600)	6,1
7 + 9 + 12	28	2100	2600	3500			8200 (2400 - 10130)	2600 (2600 - 3600)	6,1
7 + 9 + 18	34	2100	2600	5000			9700 (2400 - 12300)	3000 (2600 - 4000)	6,1
7 + 9 + 21	37	2100	2600	6100			10800 (2400 - 13390)	3400 (2600 - 4600)	6,1
7 + 9 + 24	40	2100	2600	7200			11900 (2400 - 14470)	3400 (2600 - 4600)	6,1
7 + 12 + 12	31	2100	3500	3500			9100 (2400 - 11210)	3000 (2600 - 4000)	6,1
7 + 12 + 18	37	2100	3500	5000			10600 (2400 - 13390)	3000 (2600 - 4600)	6,1
7 + 12 + 21	40	2100	3500	6100			11700 (2400 - 14470)	3400 (2600 - 4600)	6,1
7 + 12 + 24	43	1953	3500	7200			12000 (2400 - 15200)	3400 (2600 - 4600)	6,1
7 + 18 + 18	43	1953	5000	5000			12000 (2400 - 15200)	3400 (2600 - 4600)	6,1
7 + 18 + 21	46	1826	5000	6100			12000 (2400 - 15200)	3400 (2600 - 4600)	6,1
7 + 18 + 24	49	1714	4408	5878			12000 (2400 - 15200)	3400 (2600 - 4600)	6,1
7 + 21 + 21	49	1714	5143	5143			12000 (2400 - 15200)	3400 (2600 - 4600)	6,1
7 + 21 + 24	52	1615	4846	5538			12000 (2400 - 15200)	3400 (2600 - 4600)	6,1
7 + 24 + 24	55	1527	5236	5236			12000 (2400 - 15200)	3400 (2600 - 4600)	6,1
9 + 9 + 9	27	2600	2600	2600			7800 (2400 - 9770)	3400 (2600 - 4600)	6,1
9 + 9 + 12	30	2600	2600	3500			8700 (2400 - 10850)	3400 (2600 - 4600)	6,1
9 + 9 + 18	36	2600	2600	5000			10200 (2400 - 13020)	3000 (2600 - 4600)	6,1
9 + 9 + 21	39	2600	2600	6100			11300 (2400 - 14110)	3400 (2600 - 4600)	6,1
9 + 9 + 24	42	2571	2571	6857			12000 (2400 - 15200)	3400 (2600 - 4600)	6,1
9 + 12 + 12	33	2600	3500	3500			9600 (2400 - 11940)	3000 (2600 - 4600)	6,1
9 + 12 + 18	39	2600	3500	5000			11100 (2400 - 14110)	3400 (2600 - 4600)	6,1
9 + 12 + 21	42	2571	3429	6000			12000 (2400 - 15200)	3400 (2600 - 4600)	6,1
9 + 12 + 24	45	2400	3200	6400			12000 (2400 - 15200)	3400 (2600 - 4600)	6,1
9 + 18 + 18	45	2400	4800	4800			12000 (2400 - 15200)	3400 (2600 - 4600)	6,1
9 + 18 + 21	48	2250	4500	5250			12000 (2400 - 15200)	3400 (2600 - 4600)	6,1
9 + 18 + 24	51	2118	4235	5647			12000 (2400 - 15200)	3400 (2600 - 4600)	6,1
9 + 21 + 21	51	2118	4941	4941			12000 (2400 - 15200)	3400 (2600 - 4600)	6,1
9 + 21 + 24	54	2000	4667	5333			12000 (2400 - 15200)	3400 (2600 - 4600)	6,1
9 + 24 + 24	57	1895	5053	5053			12000 (2400 - 15200)	3400 (2600 - 4600)	6,1
12 + 12 + 12	36	3500	3500	3500			10500 (2400 - 13020)	3000 (2600 - 4600)	6,1
12 + 12 + 18	42	3429	3429	5143			12000 (2400 - 15200)	3400 (2600 - 4600)	6,1
12 + 12 + 21	45	3200	3200	5600			12000 (2400 - 15200)	3400 (2600 - 4600)	6,1
12 + 12 + 24	48	3000	3000	6000			12000 (2400 - 15200)	3400 (2600 - 4600)	6,1
12 + 18 + 18	48	3000	4500	4500			12000 (2400 - 15200)	3400 (2600 - 4600)	6,1
12 + 18 + 21	51	2824	4235	4941			12000 (2400 - 15200)	3400 (2600 - 4600)	6,1
12 + 18 + 24	54	2667	4000	5333			12000 (2400 - 15200)	3400 (2600 - 4600)	6,1

## FM 42

CALOR									
Unidad interior conectada	Capacidad total	Unidad int. A	Unidad int. B	Unidad int. C	Unidad int. D	Unidad int. E	Potencia (min-max) W	Consumo eléctrico (min-max) W	SCOP
7 + 7 + 18	32	2600	2600	5600			10800 (2600 - 11800)	2800 (1607 - 4500)	4,0
7 + 7 + 21	35	2600	2600	6500			11700 (2600 - 12910)	2800 (1607 - 4500)	4,0
7 + 7 + 24	38	2600	2600	8500			13700 (2600 - 14020)	3190 (1607 - 5000)	4,0
7 + 9 + 9	25	2600	2800	2800			8200 (2600 - 9220)	2600 (1607 - 4500)	4,0
7 + 9 + 12	28	2600	2800	3800			9200 (2600 - 10330)	2600 (1607 - 4500)	4,0
7 + 9 + 18	34	2600	2800	5600			11000 (2600 - 12540)	2800 (1607 - 4500)	4,0
7 + 9 + 21	37	2600	2800	6500			11900 (2600 - 13650)	2800 (1607 - 4500)	4,0
7 + 9 + 24	40	2600	2800	7600			13000 (2600 - 14760)	3190 (1607 - 5000)	4,0
7 + 12 + 12	31	2600	3800	3800			10200 (2600 - 11440)	3200 (1607 - 4000)	4,0
7 + 12 + 18	37	2600	3800	5600			12000 (2600 - 13650)	3200 (1607 - 4000)	4,0
7 + 12 + 21	40	2600	3800	6500			12900 (2600 - 14760)	3190 (1607 - 5000)	4,0
7 + 12 + 24	43	2116	3628	7256			13000 (2600 - 15500)	3190 (1607 - 5000)	4,0
7 + 18 + 18	43	2116	5442	5442			13000 (2600 - 15500)	3190 (1607 - 5000)	4,0
7 + 18 + 21	46	1978	5087	5935			13000 (2600 - 15500)	3190 (1607 - 5000)	4,0
7 + 18 + 24	49	1857	4776	6367			13000 (2600 - 15500)	3190 (1607 - 5000)	4,0
7 + 21 + 21	49	1857	5571	5571			13000 (2600 - 15500)	3190 (1607 - 5000)	4,0
7 + 21 + 24	52	1750	5250	6000			13000 (2600 - 15500)	3190 (1607 - 5000)	4,0
7 + 24 + 24	55	1655	5673	5673			13000 (2600 - 15500)	3190 (1607 - 5000)	4,0
9 + 9 + 9	27	2800	2800	2800			8400 (2600 - 9960)	2600 (1607 - 4500)	4,0
9 + 9 + 12	30	2800	2800	3800			9400 (2600 - 11070)	2800 (1607 - 4500)	4,0
9 + 9 + 18	36	2800	2800	5600			11200 (2600 - 13280)	2800 (1607 - 4500)	4,0
9 + 9 + 21	39	2800	2800	6500			12100 (2600 - 14390)	3190 (1607 - 5000)	4,0
9 + 9 + 24	42	2786	2786	7429			13000 (2600 - 15500)	3190 (1607 - 5000)	4,0
9 + 12 + 12	33	2800	3800	3800			10400 (2600 - 12170)	2800 (1607 - 4500)	4,0
9 + 12 + 18	39	2800	3800	5600			12200 (2600 - 14390)	3190 (1607 - 5000)	4,0
9 + 12 + 21	42	2786	3714	6500			13000 (2600 - 15500)	3190 (1607 - 5000)	4,0
9 + 12 + 24	45	2600	3467	6933			13000 (2600 - 15500)	3190 (1607 - 5000)	4,0
9 + 18 + 18	45	2600	5200	5200			13000 (2600 - 15500)	3190 (1607 - 5000)	4,0
9 + 18 + 21	48	2438	4875	5688			13000 (2600 - 15500)	3190 (1607 - 5000)	4,0
9 + 18 + 24	51	2294	4588	6118			13000 (2600 - 15500)	3190 (1607 - 5000)	4,0
9 + 21 + 21	51	2294	5353	5353			13000 (2600 - 15500)	3190 (1607 - 5000)	4,0
9 + 21 + 24	54	2167	5056	5778			13000 (2600 - 15500)	3190 (1607 - 5000)	4,0
9 + 24 + 24	57	2053	5474	5474			13000 (2600 - 15500)	3190 (1607 - 5000)	4,0
12 + 12 + 12	36	4333	4333	4333			13000 (2600 - 13280)	2800 (1607 - 4500)	4,0
12 + 12 + 18	42	3714	3714	5571			13000 (2600 - 15500)	3190 (1607 - 5000)	4,0
12 + 12 + 21	45	3467	3467	6067			13000 (2600 - 15500)	3190 (1607 - 5000)	4,0
12 + 12 + 24	48	3250	3250	6500			13000 (2600 - 15500)	3190 (1607 - 5000)	4,0
12 + 18 + 18	48	3250	4875	4875			13000 (2600 - 15500)	3190 (1607 - 5000)	4,0
12 + 18 + 21	51	3059	4588	5353			13000 (2600 - 15500)	3190 (1607 - 5000)	4,0
12 + 18 + 24	54	2889	4333	5778			13000 (2600 - 15500)	3190 (1607 - 5000)	4,0

FRÍO									
Unidad interior conectada	Capacidad total	Unidad int. A	Unidad int. B	Unidad int. C	Unidad int. D	Unidad int. E	Potencia (min-max) W	Consumo eléctrico (min-max) W	SEER
12 + 21 + 21	54	2667	4667	4667			12000 (2400 - 15200)	3400 (2600 - 4600)	6,1
12 + 21 + 24	57	2526	4421	5053			12000 (2400 - 15200)	3400 (2600 - 4600)	6,1
12 + 24 + 24	60	2400	4800	4800			12000 (2400 - 15200)	3400 (2600 - 4600)	6,1
18 + 18 + 18	54	4000	4000	4000			12000 (2400 - 15200)	3400 (2600 - 4600)	6,1
18 + 18 + 21	57	3789	3789	4421			12000 (2400 - 15200)	3400 (2600 - 4600)	6,1
18 + 18 + 24	60	3600	3600	4800			12000 (2400 - 15200)	3400 (2600 - 4600)	6,1
18 + 21 + 21	60	3600	4200	4200			12000 (2400 - 15200)	3400 (2600 - 4600)	6,1
18 + 21 + 24	63	3429	4000	4571			12000 (2400 - 15200)	3400 (2600 - 4600)	6,1
21 + 21 + 21	63	4000	4000	4000			12000 (2400 - 15200)	3400 (2600 - 4600)	6,1
7 + 7 + 7 + 7	28	2100	2100	2100	2100		8400 (2400 - 10130)	2600 (2600 - 3600)	6,1
7 + 7 + 7 + 9	30	2100	2100	2100	2600		8900 (2400 - 10850)	2600 (2600 - 3600)	6,1
7 + 7 + 7 + 12	33	2100	2100	2100	3500		9800 (2400 - 11940)	2600 (2600 - 3600)	6,1
7 + 7 + 7 + 18	39	2100	2100	2100	5000		11300 (2400 - 14110)	3400 (2600 - 4600)	6,1
7 + 7 + 7 + 21	42	2000	2000	2000	6000		12000 (2400 - 15200)	3400 (2600 - 4600)	6,1
7 + 7 + 7 + 24	45	1867	1867	1867	6400		12000 (2400 - 15200)	3400 (2600 - 4600)	6,1
7 + 7 + 9 + 9	32	2100	2100	2600	2600		9400 (2400 - 11580)	3400 (2600 - 4600)	6,1
7 + 7 + 9 + 12	35	2100	2100	2600	3500		10300 (2400 - 12660)	3000 (2600 - 4600)	6,1
7 + 7 + 9 + 18	41	2100	2100	2600	5000		11800 (2400 - 14830)	3400 (2600 - 4600)	6,1
7 + 7 + 9 + 21	44	1909	1909	2455	5727		12000 (2400 - 15200)	3400 (2600 - 4600)	6,1
7 + 7 + 9 + 24	47	1787	1787	2298	6128		12000 (2400 - 15200)	3400 (2600 - 4600)	6,1
7 + 7 + 12 + 12	38	2100	2100	3500	3500		11200 (2400 - 13750)	3400 (2600 - 4600)	6,1
7 + 7 + 12 + 18	44	1909	1909	3273	4909		12000 (2400 - 15200)	3400 (2600 - 4600)	6,1
7 + 7 + 12 + 21	47	1787	1787	3064	5362		12000 (2400 - 15200)	3400 (2600 - 4600)	6,1
7 + 7 + 12 + 24	50	1680	1680	2880	5760		12000 (2400 - 15200)	3400 (2600 - 4600)	6,1
7 + 7 + 18 + 18	50	1680	1680	4320	4320		12000 (2400 - 15200)	3400 (2600 - 4600)	6,1
7 + 7 + 18 + 21	53	1585	1585	4075	4755		12000 (2400 - 15200)	3400 (2600 - 4600)	6,1
7 + 7 + 18 + 24	56	1500	1500	3857	5143		12000 (2400 - 15200)	3400 (2600 - 4600)	6,1
7 + 7 + 21 + 21	56	1500	1500	4500	4500		12000 (2400 - 15200)	3400 (2600 - 4600)	6,1
7 + 7 + 21 + 24	59	1424	1424	4271	4881		12000 (2400 - 15200)	3400 (2600 - 4600)	6,1
7 + 7 + 24 + 24	62	1355	1355	4645	4645		12000 (2400 - 15200)	3400 (2600 - 4600)	6,1
7 + 9 + 9 + 9	34	2300	2600	2600	2600		10100 (2400 - 12300)	2600 (2600 - 3600)	6,1
7 + 9 + 9 + 12	37	2300	2600	2600	3500		11000 (2400 - 13390)	3400 (2600 - 4600)	6,1
7 + 9 + 9 + 18	43	1953	2512	2512	5023		12000 (2400 - 15200)	3400 (2600 - 4600)	6,1
7 + 9 + 9 + 21	46	1826	2348	2348	5478		12000 (2400 - 15200)	3400 (2600 - 4600)	6,1
7 + 9 + 9 + 24	49	1714	2204	2204	5878		12000 (2400 - 15200)	3400 (2600 - 4600)	6,1
7 + 9 + 12 + 12	40	2300	2600	3500	3500		11900 (2400 - 14470)	3400 (2600 - 4600)	6,1
7 + 9 + 12 + 18	46	1826	2348	3130	4696		12000 (2400 - 15200)	3400 (2600 - 4600)	6,1
7 + 9 + 12 + 21	49	1714	2204	2939	5143		12000 (2400 - 15200)	3400 (2600 - 4600)	6,1
7 + 9 + 12 + 24	52	1615	2077	2769	5538		12000 (2400 - 15200)	3400 (2600 - 4600)	6,1
7 + 9 + 18 + 18	52	1615	2077	4154	4154		12000 (2400 - 15200)	3400 (2600 - 4600)	6,1

CALOR									
Unidad interior conectada	Capacidad total	Unidad int. A	Unidad int. B	Unidad int. C	Unidad int. D	Unidad int. E	Potencia (min-max) W	Consumo eléctrico (min-max) W	SCOP
12 + 21 + 21	54	2889	5056	5056			13000 (2600 - 15500)	3190 (1607 - 5000)	4,0
12 + 21 + 24	57	2737	4789	5474			13000 (2600 - 15500)	3190 (1607 - 5000)	4,0
12 + 24 + 24	60	2600	5200	5200			13000 (2600 - 15500)	3190 (1607 - 5000)	4,0
18 + 18 + 18	54	4333	4333	4333			13000 (2600 - 15500)	3190 (1607 - 5000)	4,0
18 + 18 + 21	57	4105	4105	4789			13000 (2600 - 15500)	3190 (1607 - 5000)	4,0
18 + 18 + 24	60	3900	3900	5200			13000 (2600 - 15500)	3190 (1607 - 5000)	4,0
18 + 21 + 21	60	3900	4550	4550			13000 (2600 - 15500)	3190 (1607 - 5000)	4,0
18 + 21 + 24	63	3714	4333	4952			13000 (2600 - 15500)	3190 (1607 - 5000)	4,0
21 + 21 + 21	63	4333	4333	4333			13000 (2600 - 15500)	3190 (1607 - 5000)	4,0
7 + 7 + 7 + 7	28	2600	2600	2600	2600		13000 (2600 - 10330)	2600 (1607 - 4500)	4,0
7 + 7 + 7 + 9	30	2600	2600	2600	2800		13000 (2600 - 11070)	2800 (1607 - 4500)	4,0
7 + 7 + 7 + 12	33	2600	2600	2600	3800		13000 (2600 - 12170)	2800 (1607 - 4500)	4,0
7 + 7 + 7 + 18	39	2600	2600	2600	5600		13000 (2600 - 14390)	3190 (1607 - 5000)	4,0
7 + 7 + 7 + 21	42	2167	2167	2167	6500		13000 (2600 - 15500)	3190 (1607 - 5000)	4,0
7 + 7 + 7 + 24	45	2022	2022	2022	6933		13000 (2600 - 15500)	3190 (1607 - 5000)	4,0
7 + 7 + 9 + 9	32	2600	2600	2800	2800		13000 (2600 - 11800)	2800 (1607 - 4500)	4,0
7 + 7 + 9 + 12	35	2600	2600	2800	3800		13000 (2600 - 12910)	3000 (1607 - 4800)	4,0
7 + 7 + 9 + 18	41	2220	2220	2854	5707		13000 (2600 - 15130)	3190 (1607 - 5000)	4,0
7 + 7 + 9 + 21	44	2068	2068	2659	6205		13000 (2600 - 15500)	3190 (1607 - 5000)	4,0
7 + 7 + 9 + 24	47	1936	1936	2489	6638		13000 (2600 - 15500)	3190 (1607 - 5000)	4,0
7 + 7 + 12 + 12	38	2395	2395	4105	4105		13000 (2600 - 14020)	3190 (1607 - 5000)	4,0
7 + 7 + 12 + 18	44	2068	2068	3545	5318		13000 (2600 - 15500)	3190 (1607 - 5000)	4,0
7 + 7 + 12 + 21	47	1936	1936	3319	5809		13000 (2600 - 15500)	3190 (1607 - 5000)	4,0
7 + 7 + 12 + 24	50	1820	1820	3120	6240		13000 (2600 - 15500)	3190 (1607 - 5000)	4,0
7 + 7 + 18 + 18	50	1820	1820	4680	4680		13000 (2600 - 15500)	3190 (1607 - 5000)	4,0
7 + 7 + 18 + 21	53	1717	1717	4415	5151		13000 (2600 - 15500)	3190 (1607 - 5000)	4,0
7 + 7 + 18 + 24	56	1625	1625	4179	5571		13000 (2600 - 15500)	3190 (1607 - 5000)	4,0
7 + 7 + 21 + 21	56	1625	1625	4875	4875		13000 (2600 - 15500)	3190 (1607 - 5000)	4,0
7 + 7 + 21 + 24	59	1542	1542	4627	5288		13000 (2600 - 15500)	3190 (1607 - 5000)	4,0
7 + 7 + 24 + 24	62	1468	1468	5032	5032		13000 (2600 - 15500)	3190 (1607 - 5000)	4,0
7 + 9 + 9 + 9	34	2676	3441	3441	3441		13000 (2600 - 12540)	3000 (1607 - 4800)	4,0
7 + 9 + 9 + 12	37	2459	3162	3162	4216		13000 (2600 - 13650)	3000 (1607 - 4800)	4,0
7 + 9 + 9 + 18	43	2116	2721	2721	5442		13000 (2600 - 15500)	3190 (1607 - 5000)	4,0
7 + 9 + 9 + 21	46	1978	2543	2543	5935		13000 (2600 - 15500)	3190 (1607 - 5000)	4,0
7 + 9 + 9 + 24	49	1857	2388	2388	6367		13000 (2600 - 15500)	3190 (1607 - 5000)	4,0
7 + 9 + 12 + 12	40	2275	2925	3900	3900		13000 (2600 - 14760)	3190 (1607 - 5000)	4,0
7 + 9 + 12 + 18	46	1978	2543	3391	5087		13000 (2600 - 15500)	3190 (1607 - 5000)	4,0
7 + 9 + 12 + 21	49	1857	2388	3184	5571		13000 (2600 - 15500)	3190 (1607 - 5000)	4,0
7 + 9 + 12 + 24	52	1750	2250	3000	6000		13000 (2600 - 15500)	3190 (1607 - 5000)	4,0
7 + 9 + 18 + 18	52	1750	2250	4500	4500		13000 (2600 - 15500)	3190 (1607 - 5000)	4,0



FM 42

FM 42

FRÍO									
Unidad interior conectada	Capacidad total	Unidad int. A	Unidad int. B	Unidad int. C	Unidad int. D	Unidad int. E	Potencia (min-max) W	Consumo eléctrico (min-max) W	SEER
7 + 9 + 18 + 21	55	1527	1964	3927	4582		12000 (2400 - 15200)	3400 (2600 - 4600)	6,1
7 + 9 + 18 + 24	58	1448	1862	3724	4966		12000 (2400 - 15200)	3400 (2600 - 4600)	6,1
7 + 9 + 21 + 21	58	1448	1862	4345	4345		12000 (2400 - 15200)	3400 (2600 - 4600)	6,1
7 + 9 + 21 + 24	61	1377	1770	4131	4721		12000 (2400 - 15200)	3400 (2600 - 4600)	6,1
7 + 12 + 12 + 12	43	1953	3349	3349	3349		12000 (2400 - 15200)	3400 (2600 - 4600)	6,1
7 + 12 + 12 + 18	49	1714	2939	2939	4408		12000 (2400 - 15200)	3400 (2600 - 4600)	6,1
7 + 12 + 12 + 21	52	1615	2769	2769	4846		12000 (2400 - 15200)	3400 (2600 - 4600)	6,1
7 + 12 + 12 + 24	55	1527	2618	2618	5236		12000 (2400 - 15200)	3400 (2600 - 4600)	6,1
7 + 12 + 18 + 18	55	1527	2618	3927	3927		12000 (2400 - 15200)	3400 (2600 - 4600)	6,1
7 + 12 + 18 + 21	58	1448	2483	3724	4345		12000 (2400 - 15200)	3400 (2600 - 4600)	6,1
7 + 12 + 18 + 24	61	1377	2361	3541	4721		12000 (2400 - 15200)	3400 (2600 - 4600)	6,1
7 + 12 + 21 + 21	61	1377	2361	4131	4131		12000 (2400 - 15200)	3400 (2600 - 4600)	6,1
7 + 18 + 18 + 18	61	1377	3541	3541	3541		12000 (2400 - 15200)	3400 (2600 - 4600)	6,1
9 + 9 + 9 + 9	36	2600	2600	2600	2600		10400 (2400 - 13020)	3400 (2600 - 4600)	7,2
9 + 9 + 9 + 12	39	2600	2600	2600	3500		11300 (2400 - 14110)	3400 (2600 - 4600)	7,2
9 + 9 + 9 + 18	45	2400	2400	2400	4800		12000 (2400 - 15200)	3400 (2600 - 4600)	6,1
9 + 9 + 9 + 21	48	2250	2250	2250	5250		12000 (2400 - 15200)	3400 (2600 - 4600)	6,1
9 + 9 + 9 + 24	51	2118	2118	2118	5647		12000 (2400 - 15200)	3400 (2600 - 4600)	6,1
9 + 9 + 12 + 12	42	2571	2571	3429	3429		12000 (2400 - 15200)	3400 (2600 - 4600)	7,2
9 + 9 + 12 + 18	48	2250	2250	3000	4500		12000 (2400 - 15200)	3400 (2600 - 4600)	6,1
9 + 9 + 12 + 21	51	2118	2118	2824	4941		12000 (2400 - 15200)	3400 (2600 - 4600)	6,1
9 + 9 + 12 + 24	54	2000	2000	2667	5333		12000 (2400 - 15200)	3400 (2600 - 4600)	6,1
9 + 9 + 18 + 18	54	2000	2000	4000	4000		12000 (2400 - 15200)	3400 (2600 - 4600)	6,1
9 + 9 + 18 + 21	57	1895	1895	3789	4421		12000 (2400 - 15200)	3400 (2600 - 4600)	6,1
9 + 9 + 18 + 24	60	1800	1800	3600	4800		12000 (2400 - 15200)	3400 (2600 - 4600)	6,1
9 + 9 + 21 + 21	60	1800	1800	4200	4200		12000 (2400 - 15200)	3400 (2600 - 4600)	6,1
9 + 9 + 21 + 24	63	1714	1714	4000	4571		12000 (2400 - 15200)	3400 (2600 - 4600)	6,1
9 + 12 + 12 + 12	45	2400	3200	3200	3200		12000 (2400 - 15200)	3400 (2600 - 4600)	7,2
9 + 12 + 12 + 18	51	2118	2824	2824	4235		12000 (2400 - 15200)	3400 (2600 - 4600)	6,1
9 + 12 + 12 + 21	54	2000	2667	2667	4667		12000 (2400 - 15200)	3400 (2600 - 4600)	6,1
9 + 12 + 12 + 24	57	1895	2526	2526	5053		12000 (2400 - 15200)	3400 (2600 - 4600)	6,1
9 + 12 + 18 + 18	57	1895	2526	3789	3789		12000 (2400 - 15200)	3400 (2600 - 4600)	6,1
9 + 12 + 18 + 21	60	1800	2400	3600	4200		12000 (2400 - 15200)	3400 (2600 - 4600)	6,1
9 + 12 + 18 + 24	63	1714	2286	3429	4571		12000 (2400 - 15200)	3400 (2600 - 4600)	6,1
9 + 12 + 21 + 21	63	1714	2286	4000	4000		12000 (2400 - 15200)	3400 (2600 - 4600)	6,1
9 + 18 + 18 + 18	63	1714	3429	3429	3429		12000 (2400 - 15200)	3400 (2600 - 4600)	6,1
12 + 12 + 12 + 12	48	3000	3000	3000	3000		12000 (2400 - 15200)	3400 (2600 - 4600)	7,2
12 + 12 + 12 + 18	54	2667	2667	2667	4000		12000 (2400 - 15200)	3400 (2600 - 4600)	6,1
12 + 12 + 12 + 21	57	2526	2526	2526	4421		12000 (2400 - 15200)	3400 (2600 - 4600)	6,1
12 + 12 + 12 + 24	60	2400	2400	2400	4800		12000 (2400 - 15200)	3400 (2600 - 4600)	6,1

CALOR									
Unidad interior conectada	Capacidad total	Unidad int. A	Unidad int. B	Unidad int. C	Unidad int. D	Unidad int. E	Potencia (min-max) W	Consumo eléctrico (min-max) W	SCOP
7 + 9 + 18 + 21	55	1655	2127	4255	4964		13000 (2600 - 15500)	3190 (1607 - 5000)	4,0
7 + 9 + 18 + 24	58	1569	2017	4034	5379		13000 (2600 - 15500)	3190 (1607 - 5000)	4,0
7 + 9 + 21 + 21	58	1569	2017	4707	4707		13000 (2600 - 15500)	3190 (1607 - 5000)	4,0
7 + 9 + 21 + 24	61	1492	1918	4475	5115		13000 (2600 - 15500)	3190 (1607 - 5000)	4,0
7 + 12 + 12 + 12	43	2116	3628	3628	3628		13000 (2600 - 15500)	3190 (1607 - 5000)	4,0
7 + 12 + 12 + 18	49	1857	3184	3184	4776		13000 (2600 - 15500)	3190 (1607 - 5000)	4,0
7 + 12 + 12 + 21	52	1750	3000	3000	5250		13000 (2600 - 15500)	3190 (1607 - 5000)	4,0
7 + 12 + 12 + 24	55	1655	2836	2836	5673		13000 (2600 - 15500)	3190 (1607 - 5000)	4,0
7 + 12 + 18 + 18	55	1655	2836	4255	4255		13000 (2600 - 15500)	3190 (1607 - 5000)	4,0
7 + 12 + 18 + 21	58	1569	2690	4034	4707		13000 (2600 - 15500)	3190 (1607 - 5000)	4,0
7 + 12 + 18 + 24	61	1492	2557	3836	5115		13000 (2600 - 15500)	3190 (1607 - 5000)	4,0
7 + 12 + 21 + 21	61	1492	2557	4475	4475		13000 (2600 - 15500)	3190 (1607 - 5000)	4,0
7 + 18 + 18 + 18	61	1492	3836	3836	3836		13000 (2600 - 15500)	3190 (1607 - 5000)	4,0
9 + 9 + 9 + 9	36	3250	3250	3250	3250		13000 (2600 - 13280)	3000 (1607 - 4800)	4,0
9 + 9 + 9 + 12	39	3000	3000	3000	4000		13000 (2600 - 14390)	3190 (1607 - 5000)	4,0
9 + 9 + 9 + 18	45	2600	2600	2600	5200		13000 (2600 - 15500)	3190 (1607 - 5000)	4,0
9 + 9 + 9 + 21	48	2438	2438	2438	5688		13000 (2600 - 15500)	3190 (1607 - 5000)	4,0
9 + 9 + 9 + 24	51	2294	2294	2294	6118		13000 (2600 - 15500)	3190 (1607 - 5000)	4,0
9 + 9 + 12 + 12	42	2786	2786	3714	3714		13000 (2600 - 15500)	3190 (1607 - 5000)	4,0
9 + 9 + 12 + 18	48	2438	2438	3250	4875		13000 (2600 - 15500)	3190 (1607 - 5000)	4,0
9 + 9 + 12 + 21	51	2294	2294	3059	5353		13000 (2600 - 15500)	3190 (1607 - 5000)	4,0
9 + 9 + 12 + 24	54	2167	2167	2889	5778		13000 (2600 - 15500)	3190 (1607 - 5000)	4,0
9 + 9 + 18 + 18	54	2167	2167	4333	4333		13000 (2600 - 15500)	3190 (1607 - 5000)	4,0
9 + 9 + 18 + 21	57	2053	2053	4105	4789		13000 (2600 - 15500)	3190 (1607 - 5000)	4,0
9 + 9 + 18 + 24	60	1950	1950	3900	5200		13000 (2600 - 15500)	3190 (1607 - 5000)	4,0
9 + 9 + 21 + 21	60	1950	1950	4550	4550		13000 (2600 - 15500)	3190 (1607 - 5000)	4,0
9 + 9 + 21 + 24	63	1857	1857	4333	4952		13000 (2600 - 15500)	3190 (1607 - 5000)	4,0
9 + 12 + 12 + 12	45	2600	3467	3467	3467		13000 (2600 - 15500)	3190 (1607 - 5000)	4,0
9 + 12 + 12 + 18	51	2294	3059	3059	4588		13000 (2600 - 15500)	3190 (1607 - 5000)	4,0
9 + 12 + 12 + 21	54	2167	2889	2889	5056		13000 (2600 - 15500)	3190 (1607 - 5000)	4,0
9 + 12 + 12 + 24	57	2053	2737	2737	5474		13000 (2600 - 15500)	3190 (1607 - 5000)	4,0
9 + 12 + 18 + 18	57	2053	2737	4105	4105		13000 (2600 - 15500)	3190 (1607 - 5000)	4,0
9 + 12 + 18 + 21	60	1950	2600	3900	4550		13000 (2600 - 15500)	3190 (1607 - 5000)	4,0
9 + 12 + 18 + 24	63	1857	2476	3714	4952		13000 (2600 - 15500)	3190 (1607 - 5000)	4,0
9 + 12 + 21 + 21	63	1857	2476	4333	4333		13000 (2600 - 15500)	3190 (1607 - 5000)	4,0
9 + 18 + 18 + 18	63	1857	3714	3714	3714		13000 (2600 - 15500)	3190 (1607 - 5000)	4,0
12 + 12 + 12 + 12	48	3250	3250	3250	3250		13000 (2600 - 15500)	3190 (1607 - 5000)	4,0
12 + 12 + 12 + 18	54	2889	2889	2889	4333		13000 (2600 - 15500)	3190 (1607 - 5000)	4,0
12 + 12 + 12 + 21	57	2737	2737	2737	4789		13000 (2600 - 15500)	3190 (1607 - 5000)	4,0
12 + 12 + 12 + 24	60	2600	2600	2600	5200		13000 (2600 - 15500)	3190 (1607 - 5000)	4,0

FRÍO									
Unidad interior conectada	Capacidad total	Unidad int. A	Unidad int. B	Unidad int. C	Unidad int. D	Unidad int. E	Potencia (min-max) W	Consumo eléctrico (min-max) W	SEER
12 + 12 + 18 + 18	60	2400	2400	3600	3600		12000 (2400 - 15200)	3400 (2600 - 4600)	6,1
12 + 12 + 18 + 21	63	2286	2286	3429	4000		12000 (2400 - 15200)	3400 (2600 - 4600)	6,1
7 + 7 + 7 + 7 + 7	35	2100	2100	2100	2100	2100	10500 (2400 - 12660)	3400 (2600 - 4600)	6,1
7 + 7 + 7 + 9 + 7	37	2100	2100	2100	2100	2600	11000 (2400 - 13390)	3400 (2600 - 4600)	6,1
7 + 7 + 7 + 12 + 7	40	2100	2100	2100	2100	3500	11900 (2400 - 14470)	3400 (2600 - 4600)	6,1
7 + 7 + 7 + 18 + 7	46	1826	1826	1826	1826	4696	12000 (2400 - 15200)	3400 (2600 - 4600)	6,1
7 + 7 + 7 + 21 + 7	49	1714	1714	1714	1714	5143	12000 (2400 - 15200)	3400 (2600 - 4600)	6,1
7 + 7 + 7 + 24 + 7	52	1615	1615	1615	1615	5538	12000 (2400 - 15200)	3400 (2600 - 4600)	6,1
7 + 7 + 7 + 9 + 9	39	2100	2100	2100	2600	2600	11500 (2400 - 14110)	3400 (2600 - 4600)	6,1
7 + 7 + 7 + 12 + 9	42	2000	2000	2000	2571	3429	12000 (2400 - 15200)	3400 (2600 - 4600)	6,1
7 + 7 + 7 + 18 + 9	48	1750	1750	1750	2250	4500	12000 (2400 - 15200)	3400 (2600 - 4600)	6,1
7 + 7 + 7 + 21 + 9	51	1647	1647	1647	2118	4941	12000 (2400 - 15200)	3400 (2600 - 4600)	6,1
7 + 7 + 7 + 24 + 9	54	1556	1556	1556	2000	5333	12000 (2400 - 15200)	3400 (2600 - 4600)	6,1
7 + 7 + 7 + 12 + 12	45	1867	1867	1867	3200	3200	12000 (2400 - 15200)	3400 (2600 - 4600)	6,1
7 + 7 + 7 + 18 + 12	51	1647	1647	1647	2824	4235	12000 (2400 - 15200)	3400 (2600 - 4600)	6,1
7 + 7 + 7 + 21 + 12	54	1556	1556	1556	2667	4667	12000 (2400 - 15200)	3400 (2600 - 4600)	6,1
7 + 7 + 7 + 24 + 12	57	1474	1474	1474	2526	5053	12000 (2400 - 15200)	3400 (2600 - 4600)	6,1
7 + 7 + 7 + 18 + 18	57	1474	1474	1474	3789	3789	12000 (2400 - 15200)	3400 (2600 - 4600)	6,1
7 + 7 + 7 + 21 + 18	60	1400	1400	1400	3600	4200	12000 (2400 - 15200)	3400 (2600 - 4600)	6,1
7 + 7 + 7 + 24 + 18	63	1333	1333	1333	3429	4571	12000 (2400 - 15200)	3400 (2600 - 4600)	6,1
7 + 7 + 7 + 21 + 21	63	1333	1333	1333	4000	4000	12000 (2400 - 15200)	3400 (2600 - 4600)	6,1
7 + 7 + 9 + 9 + 9	41	2100	2100	2600	2600	2600	12000 (2400 - 14830)	3400 (2600 - 4600)	6,1
7 + 7 + 9 + 12 + 9	44	1909	1909	2455	2455	3273	12000 (2400 - 15200)	3400 (2600 - 4600)	6,1
7 + 7 + 9 + 18 + 9	50	1680	1680	2160	2160	4320	12000 (2400 - 15200)	3400 (2600 - 4600)	6,1
7 + 7 + 9 + 21 + 9	53	1585	1585	2038	2038	4755	12000 (2400 - 15200)	3400 (2600 - 4600)	6,1
7 + 7 + 9 + 24 + 9	56	1500	1500	1929	1929	5143	12000 (2400 - 15200)	3400 (2600 - 4600)	6,1
7 + 7 + 9 + 12 + 12	47	1787	1787	2298	3064	3064	12000 (2400 - 15200)	3400 (2600 - 4600)	6,1
7 + 7 + 9 + 18 + 12	53	1585	1585	2038	2717	4075	12000 (2400 - 15200)	3400 (2600 - 4600)	6,1
7 + 7 + 9 + 21 + 12	56	1500	1500	1929	2571	4500	12000 (2400 - 15200)	3400 (2600 - 4600)	6,1
7 + 7 + 9 + 24 + 12	59	1424	1424	1831	2441	4881	12000 (2400 - 15200)	3400 (2600 - 4600)	6,1
7 + 7 + 9 + 18 + 18	59	1424	1424	1831	3661	3661	12000 (2400 - 15200)	3400 (2600 - 4600)	6,1
7 + 7 + 9 + 21 + 18	62	1355	1355	1742	3484	4065	12000 (2400 - 15200)	3400 (2600 - 4600)	6,1
7 + 7 + 12 + 12 + 12	50	1680	1680	2880	2880	2880	12000 (2400 - 15200)	3400 (2600 - 4600)	6,1
7 + 7 + 12 + 18 + 12	56	1500	1500	2571	2571	3857	12000 (2400 - 15200)	3400 (2600 - 4600)	6,1
7 + 7 + 12 + 21 + 12	59	1424	1424	2441	2441	4271	12000 (2400 - 15200)	3400 (2600 - 4600)	6,1
7 + 7 + 12 + 24 + 12	62	1355	1355	2323	2323	4645	12000 (2400 - 15200)	3400 (2600 - 4600)	6,1
7 + 7 + 12 + 18 + 18	62	1355	1355	2323	3484	3484	12000 (2400 - 15200)	3400 (2600 - 4600)	6,1

CALOR									
Unidad interior conectada	Capacidad total	Unidad int. A	Unidad int. B	Unidad int. C	Unidad int. D	Unidad int. E	Potencia (min-max) W	Consumo eléctrico (min-max) W	SCOP
12 + 12 + 18 + 18	60	2600	2600	3900	3900		13000 (2600 - 15500)	3190 (1607 - 5000)	4,0
12 + 12 + 18 + 21	63	2476	2476	3714	4333		13000 (2600 - 15500)	3190 (1607 - 5000)	4,0
7 + 7 + 7 + 7 + 7	35	2600	2600	2600	2600	2600	13000 (2600 - 12910)	3000 (1607 - 4800)	4,0
7 + 7 + 7 + 9 + 7	37	2459	2459	2459	2459	3162	13000 (2600 - 13650)	3000 (1607 - 4800)	4,0
7 + 7 + 7 + 12 + 7	40	2275	2275	2275	2275	3900	13000 (2600 - 14760)	3190 (1607 - 5000)	4,0
7 + 7 + 7 + 18 + 7	46	1978	1978	1978	1978	5087	13000 (2600 - 15500)	3190 (1607 - 5000)	4,0
7 + 7 + 7 + 21 + 7	49	1857	1857	1857	1857	5571	13000 (2600 - 15500)	3190 (1607 - 5000)	4,0
7 + 7 + 7 + 24 + 7	52	1750	1750	1750	1750	6000	13000 (2600 - 15500)	3190 (1607 - 5000)	4,0
7 + 7 + 7 + 9 + 9	39	2333	2333	2333	3000	3000	13000 (2600 - 14390)	3190 (1607 - 5000)	4,0
7 + 7 + 7 + 12 + 9	42	2167	2167	2167	2786	3714	13000 (2600 - 15500)	3190 (1607 - 5000)	4,0
7 + 7 + 7 + 18 + 9	48	1896	1896	1896	2438	4875	13000 (2600 - 15500)	3190 (1607 - 5000)	4,0
7 + 7 + 7 + 21 + 9	51	1784	1784	1784	2294	5353	13000 (2600 - 15500)	3190 (1607 - 5000)	4,0
7 + 7 + 7 + 24 + 9	54	1685	1685	1685	2167	5778	13000 (2600 - 15500)	3190 (1607 - 5000)	4,0
7 + 7 + 7 + 12 + 12	45	2022	2022	2022	3467	3467	13000 (2600 - 15500)	3190 (1607 - 5000)	4,0
7 + 7 + 7 + 18 + 12	51	1784	1784	1784	3059	4588	13000 (2600 - 15500)	3190 (1607 - 5000)	4,0
7 + 7 + 7 + 21 + 12	54	1685	1685	1685	2889	5056	13000 (2600 - 15500)	3190 (1607 - 5000)	4,0
7 + 7 + 7 + 24 + 12	57	1596	1596	1596	2737	5474	13000 (2600 - 15500)	3190 (1607 - 5000)	4,0
7 + 7 + 7 + 18 + 18	57	1596	1596	1596	4105	4105	13000 (2600 - 15500)	3190 (1607 - 5000)	4,0
7 + 7 + 7 + 21 + 18	60	1517	1517	1517	3900	4550	13000 (2600 - 15500)	3190 (1607 - 5000)	4,0
7 + 7 + 7 + 24 + 18	63	1444	1444	1444	3714	4952	13000 (2600 - 15500)	3190 (1607 - 5000)	4,0
7 + 7 + 7 + 21 + 21	63	1444	1444	1444	4333	4333	13000 (2600 - 15500)	3190 (1607 - 5000)	4,0
7 + 7 + 9 + 9 + 9	41	2220	2220	2854	2854	2854	13000 (2600 - 15130)	3190 (1607 - 5000)	4,0
7 + 7 + 9 + 12 + 9	44	2068	2068	2659	2659	3545	13000 (2600 - 15500)	3190 (1607 - 5000)	4,0
7 + 7 + 9 + 18 + 9	50	1820	1820	2340	2340	4680	13000 (2600 - 15500)	3190 (1607 - 5000)	4,0
7 + 7 + 9 + 21 + 9	53	1717	1717	2208	2208	5151	13000 (2600 - 15500)	3190 (1607 - 5000)	4,0
7 + 7 + 9 + 24 + 9	56	1625	1625	2089	2089	5571	13000 (2600 - 15500)	3190 (1607 - 5000)	4,0
7 + 7 + 9 + 12 + 12	47	1936	1936	2489	3319	3319	13000 (2600 - 15500)	3190 (1607 - 5000)	4,0
7 + 7 + 9 + 18 + 12	53	1717	1717	2208	2943	4415	13000 (2600 - 15500)	3190 (1607 - 5000)	4,0
7 + 7 + 9 + 21 + 12	56	1625	1625	2089	2786	4875	13000 (2600 - 15500)	3190 (1607 - 5000)	4,0
7 + 7 + 9 + 24 + 12	59	1542	1542	1983	2644	5288	13000 (2600 - 15500)	3190 (1607 - 5000)	4,0
7 + 7 + 9 + 18 + 18	59	1542	1542	1983	3966	3966	13000 (2600 - 15500)	3190 (1607 - 5000)	4,0
7 + 7 + 9 + 21 + 18	62	1468	1468	1887	3774	4403	13000 (2600 - 15500)	3190 (1607 - 5000)	4,0
7 + 7 + 12 + 12 + 12	50	1820	1820	3120	3120	3120	13000 (2600 - 15500)	3190 (1607 - 5000)	4,0
7 + 7 + 12 + 18 + 12	56	1625	1625	2786	2786	4179	13000 (2600 - 15500)	3190 (1607 - 5000)	4,0
7 + 7 + 12 + 21 + 12	59	1542	1542	2644	2644	4627	13000 (2600 - 15500)	3190 (1607 - 5000)	4,0
7 + 7 + 12 + 24 + 12	62	1468	1468	2516	2516	5032	13000 (2600 - 15500)	3190 (1607 - 5000)	4,0
7 + 7 + 12 + 18 + 18	62	1468	1468	2516	3774	3774	13000 (2600 - 15500)	3190 (1607 - 5000)	4,0



# CONDICIONES DE VENTA

Todas las relaciones comerciales entre GREE PRODUCTS, S.L. y sus clientes se regirán por las siguientes condiciones generales de venta que se entenderán aceptadas por el comprador por el solo hecho de cursar un pedido.



## 1. CATÁLOGOS, OFERTAS Y PEDIDOS

**1.1** La información que a título orientativo les facilitamos bajo estos conceptos, tanto en precios, modelos, dimensiones, características y especificaciones no nos obliga a mantenerla y puede ser modificada sin previo aviso.

**1.2** Las ofertas están siempre y a todos los efectos, condicionadas a nuestra posterior aceptación, por escrito, del correspondiente pedido.

**1.3** Cualquier condición consignada por el comprador en el pedido, que no se ajuste a las condiciones generales de venta, se considerará nula, salvo nuestra aceptación que deberá constar expresamente en la aceptación escrita del pedido.

## 2. ANULACIÓN DE PEDIDOS

**2.1** El cliente tiene derecho a la cancelación de cualquier pedido directo de fábrica hasta el plazo de ocho (8) semanas antes a la fecha de entrega comunicada mediante notificación electrónica por Gree. En caso de que el Cliente comunique la cancelación durante el período inferior a las ocho (8) semanas de antelación a la fecha de previsión de entrega informada, ésta comportará la penalización de no abonarse el importe de "manipulación por descarga" previamente acordado y se le facturará al Cliente en concepto de "cargos logísticos por cancelación".

**2.2** Los pedidos aceptados no podrán ser anulados en los casos siguientes:

–Cuando han transcurrido 6 días desde la fecha de recepción por el comprador de nuestra aceptación.

–Cuando se ha efectuado la expedición del pedido.

–Cuando tratándose de materiales de fabricación especial ésta se hubiere comenzado o el material no sea de fabricación propia.

**2.3** Gree se reserva el derecho de anular los pedidos pendientes de entrega cuando el comprador nos hubiere incumplido total o parcialmente anteriores contratos.

## 3. PRECIOS

**3.1** Los precios que figuran en nuestras tarifas son siempre sobre camión o vagón almacén Barcelona, u otros almacenes, excluyendo los productos que tengan una condición expresa.

**3.2** Nuestros precios de venta podrán ser variados por simple aviso al comprador. Los nuevos precios serán aplicados a todos los pedidos pendientes de entrega en la fecha de la modificación. Si el comprador no aceptase el nuevo precio, podrá anular el pedido notificándolo por escrito dentro de los 8 días siguientes a la fecha del aviso. Pasando este plazo se entenderá que acepta plenamente las nuevas condiciones.

## 4. PLAZOS DE ENTREGA

**4.1** Los plazos de entrega que constarán en nuestra aceptación de pedido serán meramente orientativos.

**4.2** El incumplimiento del plazo de entrega, no será causa, en ningún caso de reclamación alguna por parte del comprador.

**4.3** El cliente tiene derecho a demorar la descarga de los contenedores directos de fábrica hasta un máximo de CATORCE (14) días tras la comunicación por medios electrónicos de la llegada de los mismos en el puerto del territorio nacional. Una vez pasados estos 14 días, Gree se reserva el derecho a facturar al cliente en concepto de "costes logísticos portuarios" con un montante equivalente a CINCUENTA EUROS (50 €) por contenedor y día de demora en su descarga.

**4.4** Los retrasos en la entrega originados por causas de fuerza mayor, o que no nos sean directamente imputables, no serán causa justificada para la anulación por el comprador, del pedido involuntariamente demorado.

## 5. FORMA DE ENTREGA

**5.1** Las mercancías se entienden entregadas en nuestros almacenes o depósitos de distribución, cesando nuestra responsabilidad sobre ellas desde el momento en que las ponemos a disposición del porteador.

**5.2** Salvo pacto contrario, o que señale en las condiciones especiales de cada producto, no asumimos los riesgos del transporte, que serán totalmente a cargo del comprador, incluso cuando los daños y menoscabos producidos durante el transporte sean debidos a caso fortuito o fuerza mayor.

El hecho de que contratemos el transporte de las mercancías, y que en algunos casos bonifiquemos su importe, no supondrá la derogación de la cláusula anterior, ni la aceptación por nuestra parte de los riesgos del mismo.

**5.3** Los pedidos que nos cursen, de una cantidad determinada de mercancías, podrán cumplimentarse en entregas parciales.

**5.4** Salvo instrucciones concretas del comprador, los envíos de mercancías se efectuarán por el medio y tarifa más económica.

## 6. EMBALAJES

**6.1** Nuestras mercancías se expedirán embaladas en la forma usual o que se indique previamente en el correspondiente catálogo. En lo razonablemente posible atenderemos las instrucciones del comprador sobre otras clases o formas de embalaje, que se efectuarán al precio de coste.

**6.2** Salvo aviso en contrario, o que se señale en las condiciones particulares de cada producto, el coste de los embalajes, no figura incluido en el precio de las mercancías. Este concepto irá cargado separadamente en nuestras facturas.

**6.3** No se admite la devolución de nuestros embalajes, por ser del tipo no recuperable.

## 7. CONDICIONES DE PAGO

**7.1** El pago del precio de nuestras mercancías debe hacerse por transferencia titularidad de Gree.

**7.2** Para facilitar la efectividad del pago se podrán girar efectos a cargo del comprador, sin que ello signifique una modificación ni de la fecha ni del lugar del pago determinado anteriormente.

**7.3** Si antes de la cumplimentación de la totalidad o parte de un pedido se produjesen o conociesen hechos o circunstancias que originen un fundado temor de que el comprador incumplirá su obligación de pago del precio, se podrá suspender la entrega de las mercancías si el comprador no anticipa su pago o afanza pagarlo en el plazo convenido.

## 8. GARANTÍA CONDICIONES GENERALES

**8.1** Todos los equipos de las gamas Doméstica, Comercial, Industrial, Aeroterma de marca Gree ofertados en el presente catálogo tienen una garantía de 4 años en piezas y compresor, y 3 años en mano de obra. Los portátiles, descodificadores, purificadores tienen una garantía de 3 años (sin mano de obra).

**8.2** Para el uso de la garantía que se ofrece de mano de obra, el producto deberá estar localizado en el territorio nacional. Por tanto, cualquier intervención aun estando en período de garantía que se tenga que realizar fuera de las fronteras del país de actividad de Gree Products SL, no estará cubierta por la garantía de mano de obra.

Asimismo, para el uso de garantía de piezas es necesaria la aceptación del defecto por parte de nuestro Servicio Técnico Oficial de Gree, debiendo ser enviados los productos y/o piezas de recambios defectuosos al almacén de origen. La reposición del material es sin cargo para el comprador y sin que en ningún caso seamos responsables de los daños y perjuicios que por su defecto hayan podido producirse, directa o indirectamente. No se cubren defectos de funcionamiento originados por deficiencias en los suministros de agua, electricidad o de instalación. No se cubren los problemas de conectividad con otros equipos no suministrados por GREE PRODUCTS S.L., manejo por parte del usuario o configuración de los equipos, siempre y cuando éstos no sean provocados por un fallo electrónico. No se incluyen en la garantía equipamientos adicionales como grúa, andamios... o cualquier otro elemento que el SAT necesite para reparar o intervenir el equipo por estar éste ubicado en un lugar inaccesible.

**8.3** Cualquier incidencia relacionada con la carga de gas de las máquinas exteriores de Gree durante su primera PEM, deberá ser notificada en primera instancia al Servicio Técnico Oficial de Gree para que evalúe las posibles causas y soluciones a dicha incidencia. De lo contrario, si el Cliente decide reponer la carga a su cargo y coste, Gree no se responsabilizará de los costes que puedan suponer tal reposición.

## 9. RECLAMACIONES

Además de la garantía, que cubre nuestros productos atenderemos las reclamaciones justificadas por error o defecto en la cantidad de los mismos y cualquier incidencia en relación al suministro, embalaje, transporte si nos es advertida dentro de los 6 días siguientes a la recepción de la mercancía ya que si no consideramos el material conforme y no admitiremos reclamación alguna posterior.

## 10. DEVOLUCIONES

**10.1** No se aceptará la devolución de material bajo ninguna condición, salvo acuerdo excepcional de la dirección y sólo si el embalaje no ha sido abierto. En este caso se aplicará un descuento del 30%. No se aceptarán productos agotados, obsoletos, pedidos especiales ni productos con un valor antes de impuestos inferior a 75 euros.

## 11. PROPIEDAD DE LA MERCANCÍA

**11.1** Continuará siendo propiedad de ésta empresa toda la mercancía que no esté totalmente pagada.

**11.2** Se enviarán franco portes al almacén que previamente se indicará.

## 12. IMPUESTOS

Todos los impuestos actualmente en vigor y los que en el futuro pudieran gravar la producción o venta de dichos artículos, salvo que su repercusión no esté expresamente prohibida y que tengan por causa el hecho de la venta, serán a cargo del cliente.

## 13. PUBLICIDAD

**13.1** El comprador es el único responsable de recabar el consentimiento del usuario final de los productos, para que GREE PRODUCTS pueda realizar fotografías de los equipos Gree colocados en sus instalaciones así como de su entorno, tanto del exterior como en el interior.

**13.2** Asimismo, GREE PRODUCTS informa que podrá utilizar y publicar dicho contenido en la web, en materiales publicitarios, catálogos y comunicados de prensa de Gree y sus marcas.

## 14. JURISDICCIÓN

Comprador y vendedor renunciarán a todo otro fuero y jurisdicción y se someten incondicionalmente a los tribunales de Barcelona.

## 15. PROTECCIÓN DE DATOS

GREE PRODUCTS, S.L. actuará como Responsable del Tratamiento de sus datos. Le comunicamos que tal y como establece el Reglamento (UE) 2016/679 del Parlamento Europeo y la Ley Orgánica 3/2018, de 5 de diciembre, el tratamiento de sus datos personales se basará única y exclusivamente para dar efectivo cumplimiento a la relación contractual que nos vincula. Le informamos que todos los datos que nos ha facilitado serán almacenados de forma segura y que se mantendrán en el sistema mientras sean necesarias para la finalidad para la que se recogieron, también le informamos que los datos podrán ser enviados a los Encargados del Tratamiento, a todas las sociedades de su Grupo consolidado, e incluso encargados del tratamiento ubicados fuera de la UE acogidos al Privacy Shield, para dar cumplimiento a la finalidad para la que se recogieron. Asimismo, se le informa que usted podrá retirar su consentimiento en cualquier momento y ejercer sus derechos de acceso, rectificación o supresión de los datos, poniéndose en contacto con nosotros a través del siguiente correo electrónico: [gopr@greeproducts.es](mailto:gopr@greeproducts.es)



## Gree Products, SL

C/ de Viriat, 47, Planta 7ª, Edificio Numancia 1  
08014 Barcelona  
contact@greeproducts.es

### Almacén

Polígono Industrial Les Arenelles  
Carrer de les Planes, 17  
43814 Vila Rodona, Tarragona

### Comercial Back Office

☎ 932 687 586  
✉ comercial@greeproducts.es

### Asistencia Técnica

☎ 931 820 238  
✉ asistenciatecnica@greeproducts.es

[www.greeproducts.es](http://www.greeproducts.es)

## INFORMACIÓN SOBRE EL DISTRIBUIDOR



En Gree impulsamos e inspiramos nuevas actitudes para hacer posibles grandes cambios. Confiando en Gree contribuyes a un planeta mejor.