

21



Infraestructura e Industria
Tarifa de precios 2021 | Mayo 2021

Infraestructura e Industria

Tarifa 2021

Mayo 2021



Desde Aliaxis comenzamos 2021 con energía positiva para aprovechar juntos las oportunidades que comenzaban a vislumbrarse para este año en el camino incierto que, también juntos, nos tocó recorrer el año pasado.

Ahora nos enfrentamos a un nuevo reto, que aun siendo una situación ajena a Aliaxis, está afectando a la normalidad de nuestros procesos.

El mercado de materias primas derivadas del petróleo está sufriendo una volatilidad sin precedentes, tanto en la disponibilidad como en el precio, que se agudizó a principios de febrero. Hoy, nuestros proveedores anuncian una vez más fuertes subidas y escasez de productos, que están afectando al PVC, polipropileno, polietileno, otras poliolefinas y productos relacionados, y esta tendencia parece que va a ser la tónica al menos hasta junio.

La recuperación repentina de la demanda de plásticos está provocando retrasos y restricciones en la entrega global y, al mismo tiempo, se están produciendo cortes en múltiples niveles de la cadena de suministro, debidos a un cúmulo de causas de fuerza mayor en muchas plantas de la industria petroquímica, incluidos los causados por las recientes tormentas invernales en Estados Unidos y los problemas habidos en el canal de Suez. Y a todo esto, hay que sumar el impacto en la logística, con aumentos significativos en el área de transporte y logística.

Desde Aliaxis queremos mantener la confianza que nos ha unido hasta ahora, **asegurando un suministro confiable y constante**. Por lo que tiene nuestro compromiso de que haremos todo lo que esté en nuestras manos para garantizar la disponibilidad de nuestros productos.

Lamentablemente, toda esta difícil situación que hemos descrito y, que llevamos absorbiendo desde febrero, nos hace imposible mantener vigente durante todo el año la misma estructura de precios, y en consecuencia, nos vemos obligados a ajustar nuestros precios de venta con una **subida del 8%** sobre el PVP publicado en enero 2021. La entrada en vigor de los nuevos precios tendrá lugar a partir del **1 de MAYO 2021**.

Tiene nuestro compromiso de que estamos trabajando para reducir la incertidumbre y minimizar el impacto que este imprevisto e inédito escenario, tenga en su negocio, que es el nuestro. Le mantendremos informado de inmediato de cualquier cambio en este contexto.

Muchas gracias por su confianza. Reciba un afectuoso saludo,

Jorge Barranco

Vicepresidente Aliaxis Iberia

Índice

Infraestructura

1 Tubería de PE	7	6 Equipos y herramientas para accesorios Frialen - Friatools	75
Tubería para agua	8	Máquinas de soldadura	
Flexipol PE100, PE100 RD, PE100 RC, PE100 RT		Rascadores	
Flexipol PE100 ranurado/perforado		Accesorios y herramientas	
Flexipol PE40			
Excel-Plus			
Sistema Push-Fast			
Tubería para gas	19	7 Accesorios de PE inyectados largos	91
Gasypol PE100			
Gasypol PE100 RC		8 Accesorios de PE inyectados cortos	101
Tubería para telecomunicaciones y alta tensión	20		
		9 Accesorios metálicos	111
2 Magnum 3G	21	Uniones y adaptadores brida	
Fitting para tubo de PE	22	Carretes de desmontaje	
Fitting con inserto de latón	27	Abrazaderas de reparación	
Fitting UTC/PE	28		
Fitting alta resistencia química HCR	30	10 Válvulas y accesorios de fundición	137
Válvulas para contador HCR	32	Válvulas	
Repuesto	33	Trampillones	
		Accesorios	
3 Accesorios manipulados de PE	35	Ventosas	
		Hidrantes y bocas de riego	
4 Bridas, portabridas, pasamuros y juntas	45	Collarines, abrazaderas, tomas en carga	
		Bridas	
5 Accesorios electrosoldables Frialen	53		
Accesorios electrosoldables PE			
Tomas simples			
Tomas en carga			
Válvulas PE para agua y gas			

Industria

11 Tubería de PVC-U presión	179	16 Sistema PP-H socket	329
		Tubo y accesorios	332
12 Accesorios de PVC-U presión	181	Válvulas manuales	339
Accesorios encolados, mixtos y roscados		Válvulas actuadas	350
Colectores		Válvulas de control de presión	361
Bridas y adaptadores		17 Sistema PP-H testa/butt welding	363
Uniones 3 piezas		Accesorios	366
Soportes y abrazaderas		18 Sistema PVDF	375
Adhesivos y disolventes		Tubo y accesorios	378
13 Válvulas manuales de PVC-U presión	203	Válvulas manuales	380
Válvulas de bola 2 vías	212	Válvulas actuadas	383
Válvulas de bola 3 vías	217	Válvulas de control de presión	396
Válvulas de 3 vías	218	19 Sistema C-PVC	399
Válvulas de mariposa	219	Tubo y accesorios	402
Válvulas y grifos de membrana	223	Válvulas manuales	406
Válvulas de retención	226	Válvulas actuadas	413
Conectores	230	20 Sistema ABS	427
Filtros inclinados	231	Tubo y accesorios	430
Accesorios para válvulas manuales	233	Válvulas manuales	437
14 Válvulas motorizadas de PVC-U presión	237	Válvulas actuadas	440
Válvulas de solenoide	240	Válvulas de presión	446
Válvulas de bola 2 vías	243	21 Accesorios mecánicos para la unión de tuberías - Straub	447
Válvulas de bola 3 vías	247	22 Recambios	497
Válvulas de mariposa	250		
Actuadores y accesorios	256		
Válvulas de membrana	260		
Accesorios válvulas de membrana	266		
Válvulas de control de presión	270		
15 Medición	271		
Flujómetros modelo corto	274		
Flujómetros modelo largo	292		
Medidores electrónicos de caudal	310		
Sensores de caudal	313		
Electrodos de PH y ORP	317		
Sensores y transmisores de conductividad	319		
Accesorios de instalación y recambios	321		



alixis

Tubería para agua

Flexipol PE100 / PE100 RD / PE100 RC / PE100 RT

Flexipol PE100 ranurado/perforado

Flexypol PE40

Excel-Plus®

Sistema Push-Fast

Tubería para gas

Gasypol PE100 / PE100 RC

Tubería para telecomunicaciones y alta tensión

Tubería de Polietileno

INFRAESTRUCTURA





Declaración de cumplimiento Hessel con la PAS 1075 disponible.

FLEXIPOL TUBOS DE POLIETILENO PE100

Conducción de Agua a Presión
Fabricados según Norma UNE-EN 12201

COLOR Y APLICACIONES

Negro Banda Azul: Agua Potable
Negro-Negro Banda Marrón: Agua no Potable (Aguas Industriales-Saneamiento)
Negro Banda Morada: Agua no Potable (Agua Reciclada)

MARCAJE:

MASA FLEXIPOL

FORMATO DE SUMINISTROS*:

Hasta Ø 90 en rollos de 100 metros
Ø 110 en rollos de 50 metros y 100 metros
Desde Ø 20 hasta Ø 110 barras de 6 metros
Desde Ø 90 hasta Ø 280 en barras de 12 metros
Desde Ø 315 hasta Ø 1000 en barras de 13 metros

* Otros formatos, presiones y aplicaciones consultar
* Precios considerados para un mínimo de 1.200 m. Para otras cantidades consultar.

PN10 / SDR 17 Rollos

Ref.	Ø Ext.	Espesor	€/m
059032010	32	2,0	0,57
059040010	40	2,4	0,94
059050010	50	3,0	1,46
059063010	63	3,8	2,21
059075010	75	4,5	3,06
059090010	90	5,4	4,30
059110010	110	6,6	6,36

* Consultar tipos de ranurado / perforado

PN16 / SDR 11 Rollos

Ref.	Ø Ext.	Espesor	€/m
060020016	20	2,0	0,41
060025016	25	2,3	0,54
060032016	32	3,0	0,80
060040016	40	3,7	1,33
060050016	50	4,6	2,08
060063016	63	5,8	3,15
060075016	75	6,8	4,31
060090016	90	8,2	6,11
060110016	110	10,0	8,97

PN10 / SDR 17 Barras

Ref.	Ø Ext.	Espesor	€/m
059063010	63	3,8	2,21
059075010	75	4,5	3,06
059090010	90	5,4	4,30
059110010	110	6,6	6,36
059125010	125	7,4	7,91
059140010	140	8,3	9,80
059160010	160	9,5	12,69
059180010	180	10,7	16,39
059200010	200	11,9	19,75
059225010	225	13,4	25,17
059250010	250	14,8	30,90
059280010	280	16,6	39,26
059315010	315	18,7	49,58
059355010	355	21,1	62,72
059400010	400	23,7	78,59
059450010	450	26,7	99,50
059500010	500	29,7	123,57
059560010	560	33,2	153,13
059630010	630	37,4	197,65
059710010	710	42,1	246,22
059800010	800	47,4	309,56
059900010	900	53,3	396,69
059100010	1000	59,3	486,04

* Consultar tipos de ranurado / perforado

PN25 / SDR 7,4 Barras

Ref.	Ø Ext.	Espesor	€/m
061063025	63	8,6	4,36
061075025	75	10,3	6,11
061090025	90	12,3	8,63
061110025	110	15,1	12,61
061125025	125	17,1	16,38
061140025	140	19,2	20,30
061160025	160	21,9	26,17
061180025	180	24,6	33,77
061200025	200	27,4	40,92
061225025	225	30,8	52,10
061250025	250	34,2	64,25
061280025	280	38,3	81,38
061315025	315	43,1	102,61

* Consultar tipos de ranurado / perforado

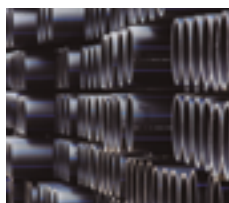
**FLEXIPOL
TUBOS DE POLIETILENO PE100**
PN16 / SDR 11 Barras

Ref.	Ø Ext.	Espesor	€/m
060063016	63	5,8	3,15
060075016	75	6,8	4,31
060090016	90	8,2	6,11
060110016	110	10,0	8,97
060125016	125	11,4	11,59
060140016	140	12,7	14,25
060160016	160	14,6	18,53
060180016	180	16,4	23,97
060200016	200	18,2	28,90
060225016	225	20,5	36,89
060250016	250	22,7	45,32
060280016	280	25,4	57,25
060315016	315	28,6	72,25
060355016	355	32,2	91,05
060400016	400	36,3	114,91
060450016	450	40,9	145,22
060500016	500	45,4	179,59
060560016	560	50,8	223,15
060630016	630	57,2	286,88

* Consultar tipos de ranurado / perforado

PN6 / SDR 26 Barras

Ref.	Ø Ext.	Espesor	€/m
058160006	160	6,2	8,72
058180006	180	6,9	11,13
058200006	200	7,7	13,42
058225006	225	8,6	16,97
058250006	250	9,6	21,05
058280006	280	10,7	26,56
058315006	315	12,1	33,73
058355006	355	13,6	42,43
058400006	400	15,3	53,11
058450006	450	17,2	67,23
058500006	500	19,1	83,67
058560006	560	21,4	103,28
058630006	630	24,1	134,31
058710006	710	27,2	166,58
058800006	800	30,6	208,35
058900006	900	34,4	269,65
058100006	1000	38,2	327,34

* Consultar tipos de ranurado / perforado

PN8 / SDR 21 Barras

Ref.	Ø Ext.	Espesor	€/m
063160008	160	7,7	10,52
063180008	180	8,6	13,53
063200008	200	9,6	16,34
063225008	225	10,8	20,75
063250008	250	11,9	25,43
063280008	280	13,4	32,46
063315008	315	15,0	40,69
063355008	355	16,9	51,38
063400008	400	19,1	64,81
063450008	450	21,5	81,98
063500008	500	23,9	101,85
063560008	560	26,7	125,84
063630008	630	30,0	162,55
063710008	710	33,9	202,64
063800008	800	38,1	254,21
063900008	900	42,9	326,78
063100008	1000	47,7	399,51

* Consultar tipos de ranurado / perforado

FLEXIPOL - TUBOS DE POLIETILENO PE100 RD

Tubo confeccionado con resina RD de última generación aditivada que le confiere una mayor resistencia a la desinfección realizada en las tuberías de agua potable incluso utilizando Dioxido de Cloro.

Reduce los costes de mantenimiento por ataques químicos. La resina PE-100 RD confiere a la tubería una seguridad 3.5 veces mayor que otras resinas (PEX-b HP, PVC, PE-100 Estándar).

Tubo óptimo para acometidas, donde la influencia de las temperaturas y desinfección afecta más a las instalaciones, y donde el PH del agua es elevado (plantas desaladoras).

Diámetros y espesores conforme a la norma UNE EN-12201 y NF-114 (Francia).



Amplio abanico de certificados disponibles:

ACS de materia prima.
Materia prima certificada por AENOR bajo la UNE EN-12201.
Materia prima homologada por LNE (NF-114) Francia.
Materia prima Certificada por IIP (Instituto Italiano del Plástico) Italia.
Materia prima Certificada por HY (Hygiene-Institut des Ruhrgebiets) Alemania.

FLEXIPOL - TUBOS DE POLIETILENO PE100 RC

Tubo confeccionado con resina RC de última generación que le confiere una mayor resistencia a la propagación lenta y rápida de fisuras y a las cargas puntuales

Cumple con los estrictos requisitos de propagación lenta de fisuras de acuerdo a PAS 1075. Declaración de cumplimiento Hessel disponible.

Ventajas respecto a grados PE 100 Estándar: Ahorro en costes de obra civil

El tubo puede ser instalado sin lecho de arena
En función del tipo de árido de la excavación éste puede ser reutilizado

Mejor comportamiento en instalaciones "agresivas".

En instalaciones en terrenos con rocas, piedras etc es importante si el tubo sufre arañazos en la instalación.
Es recomendable para nuevas técnicas de entubado sin zanja: Perforación dirigida, bursting, relining... Donde el tubo sufre abrasión directa

Propiedades Físicas:

Alta resistencia a la propagación lenta de fisuras.

Supera los requisitos estándar del Notched Pipe Test (NPT) según ISO 13479:
Para UNE-EN-1555 > 500h

Para la Asociación PE 100 Plus > 500h

La resina utilizada por MASA > 9.500 h, es decir, superior al año
Supera los requisitos del Full Notch Creep Test (FNCT) Test según ISO 16770:

Para DIBt > 300 h

Para DVGW GW 323 > 3.300 h

La resina utilizada por MASA > 8.760 h, es decir, superior al año

Alta resistencia a la propagación rápida de fisuras.

La resistencia a la propagación rápida de fisuras puede ser medida mediante el Test S4 de acuerdo a la ISO 13477.
La resina utilizada por MASA tiene una alta resistencia en comparación con los requisitos de Ref.:

Para UNE-EN-1555 > 10bar a 0° C

La resina utilizada por MASA alcanza resultados de > 20 bar a -15° C

Amplio abanico de certificados disponibles:

ACS de materia prima y tubo
Materia prima y tubo certificado por AENOR bajo la UNE-EN-12201 y UNE-EN-1555
Materia prima homologada por LNE (NF 114)
Test S4 con diferentes parámetros
Notch Pipe Test >10.500 h
Point Loading Test > 1 Año
DVGW W270
ISO 9080
Compatibilidad de soldadura
Envejecimiento por calor Hessel: Ensayo superado con 2 Mpa
Resistencia al gas condensado

FLEXIPOL - TUBOS DE POLIETILENO PE100 RT

Tubo fabricado con un polietileno de alta densidad (PE100) negro, que combina las tradicionales cualidades de los tubos de polietileno con nuevas propiedades que amplían sus posibilidades y campo de utilización.

- Resistencia química
- Resistencia a la abrasión.
- Buenas propiedades organolépticas (para su uso con agua potable)
- Buena resistencia a la fluencia
- Posibilidad de unión por termofusión.
- Resistencia a la oxidación
- Buena resistencia a la intemperie

- Alta estabilidad dimensional
- Excelentes propiedades de resistencia al agrietamiento por tensión (ESCR)
- Muy buena resistencia hidrostática a largo plazo, incluso a temperaturas elevadas.
- Excelente envejecimiento al calor
- Alta estabilidad frente a la extracción.

Estas propiedades permiten que este tipo de tubos sean utilizados en nuevas aplicaciones, como son el transporte de agua caliente (a temperaturas superiores a los 40°C admitidos para los tubos PE100), unidades de desalinización ó conductos para cables de potencia.

TUBOS FLEXIPOL PE100 RANURADOS O PERFORADOS PARA EL DRENAJE DE LIXIVIADOS Y CAPTACIÓN DE BIOGÁS

Tubos manipulados a partir de tubos estándar de PE100 según UNE-EN-12201

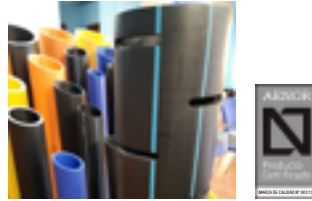

TUBO RANURADO A 1/3 , 2/3 O COMPLETO DE ACUERDO A DIN 4266 Y 4262

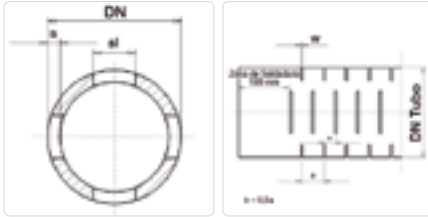

TUBO PERFORADO

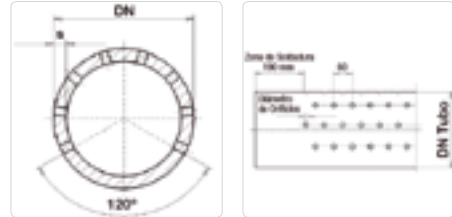

Para medidas solicitar fichas técnicas

TIPOS DE RANURADO

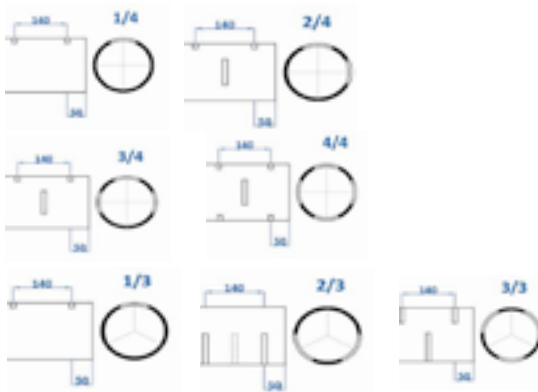

TIPOS DE PERFORACIÓN

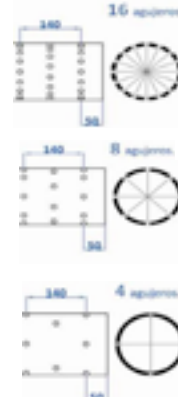

Ø Ext.	PN6	PN10	PN16
63			
75			
90			
110			
125			
140			
160			
180		Consultar	
200			
225			
250			
280			
315			
355			
400			

Ø Ext.	PN6	PN10	PN16
63			
75			
90			
110			
125			
140			
160			
180		Consultar	
200			
225			
250			
280			
315			
355			
400			

Escoger tipo de ranurado, diámetro del tubo y presión.
Ancho ranura 12 mm.

Escoger tipo de perforación, diámetro del tubo y presión.
Ø agujero 12 mm

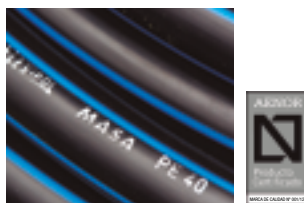

FLEXIPOL
TUBOS DE POLIETILENO PE40

Conducción de Agua a Presión
 Fabricados según Norma UNE-EN 12201

COLOR Y APLICACIONES

Negro Banda Azul: Agua Potable

MARCAJE

MASA FLEXIPOL

FORMATO DE SUMINISTROS*

Hasta Ø 50 en rollos de 100 metros
 Desde Ø63 hasta Ø90 en rollos de 50 metros

* Otros formatos, presiones y aplicaciones consultar
 * Precios considerados para un mínimo de 1.200 m. Para otras cantidades consultar.

PN6 / SDR 11

Ref.	Ø Ext.	Espesor	€/m
032020006	20	2,0	0,59
032025006	25	2,3	0,78
032032006	32	3,0	1,23
032040006	40	3,7	1,94
032050006	50	4,6	3,03
032063006	63	5,8	4,69
032075006	75	6,8	6,97
032090006	90	8,2	9,93

PN10 / SDR 7,4

Ref.	Ø Ext.	Espesor	€/m
033020010	20	3,0	0,76
033025010	25	3,5	1,07
033032010	32	4,4	1,68
033040010	40	5,5	2,66
033050010	50	6,9	4,16
033063010	63	8,6	6,40
033075010	75	10,3	9,60
033090010	90	12,3	13,56

EXCEL-PLUS®

Tubo multicapa para acometidas de agua potable fabricado con PE100 RC y revestimiento interior de PVDF Kynar®. Certificado Sanitario ACS del laboratorio CARSO Laboratoire Santé Environnement Hygiène de Lyon (Francia). Óptimo comportamiento en lugares de desinfección concentrada y alta temperatura.



Resistencia mecánica

El cuerpo en PE100 RC PN16 conforme a norma UNE-EN-12201 dota al tubo de una mayor resistencia mecánica al punzonamiento y a la propagación rápida y lenta de las fisuras. Gran resistencia a los terrenos corrosivos y a la corrosión electrolytica generada por el transporte en ambientes eléctricos.

Inhibición de biofilm

El revestimiento interno de PVDF Kynar® ralentiza considerablemente la proliferación bacteriana en las paredes del tubo en comparación con un tubo estándar de PE, o un acero, y facilita la eliminación de ese biofilm.

Insensibilidad a los desinfectantes

El revestimiento interno de PVDF confiere una protección duradera a la oxidación generada por los desinfectantes. Se trata de un polímero caracterizado por una gran resistencia química a los oxidantes en fuerte concentración y temperatura elevada.

Instalación con accesorios estándar para PE.

Recomendable realizar la unión con accesorios electrosoldables de alta seguridad FRIALEN®

Impermeable a hidrocarburos

Sometido al ensayo (WIS 4-32-19) impuesto a los tubos con barrera de aluminio el tubo Excel Plus® demostró su impermeabilidad a los hidrocarburos presentando idénticas prestaciones que estos multicapas tricapa pero con una mayor facilidad de puesta en obra.

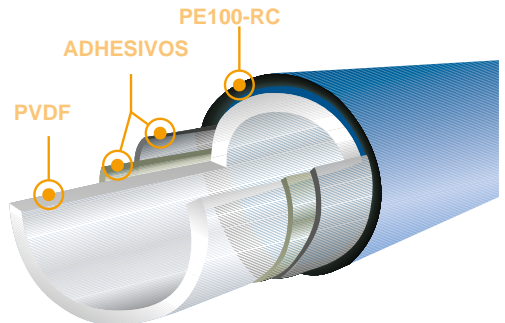

Ø Exterior (mm)	Espesor min. (mm)	Peso (kg/m)	Diámetro rollo 50m (m)	Ancho de rollo (m)	Peso aprox. rollo 50m (kg)	Peso aprox. barra 5m (kg)
25	2,3	0,195	1,20	0,200	10,00	0,98
32	3,0	0,310	1,40	0,200	16,00	1,55
40	3,7	0,469	1,40	0,300	24,00	2,35
50	4,6	0,715	1,70	0,160	36,00	3,58
63	5,8	1,114	1,70	0,260	56,00	5,57
75	6,8	1,542	2,15	0,225	77,11	7,71
90	8,2	2,215	2,50	0,370	110,77	11,08
110	10,0	3,262	-	-	-	16,31

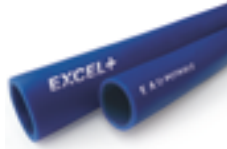

EXCEL-PLUS®

Ref.	Formato	Ø Ext.	Espesor	€/m
X5F0250051M0	Barras 5 mts	25	2,30	8,52
X5F0250502M0	Rollos 50 mts	25	2,30	8,52
X5F0320051M0	Barras 5 mts	32	3,00	11,34
X5F0320502M0	Rollos 50 mts	32	3,00	11,34
X5F0400051M0	Barras 5 mts	40	3,70	15,90
X5F0400502M0	Rollos 50 mts	40	3,70	15,90
X5F0500051M0	Barras 5 mts	50	4,60	18,66
X5F0500502M0	Rollos 50 mts	50	4,60	18,66
X5F0630051M0	Barras 5 mts	63	5,80	25,10
X5F0630502M0	Rollos 50 mts	63	5,80	25,10
X5F0750501M0	Barras 5 mts	75	6,80	33,59
X5F0750502M0	Rollos 50 mts	75	6,80	33,59
X5F0900501M0	Barras 5 mts	90	8,20	41,64
X5F0900502M0	Rollos 50 mts	90	8,20	41,64
X5F1100501M0	Barras 5 mts	110	10,00	53,87

DN	Formato Rollos	Formato Barras
25	Paquetes de 8 rollos (400 metros)	Paquetes de 25 barras (125 metros)
32	Paquetes de 7 rollos (350 metros)	Paquetes de 25 barras (125 metros)
40	Paquetes de 3 rollos (150 metros)	Paquetes de 20 barras (100 metros)
50	Paquetes de 3 rollos (150 metros)	Paquetes de 16 barras (80 metros)
63	Paquetes de 3 rollos (150 metros)	Paquetes de 16 barras (80 metros)
75 a 110	consultar disponibilidad	consultar disponibilidad



SISTEMA DE ACOMETIDA

Set de Acometida	€/ud (Con 1 m de tubo)	€/ud (Con 2 m de tubo)
Set de Acometida DN 25* Toma en carga DAA 63/32 Reducción MR 32/25 Válvula de Bola KH DN 25 Manguito UB DN 25 Tubo Excel Plus DN25	125,52	137,09
Set de Acometida DN 32* Toma en carga DAA 63/32 Manguito UB DN 32 Válvula de Bola KH DN 32 Manguito UB DN 32 Tubo Excel Plus DN32	134,67	150,06

* Consultar precios para otras medidas y/o longitudes de tubo mayores a 1 y 2 m
 Los sets se suministran sin soldar. Posibilidad de suministro con soldaduras bajo petición.



SISTEMA DE UNIÓN DE TUBOS PUSH FAST

El sistema de unión de tubos Push Fast es una innovación ya que facilita la unión de tuberías de PE por el sistema tradicional de “enchufe de campana”, simplificando la unión de los tubos de PE.

COLORES

Cabezal: Negro
Tubo: Negro, Negro Banda Azul, Negro Banda Morada, Negro Banda Marrón, Negro Banda Roja....

VENTAJAS

Unión rápida, sencilla y eficaz: No requiere maquinaria. No requiere anclajes ni mordazas.
Disponibile hasta 16 bares en PE100.
Compatible con PE100, PE80, monotubo....
Fabricados con tubo 6m ó 12 m de longitud.

Ventajas propias del tubo de PE

- Resistencias a los agentes químicos
- Inalterables a la acción de terrenos agresivos
- Ligeros y flexibles

Fácil transporte y manipulación.
Adaptable a terrenos sinuosos.
Excelente comportamiento al golpe de ariete.
Se puede instalar en condiciones adversas: lluvia, presencia de agua en zanja...
La estanqueidad mejora al entrar en carga.
Vida útil de al menos 50 años



Sistema PUSH FAST con tubo de nueva generación PE 100 RC

Ventajas respecto a grados PE 100 Estándar

Ahorro en costes de obra civil

El tubo puede ser instalado sin lecho de arena
En función del tipo de árido de la excavación éste puede ser reutilizado

Mejor comportamiento en instalaciones “agresivas”

En instalaciones en terrenos con rocas, piedras etc es importante si el tubo sufre arañazos en la instalación.

Para más información sobre características físicas del PE 100 RC consultar apartado “Tubos de PE/PVDF y de PE de nueva generación”/ “Tubos con alta resistencia a la fisuración”

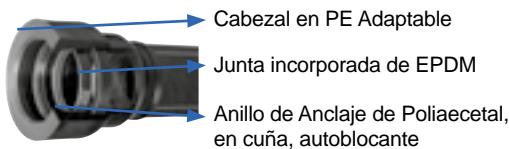

Normativas y Certificaciones

Tubos fabricados según Norma UNE-EN 12201 para conducciones de agua a presión.
Tubos PE100 y PE80 con certificación de producto AENOR y/o AFNOR.

Informe del Instituto de Ciencias de la Construcción Eduardo Torroja:

Ensayos de resistencia a presión interna a corto y largo plazo y depresión de uniones de tubo de PE 100 según la norma UNE-EN-545



CONSEJO SUPERIOR
DE INVESTIGACIONES
CIENTÍFICAS

INSTITUTO DE CIENCIAS
DE LA CONSTRUCCIÓN
EDUARDO TORROJA



TUBO PUSH FAST

CON PE100 ESTÁNDAR

Ref.	Ø Ext.	PN/SDR	Espesor	Barras de 6 m		Barras de 12 m	
				Barras de 6 m	Barras de 12 m	Barras de 6 m	Barras de 12 m
059090010P	90	10/17	5,4	58,56	87,06	59,97	89,86
060090016P	90	16/11	8,2	70,05	111,65	72,09	115,72
059110010P	110	10/17	6,6	83,22	125,01	85,31	129,16
060110016P	110	16/11	10,0	101,19	162,00	104,20	168,05
059125010P	125	10/17	7,4	96,31	149,30	98,97	154,60
060125016P	125	16/11	11,4	120,82	199,25	124,76	207,10
059160010P	160	10/17	9,5	173,33	259,26	177,66	266,83
060160016P	160	16/11	14,6	211,85	338,85	218,27	351,70
059180010P	180	10/17	10,7	176,41	284,66	181,91	295,65
060180016P	180	16/11	16,4	227,50	387,31	235,61	403,55
059225010P	225	10/17	13,4	275,91	445,84	284,51	463,04
060225016P	225	16/11	20,5	354,07	604,28	366,73	629,62
059250010P	250	10/17	14,8	337,25	544,88	347,80	565,96
060250016P	250	16/11	22,7	433,90	740,73	449,49	771,89

CON PE100 RC



MANGUITO PN16 / SDR 11

Ref.	Ø	€/Ud
PMF1P090	90	65,62
PMF1P110	110	86,94
PMF1P125	125	88,66
PMF1P160	160	190,52
PMF1P180	180	141,08
PMF1P225	225	226,31
PMF1P250	250	278,70



CODOS 45° MACHO HEMBRA PN16 / SDR 11

Ref.	Ø	€/Ud
PC4M1P090	90	84,52
PC4M1P110	110	106,98
PC4M1P125	125	122,81
PC4M1P160	160	203,73
PC4M1P180	180	191,18
PC4M1P225	225	298,41
PC4M1P250	250	419,90



CODOS 45° HEMBRA HEMBRA PN16 / SDR 11

Ref.	Ø	€/Ud
PC4F1P090	90	97,46
PC4F1P110	110	121,92
PC4F1P125	125	128,55
PC4F1P160	160	246,05
PC4F1P180	180	233,82
PC4F1P225	225	382,26
PC4F1P250	250	500,36

CODOS 45° HEMBRA EMBRIDADO PN16 / SDR 11

Ref.	Ø	€/Ud
PC4B1P090	90	118,44
PC4B1P110	110	113,88
PC4B1P125	125	159,89
PC4B1P160	160	291,69
PC4B1P180	180	253,74
PC4B1P225	225	458,32
PC4B1P250	250	594,69



CODOS 90° MACHO HEMBRA PN16 / SDR 11

Ref.	Ø	€/Ud
PC9M1C090	90	72,86
PC9M1C110	110	87,15
PC9M1C125	125	92,71
PC9M1C160	160	153,92
PC9M1C180	180	167,07
PC9M1C225	225	255,92
PC9M1C250	250	357,92



CODOS 90° HEMBRA HEMBRA PN16 / SDR 11

Ref.	Ø	€/Ud
PC9F1P090	90	98,29
PC9F1P110	110	124,45
PC9F1P125	125	132,92
PC9F1P160	160	249,91
PC9F1P180	180	242,76
PC9F1P225	225	386,75
PC9F1P250	250	528,58

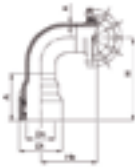

CODOS 90° HEMBRA EMBRIDADO PN16 / SDR 11

Ref.	Ø	€/Ud
PC9B1P090	90	115,96
PC9B1P110	110	106,36
PC9B1P125	125	144,98
PC9B1P160	160	278,34
PC9B1P180	180	268,96
PC9B1P225	225	464,77
PC9B1P250	250	596,72



TE HEMBRA HEMBRA HEMBRA PN16 / SDR 11

Ref.	Ø	€/Ud
PTF1P090	90	139,72
PTF1P110	110	176,33
PTF1P125	125	182,71
PTF1P160	160	385,58
PTF1P180	180	356,27
PTF1P225	225	568,90
PTF1P250	250	717,09



**TE HEMBRA EMBRIDADA HEMBRA
PN16 / SDR 11**

Ref.	Ø	€/Ud
PTB1P090	90	160,84
PTB1P110	110	201,73
PTB1P125	125	209,82
PTB1P160	160	429,73
PTB1P180	180	407,56
PTB1P225	225	681,53
PTB1P250	250	860,55



**TE HEMBRA EMBRIDADA MACHO
PN16 / SDR 11**

Ref.	Ø	€/Ud
PTMB1P090	90	139,01
PTMB1P110	110	169,25
PTMB1P125	125	176,57
PTMB1P160	160	347,95
PTMB1P180	180	350,72
PTMB1P225	225	585,72
PTMB1P250	250	739,28



BRIDA-PORTABRIDA MACHO PN16 / SDR 11

Ref.	Ø	€/Ud
PCOB1P090	90	43,09
PCOB1P110	110	47,36
PCOB1P125	125	49,25
PCOB1P160	160	71,12
PCOB1P180	180	70,16
PCOB1P225	225	86,39
PCOB1P250	250	179,64



BRIDA-PORTABRIDA HEMBRA PN16 / SDR 11

Ref.	Ø	€/Ud
PBE1P090	90	64,93
PBE1P110	110	79,84
PBE1P125	125	82,51
PBE1P160	160	152,90
PBE1P180	180	127,01
PBE1P225	225	182,20
PBE1P250	250	300,90

**GASYPOL
TUBOS DE POLIETILENO
PE100 RC**

Resistente a la propagación rápida y lenta de fisuras y cargas puntuales

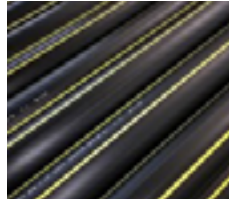

Para Conducción de Combustibles Gaseosos. Fabricados según Norma UNE-EN 1555.
Declaración de cumplimiento Hessel con la PAS 1075 disponible.

COLORES: negro banda amarilla.

MARCAJE*: MASA GASYPOL
**Personalizados bajo petición*

FORMATO DE SUMINISTROS*

Hasta Ø63 en rollos de 100 metros
Ø90 y Ø110 (SDR 11) rollos de 50 metros
Desde Ø110 barras de 8 y 12 metros

** Otros diámetros, longitudes y SDR consultar*

** Precios considerados para un mínimo de 1.200 m.
Para otras cantidades consultar.*

SDR 11

Ø Ext.	Espesor	€/m
20	3,0	1,47
25	3,0	1,91
32	3,0	2,20
40	3,7	3,29
50	4,6	5,12
63	5,8	7,45
90	8,2	15,06
110	10,0	22,33
160	14,6	47,38
200	18,2	73,86
250	22,7	114,97

SDR 17,6

Ø Ext.	Espesor	€/m
63	3,6	4,85
90	5,2	9,98
110	6,3	14,73
160	9,1	30,87
200	11,4	48,18
250	14,2	74,99
315	17,9	118,77

SDR 17**

Ø Ext.	Espesor	€/m
63	3,8	5,09
90	5,4	10,31
110	6,6	15,35
160	9,5	32,06
200	11,9	50,05
250	14,8	77,79
315	18,7	123,78

**** Consultar pedido mínimo**



TUBOS DE POLIETILENO PARA COMUNICACIONES

COLORES

Negro
Personalizados bajo consulta

FORMATO DE SUMINISTROS

Personalizados: rollos y/o bobinas

TIPOS

Monotubo, bitubo y tritubo

Monotubo

Ref.	Ø	€/m
011032	32	2,25
010040	40	3,37
011040	40	3,93
012040	40	4,15
010050	50	3,37
011050	50	4,49
011063	63	4,27



TUBOS DE POLIETILENO PARA CABLES DE ALTA TENSIÓN

Monotubo PE100 banda roja para cables con certificación NF grupo 5

COLORES

Negro banda roja

MARCAJE *

MASA MONOTUBO

**Personalizados bajo petición*

FORMATO DE SUMINISTROS

Rollos, bobinas y barras

Monotubo

Ref.	Ø	€/m
011032	32	2,25
010040	40	3,37
011040	40	3,93
012040	40	4,15
010050	50	3,37
011050	50	4,49
011063	63	4,27



Sistema PUSH FAST para Conducción de Cable de Alta Tensión

Magnum 3G

Sistema para unión de tuberías a presión Magnum 3G

Fitting para tubo de PE

Fitting con inserto de latón

Fitting UTC/PE

Fitting alta resistencia química HCR

Válvulas para contador HCR

Repuestos

Sistema para unión de tuberías a presión

INFRAESTRUCTURA



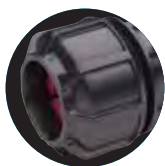

- Gama de accesorios de compresión para tuberías de Polietileno desde 16 hasta 110 mm de diámetro con sistema desliza y aprieta y montaje en sólo 2 pasos.
- Apto para agua potable y adecuado para el transporte de fluidos a presión en industria, infraestructura, edificación y agricultura con una fiabilidad total. 1.600Kpa (PN16) a 20oC.
- Certificaciones de Ø16 a Ø63: KIWA - ACS- AENOR - IIP - DVGW



J-63



Medida	Ref.	U/	n.º	€
16	M55149	50	A-1	2,56
20	M55017	100	A-11	3,18
25	M55018	100	A-9	3,86
32	M55019	50	A-9	5,49
40	M55020	50	A-4	8,60
50	M55003	25	A-4	12,41
63	M55004	20	A-12	18,72
75	M55021	5	A-8	32,21
90	M55022	5	A-9	53,64
110	M55165	2	A-8	83,32

Enlace recto.

J-68



Medida	Ref.	U/	n.º	€
20-16	M55153	50	A-2	3,19
25-16	M55229	50	A-2	3,86
25-20	M55041	50	A-2	3,86
32-20	M55374	25	A-2	5,78
32-25	M55042	25	A-2	5,49
40-25	M55375	25	A-11	10,65
40-32	M55043	25	A-11	10,65
50-25	M55376	15	A-11	14,62
50-32	M55377	15	A-11	14,62
50-40	M55044	15	A-11	14,62
63-32	M55378	15	A-9	17,78
63-40	M55379	15	A-9	17,78
63-50	M55045	15	A-9	18,10
75-63	M55070	5	A-11	32,21
90-75	M55071	5	A-9	53,64
110-90	M55221	2	A-8	80,77

Enlace reducido.

J-95



Medida	Ref.	U/	n.º	€
20	M55330	100	A-11	4,59
25	M55331	100	A-9	5,64
32	M55332	50	A-9	7,11
40	M55333	50	A-12	12,28
50	M55334	25	A-4	16,82
63	M55335	20	A-12	22,36

Enlace recto para reparaciones.

J-97



Medida	Ref.	U/	n.º	€
32	M55394	50	A-9	8,64
40	M55395	25	A-8	12,24
50	M55396	15	A-9	16,71
63	M55397	15	A-12	22,14

Enlace acodado 45°.



J-64

Medida	Ref.	U/	n.º	€
16	M55154	50	A-1	2,56
20	M55029	50	A-2	3,18
25	M55030	50	A-11	3,86
32	M55031	50	A-9	5,67
40	M55032	25	A-8	8,60
50	M55009	15	A-9	12,41
63	M55010	15	A-12	18,68
75	M55033	5	A-9	33,23
90	M55034	5	A-4	55,34
110	M55190	2	A-9	130,67

Enlace acodado 90°.



J-69

Medida	Ref.	U/	n.º	€
16-½"	M55312	50	A-2	3,29
20-½"	M55096	50	A-2	3,20
20-¾"	M55313	50	A-2	3,14
25-½"	M55217	50	A-2	3,95
25-¾"	M55097	50	A-2	3,95
25-1"	M55314	50	A-2	3,87
32-¾"	M55315	25	A-2	4,86
32-1"	M55098	25	A-2	4,97
32-1 ¼"	M55316	25	A-2	4,97
40-1"	M55317	25	A-11	6,29
40-1 ¼"	M55099	25	A-11	6,49
50-1 ¼"	M55318	20	A-9	8,67
50-1 ½"	M55163	20	A-9	8,85
63-2"	M55164	20	A-4	13,48

Enlace acodado 90° rosca macho.



J-59

Medida	Ref.	U/	n.º	€
63	M55735	10	A-4	27,66

Te 45°.



J-71

SIN REFUERZO METALICO

Medida	Ref.	U/	n.º	€
16-½"	M55393	50	A-2	2,93
20-½"	M55135	50	A-2	4,14
20-¾"	M55307	50	A-2	4,06
25-½"	M55218	50	A-2	4,84
25-¾"	M55136	50	A-2	4,80
25-1"	M55308	50	A-2	4,71
32-¾"	M55242	25	A-2	6,00
32-1"	M55137	25	A-2	6,00
32-1 ¼"	M55309	25	A-2	6,93
40-1"	M55310	25	A-11	9,68
40-1 ¼"	M55138	25	A-11	7,50
50-1 ¼"	M55311	20	A-9	10,98
50-1 ½"	M55159	20	A-9	11,20
50-2"	M55364	20	A-9	11,98
63-2"	M55160	20	A-4	13,75

J-71

CON REFUERZO METALICO

Medida	Ref.	U/	n.º	€
20-½"	M55175	50	A-2	4,59
20-¾"	M55366	50	A-2	5,66
25-½"	M55225	50	A-2	5,21
25-¾"	M55176	50	A-2	5,39
25-1"	M55367	50	A-2	5,66
32-¾"	M55243	25	A-2	6,66
32-1"	M55177	25	A-2	6,66
32-1 ¼"	M55368	25	A-2	7,31
40-1"	M55369	25	A-11	10,05
40-1 ¼"	M55178	25	A-11	10,05
50-1 ¼"	M55370	20	A-9	11,36
50-1 ½"	M55188	20	A-9	12,81
50-2"	M55371	20	A-9	12,36
63-2"	M55189	20	A-4	15,80
75-2 ½"	M55257	10	A-9	29,01
90-3"	M55258	6	A-9	39,20
110-4"	M55259	4	A-4	88,33

Enlace acodado 90° rosca hembra.



J-73

Medida	Ref.	U/	n.º	€
16	M55150	50	A-2	4,05
20	M55072	100	A-9	4,84
25	M55073	100	A-4	5,81
32	M55074	25	A-8	8,24
40	M55075	25	A-4	12,85
50	M55086	10	A-9	18,76
63	M55087	10	A-4	28,21
75	M55088	5	A-4	55,34
90	M55089	5	A-4	83,73
110	M55191	2	A-4	149,83

Te bocas iguales.



J-74

Medida	Ref.	U/	n.º	€
25-20	M55115	50	A-8	5,81
25-32	M55380	50	A-8	8,24
32-25	M55116	25	A-8	10,70
40-25	M55381	25	A-9	12,60
40-32	M55117	25	A-9	12,85
50-25	M55382	10	A-9	19,75
50-32	M55383	10	A-9	19,75
50-40	M55118	10	A-9	19,75
63-25	M55384	10	A-4	23,05
63-32	M55385	10	A-4	26,62
63-50	M55119	10	A-4	28,09

Te 90° reducida al centro



J-96

Medida	Ref.	U/	n.º	€
20	M55387	100	A-9	7,01
25	M55388	100	A-4	9,01
32	M55389	25	A-8	11,99
40	M55390	25	A-4	19,49
50	M55391	10	A-9	26,74
63	M55392	10	A-4	36,13

Te 90° para reparaciones.



J-66

Medida	Ref.	U/	n.º	€
40-40	M55365	10	A-11	20,23
50-40	M55100	10	A-11	20,23
50-50	M55373	10	A-11	22,19
63-50	M55101	10	A-9	28,64
75-2 1/2"	M55102	5	A-8	33,12
90-3"	M55103	5	A-9	51,33
110-4"	M55222	2	A-11	96,22

Enlace brida.



J-60

Medida	Ref.	U/	n.º	€
25-1/2"	M55353	50	A-11	5,89
25-3/4"	M55195	50	A-11	6,00
32-1"	M55196	25	A-11	8,22
40-1 1/4"	M55304	50	A-5	15,07
50-1 1/2"	M55305	15	A-9	18,74
63-2"	M55306	15	A-4	35,25

Te 90° rosca macho.



J-65

SIN REFUERZO METALICO

Medida	Ref.	U/	n.º	€
16-½"	M55354	100	A-8	3,56
20-½"	M55023	100	A-8	4,05
20-¾"	M55324	100	A-8	5,61
25-½"	M55219	50	A-11	5,72
25-¾"	M55024	100	A-9	5,72
25-1"	M55325	100	A-8	6,04
32-¾"	M55244	50	A-9	7,84
32-1"	M55025	50	A-9	7,84
32-1 ¼"	M55326	50	A-8	8,86
40-1"	M55328	50	A-12	12,40
40-1 ¼"	M55026	50	A-12	12,40
50-1 ¼"	M55329	15	A-9	13,93
50-1 ½"	M55007	15	A-9	14,76
63-2"	M55008	15	A-4	23,17

J-65

CON REFUERZO METALICO

Medida	Ref.	U/	n.º	€
20-½"	M55183	100	A-8	4,64
20-¾"	M55358	100	A-8	4,68
25-½"	M55224	50	A-11	6,09
25-¾"	M55184	100	A-9	6,26
25-1"	M55359	100	A-9	6,15
32-¾"	M55245	50	A-9	8,46
32-1"	M55185	50	A-9	8,46
32-1 ¼"	M55360	50	A-9	9,42
40-1"	M55362	50	A-4	11,17
40-1 ¼"	M55186	50	A-4	12,61
50-1 ¼"	M55363	15	A-9	14,53
50-1 ½"	M55187	15	A-9	15,80
63-2"	M55141	15	A-4	24,94
75-2 ½"	M55142	5	A-9	43,30
90-3"	M55143	5	A-4	65,05
110-4"	M55227	2	A-4	138,89

Te 90° rosca hembra.



J-65

SIN REFUERZO METALICO

Medida	Ref.	U/	n.º	€
32-1"-25	M55327	50	A-9	6,63

J-65

**CON REFUERZO METALICO
COM REFORÇO METALICO**

Medida	Ref.	U/	n.º	€
32-1"-25	M55361	50	A-9	7,69

Te 90° rosca hembra reducida.



J-72

SIN REFUERZO METALICO

Medida	Ref.	U/	n.º	€
20-½"	M55076	50	A-2	4,28
25-¾"	M55077	50	A-11	4,61

J-72

CON REFUERZO METALICO

Medida	Ref.	U/	n.º	€
20-½"	M55179	50	A-2	5,24
25-¾"	M55180	50	A-11	5,81

Codo grifo 90°.



J-78

Medida	Ref.	U/	n.º	€
16	M55372	50	A-1	2,32
20	M55104	50	A-1	2,56
25	M55105	50	A-2	2,87
32	M55106	25	A-2	4,49
40	M55107	25	A-11	5,54
50	M55108	10	A-2	8,16
63	M55109	10	A-11	11,74
75	M55110	5	A-11	20,93
90	M55111	5	A-8	34,28
110	M55223	2	A-2	69,37

Tapón final.



J-61

Medida	Ref.	U/	n.º	€
16-3/8"	M55148	50	A-10	1,60
16-1/2"	M55147	50	A-10	1,60
16-3/4"	M55336	50	A-10	1,57
20-1/2"	M55011	100	A-2	1,97
20-3/4"	M55132	50	A-1	2,71
25-1/2"	M55133	50	A-2	2,71
25-3/4"	M55012	100	A-11	2,46
25-1"	M55213	50	A-2	2,56
32-3/4"	M55214	50	A-11	3,96
32-1"	M55013	100	A-9	3,96
32-1 1/4"	M55215	50	A-11	3,96
32-1 1/2"	M55337	50	A-11	3,90
40-1"	M55216	50	A-9	5,28
40-1 1/4"	M55338	100	A-4	6,12
40-1 1/2"	M55014	100	A-12	5,28
40-2"	M55339	100	A-4	6,12
50-1 1/4"	M55303	25	A-4	6,91
50-1 1/2"	M55001	25	A-8	7,04
50-2"	M55340	25	A-8	8,93
63-1 1/2"	M55341	25	A-4	10,47
63-2"	M55002	25	A-4	10,68
75-2 1/2"	M55015	5	A-11	18,82
90-3"	M55016	5	A-9	30,47
110-4"	M55192	2	A-11	66,38

Enlace mixto rosca macho.



J-79

Medida	Ref.	U/	n.º	€
25-3/4"	M55230	10	A-10	6,00
32-1"	M55231	10	A-1	9,00

Manguito pasamuros.



J-62

SIN REFUERZO METALICO

Medida	Ref.	U/	n.º	€
16-1/2"	M55152	50	A-10	1,75
20-1/2"	M55035	100	A-2	2,42
20-3/4"	M55687	50	A-1	2,37
20-1"	M55342	100	A-2	2,37
25-1/2"	M55134	50	A-2	3,06
25-3/4"	M55036	100	A-11	3,06
25-1"	M55246	50	A-2	3,06
32-3/4"	M55320	50	A-11	3,97
32-1"	M55037	100	A-9	4,05
32-1 1/4"	M55321	50	A-11	3,97
40-1"	M55322	50	A-9	5,46
40-1 1/4"	M55038	50	A-8	5,57
40-1 1/2"	M55343	50	A-8	5,46
50-1 1/4"	M55323	25	A-8	7,50
50-1 1/2"	M55005	25	A-8	7,50
50-2"	M55344	25	A-8	7,67
63-2"	M55006	25	A-4	11,39

J-62

CON REFUERZO METALICO

Medida	Ref.	U/	n.º	€
20-1/2"	M55169	100	A-2	2,91
20-3/4"	M55345	50	A-1	2,85
25-1/2"	M55170	50	A-2	3,62
25-3/4"	M55171	100	A-11	3,62
25-1"	M55247	50	A-2	3,62
32-3/4"	M55347	50	A-11	4,59
32-1"	M55172	100	A-9	4,69
32-1 1/4"	M55348	50	A-11	4,59
40-1"	M55349	50	A-8	6,39
40-1 1/4"	M55173	50	A-8	6,52
40-1 1/2"	M55350	50	A-8	6,52
50-1 1/4"	M55351	25	A-8	9,02
50-1 1/2"	M55174	25	A-8	9,20
50-2"	M55352	25	A-8	10,10
63-2"	M55144	25	A-4	13,49
75-2 1/2"	M55145	5	A-11	22,91
90-3"	M55146	5	A-8	35,01
110-4"	M55226	2	A-11	83,69

Enlace mixto rosca hembra.

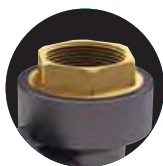

Sistema para unión de tuberías a presión Magnum 3G Fitting con inserto de latón



J-62



Medida	Ref.	U/	⊠ n.º	€
20-½"	M55710	50	A-2	14,74
25-¾"	M55711	60	A-11	17,28
32-1"	M55712	50	A-9	19,55
40-1 ¼"	M55713	25	A-2	26,65
50-1 ½"	M55714	12	A-2	32,78
63-2"	M55715	12	A-8	47,61

Enlace mixto rosca hembra con inserto de latón.

J-71



Medida	Ref.	U/	⊠ n.º	€
20-½"	M55723	25	A-2	23,81
25-¾"	M55724	25	A-2	25,91
32-1"	M55725	12	A-1	26,85
40-1 ¼"	M55726	15	A-11	26,85
50-1 ½"	M55727	10	A-11	32,83
63-2"	M55728	10	A-8	40,82

Enlace acodado 90° rosca hembra con inserto de latón.

J-61



Medida	Ref.	U/	⊠ n.º	€
20-½"	M55701	50	A-2	17,27
25-¾"	M55702	60	A-11	17,66
32-¾"	M55703	30	A-11	19,48
32-1"	M55704	50	A-9	19,48
32-1 ¼"	M55705	25	A-11	25,03
32-1 ½"	M55729	25	A-9	25,03
40-1"	M55706	25	A-8	25,16
40-1 ¼"	M55707	40	A-12	26,65
40-1 ½"	M55730	25	A-9	26,65
50-1 ¼"	M55731	12	A-2	32,78
50-1 ½"	M55708	12	A-2	32,78
63-2"	M55709	12	A-8	47,62

Enlace mixto rosca macho con inserto de latón.

J-69



Medida	Ref.	U/	⊠ n.º	€
20-½"	M55716	25	A-2	24,34
25-¾"	M55717	25	A-2	25,76
32-¾"	M55718	12	A-2	27,67
32-1"	M55719	12	A-2	27,67
40-1"	M55732	12	A-11	30,72
40-1 ¼"	M55720	15	A-11	32,18
40-1 ½"	M55733	15	A-11	32,18
50-1 ¼"	M55734	10	A-2	40,02
50-1 ½"	M55721	10	A-11	40,02
63-2"	M55722	10	A-8	56,64

Enlace acodado 90° rosca macho con inserto de latón.



FITTING UTC/PE

Para la conexión de tubería de PE Métrico a Cobre, PVC, ABS, Acero Inoxidable, Hierro Galvanizado y Plomo

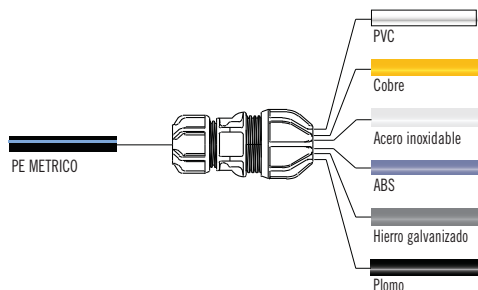

Conexión de PE con una gran variedad de tubos

PVC, cobre, hierro galvanizado, ABS, plomo, acero inoxidable, acero y polietileno.

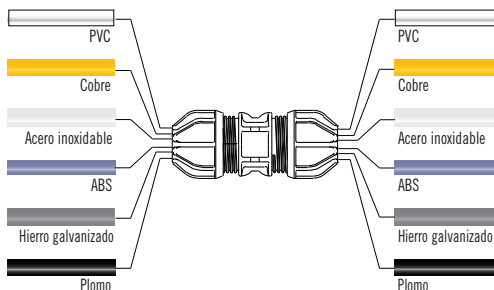

Conexión de una gran variedad de tubos entre sí

PVC, cobre, hierro galvanizado, ABS, plomo, acero inoxidable, acero y polietileno.

INSTALACIÓN RÁPIDA Y FÁCIL - Sistema desliza y aprieta

Completa seguridad

Accesorio premontado, sin riesgo de dañar las tuberías al montar.

Materiales de alto rendimiento

Fabricado con materiales termoplásticos tecnológicamente avanzados.

El Sistema UTC® está clasificado para una presión nominal de 12,5 bar a 20 ° C..

Cobertura completa

Conectando una amplia variedad de tuberías incluyendo Cobre, acero inoxidable, ABS, Hierro galvanizado y plomo.



WATER REGULATIONS ADVISORY SCHEME

WRAS Approval. (United Kingdom)
Cert. n.º: 1804340

MATERIALES Y COMPONENTES

CONEXIÓN TUBO PE

TUERCA - Acetal

CUERPO - Polipropileno

CASQUILLO PARTIDO - Acetal

JUNTA - Caucho nitrilo

CONEXIÓN UTC

TUERCA - Polipropileno
(34-39, 47-49 y 59-61 – Acetal)

CUERPO - Polipropileno

CASQUILLO PARTIDO - Acetal
con dientes de acero inoxidable

JUNTA - Caucho nitrilo

LUBRICANTE - Aceite de silicona

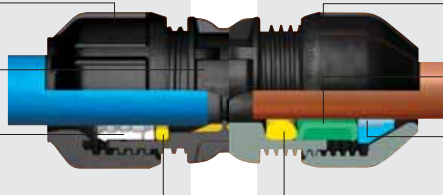



J-63

Medida	Ref.	U/	n.º	€
15-21x20	M55453	5	A-10	24,33
21-27x25	M55457	5	A-10	29,08
27-34x32	M55459	5	A-10	41,29
34-39x40	M55462	5	A-10	61,67
47-49x50	M55463	5	A-2	75,69
47-49x63	M55464	5	A-11	86,53
59-61x63	M55465	5	A-2	100,18

Enlace recto transición UTC/PE.



J-61

Medida	Ref.	U/	n.º	€
15-21x $\frac{3}{4}$ "	M55485	5	A-10	15,22
21-27x1"	M55488	5	A-10	20,68
27-34x1 $\frac{1}{2}$ "	M55493	5	A-10	31,62

Enlace mixto r/macho transición UTC/BSP



J-95

Medida	Ref.	U/	n.º	€
15-21x15-21	M55471	5	A-10	32,97
21-27x21-27	M55472	5	A-10	36,14
27-34x27-34	M55473	5	A-10	50,40
34-39x34-39	M55474	5	A-10	69,50
39-43x39-43	M55475	5	A-10	79,50
47-49x47-49	M55476	5	A-10	105,49
59-61x59-61	M55477	5	A-10	112,48

Enlace recto reparación UTC/UTC.



J-64

Medida	Ref.	U/	n.º	€
21-27x25	M55467	5	A-10	30,91
27-34x32	M55470	5	A-10	23,28

Enlace acodado transición UTC/PE.



J-68

Medida	Ref.	U/	n.º	€
21-27x15-21	M55478	5	A-10	36,46
27-34x21-27	M55480	5	A-10	50,88
39-43x27-34	M55482	5	A-2	69,03

Enlace reducido reparación UTC/UTC.



J-64

Medida	Ref.	U/	n.º	€
21-27x15-21	M55483	5	A-10	25,12
27-34x21-27	M55484	5	A-10	33,29

Enlace acodado UTC/UTC.



MAGNUM 3G

SERIE HCR Sistema para unión de tuberías a presión de alta resistencia a la corrosión.

- Sistema Fácil y rápido de instalar
- Seguro y Fiable
- Avanzado e innovador

Sistema MAGNUM 3G SERIE HCR

La nueva serie HCR Magnum 3G aporta una alternativa eficaz a materiales tradicionales en la instalación de acometidas para agua potable en edificación e infraestructura, donde materiales como el latón sufren corrosión y deterioro acelerado debido a los tratamientos para desinfección del agua potable.

Principales características y ventajas del sistema.

Los materiales de la serie HCR MAGNUM 3G están certificados ACS/ AENOR y son aptos para uso en aplicaciones para agua potable.

- Resistencia química.
- Resistencia a la corrosión y a la abrasión.
- Resistencia a la radiación UV.

Áreas de aplicación.

Los materiales tecnológicamente avanzados confieren al SISTEMA MAGNUM 3G características únicas siendo apto para agua potable y adecuado para el transporte de fluidos a presión en infraestructura, edificación e industria, con una fiabilidad total. 1.600Kpa (PN16) a 20°C + FOTOS o iconos de los segmentos.

Certificaciones / Certificações



ACS (Francia),
Fitting materials approved for use in drinking
water applications.XP P 41-280. Cert. nº: M3G
15 ACC LY 351 - M3G HCR 15 ACC LY 406.



J-62

Medida	Ref.	U/	U/bolsa	n.º	€
20-½"	HCR55035	100	10	A-2	5,00
20-¾"	HCR55687	50	10	A-1	5,00
25-½"	HCR55134	50	10	A-2	5,23
25-¾"	HCR55036	100	10	A-8	5,23
25-1"	HCR55246	50	10	A-2	5,23
32-¾"	HCR55320	50	5	A-11	7,38
32-1"	HCR55037	100	5	A-9	7,38
32-1 ¼"	HCR55321	50	5	A-11	8,91

Enlace mixto rosca hembra HCR.



J-61

Medida	Ref.	U/	U/bolsa	n.º	€
20-½"	HCR55011	100	10	A-2	4,88
20-¾"	HCR55132	50	10	A-1	4,88
25-1"	HCR55213	50	10	A-2	5,24
25-½"	HCR55133	100	10	A-2	5,24
25-¾"	HCR55012	50	10	A-8	5,24
32-¾"	HCR55214	50	5	A-11	6,79
32-1"	HCR55013	100	5	A-9	6,79
32-1 ¼"	HCR55215	50	5	A-11	9,94

Enlace mixto rosca macho HCR.



J-65

Medida	Ref.	U/	U/bolsa	n.º	€
25-¾"-25	HCR55024	100	10	A-2	36,18
32-¾"-32	HCR55244	50	5	A-9	44,82
32-1"-32	HCR55025	50	5	A-9	44,82

Te 90° rosca hembra HCR.



J-69

Medida	Ref.	U/	U/bolsa	n.º	€
25-¾"	HCR55097	50	10	A-2	11,66
25-1"	HCR55314	50	10	A-2	11,66
32-¾"	HCR55315	25	5	A-2	13,99
32-1"	HCR55098	25	5	A-2	13,99

Enlace acodado 90° rosca macho HCR.



J-67

Medida	Ref.	U/	U/bolsa	n.º	€
25-¾"	HCR55422	50	10	A-2	6,40
25-1"	HCR55423	50	10	A-2	6,92
32-¾"	HCR55424	25	5	A-2	7,06
32-1"	HCR55425	25	5	A-2	7,85

Enlace mixto rosca hembra, con tuerca loca HCR.



J-99

Medida	Ref.	U/	U/bolsa	n.º	€
25-¾"	HCR55413	50	10	A-2	18,47
25-1"	HCR55414	50	10	A-2	18,47
32-¾"	HCR55415	25	5	A-2	21,55
32-1"	HCR55416	25	5	A-2	21,55

Enlace acodado 90° rosca hembra, con tuerca loca HCR.



J-72

Medida	Ref.	U/	U/bolsa	n.º	€
25-¾"	HCR55077	50	10	A-11	35,10

Codo grifo 90° HCR.



Medida	Ref.	U/	n.º	€
20- $\frac{3}{4}$ "	52330	50	A-11	27,55
25- $\frac{3}{4}$ "	52331	50	A-11	28,62
32- $\frac{3}{4}$ "	52332	50	A-8	33,54

Válvula esfera para contador - HCR. Enlace fitting.



Medida	Ref.	U/	n.º	€
$\frac{1}{2}$ "- $\frac{3}{4}$ "	52333	50	A-11	26,91
$\frac{3}{4}$ "- $\frac{3}{4}$ "	52334	50	A-11	27,27
1"- $\frac{3}{4}$ "	52335	50	A-11	31,13

Válvula esfera para contador - HCR. Conexión rosca macho.



Medida	Ref.	U/	n.º	€
25- $\frac{3}{4}$ "	52336	50	A-11	38,46
32- $\frac{3}{4}$ "	52337	50	A-8	45,25

Válvula esfera ángulo para contador - HCR. Enlace fitting.



Medida	Ref.	U/	n.º	€
$\frac{3}{4}$ "- $\frac{3}{4}$ "	52338	50	A-11	27,27
1"- $\frac{3}{4}$ "	52339	50	A-11	31,13

Válvula esfera ángulo para contador - HCR. Conexión rosca macho.



Medida	Ref.	U/	n.º	€
16	M55157	50	4115	0,41
20	M55052	50	4115	0,48
25	M55053	50	4115	0,53
32	M55054	50	A-10	0,86
40	M55055	50	A-10	1,19
50	M55056	25	A-10	1,47
63	M55057	25	A-10	2,11

Junta de estanqueidad Magnum 3G y Magnum 3G-HCR.



Medida	Ref.	U/	n.º	€
20	M55400	50	A-2	0,46
25	M55401	50	A-2	0,52
32	M55402	50	A-2	0,84
40	M55403	50	A-2	1,17
50	M55056	25	A-10	1,47
63	M55057	25	A-10	2,11

Junta de estanqueidad accesorios reparaciones Magnum 3G.



Medida	Ref.	U/	n.º	€
16	M55232	50	A-10	0,51
20	M55233	50	A-10	0,54
25	M55234	50	A-1	0,58
32	M55235	50	A-2	0,93
40	M55236	50	A-11	1,57
50	M55237	25	A-11	2,54
63	M55238	25	A-8	4,40

Racor Magnum 3G.



Medida	Ref.	U/	n.º	€
20	HCR55233	50	A-10	0,70
25	HCR55234	50	A-10	0,84
32	HCR55235	50	A-2	1,06

Racor Magnum 3G - HCR.



Medida	Ref.	U/	n.º	€
20	HCR55046	50	A-10	0,48
25	HCR55047	50	A-10	0,65
32	HCR55048	50	A-10	0,76

Casquillo partido Magnum 3G - HCR.



Medida	Ref.	U/	n.º	€
16	M55156	50	A-10	0,41
20	M55046	50	A-10	0,48
25	M55047	50	A-10	0,65
32	M55048	50	A-10	0,76
40	M55049	50	A-10	0,87
50	M55050	25	A-10	1,21
63	M55051	25	A-1	1,32
75	M55064	15	A-1	11,63
90	M55065	15	A-2	15,31
110	M55168	15	A-2	22,77

Casquillo partido Magnum 3G.

Medida	Ref.	U/	n.º	€
20	M55406	20	A-10	2,98
25	M55407	20	A-10	3,02
32	M55408	20	A-10	3,89
40	M55409	10	A-10	4,38
50	M55410	10	A-10	5,53
63	M55411	10	A-1	9,44

Casquillo partido Magnum 3G especial tubo PVC.

Medida	Ref.	U/	n.º	€
75	M55450	15	A-1	8,47
90	M55451	15	A-2	10,01
110	M55452	15	A-2	12,02

Kit junta de estanqueidad y arandela.



Medida	Ref.	U/	n.º	€
16-32	55248	20	A-10	32,92
40-63	55249	20	A-2	46,26
75-110	55250	10	A-8	91,92

Llave de apriete fitting Gama'55.

Medida	Ref.	U/	n.º	€
75	M55441	10	A-2	26,28
90	M55442	10	A-2	31,31
110	M55443	10	A-2	45,53

Kit junta de estanqueidad, casquillo partido, arandela y racor.



J-93

Medida	Ref.	U/	n.º	€
16 a 63	55690	10	A-2	18,41

Llave de apriete fitting universal.

Accesorios manipulados de Polietileno

INFRAESTRUCTURA





Accesorios manipulados en taller a partir de tubo de Polietileno PE100 fabricado bajo norma UNE-EN-12201-2 y valonas. En este apartado se detallan las figuras más habituales. Para otras figuras (colectores, tomas embridadas etc), consultar. En los codos y tés no se ha tenido en cuenta el coeficiente de reducción de la norma UNE-EN-12201-3. En caso de requerirlo consultar con la red comercial.

Podemos realizar piezas o proyectos a medida según necesidades específicas. Solicite presupuesto sin compromiso.

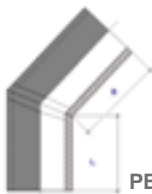

PE 100 SDR 11 CODOS 30°

Ref.	Ø	€/Ud.
089280030160	280	148,37
089315030160	315	207,53
089355030160	355	269,87
089400030160	400	351,68
089450030160	450	476,47
089500030160	500	632,25
089560030160	560	857,91
089630030160	630	1.148,87

PE 100 SDR 17 CODOS 30°

Ref.	Ø	€/Ud.
089280030100	280	100,61
089315030100	315	140,79
089355030100	355	183,45
089400030100	400	238,23
089450030100	450	322,77
089500030100	500	428,70
089560030100	560	582,28
089630030100	630	778,62
089710030100	710	1.086,21
089800030100	800	1.431,92
089900030100	900	CONSULTAR
089100030100	1000	CONSULTAR



PE 100 SDR 11 CODOS 45°

Ref.	Ø	€/Ud.
089280045160	280	210,97
089315045160	315	288,28
089355045160	355	378,32
089400045160	400	497,25
089450045160	450	664,89
089500045160	500	878,12
089560045160	560	1.173,58
089630045160	630	1.573,14

PE 100 SDR 17 CODOS 45°

Ref.	Ø	€/Ud.
089280045100	280	143,04
089315045100	315	195,56
089355045100	355	257,15
089400045100	400	336,86
089450045100	450	450,40
089500045100	500	595,42
089560045100	560	796,52
089630045100	630	1.066,17
089710045100	710	1.494,08
089800045100	800	1.967,61
089900045100	900	CONSULTAR
089100045100	1000	CONSULTAR



PE 100 SDR 11 CODOS 60°

Ref.	Ø	€/Ud.
089280060160	280	246,96
089315060160	315	335,20
089355060160	355	444,20
089400060160	400	588,58
089450060160	450	784,93
089500060160	500	1.039,16
089560060160	560	1.383,03
089630060160	630	1.862,17

PE 100 SDR 17 CODOS 60°

Ref.	Ø	€/Ud.
089280060100	280	167,45
089315060100	315	227,40
089355060100	355	301,94
089400060100	400	398,73
089450060100	450	531,72
089500060100	500	704,63
089560060100	560	938,68
089630060100	630	1.262,06
089710060100	710	1.815,54
089800060100	800	2.377,19
089900060100	900	CONSULTAR
089100060100	1000	CONSULTAR

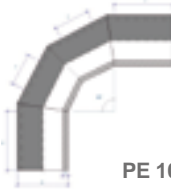

PE 100 SDR 11 CODOS 90°

Ref.	Ø	€/Ud.
089280090160	280	271,13
089315090160	315	365,79
089355090160	355	483,07
089400090160	400	637,89
089450090160	450	847,37
089500090160	500	1.116,27
089560090160	560	1.479,57
089630090160	630	1.984,57

PE 100 SDR 17 CODOS 90°

Ref.	Ø	€/Ud.
089280090100	280	183,84
089315090100	315	248,16
089355090100	355	328,36
089400090100	400	432,14
089450090100	450	574,02
089500090100	500	756,91
089560090100	560	1.004,20
089630090100	630	1.345,02
089710090100	710	1.851,80
089800090100	800	2.431,61
089900090100	900	CONSULTAR
089100090100	1000	CONSULTAR



PE 100 SDR 11 TES IGUALES

Ref.	Ø	€/Ud.
100280000160	280	284,18
100315000160	315	324,85
100355000160	355	456,75
100400000160	400	691,62
100450000160	450	875,69
100500000160	500	1.139,55
100560000160	560	1.609,59
100630000160	630	2.087,02

PE 100 SDR 17 TES IGUALES

Ref.	Ø	€/Ud.
100280000100	280	174,07
100315000100	315	243,95
100355000100	355	310,48
100400000100	400	468,54
100450000100	450	593,20
100500000100	500	772,70
100560000100	560	1.092,45
100630000100	630	1.414,45
100710000100	710	CONSULTAR
100800000100	800	CONSULTAR
100900000100	900	CONSULTAR
100100000100	1000	CONSULTAR

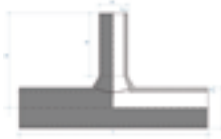

PE 100 SDR 11 TES REDUCIDAS

Ref.	Ø	€/Ud.
105075063160	75/63	CONSULTAR
105090063160	90/63	CONSULTAR
105090075160	90/75	CONSULTAR
105110063160	110/63	CONSULTAR
105110075160	110/75	CONSULTAR
105110090160	110/90	CONSULTAR
105125063160	125/63	CONSULTAR
105125075160	125/75	CONSULTAR
105125090160	125/90	CONSULTAR
105125090160	125/110	CONSULTAR
105140063160	140/63	51,63
105140075160	140/75	55,89
105140090160	140/90	62,60
105140110160	140/110	73,10
105140125160	140/125	127,13
105160063160	160/63	64,47
105160075160	160/75	68,71
105160090160	160/90	75,42
105160110160	160/110	85,91
105160125160	160/125	95,47
105160140160	160/140	142,03
105180063160	180/63	78,65
105180075160	180/75	82,91
105180090160	180/90	89,62
105180110160	180/110	100,10
105180125160	180/125	109,66
105180140160	180/140	119,93
105180160160	180/160	252,46
105200063160	200/63	94,50
105200075160	200/75	98,76

Ref.	Ø	€/Ud.
105200090160	200/90	105,47
105200110160	200/110	115,96
105200125160	200/125	125,51
105200140160	200/140	135,77
105200160160	200/160	152,05
105200180160	200/180	281,85
105225063160	225/63	116,69
105225075160	225/75	120,93
105225090160	225/90	127,64
105225110160	225/110	138,13
105225125160	225/125	147,69
105225140160	225/140	157,96
105225160160	225/160	174,23
105225180160	225/180	192,25
105225200160	225/200	318,60
105250063160	250/63	141,15
105250075160	250/75	145,38
105250090160	250/90	152,10
105250110160	250/110	162,59
105250125160	250/125	172,15
105250140160	250/140	182,41
105250160160	250/160	198,68
105250180160	250/180	216,70
105250200160	250/200	236,82
105250225160	250/225	377,73
105280063160	280/63	177,85
105280075160	280/75	182,09
105280090160	280/90	188,82
105280110160	280/110	199,30
105280125160	280/125	208,86

Ref.	Ø	€/Ud.
105280140160	280/140	219,13
105280160160	280/160	235,40
105280180160	280/180	253,41
105280200160	280/200	273,53
105280225160	280/225	301,68
105280250160	280/250	462,39
105315063160	315/63	225,31
105315075160	315/75	229,55
105315090160	315/90	236,26
105315110160	315/110	246,75
105315125160	315/125	256,31
105315140160	315/140	266,57
105315160160	315/160	282,84
105315180160	315/180	300,86
105315200160	315/200	320,98
105315225160	315/225	349,12
105315250160	315/250	380,16
105315280160	315/280	519,24
105355063160	355/63	293,10
105355075160	355/75	297,35
105355090160	355/90	304,05
105355110160	355/110	314,56
105355125160	355/125	324,10
105355140160	355/140	334,37
105355160160	355/160	350,65
105355180160	355/180	368,65
105355200160	355/200	388,77
105355225160	355/225	416,92
105355250160	355/250	449,61
105355280160	355/280	492,95
105355315160	355/315	557,95
105400063160	400/63	369,06
105400075160	400/75	373,29
105400090160	400/90	380,01
105400110160	400/110	390,50
105400125160	400/125	400,06
105400140160	400/140	410,32
105400160160	400/160	426,60
105400180160	400/180	444,62
105400200160	400/200	464,72
105400225160	400/225	492,88
105400250160	400/250	525,56
105400280160	400/280	568,91
105400315160	400/315	633,91
105400355160	400/355	1.168,74
105450063160	450/63	464,43
105450075160	450/75	468,67
105450090160	450/90	475,39
105450110160	450/110	485,88
105450125160	450/125	495,44
105450140160	450/140	505,70
105450160160	450/160	521,97
105450180160	450/180	539,99
105450200160	450/200	560,10
105450225160	450/225	588,26
105450250160	450/250	620,94

Ref.	Ø	€/Ud.
105450280160	450/280	664,28
105450315160	450/315	729,27
105450355160	450/355	1.229,51
105450400160	450/400	1.291,58
105500063160	500/63	629,29
105500075160	500/75	633,51
105500090160	500/90	640,23
105500110160	500/110	650,73
105500125160	500/125	660,29
105500140160	500/140	670,55
105500160160	500/160	686,82
105500180160	500/180	704,84
105500200160	500/200	724,96
105500225160	500/225	753,09
105500250160	500/250	785,80
105500280160	500/280	829,14
105500315160	500/315	894,14
105500355160	500/355	2.274,92
105500400160	500/400	2.360,50
105500450160	500/450	1.829,83
105560063160	560/63	858,33
105560075160	560/75	862,57
105560090160	560/90	869,29
105560110160	560/110	879,77
105560125160	560/125	889,33
105560140160	560/140	899,60
105560160160	560/160	915,88
105560180160	560/180	933,89
105560200160	560/200	954,00
105560225160	560/225	982,15
105560250160	560/250	1.014,85
105560280160	560/280	1.058,18
105560315160	560/315	1.123,18
105560355160	560/355	2.521,68
105560400160	560/400	2.607,26
105560450160	560/450	2.076,59
105560500160	560/500	2.185,85
105630063160	630/63	1.178,02
105630075160	630/75	1.182,25
105630090160	630/90	1.188,97
105630110160	630/110	1.199,46
105630125160	630/125	1.209,02
105630140160	630/140	1.219,28
105630160160	630/160	1.235,55
105630180160	630/180	1.253,58
105630200160	630/200	1.273,68
105630225160	630/225	1.301,84
105630250160	630/250	1.334,52
105630280160	630/280	1.377,87
105630315160	630/315	1.442,87
105630355160	630/355	3.598,18
105630400160	630/400	3.671,23
105630450160	630/450	3.124,83
105630500160	630/500	2.529,11
105630560160	630/560	2.655,52



PE 100 SDR 17 TES REDUCIDAS

Ref.	Ø	€/Ud.
105250063100	250/63	95,56
105250075100	250/75	98,57
105250090100	250/90	103,09
105250110100	250/110	110,33
105250125100	250/125	116,41
105250140100	250/140	123,62
105250160100	250/160	134,44
105250180100	250/180	146,65
105250200100	250/200	160,28
105250225100	250/225	296,71
105280063100	280/63	120,65
105280075100	280/75	123,66
105280090100	280/90	128,18
105280110100	280/110	135,41
105280125100	280/125	141,50
105280140100	280/140	148,71
105280160100	280/160	159,51
105280180100	280/180	171,73
105280200100	280/200	185,37
105280225100	280/225	204,75
105280250100	280/250	354,02
105315063100	315/63	152,89
105315075100	315/75	155,90
105315090100	315/90	160,42
105315110100	315/110	167,66
105315125100	315/125	173,75
105315140100	315/140	180,97
105315160100	315/160	191,77
105315180100	315/180	204,00
105315200100	315/200	217,61
105315225100	315/225	237,00
105315250100	315/250	257,60
105315280100	315/280	392,86
105355063100	355/63	199,26
105355075100	355/75	202,29
105355090100	355/90	206,78
105355110100	355/110	214,03
105355125100	355/125	220,11
105355140100	355/140	227,33
105355160100	355/160	238,13
105355180100	355/180	250,36
105355200100	355/200	263,98
105355225100	355/225	283,36
105355250100	355/250	305,08
105355280100	355/280	957,47
105355315100	355/315	808,46
105400063100	400/63	250,07
105400075100	400/75	253,08
105400090100	400/90	257,60

Ref.	Ø	€/Ud.
105400110100	400/110	264,84
105400125100	400/125	270,92
105400140100	400/140	278,14
105400160100	400/160	288,95
105400180100	400/180	301,17
105400200100	400/200	314,79
105400225100	400/225	334,18
105400250100	400/250	355,90
105400280100	400/280	385,53
105400315100	400/315	429,70
105400355100	400/355	930,44
105450063100	450/63	314,68
105450075100	450/75	317,68
105450090100	450/90	322,20
105450110100	450/110	329,44
105450125100	450/125	335,52
105450140100	450/140	342,74
105450160100	450/160	353,54
105450180100	450/180	365,76
105450200100	450/200	379,39
105450225100	450/225	398,78
105450250100	450/250	420,49
105450280100	450/280	450,14
105450315100	450/315	494,30
105450355100	450/355	971,48
105450400100	450/400	1.013,02
105500063100	500/63	426,75
105500075100	500/75	429,76
105500090100	500/90	434,28
105500110100	500/110	441,52
105500125100	500/125	447,60
105500140100	500/140	454,81
105500160100	500/160	465,62
105500180100	500/180	477,84
105500200100	500/200	491,47
105500225100	500/225	510,86
105500250100	500/250	532,57
105500280100	500/280	562,21
105500315100	500/315	606,37
105500355100	500/355	1.862,96
105500400100	500/400	1.920,24
105500450100	500/450	1.422,64
105560063100	560/63	582,60
105560075100	560/75	585,62
105560090100	560/90	590,13
105560110100	560/110	597,36
105560125100	560/125	603,46
105560140100	560/140	610,67
105560160100	560/160	621,48

Ref.	Ø	€/Ud.
105560180100	560/180	633,69
105560200100	560/200	647,32
105560225100	560/225	666,70
105560250100	560/250	688,43
105560280100	560/280	718,06
105560315100	560/315	762,23
105560355100	560/355	2.030,88
105560400100	560/400	2.088,15
105560450100	560/450	1.590,58
105560500100	560/500	1.727,55
105630063100	630/63	798,43
105630075100	630/75	801,44
105630090100	630/90	805,96
105630110100	630/110	813,19
105630125100	630/125	819,28
105630140100	630/140	826,50
105630160100	630/160	837,30
105630180100	630/180	849,53
105630200100	630/200	863,14
105630225100	630/225	882,53
105630250100	630/250	904,25
105630280100	630/280	933,89
105630315100	630/315	978,06
105630355100	630/355	2.941,84
105630400100	630/400	2.990,74
105630450100	630/450	2.482,49
105630500100	630/500	1.896,61
105630560100	630/560	1.982,71
105710063100	710/63	1.058,61
105710075100	710/75	1.059,71
105710090100	710/90	1.064,30
105710110100	710/110	1.071,66
105710125100	710/125	1.077,85
105710140100	710/140	1.085,18
105710160100	710/160	1.096,17
105710180100	710/180	1.108,59
105710200100	710/200	1.122,45
105710225100	710/225	1.142,16
105710250100	710/250	1.164,33
105710280100	710/280	1.194,55
105710315100	710/315	1.239,98
105710355100	710/355	1.306,91
105710400100	710/400	1.357,32
105710450100	710/450	1.327,35
105710500100	710/500	1.455,97
105710560100	710/560	1.545,67
105710630100	710/630	2.327,30
105800063100	800/63	1.305,38
105800075100	800/75	1.306,47
105800090100	800/90	1.311,07
105800110100	800/110	1.318,43
105800125100	800/125	1.324,61
105800140100	800/140	1.331,95
105800160100	800/160	1.342,93
105800180100	800/180	1.355,36

Ref.	Ø	€/Ud.
105800200100	800/200	1.369,22
105800225100	800/225	1.388,92
105800250100	800/250	1.411,11
105800280100	800/280	1.441,31
105800315100	800/315	1.486,75
105800355100	800/355	1.553,67
105800400100	800/400	1.604,08
105800450100	800/450	1.574,11
105800500100	800/500	1.702,76
105800560100	800/560	1.792,44
105800630100	800/630	2.468,21
105800710100	800/710	2.363,57
105900063100	900/63	CONSULTAR
105900075100	900/75	CONSULTAR
105900090100	900/90	CONSULTAR
105900110100	900/110	CONSULTAR
105900125100	900/125	CONSULTAR
105900160100	900/160	CONSULTAR
105900180100	900/180	CONSULTAR
105900200100	900/200	CONSULTAR
105900225100	900/225	CONSULTAR
105900250100	900/250	CONSULTAR
105900280100	900/280	CONSULTAR
105900315100	900/315	CONSULTAR
105900355100	900/355	CONSULTAR
105900400100	900/400	CONSULTAR
105900450100	900/450	CONSULTAR
105900500100	900/500	CONSULTAR
105900560100	900/560	CONSULTAR
105900630100	900/630	CONSULTAR
105900710100	900/710	CONSULTAR
105900800100	900/800	CONSULTAR
105100063100	1000/63	CONSULTAR
105100075100	1000/75	CONSULTAR
105100090100	1000/90	CONSULTAR
105100110100	1000/110	CONSULTAR
105100125100	1000/125	CONSULTAR
105100160100	1000/160	CONSULTAR
105100180100	1000/180	CONSULTAR
105100200100	1000/200	CONSULTAR
105100225100	1000/225	CONSULTAR
105100250100	1000/250	CONSULTAR
105100280100	1000/280	CONSULTAR
105100315100	1000/315	CONSULTAR
105100355100	1000/355	CONSULTAR
105100400100	1000/400	CONSULTAR
105100450100	1000/450	CONSULTAR
105100500100	1000/500	CONSULTAR
105100560100	1000/560	CONSULTAR
105100630100	1000/630	CONSULTAR
105100710100	1000/710	CONSULTAR
105100800100	1000/800	CONSULTAR
105100900100	1000/900	CONSULTAR



PE 100 SDR 11 REDUCCIONES

Ref.	Ø	€/Ud.
110225160160	225/160	327,04
110225180160	225/180	213,24
110225200160	225/200	225,36
110250180160	250/180	397,21
110250225160	250/225	269,50
110280200160	280/200	425,67
110280225160	280/225	280,56
110280250160	280/250	328,91
110315225160	315/225	433,00
110315250160	315/250	328,39
110315280160	315/280	356,31
110355250160	355/250	892,97
110355280160	355/280	931,87
110355315160	355/315	773,62
110400280160	400/280	960,53
110400315160	400/315	802,27
110400355160	400/355	899,37
110450315160	450/315	1.302,22
110450355160	450/355	890,24
110450400160	450/400	954,94
110500355160	500/355	1.819,88
110500400160	500/400	1.908,10
110500450160	500/450	1.380,73
110560400160	560/400	1.972,38
110560450160	560/450	1.445,00
110560500160	560/500	1.557,97
110630450160	630/450	1.459,12
110630500160	630/500	1.646,93
110630560160	630/560	1.778,24

PE 100 SDR 17 REDUCCIONES

Ref.	Ø	€/Ud.
110225160100	225/160	282,05
110225180100	225/180	174,71
110225200100	225/200	182,93
110250180100	250/180	340,02
110250225100	250/225	223,49
110280200100	280/200	359,37
110280225100	280/225	231,04
110280250100	280/250	263,52
110315225100	315/225	375,08
110315250100	315/250	263,22
110315280100	315/280	282,30
110355250100	355/250	783,86
110355280100	355/280	810,46
110355315100	355/315	662,54
110400280100	400/280	829,66
110400315100	400/315	681,74
110400355100	400/355	747,97
110450315100	450/315	1.183,34
110450355100	450/355	741,68
110450400100	450/400	784,99
110500355100	500/355	1.554,42
110500400100	500/400	1.613,47
110500450100	500/450	1.118,12
110560400100	560/400	1.657,23
110560450100	560/450	1.161,90
110560500100	560/500	1.301,39
110630450100	630/450	1.882,10
110630500100	630/500	1.298,74
110630560100	630/560	1.388,17
110710500100	710/500	CONSULTAR
110710560100	710/560	CONSULTAR
110710630100	710/630	CONSULTAR
110800560100	800/560	CONSULTAR
110800630100	800/630	CONSULTAR
110800710100	800/710	CONSULTAR
110900630100	900/630	CONSULTAR
110900710100	900/710	CONSULTAR
110900800100	900/800	CONSULTAR
110100710100	1000/710	CONSULTAR
110100800100	1000/800	CONSULTAR
110100900100	1000/900	CONSULTAR



PE 100 SDR 11 TAPONES

Ref.	Ø	€/Ud.
138280000160	280	141,45
138315000160	315	176,81
138355000160	355	235,75
138400000160	400	294,69
138450000160	450	353,63
138500000160	500	412,57
138560000160	560	471,50
138630000160	630	530,45

PE 100 SDR 17 TAPONES

Ref.	Ø	€/Ud.
138280000100	280	100,20
138315000100	315	123,77
138355000100	355	165,02
138400000100	400	212,18
138450000100	450	253,44
138500000100	500	294,69
138560000100	560	335,95
138630000100	630	377,20
138710000100	710	CONSULTAR
138800000100	800	CONSULTAR

Bridas, portabridas, pasamuros y juntas

INFRAESTRUCTURA





BRIDAS DE ACERO CINCADO PN10 (DIN 2576) MOP 10 BAR

Ref.	PN	Ø Tubo	DN	Nº Agujeros	€/Ud
311050016055	10/16	50	40	4	10,25
311063016055	10/16	63	50	4	11,94
311075016055	10/16	75	65	4	14,61
311090016055	10/16	90	80	8	18,78
311110016055	10/16	110	100	8	20,31
311125016055	10/16	125	125	8	27,31
311140016055	10/16	140	125	8	22,92
311160016055	10/16	160	150	8	34,47
311180016055*	10/16	180	150	8	43,02
311200010055	10	200	200	8	47,52
311225010055*	10	225	200	8	61,67
311250010055	10	250	250	12	49,59
311280010055*	10	280	250	12	77,22
311315010055	10	315	300	12	63,86
311355010055	10	355	350	16	86,77
311400010055	10	400	400	16	121,37
311450010055*	10	450	450	20	Consultar
311500010155*	10	450-500	500	20	268,04
311500010055	10	500	500	20	173,56
311560010055*	10	560	600	20	336,12
311630010055	10	630	600	20	226,61
311710010055*	10	710	700	24	437,21
311800010055*	10	800	800	24	582,58
311900010055*	10	900	900	28	698,41
311100010055*	10	1000	1000	28	891,26

* Galvanizadas

BRIDAS DE ACERO CINCADO PN16 (DIN 2502) MOP 16 BAR

Ref.	PN	Ø Tubo	DN	Nº Agujeros	€/Ud
311200016055	16	200	200	12	46,72
311225016055*	16	225	200	12	59,41
311250016055	16	250	250	12	62,16
311280016055*	16	280	250	12	84,11
311315016055	16	315	300	12	81,08
311355016055	16	355	350	16	117,22
311400016055	16	400	400	16	147,28
311450016055*	16	450	450	20	Consultar
311500016155*	16	450-500	500	20	363,25
311500016055	16	500	500	20	292,05
311560016055*	16	560	600	20	571,30
311630016055	16	630	600	20	395,07
311710016055*	16	710	700	24	568,73
311800016055*	16	800	800	24	721,58
311900016055*	16	900	900	28	857,44
311100016055*	16	1000	1000	28	1.143,47

* Galvanizadas



**BRIDAS CIEGAS DE ACERO CINCADO
PN10 (DIN 2527) MOP 10/16 Y 10 BAR**

Ref.	DN Brida	PN	Nº Agujeros	€/Ud
312015010055	1/2" 15	10/16	4	4,61
312020010055	3/4" 20	10/16	4	6,50
312025010055	1 " 25	10/16	4	7,88
312032010055	1 1/4" 32	10/16	4	10,28
312040010055	1 1/2" 40	10/16	4	11,92
312050010055	2" 50	10/16	4	16,41
312065010055	2 1/2" 65	10/16	4	20,37
312080010055	3 " 80	10/16	4	26,54
312100010055	4 " 100	10/16	8	31,44
312125010055	5" 125	10/16	8	47,20
312150010055	6" 150	10/16	8	57,88
312200010055	8" 200	10	8	91,77
312250010055	10" 250	10	12	133,53
312300010055	12" 300	10	12	171,85
312350010055	14" 350	10	16	224,25
312400010055	16" 400	10	16	275,19
312450010055	18" 450	10	20	350,21
312500010055	20" 500	10	20	417,16
312600010055	24" 600	10	20	609,20

**BRIDAS CIEGAS DE ACERO CINCADO
PN16 (DIN 2527) MOP 16 BAR**

Ref.	DN Brida	PN	Nº Agujeros	€/Ud
312200016055	8" 200	16	12	88,69
312250016055	10" 250	16	12	136,90
312300016055	12" 300	16	12	192,49
312350016055	14" 350	16	16	261,68
312400016055	16" 400	16	16	347,93
312450016055	18" 450	16	20	476,55
312500016055	20" 500	16	20	558,79
312600016055	24" 600	16	20	780,70

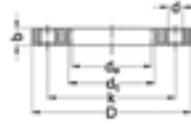

QDMPE - BRIDA DE ACERO RECUBIERTA DE PP (DIN 2501) MOP 10/16 BAR

Ver página 370

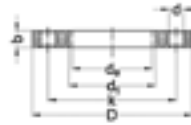

QDMPE - BRIDA DE ACERO RECUBIERTA DE PP (DIN 2501) MOP 10 BAR

Ver página 370

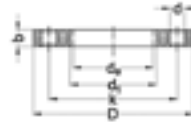

QDMPE - BRIDA DE ACERO RECUBIERTA DE PP (DIN 2501) MOP 16 BAR

Ver página 370



**PORTABRIDAS INYECTADO
CUELLO LARGO SDR 11**

*Máxima presión de trabajo permitida
16 bar (agua) / 10 bar (gas)*

Ref.	Ø	€/Ud
4013025	25	2,54
4013032	32	3,22
4013040	40	3,45
4013050	50	3,88
4013063	63	4,20
4013075	75	5,54
4013090	90	7,12
4013110	110	9,64
4013125	125	11,83
4013140	140	17,50
4013160	160	20,25
4013180	180	24,09
4013200	200	35,59
4013225	225	38,01
4013250	250	69,11
4013280	280	88,65
4013315	315	105,03
4013355	355	207,61
4013400	400	322,92
4013450	450	376,79
4013500	500	418,65
4013560	560	Consultar
4013630	630	Consultar

**PORTABRIDAS INYECTADO
CUELLO LARGO SDR 17**

*Máxima presión de trabajo permitida
10 bar (agua) / 5 bar (gas)*

Ref.	Ø	€/Ud
4013050010	50	6,36
4013063010	63	8,60
4013075010	75	10,09
4013090010	90	6,40
4013110010	110	9,13
4013125010	125	11,03
4013140010	140	16,28
4013160010	160	18,76
4013180010	180	22,00
4013200010	200	26,88
4013225010	225	35,02
4013250010	250	71,92
4013280010	280	84,75
4013315010	315	107,51
4013355010	355	169,46
4013400010	400	312,29
4013450010	450	375,89
4013500010	500	418,65
4013560010	560	531,62
4013630010	630	680,63



PORTABRIDAS MANIPULADO SDR 11

Máxima presión de trabajo permitida 16 bar (agua)

Ref.	Ø	€/Ud
136280000160	280	175,36
136315000160	315	238,50
136355000160	355	373,30
136400000160	400	475,17
136450000160	450	758,42
136500000160	500	772,22
136560000160	560	1.091,68
136630000160	630	1.138,36

PORTABRIDAS MANIPULADO SDR 17

Máxima presión de trabajo permitida 10 bar (agua)

Ref.	Ø	€/Ud
136280000100	280	119,82
136315000100	315	163,45
136355000100	355	253,12
136400000100	400	326,76
136450000100	450	522,65
136500000100	500	541,83
136560000100	560	795,51
136630000100	630	790,63
136710000100	710	1.175,86
136800000100	800	1.486,80
136900000100	900	Consultar
136100000100	1000	Consultar



QBE - PORTABRIDAS CORTOS PE 100 SDR 11

Máxima presión de trabajo permitida 16 bar (agua) / 10 bar (gas)

Ref.	Ø	€/Ud
QBE11020	20	2,10
QBE11025	25	2,10
QBE11032	32	2,48
QBE11040	40	2,99
QBE11050	50	3,66
QBE11063	63	4,54
QBE11075	75	5,40
QBE11090	90	7,70
QBE11110	110	9,94
QBE11125	125	11,99
QBE11140	140	13,99
QBE11160	160	17,66
QBE11180	180	27,39
QBE11200	200	30,19
QBE11225	225	33,62
QBE11250	250	51,04
QBE11280	280	55,73
QBE11315	315	65,66
QBE11355	355	176,61
QBE11400	400	218,72
QBE11450	450	408,16
QBE11500	500	341,50
QBE11560	560	528,27
QBE11630	630	448,20
QBE11710	710	686,01
QBE11800	800	946,05

QBE - PORTABRIDAS CORTOS PE 100 SDR 17

Máxima presión de trabajo permitida 10 bar (agua) / 5 bar (gas)

Ref.	Ø	€/Ud
QBE17050	50	3,32
QBE17063	63	4,07
QBE17075	75	4,85
QBE17090	90	7,10
QBE17110	110	8,99
QBE17125	125	11,02
QBE17140	140	12,82
QBE17160	160	15,89
QBE17180	180	23,21
QBE17200	200	29,02
QBE17225	225	32,49
QBE17250	250	46,46
QBE17280	280	45,73
QBE17315	315	62,68
QBE17355	355	117,37
QBE17400	400	152,33
QBE17450	450	284,15
QBE17500	500	250,81
QBE17560	560	405,55
QBE17630	630	320,18
QBE17710	710	548,81
QBE17800	800	701,25
QBE17900	900	838,46
QBE171000	1000	1.301,72



PASAMUROS DE PE

Con extremo liso & brida según EN1092 PN10

Ref.	DN	Ø	L	€/Ud
750310106	25	32	250	160,52
750410106	32	40	250	185,64
750510106	40	50	250	196,59
750610106	50	63	250	209,76
750710106	65	75	250	235,09
750910106	80	90	250	290,61
751110106	100	110	250	306,66
751210106	100	125	250	315,28
751310106	125	125	250	326,87
751410106	125	140	250	358,77
751610106	150	160	250	413,11
751810106	150	180	250	449,91
752010106	200	200	250	487,99
752210106	200	225	250	527,07
752510106	250	250	250	641,16
752810106	250	280	250	699,27
753110106	300	315	250	733,81
753410106	300	355	250	872,15
753510106	350	355	250	944,64
753910106	350	400	250	1.146,65
754010106	400	400	250	1.144,20
754410106	400	450	250	1.352,37
754510106	500	450	250	1.372,67
755010106	500	500	250	1.747,00
755410106	500	560	250	1.891,18
755610106	600	560	300	1.713,31
756310106	600	630	300	2.569,48
757110106	700	710	350	Consultar
758010106	800	800	350	Consultar
759010106	900	900	400	Consultar
759110106	1000	1000	400	Consultar

Junta central en EPDM, anclajes en acero cincado.
Extremo liso SDR 17 según 12201.
Para paredes con espesor = L.
Consultar alternativa en PN16.
Consultar longitudes extra.



PASAMUROS DE PE

Embridado según EN1092 PN10

Ref.	DN	Ø	L	€/Ud
750320106	25	32	250	219,48
750420106	32	40	250	296,29
750520106	40	50	250	427,65
750620106	50	63	250	344,94
750720106	65	75	250	402,89
750920106	80	90	250	458,04
751120106	100	110	250	504,75
751220106	100	125	250	518,79
751320106	125	125	250	531,25
751420106	125	140	250	589,64
751620106	150	160	250	689,33
751820106	150	180	250	728,41
752020106	200	200	250	791,34
752220106	200	225	250	851,21
752520106	250	250	250	1.064,29
752820106	250	280	250	1.133,90
753120106	300	315	250	1.221,15
753420106	300	355	250	1.425,57
753520106	350	355	250	1.531,40
753920106	350	400	250	1.882,68
754020106	400	400	250	1.938,39
754420106	400	450	250	2.142,75
754520106	500	450	250	2.665,16
755020106	500	500	250	2.899,59
755420106	500	560	250	3.218,99
755620106	600	560	300	3.020,61
756320106	600	630	300	4.271,11
757120106	700	710	350	Consultar
758020106	800	800	350	Consultar
759020106	900	900	400	Consultar
759120106	1000	1000	400	Consultar

Junta central en EPDM, anclajes en acero cincado
Extremo liso SDR 17 según 12201
Para paredes con espesor = L.
Consultar alternativa en PN16.

*Otras configuraciones: pasamuros en ángulo disponibles
previa consulta.*



JUNTAS YUNTAFLX

Ref.	Ø Tubo	DN Brida	Uds./caja	€/Ud
315020045535	20	15	50	1,49
315025055535	25	20	50	1,51
315030065535	32	25	50	1,58
315045085535	50	40	50	1,65
315055100535	63	50	50	1,77
315070120535	75	65	50	1,87
315085135535	90	80	50	2,15
315105155535	110	100	50	2,17
315135185535	125	125	50	2,40
315160210535	160	150	50	2,94
315210265535	200	200	50	3,94
315260320535	250	250	25	4,15
315310375535	315	300	15	6,52
315360435535	355	350	15	10,02
315410485535	400	400	15	10,42
315510610535	500	500	15	18,66
315610725535	630	600	15	24,86

Junta de plástico flexible, totalmente terminada que no requiere otra manipulación que la de su inmediata colocación entre bridas de unión de dos tubos durante su atornillado. Anticorrosivas, impermeables, imputrescibles e inalterables a la acción de la mayoría de los ácidos, aceites e hidrocarburos. Resistencia a la temperatura de hasta 60°C y presiones hasta 30 atmósferas. Sin desperdicios por recortes ni costes de mano de obra por manipulación. Se mantienen fijas con tan solo dos dedos durante el atornillado de las bridas entre sí. Duración ilimitada.

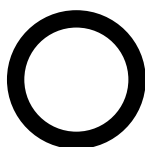

QPV-J

Ref.	Ø	€/FKM
QH VX020F	20	4,96
QH VX025F	25	4,96
QH VX032F	32	7,55
QH VX040F	40	10,53
QH VX050F	50	10,44
QH VX063F	63	17,59
QH VX075F	75	23,47
QH VX090F	90	26,03
QH VX110F	110	46,74
QH VX125F	125	64,50
QH VX140F	140	74,53
QH VX160F	160	109,22

Junta plana para portabridas.
Junta en FKM (vitón).

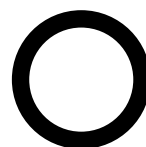

QPV-J

Ref.	Ø	€/EPDM
QH VX020E	20	0,82
QH VX025E	25	0,92
QH VX032E	32	1,39
QH VX040E	40	1,59
QH VX050E	50	1,91
QH VX063E	63	2,52
QH VX075E	75	3,90
QH VX090E	90	5,62
QH VX110E	110	7,14
QH VX125E	125	8,00
QH VX140E	140	3,56
QH VX160E	160	9,98
QH VX200E	200	11,70
QH VX225E	225	14,53
QH VX250E	250	40,79

Junta plana para portabridas.
Junta en EPDM.

Accesorios electrosoldables PE

Tomas simples

Tomas en carga

Válvulas PE para agua y gas

Accesorios electrosoldables

Frialen

INFRAESTRUCTURA





Aplicación

**MB - MANGUITOS CON TOPE, SDR 11**

Máxima presión de trabajo permitida 16 bar (agua) / 10 bar (gas)

Ref.	Ø	Ud./Caja	€/Ud.
612680	20	110	2,10
612681	25	90	3,93
616517	32	60	2,77
616520	40	40	2,82
616522	50	25	4,40
612685	63	15	8,95
612686	75	50	9,75
612687	90	30	10,91

Los manguitos MB SDR11 pueden ser soldados en tuberías SDR11 a SDR17,6

Espesor mínimo de tubo a soldar: 3.0 mm



Aplicación

**UB - MANGUITOS SIN TOPE, SDR 11**

Máxima presión de trabajo permitida 16 bar (agua) / 10 bar (gas)

Ref.	Ø	Ud./Caja	€/Ud.
612668	110	24	11,09
612669	125	16	13,45
615001	140	12	23,68
612671	160	8	21,45
612672	180	6	26,89
612673	200	1	26,95
612674	225	1	38,09
612675	250	1	92,87
615073	280	1	127,01
612670	315	1	161,17
615074	355	1	183,39
615075	400*	1	303,73
615076	450*	1	505,97
615124	500*	1	580,62
616312	560*	1	1.793,59
616269	630*	1	2.031,38
616313	710*	1	2.289,85
616314	800*	1	5.831,21

*** zonas de soldadura separada**

Los manguitos UB SDR11 pueden ser soldados en tuberías SDR11 a SDR17,6

Espesor mínimo de tubo a soldar: 3.0 mm



Aplicación

**FRIALONG - MANGUITOS LARGOS CON TOPES FÁCIL DE QUITAR**

PE 100 SDR11 Presión de servicio máxima admisible 16 bar (agua)/10 bar (gas)

Ref.	Ø	Ud./Caja	€/Ud.
615736	32	40	7,23
615737	40	30	9,40
615608	50	16	12,63
615738	63	10	13,48

Los manguitos FRIALONG pueden ser soldados en tuberías SDR11 a SDR17,6



Aplicación

**UB SDR9 - MANGUITOS SIN TOPE, SDR 9**

Máxima presión de trabajo permitida 20 bar (agua)

Ref.	Ø	Ud./Caja	€/Ud.
616441	400	1	574,06
616447	450	1	703,69
616445	500	1	993,10
616446	560	1	2.355,42
616439	630	1	3.265,13

Los manguitos UB SDR9 pueden ser soldados en tuberías SDR9 y SDR11

Consultar pedido mínimo en manguitos UB SDR 9 y SDR 7,4



Aplicación



UB - MANGUITOS SIN TOPE, SDR 17

Máxima presión de trabajo permitida 10 bar (agua) / 5 bar (gas)

Ref.	Ø	Ud./Caja	€/Ud.
616529	315	1	102,18
616530	355	1	139,23
616531	400*	1	217,60
616532	450*	1	271,24
616533	500*	1	410,47
615706	560*	1	461,80
615726	630*	1	747,54
615994	710*	1	902,83
616290	800*	1	1.522,98
616345	900*	1	1.927,08
616403	1000**	1	7.351,90
616416	1200**	1	13.084,58

* zonas de soldadura separada

** Para soldar se necesita una FRIAMAT XL

Los manguitos UB SDR17 pueden ser soldados en tuberías SDR17 y SDR26



Aplicación



UB PN25 - MANGUITOS SIN TOPE, SDR 7,4

Máxima presión de trabajo permitida 25 bar (agua)

Ref.	Ø	Ud./Caja	€/Ud.
616270	90	30	10,91
616271	110	24	17,64
616272	125	16	21,56
616273	140	12	82,95
616274	160	8	119,58
616282	180	6	102,90
616283	200	2	110,89
616284	225	1	123,37
616285	250	1	166,13
616287	315*	1	305,70
616288	355*	1	395,89

* zonas de soldadura separada

Los manguitos UB SDR7,4 pueden ser soldados en tuberías SDR7,4 a SDR11



Aplicación



AM - MANGUITOS SIN TOPE, SDR 17

Máxima presión de trabajo permitida 10 bar (agua)

Ref.	Ø	Ud./Caja	€/Ud.
680001	110	24	10,36
680013	125	22	13,10
680002	160	12	15,45
680003	180	8	25,37
680004	200	1	25,81
680005	225	4	36,15
680006	250	1	85,86
680007	280	1	92,55

* zonas de soldadura separada

Los manguitos AM SDR17 pueden ser soldados en tuberías SDR17 a SDR33



Aplicación



KM-XL - MANGUITOS CON ANILLO CÓNICO

PE 100 SDR17 Presión de servicio máxima admisible 10 bar (agua)/5 bar (gas)

Ref.	Ø	Ud./Caja	€/Ud.
616536	400	1	16.247,30
616537	450	1	16.877,96
616539	560	1	25.422,37
616523	630	1	25.753,39
616541	800	1	43.368,15
616434	1000	1	42.570,58
616435	1200	1	43.368,14

Los manguitos KM-XL pueden ser soldados en tuberías SDR17 a SDR17,6

Consultar pedido mínimo en manguitos UB SDR 9 y SDR 7,4



Aplicación



REM - MANGUITOS DE TRANSICIÓN RELINING

PE 100 SDR17 Presión de servicio máxima admisible 10 bar (agua)/5 bar (gas)

Ref.	Ø	Ud./Caja	€/Ud.
615569	110/100	24	109,22
615571	160/150	12	197,87
615576	315/300	1	781,60

Con código de barras de precalentamiento

Los manguitos REM pueden ser soldados en tuberías SDR17 a SDR17,6



Aplicación



MV - MANGUITOS DE CIERRE - TAPONES

PE 100 SDR11 - Máxima presión de trabajo permitida 16 bar (agua) / 10 bar (gas)

Ref.	Ø	Ud./Caja	€/Ud.
612025	20	40	4,35
612026	25	40	5,11
612027	32*	40	5,97
612028	40*	25	6,63
612029	50	20	9,03
612030	63	15	10,98
612031	75	20	16,89
612032	90	16	23,03
612033	110	12	28,81
612034	125	16	36,18
612035	160	10	49,99
616183	180	6	128,12
616184	200	4	169,38
616185	225	4	198,96

* También recomendado para sellar los extremos de accionamiento de las cuchillas de corte de las tomas en carga FRIALEN DAA/DAP ≤ d63.

Los tapones MV pueden ser soldados en tuberías SDR11 a SDR17,6

Espesor mínimo de tubo a soldar: 3.0 mm



Aplicación



MR - MANGUITOS DE REDUCCIÓN

Máxima presión de trabajo permitida 16 bar (agua) / 10 bar (gas)

Ref.	Ø	Ud./Caja	€/Ud.
616824	20-16	70	4,88
616452	32-16	70	5,67
615386	32-20	80	6,20
615502	32-25	70	5,81
615387	40-20	60	7,45
616751	40-25	120	6,20
615388	40-32	50	10,92
612069	50-20	32	11,67
616752	50-25	130	7,32
612070	50-32	32	7,79
612071	50-40	25	6,57
615389	63-32	18	8,01
615390	63-40	16	8,01
612072	63-50	16	8,01
616583	75-63	15	15,90
615391	90-50	15	18,20
615392	90-63	15	16,55
616582	90-75	15	19,16
615393	110-63	10	19,22
615693	110-90	8	19,46
615694	125-90	8	23,99
616510	125-110	16	44,58
615695	160-110	8	37,77
616511	180-125	1	67,05
616356	225-160	1	111,83

Las reducciones MR pueden ser soldadas en tuberías SDR11 a SDR17,6

Espesor mínimo de tubo a soldar: 3.0 mm



Aplicación



FRIASTOPP - MANGUITOS LARGOS CON MONITOR DEL FLUJO DE GAS INTEGRADO SISTEMA MERTIK MAXITROL

PE 100 SDR11 - Máxima presión de trabajo permitida 16 bar (agua) / 10 bar (gas)

Ref.	Tipo	Presión de servicio máxima rango Pmin-Pmáx.	VN	Ø	Ud/Caja	€/Ud
616187	Z	35 mbar- 5 bar	17 - 40	32	40	34,01
616188	Z	35 mbar- 5 bar	26 - 62	40	30	88,05
616189	Z	35 mbar- 5 bar	41 - 99	50	16	107,87
616190	Z	35 mbar- 5 bar	66 - 158	63	10	99,47
616191	D	25 mbar- 1 bar	11 - 16	32	40	48,22
616192	B	100 mbar- 5 bar	26 - 60	32	40	96,10
616193	D	25 mbar- 1 bar	19 - 27	40	30	119,96
616194	B	100 mbar- 5 bar	39 - 90	40	30	134,78
616195	D	25 mbar- 1 bar	28 - 40	50	16	64,27
616196	B	100 mbar- 5 bar	58 - 135	50	16	109,85
616197	D	25 mbar- 1 bar	51 - 72	63	10	127,57
616198	B	100 mbar- 5 bar	94 - 219	63	10	157,53

Manguito largo Frialong con SENTRY GS integrado. El monitor de flujo de gas corta el flujo de gas automáticamente en caso de daño del tubo p.e. por trabajos de excavadora o taladradora.

Con resistencia calefactora vista para una transmisión óptima del calor, con gran profundidad de inserción, con zonas de soldadura extra anchas así como zonas frías para evitar el flujo de material fundido en los extremos y en el centro.

Posibilita una ejecución sin dispositivos de sujeción-alineadores. El tipo Universal Z cubre de manera óptima los requisitos prácticos en el rango de presión de servicio y el caudal necesario. Los tipos D y Z disponen de válvula de exceso de flujo.

Marca de verificación DVGW del monitor de flujo de gas Sentry GS: DG-4360B00438.



Aplicación



FRIASTOPP - MANGUITOS LARGOS CON MONITOR DE FLUJO DE GAS INTEGRADO SISTEMA PIPELIFE- GAS STOP®

PE 100 SDR11 - Máxima presión de trabajo permitida 16 bar (agua) / 10 bar (gas)

Ref.	Tipo	Presión de servicio máxima rango Pmin-Pmáx.	VN	Ø	Ud/Caja	€/Ud
616199	U	35 mbar- 5 bar	15 - 35	32	40	42,78
616200	UUE	35 mbar- 5 bar	15 - 35	32	40	100,66
616201	U	35 mbar- 5 bar	35 - 80	50	20	123,54
616202	UUE	35 mbar- 5 bar	35 - 80	50	20	42,78
616203	U	35 mbar- 5 bar	55 - 120	63	12	100,66
616204	UUE	35 mbar- 5 bar	55 - 120	63	12	135,94
616205	A/D	25 mbar- 1 bar	10-14	32	40	53,33
616207	A/D	25 mbar- 1 bar	25 - 35	50	20	100,66
616209	A/D	25 mbar- 1 bar	40 - 55	63	12	135,94
616339	S	200 mbar- 5 bar	36 - 80	32	40	53,33
616340	S	200 mbar- 5 bar	110 - 240	50	20	100,66
616341	S	200 mbar- 5 bar	180 - 400	63	12	123,54

Manguito largo Frialong con parada de gas integrada. El monitor de flujo de gas corta el flujo de gas automáticamente en caso de daño del tubo p.e. por trabajos de excavadora o taladradora.

Con resistencia calefactora vista para una transmisión óptima del calor, con gran profundidad de inserción, con zonas de soldadura extra anchas así como zonas frías para evitar el flujo de material fundido en los extremos y en el centro.

Posibilita una ejecución sin dispositivos de sujeción-alineadores. El tipo Universal U cubre de manera óptima los requisitos prácticos en el rango de presión de servicio y el caudal necesario. Los tipos A/D, S y UUE y Z disponen de válvula de exceso de flujo.

Marca de verificación DVGW del monitor de flujo de gas Sentry GS: DG-4360BP0060.



Aplicación

**MR-STOPP - MANGUITO REDUCIDO CON MONITOR DE EXCESO DE FLUJO DE GAS INTEGRADO.
SISTEMA MERTIK MAXITROL**

PE 100 SDR11 Presión de servicio máxima admisible tipo Z: 5 bar (gas), tipo D: 1 bar (gas)

Ref.	Tipo	Presión de servicio máxima rango Pmin-Pmáx.	VN	Ø1-Ø2	Ud/Caja	€/Ud
616218	Z	35 mbar- 5 bar	26- 62	50- 40	12	163,45
616219	Z	35 mbar- 5 bar	17- 40	63- 32	18	142,59
616220	Z	35 mbar- 5 bar	26- 62	63- 40	16	165,72
616221	Z	35 mbar- 5 bar	41- 99	63- 50	16	236,75
616238	D	25 mbar- 1 bar	11- 16	63- 32	18	148,91
616240	D	25 mbar- 1 bar	28- 40	63- 50	16	182,70

Manguito reductor con SENTRY GS con parada de gas integrada. El monitor de flujo de gas corta el flujo de gas automáticamente en caso de daño del tubo p.e. por trabajos de excavadora o taladradora.

Con resistencia calefactora vista para una transmisión óptima del calor, con gran profundidad de inserción, con zonas de soldadura extra anchas así como zonas frías para evitar el flujo de material fundido en los extremos y en el centro.

Posibilita una ejecución sin dispositivos de sujeción-alineadores. El tipo Universal Z cubre de manera óptima los requisitos prácticos en el rango de presión de servicio y el caudal necesario. Los tipos D Y Z disponen de válvula de exceso de flujo.

Marca de verificación DVGW del monitor de flujo de gas Sentry GS: DG-4360B004380060

Consultar pedido mínimo para artículos reductores de flujo



Aplicación



WS11° - CODOS 11° M/H

PE 100 SDR11 Presión de servicio máxima admisible 16 bar (agua)/10 bar (gas)

Ref.	Ø	Ud./Caja	€/Ud.
616139	110	8	26,98
616140	125	5	36,81
616141	160	8	70,55
616142	180	4	91,39
616143	225	1	157,64

Los codos WS 11 ° pueden ser soldados en tuberías SDR11 a SDR17,6

Espesor mínimo de tubo a soldar: 3.0 mm



Aplicación



W30° - CODOS 30°

PE 100 SDR11 Presión de servicio máxima admisible 16 bar (agua)/10 bar (gas)

Ref.	Ø	Ud./Caja	€/Ud.
615272	90	8	23,61
615273	110	6	33,74
615274	125	4	45,71
615340	160	5	88,31
616261	180	3	111,95
616262	200	1	153,99
616263	225	1	188,94

Los codos W 30° pueden ser soldados en tuberías SDR11 a SDR17,6



Aplicación



W45° - CODOS 45°

PE 100 SDR11 Presión de servicio máxima admisible 16 bar (agua)/10 bar (gas)

Ref.	Ø	Ud./Caja	€/Ud.
616687	25	150	6,17
612092	32	45	6,60
612094	40	25	7,82
612096	50	20	9,87
612098	63	10	11,35
612100	75	14	15,87
612102	90	8	21,01
612104	110	10	30,93
612106	125	10	39,97
615275	160	4	78,82
615687	180	3	99,92
616264	200	1	146,84
615688	225	1	168,62

Los codos W 45 ° pueden ser soldados en tuberías SDR11 a SDR17,6



Aplicación



W45° XL - CODOS 45° XL

PE 100 SDR11 Presión de servicio máxima admisible 16 bar (agua)/10 bar (gas)

Ref.	Ø	Ud./Caja	€/Ud.
616404	250	1	680,38
616405	280	1	824,07
616406	315	1	1.089,29

Los codos W 45 ° XL pueden ser soldados en tuberías SDR11 a SDR17,6



Aplicación



W90° XL - CODO 90° XL

PE 100 SDR11 Presión de servicio máxima admisible 16 bar (agua)/10 bar (gas)

Ref.	Ø	Ud./Caja	€/Ud.
616408	250	1	684,44
616409	280	1	824,07
616410	315	1	1.089,29

Los codos W 90 ° XL pueden ser soldados en tuberías SDR11 a SDR17,6



Aplicación



W90° - CODOS 90°

PE 100 SDR11 Presión de servicio máxima admisible 16 bar (agua)/10 bar (gas)

Ref.	Ø	Ud./Caja	€/Ud.
616686	20	200	5,83
612091	25	60	6,17
612093	32	45	6,60
612095	40	25	7,82
612097	50	20	9,87
612099	63	8	11,35
612101	75	12	15,87
612103	90	6	21,01
612105	110	10	30,93
612107	125	8	39,97
615276	160	3	78,82
615689	180	3	99,92
616265	200	2	153,12
615690	225	1	168,62

Los codos W 90 ° pueden ser soldados en tuberías SDR11 a SDR17,6



Aplicación



WET - CODOS ESCALONADOS

PE 100 SDR11 Presión de servicio máxima admisible 16 bar (agua)/10 bar (gas)

Ref.	Ø	Ud./Caja	€/Ud.
616051	32	15	40,04
616052	40	15	45,08
616053	50	15	46,38
616054	63	10	60,99

Los codos WET pueden ser soldados en tuberías SDR11 a SDR17,6



Aplicación



TA - TÉS CON DERIVACIÓN EXTRA LARGA

PE 100 SDR11 Presión de servicio máxima admisible 16 bar (agua)/10 bar (gas)

Ref.	Ø	Ud./Caja	€/Ud.
616685	20	200	6,43
616338	25	40	7,29
615719	32	30	8,72
615720	40	20	9,37
615721	50	10	13,92
615722	63	10	14,18

Las tés TA red pueden ser soldadas en tuberías SDR11 a SDR17,6
Espesor mínimo de tubo a soldar: 3.0 mm



Aplicación



TA RED - TÉS REDUCIDAS

PE 100 SDR11 Presión de servicio máxima admisible 16 bar (agua)/10 bar (gas)

Ref.	Ø	Ud./Caja	€/Ud.
616417	32- 20	30	7,72
616418	40- 32	20	10,68
616419	50- 32	10	13,62
616420	50- 40	10	13,15
616421	63- 32	10	14,74
616422	63- 40	10	15,48
616423	63- 50	10	15,63

Las tés TA red pueden ser soldadas en tuberías SDR11 a SDR17,6



Aplicación



T - TÉS DE TRES BOCAS Y DOS SOLDADURAS

PE 100 SDR11 Presión de servicio máxima admisible 16 bar (agua)/10 bar (gas)

Ref.	Ø	Ud./Caja	€/Ud.
612165	75	8	23,27
612166	90	10	39,21
612167	110	6	38,91
612168	125	5	55,02
615277	160	3	92,23
615691	180	2	138,51
616266	200	1	180,39
615692	225	1	196,81

Las tés T pueden ser soldadas en tuberías SDR11 a SDR17,6



Aplicación



T XL - TÉS XL

PE 100 SDR11 Presión de servicio máxima admisible 16 bar (agua)/10 bar (gas)

Ref.	Ø	Ud./Caja	€/Ud.
616412	250*	1	914,52
616413	280*	1	1.140,09
616414	315*	1	1.517,08

*Pieza conformada por cuerpo inyectado y dos manguitos bifilares soldados en uno de sus extremos. Para alternativa de inyectado + 3 manguitos utilizar precios de Ref.s TEPE11000250, TEPE11000280 Y TEPE11000315 de la familia de Inyectados y las 612675,615073 y 612670 de Electrosoldables.

Las tés T XL pueden ser soldadas en tuberías SDR11 a SDR17,6



Aplicación



TE RED - XL - TÉS REDUCIDA XL

PE 100 SDR11 Presión de servicio máxima admisible 16 bar (agua)/10 bar (gas)

Ref.	Ø	Ud./Caja	€/Ud.
616426	250/110	1	885,34
616427	250/225	1	885,34
616428	280/110	1	1.086,29
616429	280/225	1	1.086,29
616430	315/110	1	1.359,28
616431	315/225	1	1.396,94

*Pieza conformada por cuerpo inyectado y dos manguitos bifilares soldados en uno de sus extremos. Para alternativa de manipulados + 2 manguitos utilizar precios de Ref.s de tés reducidas en capítulo Manipulados y para los manguitos las Ref.s en capítulo Electrosoldables.

Las tés T red XL pueden ser soldadas en tuberías SDR11 a SDR17,6



Aplicación



Y - PIEZAS EN Y DE PE 100 SDR11

PE 100 SDR11 Presión de servicio máxima admisible 16 bar (agua)/10 bar (gas)

Ref.	Ø	Ud./Caja	€/Ud.
640034	32-32-40	28	31,72
640036	40-40-50	18	34,46



Aplicación



YS - PIEZAS EN YS CON ESPIRALES CALEFACTORAS Y EXTREMO PE 100 SDR11

PE 100 SDR11 Presión de servicio máxima admisible 16 bar (agua)/10 bar (gas)

Ref.	Ø	Ud./Caja	€/Ud.
640035	32-32-40	28	31,72
640037	40-40-50	18	34,46

Las Y y las YS pueden ser soldadas en tuberías SDR11 a SDR17,6

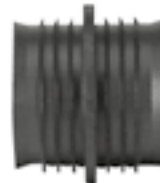

Aplicación



RW - BOQUILLAS DE REPARACIÓN

Ref.	Ø	Ud./Caja	€/Ud.
615127	32	50	5,81
615128	40	50	4,05
615129	50	50	8,05
615130	63	40	5,17

Sólo apto para tubo SDR 11



USTR - TRANSICIONES PE-AD/ACERO

PE 100 SDR11 Presión de servicio máxima admisible 10 bar (gas)

Ref.	Ø	Ud./Caja	€/Ud.
612780	32/25	15	34,82
612781	40/32	10	39,01
612782	50/40	8	48,32
612783	63/50	6	53,83
612789	75/65	4	136,17
612784	90/80	1	185,41
612785	110/100	1	197,02
612786	125/100	1	235,47
612787	160/150	1	378,73
615030	180/150	1	473,08
612795	200/200	1	535,51
612370	225/200	1	622,14

Otras dimensiones de rosca, o modelos, bajo consulta.
Las USTR pueden ser soldadas en tuberías SDR11 a SDR17,6



USTRS - TRANSICIONES PE-AD/ACERO (PARA SOLDAR CON MANGUITOS)

PE 100 SDR11 Presión de servicio máxima admisible 10 bar (gas)

Ref.	Ø	Ud./Caja	€/Ud.
616632	20/15	21	23,24
616633	25/20	21	25,82
616634	32/25	18	28,53
616635	40/32	12	32,62
616636	50/40	8	37,07
616637	63/50	6	48,95
616638	75/65	2	88,78
616639	90/80	2	90,53
616640	110/100	2	133,43
616641	125/100	2	139,53
616642	140/125	1	194,71
616643	160/150	1	320,65
616644	180/150	1	323,69
616645	200/200	1	471,56
616646	225/200	1	478,49
616647	250/250	1	882,60
616648	280/250	1	938,35
616649	315/300	1	1.381,31
616650	355/300	1	1.504,95
616651	400/400	1	3.107,71
616652	500/500	1	6.376,18
616653	630/600	1	10.773,55

Otras dimensiones de rosca, o modelos, bajo consulta.
Las USTRS pueden ser soldadas en tuberías SDR11 a SDR17,6



UFLG - TRANSICIONES PARA GAS LICUADO EN PE-AD/COBRE

PE 100 SDR11 Presión de servicio máxima admisible 5 bar (gas)

Ref.	Ø	Ud./Caja	€/Ud.
615733	32-20	25	66,55

Las UFLG pueden ser soldadas en tuberías SDR11 a SDR17,6



USTN - MANGUITOS DE TRANSICIÓN PE-AD/ACERO (ROSCA MACHO)

PE 100 SDR11 Presión de servicio máxima admisible 5 bar (gas)

Ref.	Ø	Ud./Caja	€/Ud.
612580	32-1"	20	26,78
612582	40-1 ¼"	20	34,99
612584	50-1 ½"	15	44,13
612586	63-2"	10	57,61

Otras dimensiones de rosca,, bajo consulta.
Las transiciones USTN pueden ser soldadas en tuberías SDR11 a SDR17,6
Espesor mínimo de tubo a soldar: 3.0 mm



USTM - MANGUITOS DE TRANSICIÓN PE-AD/ACERO (ROSCA HEMBRA)

PE 100 SDR11 Presión de servicio máxima admisible 5 bar (gas)

Ref.	Ø	Ud./Caja	€/Ud.
612570	32-1"	20	25,46
612572	40-1 ¼"	20	34,11
612574	50-1 ½"	15	41,66
612576	63-2"	10	56,26

Otras dimensiones de rosca,, bajo consulta.
Las transiciones USTM pueden ser soldadas en tuberías SDR11 a SDR17,6
Espesor mínimo de tubo a soldar: 3.0 mm



Aplicación



WUSTN 90° - CODOS DE TRANSICIÓN 90° UNIÓN PE-AD/ACERO (ROSCA MACHO)

PE 100 SDR11 Presión de servicio máxima admisible 5 bar (gas)

Ref.	Ø	Ud./Caja	€/Ud.
612602	40-1 ¼"	15	61,05
612604	50-1 ½"	10	48,61
612606	63-2"	10	63,51

Otras dimensiones de rosca, bajo consulta.

Las transiciones WUSTN pueden ser soldadas en tuberías SDR11 a SDR17,6

Espesor mínimo de tubo a soldar: 3.0 mm



Aplicación



WUSTM 90° - CODOS DE TRANSICIÓN 90° UNIÓN PE-AD/ACERO (ROSCA HEMBRA)

PE 100 SDR11 Presión de servicio máxima admisible 5 bar (gas)

Ref.	Ø	Ud./Caja	€/Ud.
612610	32-1"	20	26,45
612611	40-1"	15	49,50
612612	40-1 ¼"	15	59,56
612614	50-1 ½"	10	44,52
612616	63-2"	10	61,77

Otras dimensiones de rosca, o modelos, bajo consulta.

Las transiciones WUSTM pueden ser soldadas en tuberías SDR11 a SDR17,6

Espesor mínimo de tubo a soldar: 3.0 mm



Aplicación



MUN - MANGUITOS DE TRANSICIÓN UNIÓN PE-AD/LATÓN (ROSCA MACHO HEXAGONAL)

PE 100 SDR11 Presión de servicio máxima admisible 16 bar (agua)

Ref.	Ø	Ud./Caja	€/Ud.
612712	32-1"	20	20,55
612709	32-1 ¼"	20	29,71
612698	32-1 ½"	15	31,33
612721	40-1"	20	29,69
612713	40-1 ¼"	20	28,29
612718	40-1 ½"	20	34,14
612725	40-2"	20	58,81
612719	50-1"	15	39,83
612716	50-1 ¼"	15	38,75
612714	50-1 ½"	15	33,83
612706	50-2"	15	44,55
612722	63-1 ¼"	10	64,44
612717	63-1 ½"	10	55,60
612715	63-2"	10	50,25
612694	75-2"	10	111,34
612695	75-2 ½"	10	111,05

Estándar: latón. Otros materiales bajo consulta.

Otras dimensiones de rosca, bajo consulta.

Las transiciones MUN pueden ser soldadas en tuberías SDR11 a SDR17,6

Espesor mínimo de tubo a soldar: 3.0 mm



Aplicación



MUM - MANGUITOS DE TRANSICIÓN UNIÓN PE-AD/FUNDICIÓN (ROSCA HEMBRA HEXAGONAL)

PE 100 SDR11 Presión de servicio máxima admisible 16 bar (agua)

Ref.	Ø	Ud./Caja	€/Ud.
612595	32-1"	20	30,57
612596	40-1 ¼"	20	41,42
612692	50-1 ½"	15	50,12
612708	63-1 ½"	10	118,09
612693	63-2"	10	73,34

Estándar: latón. Otros materiales bajo consulta.

Otras dimensiones de rosca, bajo consulta.

Las transiciones MUM pueden ser soldadas en tuberías SDR11 a SDR17,6

Espesor mínimo de tubo a soldar: 3.0 mm



Aplicación



UAM ET - MANGUITOS DE TRANSICIÓN PE-AD / LATÓN CON TUERCA MÓVIL Y ROSCA HEMBRA

PE 100 SDR11 Presión de servicio máxima admisible 16 bar (agua)

Ref.	Ø	Ud./Caja	€/Ud.
616654	25-3/4"	100	36,33
616655	32-1"	60	47,11
616626	40-1 1/4"	35	54,24
616627	50-1 1/2"	30	61,53
616628	63-2"	20	78,05
616629	63-1 1/2"	20	76,60

Otras dimensiones de rosca, bajo solicitud.

Estándar: latón, acero bajo consulta

La junta de sellado no está incluida



Aplicación



WUN 90° - CODOS DE TRANSICIÓN PE-AD/ LATÓN (ROSCA MACHO HEXAGONAL)

PE 100 SDR11 Presión de servicio máxima admisible 16 bar (agua)

Ref.	Ø	Ud./Caja	€/Ud.
612120	32-1"	20	21,54
612140	32-1 1/2"	20	33,02
612127	40-1"	15	30,93
612122	40-1 1/4"	15	34,58
612121	40-1 1/2"	15	35,45
612119	50-1"	10	40,60
612123	50-1 1/4"	10	39,97
612124	50-1 1/2"	10	34,50
612125	63-1 1/2"	10	59,56
612126	63-2"	10	54,39

Estándar: latón. Otros materiales bajo consulta.

Otras dimensiones de rosca, bajo consulta.



Aplicación



UAN - TRANSICIONES ADAPTADOR MACHO PE-AD/LATÓN

PE 100 SDR11 Presión de servicio máxima admisible 16 bar (agua)/5 bar (gas)

Ref.	Ø	Ud./Caja	€/Ud.
616604	20-1/2"	100	10,29
616605	25-3/4"	100	12,83
616152	32-1"	60	18,48
616153	40 - 1 1/4"	35	26,88
616154	50-1 1/2"	30	31,00
616610	63-1 1/2"	20	38,78
616155	63-2"	20	40,53
616612	75-2 1/2"	14	73,47
616613	90-3"	6	94,98
616614	110-4"	4	142,47
616664	125-4"	4	157,87

Otras dimensiones de rosca,, bajo consulta.



Aplicación



UAM - TRANSICIONES ADAPTADOR HEMBRA PE-AD/LATÓN

PE 100 SDR11 Presión de servicio máxima admisible 16 bar (agua)/5 bar (gas)

Ref.	Ø	Ud./Caja	€/Ud.
616615	20-1/2"	150	8,01
616616	25-3/2"	100	13,06
616156	32-1"	60	15,27
616157	40-1 1/4"	50	22,46
616158	50-1 1/2"	35	26,15
616621	63-1 1/2"	20	32,62
616159	63 - 2"	20	35,45
616665	75-2 1/2"	14	60,91
616623	90-3"	10	79,54
616624	110-4"	6	126,45
616666	125-4"	6	130,69

Otras dimensiones de rosca,, bajo consulta.



Aplicación



EFL - PORTABRIDAS EMBRIDADAS

PE 100 SDR11 Presión de servicio máxima admisible 16 bar (agua)/5 bar (gas)

Ref.	Ø	Ud./Caja	€/Ud.
615417	63/50	5	68,25
615418	90/80	5	74,92
615419	110/100	3	83,51
615605	125/100	2	102,74
615421	160/150	2	144,26
615927	180/150	2	168,77
615607	225/200*	1	206,87

* Agujeros de brida para PN 10



Aplicación



FLR - REDUCCIONES EMBRIDADAS

PE 100 SDR11 Presión de servicio máxima admisible 16 bar (agua)

Ref.	Ø	Ud./Caja	€/Ud.
616065	110-80	3	212,09
616241	160-100	2	311,77



Aplicación



FLT - TÉS EMBRIDADAS

PE 100 SDR11 Presión de servicio máxima admisible 16 bar (agua)

Ref.	Ø	Ud./Caja	€/Ud.
615590	110-80	4	287,60
615591	125-80	3	310,60
615592	160-80	2	351,52
615910	180-80	1	671,78

PE 100 SDR17 Presión de servicio máxima admisible 10 bar (agua)

Ref.	Ø	Ud./Caja	€/Ud.
616031	225-80	2	1.227,88



Aplicación



VVS - CIERRES Y ABRAZADERAS DE REFUERZO

PE 100 SDR11 Presión de servicio máxima admisible 16 bar (agua)/10 bar (gas)

Ref.	Ø	Ud./Caja	€/Ud.
615164	90	24	56,10
615165	110	16	59,23
615166	125	15	79,28
615168	160	10	74,30
615169	180	6	123,01
615170	200	5	124,89
615171	225	5	123,35

Todas las abrazaderas (RS - VVS - VSC-TL y RS-XL) pueden ser soldadas en tuberías SDR11 a SDR17,6



Aplicación



RS - ABRAZADERAS DE REFUERZO

PE 100 SDR11 Presión de servicio máxima admisible 16 bar (agua)/10 bar (gas)

Ref.	Ø	Ud./Caja	€/Ud.
612519	63	20	30,65



Aplicación



VSC-TL - ABRAZADERAS DE REPARACIÓN TOP-LOADING

PE 100 SDR11 Presión de servicio máxima admisible 16 bar (agua)/10 bar (gas)

Ref.	Ø	Ud./Caja	€/Ud.
615397	250-560	10	34,64



Aplicación



SA - TOMAS SIMPLES

PE 100 SDR11 Presión de servicio máxima admisible 16 bar (agua)/10 bar (gas)

Ref.	Ø	Ud./Caja	€/Ud.
612757	63-32*	20	29,28
612759	63-50*	20	26,02
615020	75-50	15	32,21
615285	90-32	20	34,88
612819	90-63	20	32,12
615334	110-32	12	37,29
615031	110-50	12	33,74
612760	110-63	12	37,56
615411	110-90	12	57,28
615087	125-32	12	42,71
612761	125-63	12	39,90
615412	125-90	12	45,18
615584	125-110	10	49,06
612886	160-32	8	77,10
612762	160-63	6	76,54
615413	160-90	2	77,66
615739	160-110	2	78,00
615585	160-125	2	84,03
612763	180-63	6	47,13
615414	180-90	2	82,27
615948	180-110	2	83,89
615740	180-125	2	85,07
612764	200-63	5	44,37
612765	225-63	5	45,61
615415	225-90	5	82,02
616044	225-110	5	83,04
616045	225-125	4	89,70
616046	225-160	4	89,14



Aplicación



RS -XL - ABRAZADERAS DE REPARACIÓN

PE 100 SDR11 Presión de servicio máxima admisible 16 bar (agua)/10 bar (gas)

Ref.	Ø	Ud./Caja	€/Ud.
616366	500	1	3.891,96
616367	560	1	4.119,03
616368	630	1	4.255,89
616369	710	1	4.412,53
616370	800	1	4.697,81
616371	900	1	4.959,17
616372	1000	1	5.103,44
616379	1200	1	5.349,13



Aplicación



SAB - TOMAS SIMPLES CON TALADRO INTEGRADO

PE 100 SDR11 Presión de servicio máxima admisible 16 bar (agua)/10 bar (gas)

Ref.	Ø1-Ø2	Ud./Caja	€/Ud.
615091	63-32*	20	42,93
615092	90-32	20	72,79
615093	110-32	12	57,38
615094	125-32	12	79,62
615095	160-32	6	83,17

Las tomas simples SAB pueden ser soldadas en tuberías SDR11 a SDR17,6

*Excepto las Ø 63 que solo pueden serlo con SDR11

Las tomas simples SA pueden ser soldadas en tuberías SDR11 a SDR17,6

*Excepto las Ø 63 que solo pueden serlo con SDR11



Aplicación



SA-TL - TOMA SIMPLE SA-TL

PE 100 SDR11 Presión de servicio máxima admisible 16 bar (agua)/10 bar (gas)

Ref.	Ø1	Ø2	Ø3	Ud./Caja	€/Ud.
615465	250/560	32	21	5	82,46
615466	250/560	63	47	5	89,06

Las tomas simples SA-TL pueden ser soldadas en tuberías SDR11 a SDR17,6



Aplicación



SA-XL - TOMA SIMPLE SA-XL

PE 100 SDR11 Presión de servicio máxima admisible 16 bar (agua)/10 bar (gas)

Ref.	Ø1	Ø2	Ud./Caja	€/Ud.
616469	400	225	1	12.664,35
616779	400	250	1	6.525,50
616780	450	225	1	5.700,32
616781	450	250	1	5.345,10
616391	500	225	1	5.447,87
616782	500	250	1	5.678,49
616783	500	280	1	5.936,14
616784	500	315	1	6.101,05
616392	560	225	1	4.979,77
616785	560	250	1	4.979,77
616786	560	280	1	4.979,77
616787	560	315	1	4.979,77
616788	560	355	1	5.309,56
616789	560	400	1	6.430,83
616393	630	225	1	5.062,22
616790	630	250	1	5.062,22
616791	630	280	1	5.062,22
616792	630	315	1	5.062,22
616793	630	355	1	5.381,89
616794	630	400	1	6.562,74
616394	710	225	1	5.177,64
616795	710	250	1	5.177,64
616796	710	280	1	5.177,64
616797	710	315	1	5.177,64
616798	710	355	1	5.507,43
616762	710	400	1	6.595,72
616395	800	225	1	5.177,64
616799	800	250	1	5.260,10
616800	800	280	1	5.260,10
616801	800	315	1	5.260,10

Ref.	Ø1	Ø2	Ud./Caja	€/Ud.
616802	800	355	1	5.589,89
616803	800	400	1	6.925,51
616396	900	225	1	5.471,15
616804	900	250	1	5.359,04
616805	900	280	1	5.359,04
616806	900	315	1	5.359,04
616807	900	355	1	5.771,26
616808	900	400	1	7.585,08
616397	1000	225	1	5.177,64
616809	1000	250	1	5.507,43
616810	1000	280	1	5.507,43
616811	1000	315	1	5.919,66
616812	1000	355	1	6.249,45
616813	1000	400	1	7.914,87
616384	1200	225	1	5.771,26
616814	1200	250	1	5.771,26
616815	1200	280	1	5.771,26
616816	1200	315	1	6.166,99
616817	1200	355	1	6.595,72
616818	1200	400	1	8.574,43

PE 100 SDR17 Presión de servicio máxima admisible 10 bar (agua)/5 bar (gas)

Ref.	Ø1	Ø2	Ud./Caja	€/Ud.
616378	1000	160	1	4.880,83
616383	1200	160	1	5.210,62

*** Para otras dimensiones consultar SA UNI**

Las tomas simples SA-XL pueden ser soldadas en tuberías SDR11 a SDR17,6



Aplicación



SA-TL UNI - TOMAS SIMPLES SA-UNI

PE 100 SDR11 Presión de servicio máxima admisible 16 bar (agua)/10 bar (gas)

Ref.	Ø1	Ø2	Ud./Caja	€/Ud.
616553	250-280	90	5	119,32
616554	250-280	110	5	129,90
616555	250-280	125	5	138,68
616556	250-280	160	5	134,65
616557	315-400	90	5	128,55
616558	315-400	110	5	122,74
616559	315-400	125	5	145,88
616560	315-400	160	5	133,39
616561	450-800	90	5	149,86
616562	450-800	110	5	138,40
616563	450-800	125	5	159,18
616564	450-800	160	5	146,69

Las tomas simples SA-TL-UNI pueden ser soldadas en tuberías SDR11 a SDR17,6



Aplicación



SAFL - TOMAS SIMPLES CON SALIDA EMBRIDADA

PE 100 SDR11 Presión de servicio máxima admisible 16 bar (agua)/10 bar (gas)

Ref.	Ø1-Ø2	Ud./Caja	€/Ud.
616016	110-80	3	236,89
616017	125-80	2	230,09
616018	160-80	2	260,33
616019	180-80	2	269,47
616020	225-80	2	267,53
616022	160-100	2	291,93
616024	225-100	2	298,68

Las tomas simples SAFL pueden ser soldadas en tuberías SDR11 a SDR17,6



Aplicación



DAA-TL - TOMAS EN CARGA TOP-LOADING CON DERIVACIÓN EXTRA LARGA

PE 100 SDR11 Presión de servicio máxima admisible 16 bar (agua)/10 bar (gas)

Ref.	Ø1	Ø2	Ø3	Ud./Caja	€/Ud.
615527	080/130	50	50	20	147,91
615528	130/160	50	50	12	192,79
615531	160/210	63	50	5	174,79
615339	250/315(400)	63	50	5	259,57

Las tomas en carga DAA-TL pueden ser soldadas en tubos SDR11 a SDR17,6 desde Ø 250 a Ø 315
Para tubos mayores a Ø 315 sólo en SDR17



Aplicación



DAA - TOMAS EN CARGA CON DERIVACIÓN EXTRA LARGA

PE 100 SDR11 Presión de servicio máxima admisible 16 bar (agua)/10 bar (gas)

Ref.	Ø1	Ø2	Ø3	Ud./Caja	€/Ud.
612630	40	20	50	30	35,62
616473	40	25	50	30	35,62
616474	40	32	50	30	35,62
616475	50	20	50	28	46,11
612702	50	25	50	28	44,32
615080	50	32	50	28	44,32
612631	63	20	50	20	47,06
612633	63	25	50	20	47,06
612632	63	32	50	20	42,71
616334	63	63	50	20	51,08
616482	75	32	50	24	54,14
616483	90	20	50	14	59,62
616484	90	25	50	14	54,67
612634	90	32	50	14	54,67
612701	90	63	50	14	59,68
616487	110	20	50	14	53,76
616488	110	25	50	14	53,76
612637	110	32	50	14	53,76
612624	110	63	50	14	55,79
616491	125	20	50	12	71,77
616492	125	25	50	12	71,77
612649	125	32	50	12	71,77
612309	125	63	50	12	75,72
616495	140	32	50	12	90,49
616496	140	63	50	12	93,57
616497	160	20	50	10	63,55
616498	160	25	50	10	63,55
612641	160	32	50	10	63,55
612650	160	63	50	10	64,24
616501	180	20	50	10	71,43
616502	180	25	50	10	71,43
612651	180	32	50	10	71,43
612652	180	63	50	10	71,43
612654	200	32	50	8	79,28
612659	200	63	50	8	79,28
612657	225	32	50	8	103,23
612655	225	63	50	8	103,23

Las tomas en carga DAA pueden ser soldadas en tuberías SDR11 a SDR17,6

*Excepto las ≤ DN 63 que solo pueden serlo con SDR11

Las tomas en carga DAA pueden ser soldadas en tuberías SDR11 a SDR17,6

*Excepto las ≤ DN 63 que solo pueden serlo con SDR11



Aplicación



DAA (KIT) - TOMAS EN CARGA CON DERIVACIÓN EXTRA LARGA Y SUMINISTRADA CON UNA REDUCCIÓN MR

PE 100 SDR11 Presión de servicio máxima admisible 16 bar (agua)/10 bar (gas)

Ref.	Ø1	Ø2	Ø3	Ud./Caja	€/Ud.
616472	63	40	50	20	68,46
615656	90	40	50	14	75,03
616476	90	50	50	14	83,83
615662	110	40	50	14	79,91
615663	110	50	50	14	79,91
615668	125	40	50	12	92,66
616478	125	50	50	12	92,66
615675	160	40	50	10	91,98
616480	160	50	50	10	91,98
616481	180	50	50	10	101,04
616486	225	50	50	8	142,35

Las tomas en carga DAA (KIT) pueden ser soldadas en tuberías SDR11 a SDR17,6

*Excepto las DN 63 que solo pueden serlo con SDR11



Aplicación



DAP - TOMAS EN CARGA CON TALADRO Y DERIVACIÓN EXTRA LARGA EN PARALELO

PE 100 SDR11 Presión de servicio máxima admisible 16 bar (agua)/10 bar (gas)

Ref.	Ø1	Ø2	Ø3	Ud./Caja	€/Ud.
616042	63*	32	40	6	71,67
616043	90	32	50	16	79,54
615581	110	32	50	12	90,03
615606	110	50	50	12	96,14
615711	125	32	50	12	103,13
615712	125	50	50	12	111,01
615713	160	32	50	8	127,09
615714	160	50	50	8	128,49
615715	180	32	50	6	142,85
615716	180	50	50	6	142,85
615717	225	32	50	6	206,44
615718	225	50	50	6	206,44

Las tomas en carga DAP pueden ser soldadas en tuberías SDR11 a SDR17,6

*Excepto las DN 63 que solo pueden serlo con SDR11



Aplicación



K - TAPONES PARA DERIVACIONES DE TOMAS EN CARGA

PE 100 SDR11 Presión de servicio máxima admisible 16 bar (agua)/5 bar (gas)

Ref.	Ø	Ud./Caja	€/Ud.
612310	50	30	7,13

Los tapones K pueden ser soldados en tuberías SDR11 a SDR17,6
Espesor mínimo de tubo a soldar: 3.0 mm



Aplicación



VAM-RG-TL - TRANSICIONES TOMA SIMPLE TOP LOADING PE-AD/FUNDICIÓN ROSCA HEMBRA

PE 100 SDR11 Presión de servicio máxima admisible 16 bar (agua)/5 bar (gas)

Ref.	Ø	Ud./Caja	€/Ud.
615470	250/315-2"	10	132,12

Las transiciones VAM-RG-TL pueden ser soldadas en tuberías SDR11 a SDR17,6



Aplicación



SPA-TL - TOMAS TOP LOADING PARA OBTURACIÓN MEDIANTE BALÓN

PE 100 SDR11 Presión de servicio máxima admisible 16 bar (agua)/5 bar (gas)

Ref.	Ø	Ud./Caja	€/Ud.
615395	250-315 G 2 1/2"	18	86,69

Las tomas SPA-TL pueden ser soldadas en tuberías SDR11 a SDR17,6



Aplicación



SPAK - TAPONES PARA TOMA SPA PARA OBTURACIÓN MEDIANTE BALÓN

PE 100 SDR11 Presión de servicio máxima admisible 16 bar (agua)/5 bar (gas)

Ref.	Ø	Ud./Caja	€/Ud.
612311	75	20	16,59

Los tapones SPAK pueden ser soldados en tuberías SDR11 a SDR17,6



Aplicación



VAM-RG - TRANSICIONES TOMA SIMPLE PE-AD/FUNDICIÓN ROSCA HEMBRA

PE 100 SDR11 Presión de servicio máxima admisible 16 bar (agua)/10 bar (gas)

Ref.	Ø1-Ø2	Ud./Caja	€/Ud.
612794	63-1 1/4"	20	77,89
612743	63-1 1/2"	20	76,51
615213	75-1 1/4"	15	88,87
612798	90-1 1/2"	16	115,16
612778	90-2"	16	135,54
612732	110-1 1/2"	12	114,38
612733	110-2"	12	129,11
612734	125-1 1/2"	12	126,63
612735	125-2"	12	134,75
612728	160-1 1/2"	8	132,44
612729	160-2"	8	135,94
612774	180-1 1/2"	7	121,99
612776	180-2"	7	138,09
612827	225-2"	5	141,91

Las transiciones VAM-RG pueden ser soldadas en tuberías SDR11 a SDR17,6

*Excepto las DN 63 que solo pueden serlo con SDR11



Aplicación



SPA - TOMAS PARA OBTURACIÓN MEDIANTE BALÓN

PE 100 SDR11 Presión de servicio máxima admisible 16 bar (agua)/5 bar (gas)

Ref.	Ø	Ud./Caja	€/Ud.
612753	63	20	84,79
612677	90	16	87,56
612750	110	12	90,80
612751	125	12	94,28
612752	160	8	95,76
612754	180	7	96,60
612755	200	6	97,82
612756	225	5	97,35

Las tomas SPA pueden ser soldadas en tuberías SDR11 a SDR17,6

*Excepto las DN 63 que solo pueden serlo con SDR11



Aplicación



DAV - TOMAS EN CARGA CON VÁLVULA DE CORTE INCORPORADA CON DERIVACIÓN EXTRA LARGA

PE 100 SDR11 Presión de servicio máxima admisible 16 bar (agua)/10 bar (gas)

Ref.	Ø1	Ø2	Ud./Caja	€/Ud.
615955	50*	32	16	117,37
615341	63*	32	16	105,57
615342	63*	40	16	111,74
615956	75	32	12	123,38
615344	90	32	12	139,21
615346	90	50	12	141,02
615347	90	63	12	142,64
615348	110	32	10	131,06
615350	110	50	10	131,92
615351	110	63	10	134,48
615352	125	32	10	140,85
615354	125	50	10	141,15
615355	125	63	10	141,32
615930	140	63	6	144,75
615356	160	32	6	167,14
615358	160	50	6	166,31
615359	160	63	6	168,46
615361	180	32	5	168,65
615363	180	50	5	169,30
615364	180	63	5	169,48
615366	200	32	5	168,19
615368	200	50	5	197,11
615369	200	63	5	169,30
615374	225	32	5	167,34
615376	225	50	5	168,16
615377	225	63	5	168,16

Las tomas DAV pueden ser soldadas en tuberías SDR11 a SDR17,6

* Excepto las ≤ DN 63 que solo pueden serlo con SDR11



Aplicación



DAV-TL - TOMAS EN CARGA TOP LOADING CON VÁLVULA DE CORTE INCORPORADA CON DERIVACIÓN EXTRA LARGA

PE 100 SDR11 Presión de servicio máxima admisible 16 bar (agua)/10 bar (gas)

Ref.	Ø1	Ø2	Ud./Caja	€/Ud.
616464	250/315	50	10	212,01
616465	355/400	50	10	225,05

Las tomas DAV-TL pueden ser soldadas en tuberías SDR11 a SDR17,6



Aplicación



DAV (KIT) - TOMAS EN CARGA CON VÁLVULA DE CORTE INCORPORADA CON DERIVACIÓN EXTRA LARGA Y SUMINISTRADA CON UN MANGUITO MB O BIEN UNA REDUCCIÓN MR

PE 100 SDR11 Presión de servicio máxima admisible 16 bar (agua)/10 bar (gas)

Ref.	Ø1	Ø2	Ud./Caja	€/Ud.
615617	90	40	12	149,66
615621	110	40	10	140,58
615625	125	40	10	149,66
615629	160	40	6	177,23
615633	180	40	5	178,85
615641	225	40	5	179,37

Las tomas DAV (KIT) pueden ser soldadas en tuberías SDR11 a SDR17,6

* Excepto las ≤ DN 63 que solo pueden serlo con SDR11



Aplicación



EBS - SETS DE ACCIONAMIENTO PARA TOMA EN CARGA CON VÁLVULA DE CORTE INCORPORADA

Ref.	Longitud (mm)	Ud./Caja	€/Ud.
615866	0,45-0,70	1	70,51
615867	0,70-1,00	1	73,05
615335	0,90-1,30	1	73,47
615325	1,20-1,80	1	88,91
616327	1,80-2,70	1	360,78
616328	2,60-3,50	1	621,41



Aplicación



FBS - SETS DE ACCIONAMIENTO PARA VÁLVULA DE CORTE FRIALOC

Acero Galvanizado

Ref.	Ø	Longitud (mm)	Ud./Caja	€/Ud.
616308	90-250	0,75-1,00	1	114,50
616309	90-250	0,90-1,30	1	123,94
616310	90-250	1,20-1,80	1	130,69
616318	90-250	1,60-2,30	1	155,85

Acero Inoxidable

Ref.	Ø	Longitud (mm)	Ud./Caja	€/Ud.
616315	90-250	0,75-1,00	1	151,24
616316	90-250	0,90-1,30	1	166,21
616317	90-250	1,20-1,80	1	193,48
616319	90-250	1,60-2,30	1	250,64
616326	90-250	2,40-3,50	1	483,70



Aplicación



FRIALOC - VÁLVULAS DE CORTE FRIALOC CON CUERPO DE PE PARA SISTEMAS DE TUBERÍAS PLÁSTICAS

PE 100 SDR11 Presión de servicio máxima admisible 16 bar (agua)

Ref.	Ø	Ud./Caja	€/Ud.
616293	90	1	899,80
616294	110	1	898,28
616295	125	1	902,85
616296	160	1	1.523,42
616297	180	1	1.539,44
616453	200*	1	2.149,82
616298	225*	1	2.038,25
616438	250*	1	2.310,87

* El paso es limitado a Ø 180



Aplicación



KH - VÁLVULAS DE BOLA EN PE-AD, ¼ DE VUELTA. PASO TOTAL.

PE 100 SDR11 Presión de servicio máxima admisible 16 bar (agua)/10 bar (gas)

Ref.	Ø	Ud./Caja	€/Ud.
616174	20	1	57,75
616175	25	1	64,54
616176	32	1	71,33
616177	40	1	78,13
616178	50	1	145,36
616179	63	1	159,65
616180	90	1	220,80
616181	110	1	264,96
616182	125	1	475,55



Aplicación



KHP - VÁLVULAS DE BOLA EN PE-AD, ¼ DE VUELTA. PASO REDUCIDO.

PE 100 SDR11 Presión de servicio máxima admisible 16 bar (agua)/10 bar (gas)

Ref.	Ø	Ud./Caja	€/Ud.
612490	32	1	56,51
612497	40	1	63,58
612492	50	1	98,91
612494	63	1	127,16
612495	90	1	176,63
612493	110	1	211,95
612496	125	1	377,97
612483	160	1	621,76
615309	180	1	706,54
612480	200	1	816,03
616186	225	1	1.059,79



Aplicación



KHP-GAS - VÁLVULAS DE BOLA EN PE-AD, ¼ DE VUELTA PARA GAS. PASO REDUCIDO.

PE 100 SDR11 Presión de servicio máxima admisible 10 bar (gas)

Ref.	Ø	Ud./Caja	€/Ud.
612490GPL	32	1	64,54
612494GPL	63	1	142,67
612495GPL	90	1	207,77



Aplicación



KHPV-GAS - VÁLVULAS DE ESFERA EN PE-AD, ¼ DE VUELTA, CON VENTEOS, PARA GAS. PASO REDUCIDO.

PE 100 SDR11 Presión de servicio máxima admisible 10 bar (gas)

Ref.	Descripción	Ø - Venteos	Ud./Caja	€/Ud.
KHP0VE063GPL	Sin venteos	63-0VE	1	220,96
KHP1VE063GPL	Con un venteo	63-1VE	1	529,08
KHP2VE063GPL	Con dos venteos	63-2VE	1	795,74



Aplicación



AKHP - TOMAS SIMPLES CON VÁLVULA DE BOLA DE PE-AD, ¼ DE VUELTA, PARA MONTAJE EN RED EN CARGA. PASO REDUCIDO.

PE 100 SDR11 Presión de servicio máxima admisible 16 bar (agua)/10 bar (gas)

Ref.	Ø Tubo	Ø Válvula	Ud./Caja	€/Ud.
615427	110	63	6	308,38
615428	110	90	4	545,93
615431	125	90	4	549,95
615433	160	63	4	328,83
615434	160	90	4	554,47
615437	180	90	4	557,81
615440	225	90	4	560,57

Las tomas AKHP pueden ser soldadas en tuberías SDR11 a SDR17,6



Aplicación



AKHP-TL - TOMAS SIMPLES TOP LOADING CON VÁLVULA DE BOLA DE PE-AD, ¼ DE VUELTA PARA MONTAJE EN RED EN CARGA. PASO REDUCIDO.

PE 100 SDR11 Presión de servicio máxima admisible 16 bar (agua)/10 bar (gas)

Ref.	Ø Tubo	Ø Válvula	Ud./Caja	€/Ud.
615526	250/450	90	4	941,64

Las tomas AKHP-TL pueden ser soldadas en tuberías SDR11 a SDR17,6 en tubo de DN 250 hasta 450
Para tubos DN 500 y DN 560 sólo SDR17



Aplicación



BS - SETS DE ACCIONAMIENTO PARA KH,KHP, AKHP Y AKHP-TL

PE 100 SDR11 Presión de servicio máxima admisible 16 bar (agua)/10 bar (gas)

Ref.	Ø Tubo	Longitud (mm)	Ud./Caja	€/Ud.
615741	20-50	0,45 - 0,70	1	80,43
615957	20-50	0,60 - 1,00	1	87,09
615328	20-50	0,60 - 1,00	1	82,67
616466	20-50	1,00 - 1,50	1	93,04
615330	20-50	1,00 - 1,50	1	89,31
616068	20-50	1,20 - 2,00	1	92,97
615329	20-50	1,20 - 2,00	1	91,45
615958	63-225	0,60 - 1,00	1	98,15
615310	63-225	0,60 - 1,00	1	92,90
616467	63-225	1,00 - 1,50	1	102,14
615331	63-225	1,00 - 1,50	1	100,35
616069	63-225	1,20 - 2,00	1	111,05
615311	63-225	1,20 - 2,00	1	110,34

Máquinas de soldadura
Rascadores
Accesorios y herramientas

Equipos y herramientas Friatools

INFRAESTRUCTURA





FRIAMAT BASIC ECO
MÁQUINA UNIVERSAL DE SOLDADURA
SIN FUNCIÓN DE DOCUMENTACIÓN

Ref.	Descripción	€/Ud.
613120	Friamat basic eco con lápiz lector de código de barras	3.522,58
611120	Friamat basic eco con mini escáner lector de código de barras	3.714,72

Unidad de fusión universal para la unión de accesorios de DN 20 a DN 710. Compartimento de almacenamiento para accesorios, opción de lector código de barras o escáner para el reconocimiento de códigos de barras. Teclado de fácil manejo. Selección de idiomas, volumen de timbre ajustable, e introducción manual de notas.

Cable de conexión (4 m) y cable de red (5 m) extra largos. Peso aproximado 18 kg.

Suministrado en una práctica caja de aluminio de protección para el transporte.



FRIAMAT PRIME ECO
MÁQUINA UNIVERSAL DE
SOLDADURA CON FUNCIÓN DE
DOCUMENTACIÓN Y TRAZABILIDAD

Ref.	Descripción	€/Ud.
613124	Friamat prime eco con lápiz lector de código de barras	5.764,23
611124	Friamat prime eco con mini escáner lector de código de barras	5.956,37

Unidad de fusión para la soldadura mediante accesorios de electrofusión de tubos de cualquier tamaño (hasta DN 900). Fácil guía de usuario con un gran display, maxi-guía y modernos interfaces: Puertos USB (A + B) para la transmisión de datos a través de tarjeta de memoria FRIATEC (incluida); para la conexión de impresoras, volcado de datos y de documentos PDF.

Puerto paralelo para conexión a impresora y PC.

Contraseña de supervisor para el ajuste individual de las funciones del dispositivo.

Possibilidad de introducir coordenadas GPS, e introducir información a través de textos de código de barras, con lápiz lector o escáner de código de barras (opcional).

Selección de idiomas, volumen de timbre ajustable, e introducción manual de notas. Cable de conexión (4 m) y cable de red (5 m) extra largos.

Peso aproximado 18 kg.

Suministrado en una práctica caja de aluminio de protección para el transporte.



FRIAMAT PRIME
MÁQUINA UNIVERSAL DE SOLDADURA
CON FUNCIÓN DE DOCUMENTACIÓN Y
TRAZABILIDAD



Ref.	Descripción	€/Ud.
613103	Friamat prime con lápiz lector de código de barras	7.205,30
611103	Friamat prime con mini escáner lector de código de barras	7.397,43

Unidad de fusión para la soldadura mediante accesorios de electrofusión de tubos de cualquier tamaño (hasta DN 900).

Display gráfico de gran tamaño para un fácil manejo. Conexión USB para la transmisión de datos. FRIATEC Memory-Stick (incluido). Salida de datos en el formato de base de vía datos FRIATRACE, como ficheros PDF o CSV.

Certificado de supervisor para el ajuste personalizado de las funciones (p. ej. bloqueo de funciones, fijación de operaciones forzadas, etc.)

Con lápiz óptico o lector de código de barras, bolsillo para guardar los adaptadores, introducción de coordenadas GPS, introducción de texto informativo mediante código de barras, selección del idioma, ajuste el volumen del zumbador, introducción manual de emergencia. Cable de conexión (4 m) y cable de red (5 m) extra largos. Peso aproximado 12,8 kg. Suministrado en una práctica caja de aluminio de protección para el transporte.



FRIAMAT BASIC
MÁQUINA UNIVERSAL DE SOLDADURA
SIN FUNCIÓN DE DOCUMENTACIÓN

Ref.	Descripción	€/Ud.
613104	Friamat basic con lápiz lector de código de barras	5.043,71
611104	Friamat basic con mini escáner lector de código de barras	5.235,85

Unidad de fusión para la soldadura mediante accesorios de electrofusión de tubos de cualquier tamaño (hasta DN 900). Con lápiz óptico o lector de código de barras, fácil manejo, bolsillo para guardar los adaptadores, teclado sinóptico, selección del idioma, ajuste el volumen del zumbador, introducción manual de emergencia. Cable de conexión (4 m) y cable de red (5 m) extra largos. Peso aproximado 12,8 kg. Suministrado en una práctica caja de aluminio de protección para el transporte.



FRIAMAT PRINT ECO
MÁQUINA UNIVERSAL DE SOLDADURA
CON FUNCIÓN DE DOCUMENTACIÓN

Ref.	Descripción	€/Ud.
613122	Friamat print eco con lápiz lector de código de barras	4.460,84
611122	Friamat print eco con mini escáner lector de código de barras	4.814,12

Unidad de fusión universal para la unión de accesorios de DN20 a DN1200. Puerto USB para la transmisión de datos para la conexión a impresora de datos y de documentación PDF. Selección de idiomas, volumen de timbre ajustable e introducción manual de notas. Cable de conexión (4 m) y cable de red (5 m) extra largos. Peso aproximado 18 kg. Suministrada en una práctica caja de aluminio de protección para el transporte



FRIAMAT XL
MÁQUINA UNIVERSAL DE SOLDADURA
PARA GRAN DIÁMETRO CON FUNCIÓN DE
DOCUMENTACIÓN Y TRAZABILIDAD

Ref.	Descripción	€/Ud.
613091	Con escáner lector de código de barras	14.458,62

La máquina más potente del mercado FRIAMAT XL. Suelda hasta DN 1200. Máquina de soldadura para la unión de la línea de productos FRIALEN XL, FRIALEN Y FRIAFIT. Fácil guía de usuario con un gran display, maxi-guía y modernos interfaces: Puertos USB (A + B) para la transmisión de datos a través de tarjeta de memoria FRIATEC (incluida); para la conexión de impresoras, volcado de datos y de documentos PDF. Puerto paralelo para conexión a impresora y PC. Contraseña de supervisor para el ajuste individual de las funciones del dispositivo. Posibilidad de introducir coordenadas GPS, e introducir información a través de textos de código de barras, con lápiz lector o escáner de código de barras (opcional). Selección de idiomas, volumen de timbre ajustable, e introducción manual de notas. Cable de conexión (4 m) y cable de red con conector CEE de 400 V (4 m) extralargos. Peso aproximado 50 kg. Suministrado en una práctica caja de aluminio de protección para el transporte.



MEMSTICK - MEMORIA PORTATIL USB

Ref.	Descripción	€/Ud.
624023	Memoria USB	34,87

Memoria portátil USB para almacenar los datos de soldadura y transferirlos de los equipos FRIAMAT (sólo los que tengan función de documentación) al software FRIATRACE así como la transmisión de un PDF al PC.



FWLESST - LÁPIZ LECTOR DE CÓDIGO DE BARRAS

Ref.	Descripción	€/Ud.
623645	Lápiz lector	272,20

Lápiz lector de códigos de barras FRIAMAT apto para leer los códigos de soldadura y de trazabilidad.

Apto para todos los equipos de soldadura FRIAMAT.



NUEVO ESCÁNER LECTOR DE CÓDIGOS DE BARRAS

Ref.	Descripción	€/Ud.
624005	Mini escáner	464,35



PA-USB - FRIAMAT ADAPTADOR USB PARALELO

Ref.	Descripción	€/Ud.
613263	Adaptador USB paralelo	415,03

Para la conexión de una impresora con puerto USB tipo B a los máquinas de soldadura FRIAMAT desde el año de construcción 2000 con puerto paralelo. Permite la impresión directa de los datos de soldadura mediante impresora USB (no sirve con impresoras GDI).

Alimentación eléctrica a través de la fuente de alimentación incluida.

Adaptadores incluidos.



FRIATRACE - SOFTWARE- BANCO DE DATOS

Ref.	Descripción	€/Ud.
613280	FRIATRACE Software para base de datos	450,58
624026	FRIATRACE Combi Package	524,55

Software para el tratamiento posterior de los datos de soldadura de las máquinas FRIAMAT (solo con función de documentación) en el PC, incluyendo el tratamiento posterior de los datos de trazabilidad. Adecuado para los sistemas operativos Windows NT 4.0/2000 y Windows XP. Con función de base de datos (todos los datos de soldadura en una base de datos), para explotación, copia, selección, búsqueda, formateo, edición, etc. Consta de:

- CD-ROM
- Cable de conexión PC – máquina
- Descripción del programa

Paquete combinado (FRIATRACE Combi Package) para los equipos de soldadura FRIAMAT con la trazabilidad y la función de la documentación.

Consta de:

- Memory Stick
- CD-ROM (software FRIATRACE)
- Descripción del Programa



SPASS - TARJETA DE SOLDADOR

Ref.	Descripción	€/Ud.
623100	Tarjeta de soldador	48,79

Para identificación del soldador y protección ante la manipulación de terceros de las máquinas FRIAMAT. El número de obra y nombre de soldador se registran en la memoria de la máquina.

Para pedidos, por favor, solicitar formulario.



SUPER-P - TARJETA DE SUPERVISOR

Ref.	Descripción	€/Ud.
623101	Tarjeta de supervisor	48,79

Tarjeta para el control del menú de funciones de la FRIAMAT XL y FRIAMAT Prime.

Para pedidos, por favor, solicitar formulario.



CONTACT 4 - BORNES DE CONEXIÓN DE 4,0 MM

Ref.	Descripción	€/Ud.
624529	Bornes de 4,0 mm	58,17

Para la conexión al accesorio de soldadura en toda nuestra gama FRIAMAT.

Estos conectores se venden por unidad.



ADBK - ADAPTADORES PARA BORNES DE 4,7 MM

Ref.	Descripción	€/Par
613237	Adaptadores de bornes	116,31

Adaptador para bornes de 4,7 mm para cualquier tipo de FRIAMAT.

Estos conectores se venden por pares.



ADFL - ADAPTADORES BIFILARES

Ref.	Descripción	€/Par.
613236	Adaptadores Bifilares	97,87

Para conectar a los bornes de cualquier tipo de FRIAMAT.

Estos conectores se venden por pares.



ALTK (FMT) - CAJA DE ALUMINIO PARA TRANSPORTE

Ref.	Descripción	€/Ud.
627600	Caja de transporte para nuevas FRIAMAT prime / basic	422,70
627001	Caja de transporte para antiguas FRIAMAT prime / basic	422,70
627001	Caja de transporte para FRIAMAT prime eco / basic eco	422,70
613302	Caja de transporte para FRIAMAT XL	507,25

Para el transporte y el almacenamiento de equipos de soldadura FRIAMAT. Otras cajas de transporte para equipos más antiguos FRIAMAT (I-II) bajo consulta.



FWSG RA - RASCADOR COMPACTO PARA EXTREMOS DE TUBOS E INJERTOS CON SALIDA DN 25 HASTA DN 63

Ref.	Ø	SDR	Descripción	€/Ud.
613580	DN 32	SDR 11	FWSG RA DN 32	400,94
613581	DN 40	SDR 11	FWSG RA DN 40	413,74
613582	DN 50	SDR 11	FWSG RA DN 50	440,12
613583	DN 63	SDR 11	FWSG RA DN 63	469,34
613579	Todos los DN		FWSG RA MANIVELA	64,81

Rascador compacto específico de cada diámetro utilizado para la eliminación segura del recubrimiento de óxido en tubos de PE-AD y PE-XA y en salidas de DAA, DAV, DAP, SA, TA etc...

Con cuchilla extra larga, también apto para manguitos largos FRIALONG.

Colocación rápida y fácil a través de un mecanismo novedoso. Compensación automática de irregularidades y tolerancias de los tubos.

Accionamiento manual por manivela o con máquina taladradora y llave Allen.



FWSG 63 - RASCADOR PARA TUBOS DESDE DN 20 HASTA DN 63

Ref.	Descripción	€/Ud.
613408	Rascador para tubos DN 20 a DN 63	1.421,84

Para eliminar de forma segura la capa de óxido de las tuberías de HDPE y PE-XA.

Cuchilla extra ancha de metal duro.

Incluye 1 cuchilla de repuesto.

Suministrado en una práctica caja de aluminio de protección para el transporte.



FWSG 225 - RASCADOR PARA TUBOS DESDE DN 75 HASTA DN 225

Ref.	Descripción	€/Ud.
613311	Rascador para tubos DN 75 a DN 225	2.218,59

Para eliminar de forma segura la capa de óxido de las tuberías de HDPE y PE-XA.

Cuchilla extra ancha de metal duro.

Incluye 1 cuchilla de repuesto.

Suministrado en una práctica caja de aluminio de protección para el transporte.



FWSG 710 L - RASCADOR PARA TUBOS DESDE DN 250 HASTA DN 710

Ref.	Descripción	€/Ud.
613642	Rascador para tubos DN 250 a DN 710	3.612,25

Para eliminar de forma segura la capa de óxido de las tuberías de HDPE y PE-Xa a la mitad o completo. Rascador de gran longitud. Cuchilla con hoja de carburo para una larga duración y raspado uniforme. Suministrado en una práctica caja de aluminio de protección para el transporte



FWSG 710 S - RASCADOR PARA TUBOS DESDE DN 250 HASTA DN 710 Y ACCESORIOS A TOPE

Ref.	Descripción	€/Ud.
613639	Rascador para tubos DN 250 a DN 710 y accesorios a tope	3.612,25

Para eliminar de forma segura la capa de óxido de las tuberías de HDPE y PE-Xa a la mitad o completo y para el raspado seguro de piezas y tubos que van a ser soldados a testa.

Rascador de gran longitud. Cuchilla con hoja de carburo para una larga duración y raspado uniforme. Suministrado en una práctica caja de aluminio de protección para el transporte.



WSG 900 L - RASCADOR PARA TUBOS DESDE DN 630 HASTA DN 900

Ref.	Descripción	€/Ud.
613644	Rascador para tubos desde DN 630 a DN 900	8.121,16

Para eliminar de forma segura la capa de óxido de las tuberías de HDPE y PE-Xa a la mitad o completo y para el raspado seguro de piezas y tubos que van a ser soldados a testa.

Rascador de gran longitud. Cuchilla con hoja de carburo para una larga duración y raspado uniforme. Suministrado en una práctica caja de aluminio de protección para el transporte.



FWSG XL - RASCADOR PARA TUBOS DESDE DN 800 HASTA DN 1200

Ref.	Descripción	€/Ud.
613645	Rascador para tubos DN 800 a DN 1200	19.982,67

Para eliminar de forma segura la capa de óxido en las tuberías de PE-AD en diámetros desde 800 a 1200, SDR11 - SDR33. Diseño modular para un fácil manejo y rápida instalación. Ajuste rápido y seguro al ancho del tubo. Montaje central, accionamiento mediante manivela. Compensación automática de la ovalidad de tubería y tolerancias mediante una cuchilla alojada en muelle móvil.

Cuchilla reversible para doblar la duración.

Suministrado en una práctica caja de aluminio de protección para el transporte.



FWSG 63 - RASCADOR PARA TUBOS DESDE DN 20 HASTA DN 63

Ref.	Ø	Descripción	€/Ud.
613562	DN 63	FWSG SE 63	1.242,52
613563	DN 75	FWSG SE 75	1.314,24
613564	DN 90	FWSG SE 90	1.314,24
613565	DN 110	FWSG SE 110	1.314,24
613566	DN 125	FWSG SE 125	1.473,08
613567	DN 140	FWSG SE 140	1.546,16
613568	DN 160	FWSG SE 160	1.473,08
613569	DN 180	FWSG SE 180	1.670,35
613570	DN 200	FWSG SE 200	1.670,35
613571	DN 225	FWSG SE 225	1.670,35
613572	DN 250	FWSG SE 250	1.841,99
613573	DN 280	FWSG SE 280	1.841,99
613574	DN 315	FWSG SE 315	1.935,84

Rascador para extremos de tubos y tomas simples y en carga. Dimensionado para cada diámetro para un raspado seguro y libre de óxido. Se usa en tuberías PE-AD y PE-XA.

Cuchillas reversibles para doblar la duración. Fácil fijación gracias al diseño de apertura y cierre.

Suministrado en una práctica caja de aluminio de protección para el transporte.



PFSP - SPRAY DE ACEITE PARA EL MANTENIMIENTO DE LOS RASCADORES DE FRIATEC

Ref.	Descripción	€/Ud.
613301	Spray de mantenimiento FRIATEC	28,70

Para la limpieza y el mantenimiento de rascadores. Contenido 100 ml. Observe con atención las instrucciones de seguridad y utilización indicadas en el recipiente del spray de mantenimiento, y a las pertinentes instrucciones de uso de las rascadores.



FWSG RA - CUCHILLAS DE REPUESTO PARA RASCADORES

Ref.	Descripción	€/Ud.
613322 (1)	FWSGE 3. Cuchillas para FWSG 225/315 Y FWSGA. Pintadas de color rojo	286,42
613323 (1)	FWSGE 4. Cuchillas para FWSG 63. Pintadas de color verde	286,42
613324 (1)	FWSGE 5. Cuchillas para FWSG 710 L/S / FWSG 900 L. Pintadas de color azul	286,42
613325 (2)	FWSGE 6. Cuchillas para FWSGS 110 / FWSGS 180	286,42
613326 (2)	FWSGE 7. Cuchillas para FWSGS 225	286,42

(1) Integrado por 3 unidades de cuchillas de repuesto, 1 tornillo de cabeza de estrella y 1 llave cabeza estrella.

(2) Integrado por 1 unidad de cuchillas de repuesto, 2 tornillos de cabeza de estrella y 1 llave cabeza estrella.

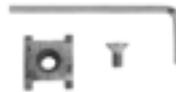

Ref.	Descripción	€/Ud.
613327 (3)	FWSGE 8. Cuchillas para FWSG SE (todos los DN)	198,81

(3) Integrado por 1 unidad de cuchillas de repuesto, 1 tornillo de cabeza de estrella y 1 llave cabeza estrella.



Ref.	Descripción	€/Ud.
613329 (4)	FWSGE 10. Cuchillas para FWSG RA 32 y 40	135,27
613330 (4)	FWSGE 11. Cuchillas para FWSG RA 50 y 63	135,27

(4) Integrado por 1 unidad de cuchillas de repuesto, 1 tornillo de cabeza de estrella y 1 llave cabeza estrella.



Ref.	Descripción	€/Ud.
613331 (5)	FWSGE 12. Cuchillas para FWSG XL	549,01

(5) Integrado por 1 unidad de cuchillas de repuesto, 1 placa de deslizamiento. 2 tornillos de cabeza de estrella y 1 llave cabeza de estrella.

Cuchillas de repuesto de metal duro (alta estabilidad, larga duración)



ALTK (FWSG) - CAJA DE ALUMINIO PARA EL TRANSPORTE DE LOS RASCADORES FRIATEC

Ref.	Descripción	€/Ud.
613307	ALTK FWSG 63	69,40
613309	ALTK FWSG 225 Y 63/225	167,39
613308	ALTK FWSG 710 S	316,32
613314	ALTK FWSG 710 L	316,32
613304	ALTK FWSG 900 L	337,08
613303	ALTK FWSG SE 63	160,02
613319	ALTK FWSG SE 75-140	178,91
613318	ALTK FWSG SE 160	184,45
613320	ALTK FWSG SE 250-315	270,69

Para transportar y almacenar rascadores.



FWZ - RASCADOR MANUAL

Ref.	Descripción	€/Ud.
613300	Rascador manual	32,54
613270	Cuchillas de repuesto 5 uds.	24,60

Para la eliminación de la capa de óxido de las tuberías de PE – AD y accesorios, así como para desbarbar el canto cortado.

Cuchillas de repuesto en pack de 5 uds.

FWZ - RASCADOR MANUAL

Ref.	Descripción	€/Ud.
613299	Rascador manual gran Ø	214,43

Para eliminar la capa de óxido de tubos de PE de gran diámetro, que no pueden ser rascados con rascadores convencionales.

Sirve especialmente para la preparación de las superficies de unión con tomas simples del tipo FRIALEN XL. También es apto para quitar las rebabas de bordes cortados.

Dispone de dos superficies de corte.



FRIATOP - DISPOSITIVO DE FIJACIÓN (TOP LOADING)

Ref.	Descripción	€/Ud.
613350	Dispositivo Top Loading	2.625,92

Dispositivo de fijación, presión y colocación para el montaje de las tomas simples y en carga FRIALEN Top Loading. No requiere fijación inferior. Accionamiento con muelle neumático extra elástico para una óptima presión durante el proceso de fusión.

**VACUPUMP - BOMBA DE VACÍO PARA UTILIZACIÓN EN OBRA PARA SA-XL Y RS-XL**

Ref.	Descripción	€/Ud.
613827	Bomba de vacío 230 V	3.000,61

Para la instalación de derivaciones Frialen XL SA-XL y abrazaderas de reparación RS-XL. Se compone de bomba de vacío (110 V/230 V) manómetro y mangueras de conexión. No requiere compresor adicional para su funcionamiento. Se suministra en un maletín de aluminio.

**PRESSKO - ÉMBOLO PARA LAS TOMAS EN CARGA FRIALEN XL Y SA-XL**

Ref.	Dimensión émbolo	Descripción	€/Ud.
613821	DN 160	Émbolo para FRIALEN SA-XL	450,90
613822	DN 225	Émbolo para FRIALEN SA-XL	568,74
613823	DN 250	Émbolo para FRIALEN SA-XL	654,49
613853	DN 280	Émbolo para FRIALEN SA-XL	864,64
613854	DN 315	Émbolo para FRIALEN SA-XL	950,71
613855	DN 355	Émbolo para FRIALEN SA-XL	1.007,49
613837	DN 400	Émbolo para FRIALEN SA-XL	2.337,71

Émbolo de fijación y conexión del Vacuset XL con salida DN 160 a DN 400

**FWAB XL - BROCA DE PERFORACIÓN FWAB XL PARA SA-XL**

Ref.	Descripción	DN de la salida	€/Ud.
613832	FWAB XL 90	DN 90	1.933,42
613833	FWAB XL 110	DN 110	2.000,67
613834	FWAB XL 125	DN 125	2.058,32
613829	FWAB XL 160 SDR11	DN 160	2.197,62
613838	FWAB XL 160 SDR17	DN 160	2.449,81
613830	FWAB XL 225	DN 225	2.461,82
613831	FWAB XL 250	DN 250	2.733,21
613850	FWAB XL 280	DN 280	3.304,82
613851	FWAB XL 315	DN 315	3.506,58
613852	FWAB XL 355	DN 355	3.506,58
613836	FWAB XL 400	DN 400	3.522,58

FWAB XL para la perforación de tubos de PE-AD. Con sistema de despresurización a través de la salida de los accesorios SA-XL. Consistente en una sierra cortante del DN elegido, un adaptador SDS max, extensión para el adaptador, broca central y cavidad para alojamiento de la viruta. Se debe utilizar un taladro eléctrico. Se entrega en un maletín de aluminio.

**UNITOP - DISPOSITIVO DE FIJACIÓN PARA LAS TOMAS SIMPLES SA-UNI**

Ref.	Descripción	€/Ud.
613385	Dispositivo de fijación para tomas simples Frialen SA-UNI	4.803,53
613241	Adaptadores en ángulo para conexiones por socket 4.0 mm	64,38

Dispositivo de fijación para las tomas de derivación simple SA-UNI DN 250 a DN 710 con salidas DN 90, DN 110, DN 125 y DN 160. Se suministra en un maletín de aluminio.

**FWXR - CONJUNTO REDONDEADOR PARA TUBOS DESDE DN 32 A DN 250**

Ref.	Descripción	DN base	Medias lunas de reducción	€/Ud.
613416	FWXR-S1	DN 63	para DN 32, 40 y 50	615,30
613431	FWXR-S2	DN 110	para DN 90	555,10
613439	FWXR-S3	DN 160	para DN 125	825,41
613443	FWXR-S4	DN 200	para DN 180	3.334,48
613444	FWXR-S5	DN 250	para DN 225	3.632,53

Para redondear tubos de PE-AD y PE-X.

Abarca diferentes medidas mediante la colocación de medias lunas de reducción.

**FWXRH - REDONDEADOR HIDRÁULICO PARA TUBERÍA DESDE DN 280 HASTA DN 900**

Ref.	Descripción	€/Ud.
613452	Redondeador hidráulico para tubo DN 280	10.191,16
613461	Redondeador hidráulico para tubo DN 315	10.457,60
613462	Redondeador hidráulico para tubo DN 355	10.457,60
613463	Redondeador hidráulico para tubo DN 400	12.051,08
613464	Redondeador hidráulico para tubo DN 450	12.473,81
613465	Redondeador hidráulico para tubo DN 500	13.934,07
613467	Redondeador hidráulico para tubo DN 560	15.448,15
613466	Redondeador hidráulico para tubo DN 630	15.791,44
613468	Redondeador hidráulico para tubo DN 710	17.218,23
613460	Redondeador hidráulico para tubo DN 800	20.402,97
613458	Redondeador hidráulico para tubo DN 900	16.821,95

Para redondear tubos de PE-AD y los tubos de PE-XA. Para esta técnica de redondeo, también ofrecemos alquiler de equipos.

FWXRB - REDONDEADOR MECÁNICO PARA TUBERÍA DESDE DN 800 HASTA DN 1200

Ref.	Descripción	€/Ud.
613457	Redondeador mecánico para tubos DN 800 a DN 1200	9.105,89

Para redondear tubos de PE-AD con un diámetro entre DN 800 y DN 1200. Para esta técnica de redondeo, también ofrecemos alquiler de equipos.

CLAMP 63 - ALINEADOR PARA TUBOS DESDE DN 20 HASTA DN 63

Ref.	Descripción	€/Ud.
613020	Alineador para tubos DN 20 a DN63	487,50
613034	Alineador para tubos DN 32 a DN63 para instalación con FRIALONG	771,38

Alineador universal con ajuste de ángulo (45° y 90°), para manguitos, reducciones y salidas en accesorios de toma de derivación electrosoldable desde DN 20 a DN 63.

Opcional: versión CLAMP63L para instalaciones de manguitos extra largos FRIALONG.

CLAMP 180 - ALINEADOR PARA TUBOS DESDE DN 63 HASTA DN 180

Ref.	Descripción	€/Ud.
613021	Alineador con dos elementos fijadores	1.198,10
613022	Elemento fijador adicional	239,01
613023	Set de medias lunas reductoras DN 110-DN 160	83,86
613024	Extensión en forma de Té	943,12

Alineador con ajuste de ángulo (45° y 90°), y dos elementos fijadores para manguitos, reducciones y codos de DN 63, DN 90, DN 125 y DN180.

Se pueden acoplar medias lunas reductoras para crear diferentes configuraciones. Se suministra en una práctica bolsa.

El alineador se puede expandir con elementos fijadores adicionales para uso cuádruple de DN 63, DN 90, DN 125 y DN 160. Se necesitarían dos alineadores adicionales.

Disponibles elemento de extensión en Té para fijación y alineación. Variante con un solo alineador. Elementos fijadores adicionales pueden acoplarse para fijación doble en acometidas.

Medias lunas de reducción para DN 110 y DN 160. Se necesita un juego de media luna para cada elemento fijador.



SQM 63 Y 125 - PINZADOR PARA TUBOS DESDE DN 20 HASTA DN 125

Ref.	Descripción	DN	SDR	€/Ud.
613025	Pinzador SQM 63	DN 20 a DN 63	SDR 11	227,24
613026	Pinzador SQM125	DN 63 a DN 90	SDR 11	539,13
613026	Pinzador SQM125	DN 90 a DN 125	SDR 17,6	539,13

Pinzador para corte temporal en tubos de PE-AD y PE-Xa en DN 63 a DN 125 en SDR 11 y SDR 17,6.
 Cumple con la DVGW GW 332.



SQH 180 - PINZADOR HIDRÁULICO PARA TUBOS DESDE DN 63 HASTA DN 180

Ref.	Descripción	DN	SDR	€/Ud.
613028	Pinzador SQH180	DN 63 a DN 180	SDR 11 Y SDR 17,6	1.409,10

Pinzador para corte temporal en tubos de PE-AD y PE-Xa en DN 63 a DN 125 en SDR 11 y SDR 17,6.
 Cumple con la DVGW GW 332.



RRC90



RRC110

RRC - REDONDEADOR DE TUBOS PINZADOS DN 63 A DN 180

Ref.	Descripción	DN	€/Ud.
613029	Redondeador RRC90	DN 63, DN 75 y DN 90	1.305,60
613030	Redondeador RRC110	DN 110	415,56
613031	Redondeador RRC125	DN 125	369,90
613032	Redondeador RRC160	DN 160	437,54
613033	Redondeador RRC180	DN 180	411,66

Para redondear tubo pinzados de PE-AD y PE-XA de DN 63 a DN 180. El RRC90 es un redondeador universal para DN63, DN 75 y DN 90. Se pueden acoplar medias lunas reductoras para crear diferentes configuraciones. Incluye llave para activar el redondeador universal.

El RRC110 a RRC180 se utiliza específicamente en cada diámetro DN 100, DN 125, DN 160 y DN 180.



KIT DE REPARACIÓN

Ref.	Descripción	DN	€/Ud.
613701	Kit de reparación universal	Todos los diámetros	914,59
613715	Set prolongador	Todos los diámetros	868,65
613702	TIPO 1	DN 90 a DN 180	76,86
613703	TIPO 2	DN 200 a DN 315	118,17
613704	TIPO 3	DN 355 a DN 450	317,67
613705	TIPO 4	DN 500 a DN 560	420,15
613706	TIPO 5	DN 630	491,05
613707	TIPO 6	DN 710	580,34
613708	TIPO 7	DN 800	790,41
613709	TIPO 8	DN 900	934,83
613700	ALTK RPS-CAJA DE TRANSPORTE		249,79

Kit de reparación para la retención del agua residual durante los trabajos de reparación e integración en tuberías de PE-AD con diámetro entre DN 90 y DN 900. Está compuesto de kit de reparación universal con bomba, manómetro, taladro y tubo flexible de conexión, así como globos de reparación.

A partir del diámetro 355 se necesita para comenzar a taladrar el dispositivo de cierre para taladrar FWAB XL 225 Ref. 613830.

Para poder utilizar el kit de reparación hasta diámetro 225, se necesitan abrazaderas de cierre y refuerzo VVS. A partir de diámetro 250, se necesitan abrazaderas de cierre VSC-TL o abrazaderas de reparación RS-XL.



FWPM - MARCADOR PLATEADO

Ref.	Descripción	€/Ud.
613069	Marcador indeleble color plata	62,77

Para el marcado de tubos PE – AD y PE-X color plata.
Contenido de cada paquete: 10 unidades



FWSR - LLAVE PARA ACCIONAMIENTO DE LA TOMA EN CARGA CON TALADRO Y DERIVACIÓN EXTRA LARGA EN PARALELO DAP

Ref.	DN	SW	€/Ud.
613610	Llave 1/2"		67,15
613605	Conector allen	19	19,57
613606	Conector allen	17	32,02

Para el accionamiento del taladro de la toma en carga de salida en paralelo.
Incluye llave de carraca y conector Allen.



FWSS - LLAVE PARA ACCIONAMIENTO DE LA TOMA EN CARGA - FRIALEN

Ref.	DN	SW	€/Ud.
613246	DN 40 a DN 225	17	37,44
613250	DN 90 a DN 315	19	18,99

Para el accionamiento del taladro de la toma en carga según la dimensión DN1 de las tomas DAA, DAA-TL (mirar lista de precios de accesorio de seguridad FRIALEN).

SW17 es también apropiado para el accionamiento del taladro para todas las SAB.



PRODUCTOS LIMPIADORES DE ÓXIDO ESPECÍFICOS PARA POLIETILENO

Ref.	Descripción	€/Ud.
614001	Bote limpiador 0,75 Litros	27,54
614002	Toallitas limpiadoras	32,07

Producto específico para una óptima limpieza y desoxidación del PE.
Alta volatilidad, 99,9% alcohol.



FWDPA - ADAPTADOR DE MANÓMETRO

Ref.	Descripción	€/Ud.
613595	FWDPA para Frialen DAA,DAA-TL,DAA-TL RE Y DAP	73,46
613596	FWDPA para Frialen SA-UNI	184,01

Para la conexión a un manómetro en la prueba de presión de armaduras FRIALEN DAA, DAP, DAA-TL, DA-TL/RE d1 = 63-315. Medida de conexión a rosca hembra R 1/4".



PCUT

Ref.	Descripción	€/Ud.
613040	Cortatubos para PE DN 20 a DN 63 SDR11	222,05
613041	Cortatubos para PE DN 50 a DN 140 SDR11	427,00
613042	Recambio cuchilla cortatubos DN 20 a DN 63	13,29
613043	Recambio cuchilla cortatubos DN 50 a DN 140	97,06



PCUT S

Ref.	Descripción	€/Ud.
613044	Cortatubos para PE DN 20 a DN 40 SDR11	115,88
613046	Cortatubos para PE DN 20 a DN 63 SDR11	168,24

Accesorios de PE

Accesorios de Polietileno inyectados largos

INFRAESTRUCTURA



**RDPE - REDUCCIÓN**

Con cuello largo para soldar con accesorios de alta seguridad FRIALEN, o soldadura a tope.



Aplicación



PE 100 SDR11 - Máxima presión de trabajo permitida 16 bar (agua) / 10 bar (gas)

Ref.	Ø	€/Ud.
RDPE11003225	32-25	3,30
RDPE11004020	40-20	4,85
RDPE11004025	40-25	4,85
RDPE11004032	40-32	4,85
RDPE11005025	50-25	5,17
RDPE11005032	50-32	5,66
RDPE11005040	50-40	5,66
RDPE11006332	63-32	7,80
RDPE11006340	63-40	7,80
RDPE11006350	63-50	7,80
RDPE11007540	75-40	11,96
RDPE11007550	75-50	21,36
RDPE11007563	75-63	21,36
RDPE11009050	90-50	15,42
RDPE11009063	90-63	15,42
RDPE11009075	90-75	15,42
RDPE11011063	110-63	18,54
RDPE11011075	110-75	18,54
RDPE11011090	110-90	16,68
RDPE11012563	125-63	26,31
RDPE11012575	125-75	26,31
RDPE11012590	125-90	26,31
RDPE11125110	125-110	26,31
RDPE11014075	140-75	36,00
RDPE11014090	140-90	36,00
RDPE11140110	140-110	36,00
RDPE11140125	140-125	36,00
RDPE11016090	160-90	50,64
RDPE11160110	160-110	50,64
RDPE11160125	160-125	50,64
RDPE11160140	160-140	50,64

Ref.	Ø	€/Ud.
RDPE11180125	180-125	56,64
RDPE11180160	180-160	61,58
RDPE11200125	200-125	62,24
RDPE11200160	200-160	59,85
RDPE11225110	225-110	115,01
RDPE11225160	225-160	115,01
RDPE11225180	225-180	115,01
RDPE11250160	250-160	156,30
RDPE11250180	250-180	163,54
RDPE11250200	250-200	163,54
RDPE11250225	250-225	163,54
RDPE11280180	280-180	203,27
RDPE11280200	280-200	203,27
RDPE11280225	280-225	203,27
RDPE11280250	280-250	195,73
RDPE11315225	315-225	280,34
RDPE11315250	315-250	280,34
RDPE11315280	315-280	280,34
RDPE11355250	355-250	589,56
RDPE11355280	355-280	589,56
RDPE11355315	355-315	589,56
RDPE11400280	400-280	624,68
RDPE11400315	400-315	624,68
RDPE11400355	400-355	624,68
RDPE11450400	450-400	672,43
RDPE11500355	500-355	805,06
RDPE11500400	500-400	838,68
RDPE11500450	500-450	905,94
RDPE11630400	630-400	1.276,28
RDPE11630450	630-450	1.304,88
RDPE11630500	630-500	1.416,72



Aplicación



PE 100 SDR17 - Máxima presión de trabajo permitida 10 bar (agua) / 5 bar (gas)

Ref.	Ø	€/Ud.
RDPE17007540	75-40	11,96
RDPE17007563	75-63	15,23
RDPE17009050	90-50	16,47
RDPE17009063	90-63	16,47
RDPE17009075	90-75	16,47
RDPE17011063	110-63	14,45
RDPE17011075	110-75	14,45
RDPE17011090	110-90	12,28
RDPE17012563	125-63	26,31
RDPE17012575	125-75	26,31
RDPE17012590	125-90	26,31
RDPE17125110	125-110	26,31
RDPE17014075	140-75	37,80
RDPE17014090	140-90	37,80
RDPE17140110	140-110	37,80
RDPE17140125	140-125	37,80
RDPE17016090	160-90	50,64
RDPE17160110	160-110	50,64
RDPE17160125	160-125	50,64
RDPE17160140	160-140	50,64
RDPE17180125	180-125	56,64
RDPE17180160	180-160	61,58
RDPE17200125	200-125	53,02
RDPE17200160	200-160	48,41
RDPE17225110	225-110	115,01
RDPE17225160	225-160	115,01
RDPE17225180	225-180	115,01

Ref.	Ø	€/Ud.
RDPE17250160	250-160	163,54
RDPE17250180	250-180	163,54
RDPE17250200	250-200	163,54
RDPE17250225	250-225	163,54
RDPE17280180	280-180	203,27
RDPE17280200	280-200	203,27
RDPE17280225	280-225	203,27
RDPE17280250	280-250	195,73
RDPE17315225	315-225	280,34
RDPE17315250	315-250	280,34
RDPE17315280	315-280	280,34
RDPE17355250	355-250	624,68
RDPE17355280	355-280	624,68
RDPE17355315	355-315	367,66
RDPE17400280	400-280	660,05
RDPE17400315	400-315	660,05
RDPE17400355	400-355	571,62
RDPE17450315	450-315	695,54
RDPE17450355	450-355	723,78
RDPE17450400	450-400	763,72
RDPE17500355	500-355	899,61
RDPE17500400	500-400	950,10
RDPE17500450	500-450	1.000,54
RDPE17630400	630-400	1.229,05
RDPE17630450	630-450	1.284,12
RDPE17630500	630-500	1.407,11



Aplicación



WWPE - CODO 30°

Con cuello largo para soldar con accesorios de alta seguridad FRIALEN, o soldadura a tope.

PE 100 SDR11 - Máxima presión de trabajo permitida 16 bar (agua) / 10 bar (gas)

Ref.	Ø	€/Ud.
WWPE1100075	75	24,76
WWPE1100090	90	36,05
WWPE1100110	110	53,45
WWPE1100125	125	87,74
WWPE1100140	140	96,10
WWPE1100160	160	122,83
WWPE1100180	180	175,99
WWPE1100200	200	220,99
WWPE1100225	225	274,84

PE 100 SDR17 - Máxima presión de trabajo permitida 10 bar (agua) / 5 bar (gas)

Ref.	Ø	€/Ud.
WWPE1700075	75	24,08
WWPE1700090	90	30,29
WWPE1700110	110	39,47
WWPE1700125	125	61,74
WWPE1700140	140	79,92
WWPE1700160	160	90,07
WWPE1700180	180	127,26
WWPE1700200	200	140,45
WWPE1700225	225	179,59

Para otras medidas, diámetros y tipo de accesorios, consultar.



Aplicación



HDPE - CODO 45°

Con cuello largo para soldar con accesorios de alta seguridad FRIALEN, o soldadura a tope.

PE 100 SDR11 - Máxima presión de trabajo permitida 16 bar (agua) / 10 bar (gas)

Ref.	Ø	€/Ud.
HDPE11000025	25	4,85
HDPE11000032	32	5,80
HDPE11000040	40	7,27
HDPE11000050	50	8,26
HDPE11000063	63	14,74
HDPE11000075	75	19,90
HDPE11000090	90	16,08
HDPE11000110	110	22,91
HDPE11000125	125	52,43
HDPE11000140	140	58,56
HDPE11000160	160	56,20
HDPE11000180	180	87,09
HDPE11000200	200	101,64
HDPE11000225	225	141,40
HDPE11000250	250	245,16
HDPE11000280	280	369,89
HDPE11000315	315	449,02
HDPE11000355	355	1.025,20
HDPE11000400	400	1.366,75
HDPE11000450	450	1.864,19
HDPE11000500	500	2.091,50



Aplicación



GDPE - CODO 90°

Con cuello largo para soldar con accesorios de alta seguridad FRIALEN, o soldadura a tope.

PE 100 SDR11 - Máxima presión de trabajo permitida 16 bar (agua) / 10 bar (gas)

Ref.	Ø	€/Ud.
GDPE11000025	25	4,43
GDPE11000032	32	4,83
GDPE11000040	40	6,12
GDPE11000050	50	8,12
GDPE11000063	63	14,74
GDPE11000075	75	19,43
GDPE11000090	90	14,35
GDPE11000110	110	22,51
GDPE11000125	125	52,43
GDPE11000140	140	58,56
GDPE11000160	160	61,78
GDPE11000180	180	86,35
GDPE11000200	200	109,90
GDPE11000225	225	150,44
GDPE11000250	250	234,25
GDPE11000280	280	394,55
GDPE11000315	315	496,90
GDPE11000355	355	1.003,91
GDPE11000400	400	1.382,73
GDPE11000450	450	1.809,05
GDPE11000500	500	2.207,08

PE 100 SDR17 - Máxima presión de trabajo permitida 10 bar (agua) / 5 bar (gas)

Ref.	Ø	€/Ud.
HDPE17000063	63	6,09
HDPE17000075	75	17,98
HDPE17000090	90	15,29
HDPE17000110	110	21,69
HDPE17000125	125	47,29
HDPE17000140	140	58,00
HDPE17000160	160	43,14
HDPE17000180	180	77,72
HDPE17000200	200	81,83
HDPE17000225	225	127,18
HDPE17000250	250	210,90
HDPE17000280	280	318,28
HDPE17000315	315	396,06
HDPE17000355	355	738,54
HDPE17000400	400	1.108,72
HDPE17000450	450	1.305,50
HDPE17000500	500	1.654,07

PE 100 SDR17 - Máxima presión de trabajo permitida 10 bar (agua) / 5 bar (gas)

Ref.	Ø	€/Ud.
GDPE17000063	63	6,45
GDPE17000075	75	17,61
GDPE17000090	90	14,42
GDPE17000110	110	24,27
GDPE17000125	125	47,29
GDPE17000140	140	58,00
GDPE17000160	160	51,98
GDPE17000180	180	77,72
GDPE17000200	200	99,77
GDPE17000225	225	127,18
GDPE17000250	250	209,66
GDPE17000280	280	316,40
GDPE17000315	315	396,15
GDPE17000355	355	819,70
GDPE17000400	400	999,00
GDPE17000450	450	1.270,91
GDPE17000500	500	1.772,04

Para otras medidas, diámetros y tipo de accesorios, consultar.



Aplicación



Aplicación



YEPE - Y 45°

Con cuello largo para soldar con accesorios de alta seguridad FRIALEN, o soldadura a tope.

PE 100 SDR11 - Máxima presión de trabajo permitida 16 bar (agua) / 10 bar (gas)

Ref.	Ø	€/Ud.
YEPE11000040	40	9,93
YEPE11000050	50	17,19
YEPE11000063	63	32,03
YEPE11000075	75	42,84
YEPE11000090	90	76,54
YEPE11000110	110	102,88
YEPE11000125	125	202,51
YEPE11000160	160	327,21
YEPE11000180	180	434,12
YEPE11000200	200	536,70
YEPE11000225	225	737,26
YEPE17000315	315	711,55

PE 100 SDR17 - Máxima presión de trabajo permitida 10 bar (agua) / 5 bar (gas)

Ref.	Ø	€/Ud.
YEPE17000040	40	5,19
YEPE17000050	50	16,35
YEPE17000063	63	27,52
YEPE17000075	75	39,41
YEPE17000090	90	82,73
YEPE17000110	110	74,02
YEPE17000125	125	185,22
YEPE17000160	160	309,61
YEPE17000180	180	407,19
YEPE17000200	200	481,87
YEPE17000225	225	694,52
YEPE17000315	315	711,55

TEPE - TE IGUAL 90°

Con cuello largo para soldar con accesorios de alta seguridad FRIALEN, o soldadura a tope.

PE 100 SDR11 - Máxima presión de trabajo permitida 16 bar (agua) / 10 bar (gas)

Ref.	Ø	€/Ud.
TEPE11000025	25	5,38
TEPE11000032	32	6,42
TEPE11000040	40	7,73
TEPE11000050	50	10,25
TEPE11000063	63	14,06
TEPE11000075	75	21,27
TEPE11000090	90	19,95
TEPE11000110	110	30,95
TEPE11000125	125	65,61
TEPE11000140	140	99,19
TEPE11000160	160	78,71
TEPE11000180	180	162,77
TEPE11000200	200	149,71
TEPE11000225	225	277,59
TEPE11000250	250	394,08
TEPE11000280	280	506,77
TEPE11000315	315	756,99
TEPE11000355	355	1.229,79
TEPE11000400	400	1.294,03
TEPE11000450	450	1.682,75
TEPE11000500	500	2.298,83

PE 100 SDR17 - Máxima presión de trabajo permitida 10 bar (agua) / 5 bar (gas)

Ref.	Ø	€/Ud.
TEPE17000063	63	10,81
TEPE17000075	75	18,40
TEPE17000090	90	22,31
TEPE17000110	110	29,61
TEPE17000125	125	55,74
TEPE17000140	140	84,77
TEPE17000160	160	71,44
TEPE17000180	180	138,49
TEPE17000200	200	127,80
TEPE17000225	225	235,66
TEPE17000250	250	236,65
TEPE17000280	280	323,90
TEPE17000315	315	450,57
TEPE17000355	355	1.149,30
TEPE17000400	400	1.026,83
TEPE17000450	450	1.200,44
TEPE17000500	500	2.449,53

Para otras medidas, diámetros y tipo de accesorios, consultar.



Aplicación



TRPE - TE REDUCIDA 90°

Con cuello largo para soldar con accesorios de alta seguridad FRIALEN, o soldadura a tope.

PE 100 SDR11 - Máxima presión de trabajo permitida 16 bar (agua) / 10 bar (gas)

Ref.	Ø	€/Ud.
TRPE11006332	63-32	28,75
TRPE11011063	110-63	50,24
TRPE11011090	110-90	32,71
TRPE11012563	125-63	75,83
TRPE11012575	125-75	75,83
TRPE11012590	125-90	75,83
TRPE11125110	125-110	75,83
TRPE11014063	140-63	114,54
TRPE11014075	140-75	114,54
TRPE11014090	140-90	114,54
TRPE11140110	140-110	118,66
TRPE11016063	160-63	137,30
TRPE11016075	160-75	138,35
TRPE11016090	160-90	138,35
TRPE11160110	160-110	141,93
TRPE11018075	180-75	196,66
TRPE11018090	180-90	196,66
TRPE11180110	180-110	196,66
TRPE11180125	180-125	196,66

Ref.	Ø	€/Ud.
TRPE11180140	180-140	190,95
TRPE11180160	180-160	190,95
TRPE11020063	200-63	249,49
TRPE11020075	200-75	249,49
TRPE11020090	200-90	249,49
TRPE11200110	200-110	176,64
TRPE11200125	200-125	249,49
TRPE11200160	200-160	249,49
TRPE11022563	225-63	308,29
TRPE11022575	225-75	308,29
TRPE11022590	225-90	320,37
TRPE11225110	225-110	322,75
TRPE11225125	225-125	323,64
TRPE11225140	225-140	323,81
TRPE11225160	225-160	323,81
TRPE11250160	250-160	425,62
TRPE11280160	280-160	363,87
TRPE11315160	315-160	495,04

PE 100 SDR17 - Máxima presión de trabajo permitida 10 bar (agua) / 5 bar (gas)

Ref.	Ø	€/Ud.
TRPE17011063	110-63	45,07
TRPE17011090	110-90	34,62
TRPE17012563	125-63	59,42
TRPE17012575	125-75	59,42
TRPE17012590	125-90	59,42
TRPE17125110	125-110	59,42
TRPE17014063	140-63	98,10
TRPE17014075	140-75	98,10
TRPE17014090	140-90	98,10
TRPE17140110	140-110	101,95
TRPE17016063	160-63	123,54
TRPE17016075	160-75	127,35
TRPE17016090	160-90	127,35
TRPE17160110	160-110	128,47
TRPE17018075	180-75	196,66
TRPE17018090	180-90	196,66
TRPE17180110	180-110	196,66

Ref.	Ø	€/Ud.
TRPE17180125	180-125	196,66
TRPE17180140	180-140	171,70
TRPE17180160	180-160	171,70
TRPE17020063	200-63	220,05
TRPE17020075	200-75	220,05
TRPE17020090	200-90	220,05
TRPE17200110	200-110	141,07
TRPE17200125	200-125	220,05
TRPE17200160	200-160	220,05
TRPE17022563	225-63	288,69
TRPE17022575	225-75	288,69
TRPE17022590	225-90	288,69
TRPE17225110	225-110	290,76
TRPE17225125	225-125	290,76
TRPE17225140	225-140	290,76
TRPE17225160	225-160	290,76

Para otras medidas, diámetros y tipo de accesorios, consultar.



Aplicación



CDPE - TAPÓN

Con cuello largo para soldar con accesorios de alta seguridad FRIALEN, o soldadura a tope.

PE 100 SDR11 - Máxima presión de trabajo permitida 16 bar (agua) / 10 bar (gas)

Ref.	Ø	€/Ud.
CDPE11000025	25	4,00
CDPE11000032	32	4,64
CDPE11000040	40	6,19
CDPE11000050	50	7,92
CDPE11000063	63	10,49
CDPE11000075	75	19,40
CDPE11000090	90	10,91
CDPE11000110	110	17,03
CDPE11000125	125	34,48
CDPE11000140	140	43,46
CDPE11000160	160	34,01
CDPE11000180	180	62,53
CDPE11000200	200	62,26
CDPE11000225	225	93,00
CDPE11000250	250	107,18
CDPE11000280	280	150,99
CDPE11000315	315	206,73
CDPE11000355	355	408,30
CDPE11000400	400	515,74
CDPE11000450	450	403,89
CDPE11000500	500	532,33
CDPE11000630	630	1.162,98

PE 100 SDR17 - Máxima presión de trabajo permitida 10 bar (agua) / 5 bar (gas)

Ref.	Ø	€/Ud.
CDPE17000063	63	2,49
CDPE17000075	75	19,56
CDPE17000090	90	10,09
CDPE17000110	110	13,29
CDPE17000125	125	34,43
CDPE17000140	140	43,14
CDPE17000160	160	28,20
CDPE17000180	180	62,53
CDPE17000200	200	56,73
CDPE17000225	225	93,00
CDPE17000250	250	55,22
CDPE17000280	280	150,99
CDPE17000315	315	206,73
CDPE17000355	355	324,21
CDPE17000400	400	397,44
CDPE17000450	450	269,17
CDPE17000500	500	351,71
CDPE17000630	630	714,56



Aplicación

**CUPE - CURVA 11°**

Con cuello largo para soldar con accesorios de alta seguridad FRIALEN, o soldadura a tope.

PE 100 SDR11 - Máxima presión de trabajo permitida 16 bar (agua) / 10 bar (gas)

Ref.	Ø	€/Ud.
CU11PE110090	90	84,02
CU11PE110110	110	111,87
CU11PE110125	125	124,25
CU11PE110140	140	140,18
CU11PE110160	160	160,08
CU11PE110180	180	267,52
CU11PE110200	200	324,11
CU11PE110225	225	386,90
CU11PE110250	250	463,85
CU11PE110280	280	567,31
CU11PE110315	315	688,47
CU11PE110355	355	1.271,26
CU11PE110400	400	1.525,51
CU11PE110450	450	1.874,38

PE 100 SDR17 - Máxima presión de trabajo permitida 10 bar (agua) / 5 bar (gas)

Ref.	Ø	€/Ud.
CU11PE170090	90	68,98
CU11PE170110	110	88,44
CU11PE170125	125	100,38
CU11PE170140	140	114,52
CU11PE170160	160	122,93
CU11PE170180	180	196,32
CU11PE170200	200	237,45
CU11PE170225	225	281,66
CU11PE170250	250	349,32
CU11PE170280	280	398,40
CU11PE170315	315	513,82
CU11PE170355	355	819,35
CU11PE170400	400	1.240,75
CU11PE170450	450	1.491,47

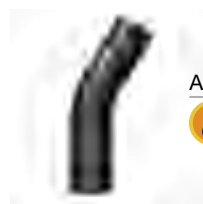

Aplicación

**CUPE - CURVA 22°**

Con cuello largo para soldar con accesorios de alta seguridad FRIALEN, o soldadura a tope.

PE 100 SDR11 - Máxima presión de trabajo permitida 16 bar (agua) / 10 bar (gas)

Ref.	Ø	€/Ud.
CU22PE110090	90	84,02
CU22PE110110	110	111,87
CU22PE110125	125	124,25
CU22PE110140	140	140,18
CU22PE110160	160	160,08
CU22PE110180	180	267,52
CU22PE110200	200	324,11
CU22PE110225	225	386,90
CU22PE110250	250	463,85
CU22PE110280	280	567,31
CU22PE110315	315	688,47
CU22PE110355	355	1.271,26
CU22PE110400	400	1.525,51
CU22PE110450	450	1.874,38

PE 100 SDR17 - Máxima presión de trabajo permitida 10 bar (agua) / 5 bar (gas)

Ref.	Ø	€/Ud.
CU22PE170090	90	68,98
CU22PE170110	110	88,44
CU22PE170125	125	100,38
CU22PE170140	140	114,52
CU22PE170160	160	122,93
CU22PE170180	180	196,32
CU22PE170200	200	237,45
CU22PE170225	225	281,66
CU22PE170250	250	349,32
CU22PE170280	280	398,40
CU22PE170315	315	513,82
CU22PE170355	355	819,35
CU22PE170400	400	1.240,75
CU22PE170450	450	1.491,47



Aplicación



CUPE - CURVA 30°

Con cuello largo para soldar con accesorios de alta seguridad FRIALEN, o soldadura a tope.

PE 100 SDR11 - Máxima presión de trabajo permitida 16 bar (agua) / 10 bar (gas)

Ref.	Ø	€/Ud.
CU30PE110090	90	84,02
CU30PE110110	110	111,87
CU30PE110125	125	124,25
CU30PE110140	140	140,18
CU30PE110160	160	160,08
CU30PE110180	180	267,52
CU30PE110200	200	324,11
CU30PE110225	225	386,90
CU30PE110250	250	463,85
CU30PE110280	280	567,31
CU30PE110315	315	688,47
CU30PE110355	355	1.271,26
CU30PE110400	400	1.525,51
CU30PE110450	450	1.874,38



Aplicación



CUPE - CURVA 45°

Con cuello largo para soldar con accesorios de alta seguridad FRIALEN, o soldadura a tope.

PE 100 SDR11 - Máxima presión de trabajo permitida 16 bar (agua) / 10 bar (gas)

Ref.	Ø	€/Ud.
CU45PE110090	90	84,02
CU45PE110110	110	111,87
CU45PE110125	125	124,25
CU45PE110140	140	140,18
CU45PE110160	160	160,08
CU45PE110180	180	267,52
CU45PE110200	200	324,11
CU45PE110225	225	386,90
CU45PE110250	250	463,85
CU45PE110280	280	567,31
CU45PE110315	315	688,47
CU45PE110355	355	1.271,26
CU45PE110400	400	1.525,51
CU45PE110450	450	1.874,38

PE 100 SDR17 - Máxima presión de trabajo permitida 10 bar (agua) / 5 bar (gas)

Ref.	Ø	€/Ud.
CU30PE170090	90	68,98
CU30PE170110	110	88,44
CU30PE170125	125	100,38
CU30PE170140	140	114,52
CU30PE170160	160	122,93
CU30PE170180	180	196,32
CU30PE170200	200	237,45
CU30PE170225	225	281,66
CU30PE170250	250	349,32
CU30PE170280	280	398,40
CU30PE170315	315	513,82
CU30PE170355	355	819,35
CU30PE170400	400	1.240,75
CU30PE170450	450	1.491,47

PE 100 SDR17 - Máxima presión de trabajo permitida 10 bar (agua) / 5 bar (gas)

Ref.	Ø	€/Ud.
CU45PE170090	90	68,98
CU45PE170110	110	88,44
CU45PE170125	125	100,38
CU45PE170140	140	114,52
CU45PE170160	160	122,93
CU45PE170180	180	196,32
CU45PE170200	200	237,45
CU45PE170225	225	281,66
CU45PE170250	250	349,32
CU45PE170280	280	398,40
CU45PE170315	315	513,82
CU45PE170355	355	819,35
CU45PE170400	400	1.240,75
CU45PE170450	450	1.491,47



Aplicación



CUPE - CURVA 60°

Con cuello largo para soldar con accesorios de alta seguridad FRIALEN, o soldadura a tope.

PE 100 SDR11 - Máxima presión de trabajo permitida 16 bar (agua) / 10 bar (gas)

Ref.	Ø	€/Ud.
CU60PE110090	90	84,02
CU60PE110110	110	111,87
CU60PE110125	125	124,25
CU60PE110140	140	140,18
CU60PE110160	160	160,08
CU60PE110180	180	267,52
CU60PE110200	200	324,11
CU60PE110225	225	386,90
CU60PE110250	250	463,85
CU60PE110280	280	567,31
CU60PE110315	315	688,47
CU60PE110355	355	1.271,26
CU60PE110400	400	1.525,51
CU60PE110450	450	1.874,38

PE 100 SDR17 - Máxima presión de trabajo permitida 10 bar (agua) / 5 bar (gas)

Ref.	Ø	€/Ud.
CU60PE170090	90	68,98
CU60PE170110	110	88,44
CU60PE170125	125	100,38
CU60PE170140	140	114,52
CU60PE170160	160	122,93
CU60PE170180	180	196,32
CU60PE170200	200	237,45
CU60PE170225	225	281,66
CU60PE170250	250	349,32
CU60PE170280	280	398,40
CU60PE170315	315	513,82
CU60PE170355	355	819,35
CU60PE170400	400	1.240,75
CU60PE170450	450	1.491,47



Aplicación



CUPE - CURVA 90°

Con cuello largo para soldar con accesorios de alta seguridad FRIALEN, o soldadura a tope.

PE 100 SDR11 - Máxima presión de trabajo permitida 16 bar (agua) / 10 bar (gas)

Ref.	Ø	€/Ud.
CU90PE110090	90	87,10
CU90PE110110	110	116,29
CU90PE110125	125	133,53
CU90PE110140	140	153,44
CU90PE110160	160	178,63
CU90PE110180	180	294,93
CU90PE110200	200	358,17
CU90PE110225	225	424,93
CU90PE110250	250	528,84
CU90PE110280	280	662,39
CU90PE110315	315	822,00
CU90PE110355	355	1.229,70
CU90PE110400	400	1.494,55
CU90PE110450	450	2.112,29

PE 100 SDR17 - Máxima presión de trabajo permitida 10 bar (agua) / 5 bar (gas)

Ref.	Ø	€/Ud.
CU90PE170090	90	71,19
CU90PE170110	110	91,53
CU90PE170125	125	106,13
CU90PE170140	140	122,48
CU90PE170160	160	134,42
CU90PE170180	180	214,90
CU90PE170200	200	258,67
CU90PE170225	225	304,66
CU90PE170250	250	395,31
CU90PE170280	280	458,98
CU90PE170315	315	599,15
CU90PE170355	355	817,14
CU90PE170400	400	1.218,20
CU90PE170450	450	1.724,05

Accesorios de PE

Accesorios de Polietileno inyectados cortos

INFRAESTRUCTURA





Aplicación



Aplicación

**TBE - TÉS IGUALES A 90° CORTAS**

Con cuello corto para soldadura a tope

PE 100 SDR11 - Máxima presión de trabajo permitida 16 bar (agua) / 10 bar (gas)

Ref.	Ø	€/Ud.
TBE11020	20	1,86
TBE11025	25	1,86
TBE11032	32	2,32
TBE11040	40	3,75
TBE11050	50	5,03
TBE11063	63	7,77
TBE11075	75	15,71
TBE11090	90	23,41
TBE11110	110	34,40
TBE11125	125	47,38
TBE11140	140	60,05
TBE11160	160	100,99
TBE11180	180	129,45
TBE11200	200	185,52
TBE11225	225	220,64
TBE11250	250	280,69
TBE11280	280	379,47
TBE11315	315	539,05
TBE11355	355	987,96
TBE11400	400	1.475,17
TBE11450	450	1.948,96
TBE11500	500	2.490,89

PE 100 SDR17 - Máxima presión de trabajo permitida 10 bar (agua) / 5 bar (gas)

Ref.	Ø	€/Ud.
TBE17050	50	4,45
TBE17063	63	6,07
TBE17075	75	12,40
TBE17090	90	17,63
TBE17110	110	29,26
TBE17125	125	40,52
TBE17140	140	47,88
TBE17160	160	89,97
TBE17180	180	110,60
TBE17200	200	150,98
TBE17225	225	177,28
TBE17250	250	235,23
TBE17280	280	265,93
TBE17315	315	353,69
TBE17355	355	833,97
TBE17400	400	1.139,80
TBE17450	450	1.585,12
TBE17500	500	2.039,90

TRBE - TÉS REDUCIDAS A 90° CORTAS

Con cuello corto para soldadura a tope

PE 100 SDR11 - Máxima presión de trabajo permitida 16 bar (agua) / 10 bar (gas)

Ref.	Ø	€/Ud.
TRBE11090050	90-50	34,96
TRBE11110032	110-32	50,26
TRBE111100500	110-50	51,30
TRBE11125063	125-63	71,80
TRBE11140063	140-63	90,10
TRBE11140075	140-75	90,10
TRBE11140090	140-90	91,52
TRBE11140110	140-110	91,52
TRBE11160110	160-110	161,07
TRBE11160125	160-125	161,07
TRBE11180063	180-63	188,56
TRBE11180075	180-75	188,56
TRBE11180125	180-125	194,62
TRBE11225110	225-110	341,94
TRBE11225125	225-125	341,94
TRBE11225160	225-160	355,46
TRBE11250160	250-160	442,23

PE 100 SDR17 - Máxima presión de trabajo permitida 10 bar (agua) / 5 bar (gas)

Ref.	Ø	€/Ud.
TRBE17110090	110-90	52,35
TRBE17140063	140-63	69,92
TRBE17140075	140-75	70,26
TRBE17140090	1409-90	71,40
TRBE17140110	140-110	72,85
TRBE17160110	160-110	142,58
TRBE17160125	160-125	142,58
TRBE17180063	180-63	161,27
TRBE17180075	180-75	161,27
TRBE17180125	180-125	166,20
TRBE17225110	225-110	285,21
TRBE17225125	225-125	285,21
TRBE17225160	225-160	285,21



Aplicación



**TRCB - TÉS REDUCIDAS
MECANIZADAS CORTAS**

Con cuello corto para soldadura a tope

PE 100 SDR11 - Máxima presión de trabajo permitida 16 bar (agua) / 10 bar (gas)

Ref.	Ø	€/Ud.
TRCB11280063	280-63	1.057,45
TRCB11280075	280-75	1.083,80
TRCB11280090	280-90	1.127,68
TRCB11280110	280-110	1.183,26
TRCB11280125	280-125	1.245,02
TRCB11280140	280-140	1.303,21
TRCB11280160	280-160	1.501,11
TRCB11280180	280-180	1.638,82
TRCB11280200	280-200	1.774,97
TRCB11280225	280-225	2.192,14
TRCB11315075	315-75	1.156,87
TRCB11315090	315-90	1.193,61
TRCB11315110	315-110	1.523,20
TRCB11315125	315-125	1.593,40
TRCB11315140	315-140	1.666,65
TRCB11315160	315-160	1.766,04
TRCB11315180	315-180	1.870,11
TRCB11315200	315-200	1.962,27
TRCB11315225	315-225	2.562,56
TRCB11315250	315-250	2.767,28
TRCB11355090	355-90	1.400,09
TRCB11355110	355-110	1.533,02
TRCB11355125	355-125	1.593,26
TRCB11355140	355-140	1.688,99
TRCB11355160	355-160	2.075,04
TRCB11355180	355-180	2.193,53
TRCB11355200	355-200	2.325,37
TRCB11355225	355-225	2.479,14
TRCB11355250	355-250	2.670,86
TRCB11355280	355-280	3.392,85
TRCB11400110	400-110	1.839,32
TRCB11400125	400-125	1.922,70
TRCB11400140	400-140	2.003,51
TRCB11400160	400-160	2.079,45
TRCB11400180	400-180	2.581,75
TRCB11400200	400-200	2.723,76
TRCB11400225	400-225	2.875,79
TRCB11400250	400-250	3.096,92
TRCB11400280	400-280	3.836,67
TRCB11400315	400-315	4.207,05
TRCB11450125	450-125	1.982,73
TRCB11450140	450-140	2.066,64
TRCB11450160	450-160	2.180,51
TRCB11450180	450-180	2.612,43
TRCB11450200	450-200	2.750,13
TRCB11450225	450-225	2.881,65
TRCB11450250	450-250	3.496,91

Ref.	Ø	€/Ud.
TRCB11450280	450-280	3.764,84
TRCB11450315	450-315	4.124,96
TRCB11450355	450-355	5.460,07
TRCB11500140	500-140	2.491,99
TRCB11500160	500-160	2.591,88
TRCB11500180	500-180	2.732,35
TRCB11500200	500-200	2.875,79
TRCB11500225	500-225	4.151,34
TRCB11500250	500-250	4.457,14
TRCB11500280	500-280	4.497,01
TRCB11500315	500-315	5.191,80
TRCB11500355	500-355	5.654,36
TRCB11500400	500-400	6.445,11
TRCB11560160	560-160	3.312,09
TRCB11560180	560-180	3.499,58
TRCB11560200	560-200	3.636,82
TRCB11560225	560-225	3.943,24
TRCB11560250	560-250	4.069,02
TRCB11560280	560-280	4.430,61
TRCB11560315	560-315	5.061,25
TRCB11560355	560-355	6.206,50
TRCB11560400	560-400	7.017,76
TRCB11560450	560-450	8.949,98
TRCB11560560	560-560	13.810,37
TRCB11630180	630-180	3.760,06
TRCB11630200	630-200	3.910,98
TRCB11630225	630-225	4.153,92
TRCB11630250	630-250	4.483,18
TRCB11630280	630-280	4.815,46
TRCB11630315	630-315	6.347,25
TRCB11630355	630-355	6.875,58
TRCB11630400	630-400	7.781,93
TRCB11630450	630-450	9.354,39
TRCB11630500	630-500	12.020,35
TRCB11630630	630-630	21.369,64
TRCB11710180	710-180	5.533,77
TRCB11710200	710-200	5.722,54
TRCB11710225	710-225	5.905,97
TRCB11710250	710-250	6.255,45
TRCB11710280	710-280	6.552,48
TRCB11710315	710-315	7.338,76
TRCB11710355	710-355	7.864,72
TRCB11710400	710-400	8.600,34
TRCB11710450	710-450	8.390,48
TRCB11710500	710-500	11.689,57
TRCB11710560	710-560	13.597,64
TRCB11710710	710-710	24.794,54



Aplicación



**TRCB - TÉS REDUCIDAS
MECANIZADAS CORTAS**

Con cuello corto para soldadura a tope

PE 100 SDR17 - Máxima presión de trabajo permitida 10 bar (agua) / 5 bar (gas)

Ref.	Ø	€/Ud.
TRCB17280063	280-63	1.017,58
TRCB17280075	280-75	1.043,02
TRCB17280090	280-90	1.085,30
TRCB17280110	280-110	1.138,61
TRCB17280125	280-125	1.198,03
TRCB17280140	280-140	1.254,11
TRCB17280160	280-160	1.444,56
TRCB17280180	280-180	1.577,06
TRCB17280200	280-200	1.708,11
TRCB17280225	280-225	2.109,40
TRCB17315075	315-75	1.113,36
TRCB17315090	315-90	1.148,60
TRCB17315110	315-110	1.465,82
TRCB17315125	315-125	1.533,51
TRCB17315140	315-140	1.428,99
TRCB17315160	315-160	1.699,50
TRCB17315180	315-180	1.799,56
TRCB17315200	315-200	1.888,38
TRCB17315225	315-225	2.465,80
TRCB17315250	315-250	2.662,95
TRCB17355090	355-90	1.347,16
TRCB17355110	355-110	1.475,24
TRCB17355125	355-125	1.533,02
TRCB17355140	355-140	1.625,34
TRCB17355160	355-160	1.996,70
TRCB17355180	355-180	2.110,96
TRCB17355200	355-200	2.237,72
TRCB17355225	355-225	2.385,80
TRCB17355250	355-250	2.570,17
TRCB17355280	355-280	3.264,98
TRCB17400110	400-110	1.769,87
TRCB17400125	400-125	1.850,43
TRCB17400140	400-140	1.927,95
TRCB17400160	400-160	2.001,12
TRCB17400180	400-180	2.484,39
TRCB17400200	400-200	2.621,11
TRCB17400225	400-225	2.767,44
TRCB17400250	400-250	2.980,28
TRCB17400280	400-280	3.691,94
TRCB17400315	400-315	4.048,41
TRCB17450125	450-125	1.907,92
TRCB17450140	450-140	1.988,68
TRCB17450160	450-160	2.098,39
TRCB17450180	450-180	2.513,93
TRCB17450200	450-200	2.646,45
TRCB17450225	450-225	2.773,17
TRCB17450250	450-250	3.365,03

Ref.	Ø	€/Ud.
TRCB17450280	450-280	3.622,65
TRCB17450315	450-315	3.969,46
TRCB17450355	450-355	5.254,21
TRCB17500140	500-140	2.398,29
TRCB17500160	500-160	2.494,39
TRCB17500180	500-180	2.629,39
TRCB17500200	500-200	2.767,44
TRCB17500225	500-225	3.994,70
TRCB17500250	500-250	4.289,04
TRCB17500280	500-280	4.327,54
TRCB17500315	500-315	4.996,10
TRCB17500355	500-355	5.441,18
TRCB17500400	500-400	6.202,21
TRCB17560160	560-160	3.187,31
TRCB17560180	560-180	3.367,58
TRCB17560200	560-200	3.499,73
TRCB17560225	560-225	3.794,70
TRCB17560250	560-250	3.915,65
TRCB17560280	560-280	4.263,47
TRCB17560315	560-315	3.281,79
TRCB17560355	560-355	5.972,37
TRCB17560400	560-400	6.753,13
TRCB17560450	560-450	8.612,56
TRCB17560560	560-560	13.289,66
TRCB17630180	630-180	3.618,39
TRCB17630200	630-200	3.763,55
TRCB17630225	630-225	3.997,25
TRCB17630250	630-250	4.314,12
TRCB17630280	630-280	4.633,92
TRCB17630315	630-315	6.108,02
TRCB17630355	630-355	6.616,52
TRCB17630400	630-400	7.488,55
TRCB17630450	630-450	9.001,59
TRCB17630500	630-500	11.567,11
TRCB17630630	630-630	20.563,99
TRCB17710180	710-180	5.325,24
TRCB17710200	710-200	5.506,81
TRCB17710225	710-225	5.683,22
TRCB17710250	710-250	6.019,54
TRCB17710280	710-280	6.305,44
TRCB17710315	710-315	7.062,10
TRCB17710355	710-355	7.568,13
TRCB17710400	710-400	8.276,12
TRCB17710450	710-450	9.602,81
TRCB17710500	710-500	11.248,98
TRCB17710560	710-560	13.085,11
TRCB17710710	710-710	23.859,73



Aplicación

**RBE - REDUCCIONES CONCÉNTRICAS CORTAS**

Con cuello corto para soldadura a tope

PE 100 SDR11 - Máxima presión de trabajo permitida 16 bar (agua) / 10 bar (gas)

Ref.	Ø	€/Ud.
RBE11025020	25-20	3,66
RBE11032020	32-20	4,27
RBE11032025	32-25	4,27
RBE11040020	40-20	4,88
RBE11040025	40-25	4,88
RBE11040032	40-32	4,88
RBE11050025	50-25	5,09
RBE11050032	50-32	5,09
RBE11050040	50-40	5,09
RBE11063032	63-32	6,17
RBE11063040	63-40	6,17
RBE11063050	63-50	6,17
RBE11075032	75-32	7,94
RBE11075040	75-40	7,94
RBE11075050	75-50	7,94
RBE11075063	75-63	7,94
RBE11090050	90-50	8,78
RBE11090063	90-63	8,78
RBE11090075	90-75	8,78
RBE11110050	110-50	11,22
RBE11110063	110-63	11,22
RBE11110075	110-75	11,22
RBE11110090	110-90	11,22
RBE11125063	125-63	14,42
RBE11125075	125-75	14,42
RBE11125090	125-90	14,42
RBE11125110	125-110	14,42
RBE11140075	140-75	17,45
RBE11140090	140-90	17,45
RBE11140110	140-110	17,45
RBE11140125	140-125	17,45
RBE11160090	160-90	20,42
RBE11160110	160-110	20,42
RBE11160125	160-125	20,42
RBE11160140	160-140	20,42
RBE11180090	180-90	32,08
RBE11180110	180-110	30,22
RBE11180125	180-125	27,83
RBE11180140	180-140	26,44
RBE11180160	180-160	25,24
RBE11200140	200-140	72,26
RBE11200160	200-160	41,37
RBE11200180	200-180	34,71

Ref.	Ø	€/Ud.
RBE11225140	225-140	86,35
RBE11225160	225-160	53,36
RBE11225180	225-180	62,11
RBE11225200	225-200	58,74
RBE11250160	250-160	86,70
RBE11250180	250-180	84,19
RBE11250200	250-200	79,77
RBE11250225	250-225	79,98
RBE11280200	280-200	110,16
RBE11280225	280-225	99,73
RBE11280250	280-250	96,02
RBE11315200	315-200	136,52
RBE11315225	315-225	120,74
RBE11315250	315-250	110,00
RBE11315280	315-280	103,05
RBE11355200	355-200	239,58
RBE11355225	355-225	230,37
RBE11355250	355-250	146,36
RBE11355280	355-280	131,10
RBE11355315	355-315	125,01
RBE11400225	400-225	228,64
RBE11400250	400-250	204,28
RBE11400280	400-280	693,68
RBE11400315	400-315	210,38
RBE11400355	400-355	146,36
RBE11450280	450-280	991,85
RBE11450315	450-315	880,24
RBE11450355	450-355	634,67
RBE11450400	450-400	213,42
RBE11500280	500-280	1.735,70
RBE11500315	500-315	365,90
RBE11500355	500-355	1.158,17
RBE11500400	500-400	304,91
RBE11500450	500-450	274,36
RBE11560355	560-355	2.006,62
RBE11560400	560-400	1.514,21
RBE11560450	560-450	922,40
RBE11560500	560-500	378,06
RBE11630355	630-355	2.792,76
RBE11630400	630-400	679,91
RBE11630450	630-450	2.046,85
RBE11630500	630-500	542,71
RBE11630560	630-560	451,23



Aplicación



RBE - REDUCCIONES CONCÉNTRICAS CORTAS

Con cuello corto para soldadura a tope

PE 100 SDR17 - Máxima presión de trabajo permitida 10 bar (agua) / 5 bar (gas)

Ref.	Ø	€/Ud.
RBE17050032	50-32	4,88
RBE17050040	50-40	4,88
RBE17063032	63-32	5,85
RBE17063040	63-40	5,85
RBE17063050	63-50	5,85
RBE17075032	75-32	7,52
RBE17075040	75-40	7,52
RBE17075050	75-50	7,52
RBE17075063	75-63	7,52
RBE17090050	90-50	8,40
RBE17090063	90-63	8,40
RBE17090075	90-75	8,40
RBE17110050	110-50	10,70
RBE17110063	110-63	10,70
RBE17110075	110-75	10,70
RBE17110090	110-90	10,70
RBE17125063	125-63	13,74
RBE17125075	125-75	13,74
RBE17125090	125-90	13,74
RBE17125110	125-110	13,74
RBE17140075	140-75	16,65
RBE17140090	140-90	16,65
RBE17140110	140-110	16,65
RBE17140125	140-125	16,65
RBE17160090	160-90	19,45
RBE17160110	160-110	19,45
RBE17160125	160-125	19,45
RBE17160140	160-140	19,45
RBE17180090	180-90	30,51
RBE17180110	180-110	28,76
RBE17180125	180-125	26,52
RBE17180140	180-140	25,19
RBE17180160	180-160	18,73
RBE17200140	200-140	68,83
RBE17200160	200-160	32,01
RBE17200180	200-180	29,32
RBE17225140	225-140	82,16
RBE17225160	225-160	54,42
RBE17225180	225-180	59,15
RBE17225200	225-200	41,63
RBE17250160	250-160	68,03
RBE17250180	250-180	80,21
RBE17250200	250-200	62,68
RBE17250225	250-225	58,19
RBE17280200	280-200	85,37
RBE17280225	280-225	97,80

Ref.	Ø	€/Ud.
RBE17280250	280-250	76,31
RBE17315200	315-200	129,97
RBE17315225	315-225	118,39
RBE17315250	315-250	107,96
RBE17315280	315-280	101,06
RBE17355200	355-200	235,05
RBE17355225	355-225	226,00
RBE17355250	355-250	105,18
RBE17355280	355-280	100,61
RBE17355315	355-315	87,18
RBE17400225	400-225	833,70
RBE17400250	400-250	152,45
RBE17400280	400-280	693,68
RBE17400315	400-315	181,45
RBE17400355	400-355	109,72
RBE17450280	450-280	991,85
RBE17450315	450-315	494,51
RBE17450355	450-355	880,24
RBE17450400	450-400	149,35
RBE17500280	500-280	1.735,70
RBE17500315	500-315	253,97
RBE17500355	500-355	1.057,91
RBE17500400	500-400	204,28
RBE17500450	500-450	198,18
RBE17560355	560-355	2.259,98
RBE17560400	560-400	1.417,27
RBE17560450	560-450	883,77
RBE17560500	560-500	250,02
RBE17630355	630-355	2.441,78
RBE17630400	630-400	533,58
RBE17630450	630-450	1.902,15
RBE17630500	630-500	392,13
RBE17630560	630-560	335,38
RBE17710500	710-500	692,91
RBE17710560	710-560	1.734,06
RBE17710630	70-630	498,03
RBE17800560	800-560	727,17
RBE17800630	800-630	850,66
RBE17800710	800-710	704,54
RBE17900630	900-630	1.454,36
RBE17900710	900-710	3.689,02
RBE17900800	900-800	939,84
RBE171000710	1000-710	5.709,02
RBE171000800	1000-800	4.801,78
RBE171000900	1000-900	3.920,77



Aplicación



REBE - REDUCCIONES EXCÉNTRICAS CORTAS

Con cuello corto para soldadura a tope

PE 100 SDR11 - Máxima presión de trabajo permitida 16 bar (agua) / 10 bar (gas)

Ref.	Ø	€/Ud.
REBE11160090	160-90	229,44
REBE11160110	160-110	205,88
REBE11160125	160-125	184,02
REBE11160140	160-140	162,15
REBE11180110	180-110	272,04
REBE11180125	180-125	241,62
REBE11180140	180-140	224,05
REBE11180160	180-160	206,16
REBE11200125	200-125	293,28
REBE11200140	200-140	266,62
REBE11200160	200-160	236,83
REBE11200180	200-180	224,05
REBE11225140	225-140	368,55
REBE11225160	225-160	341,01
REBE11225180	225-180	296,73
REBE11225200	225-200	270,04
REBE11250160	250-160	436,70
REBE11250180	250-180	421,05
REBE11250200	250-200	381,37
REBE11250225	250-225	328,57
REBE11280180	280-180	491,26
REBE11280200	280-200	438,42
REBE11280225	280-225	399,23
REBE11280250	280-250	354,08
REBE11315200	315-200	543,77
REBE11315225	315-225	480,72
REBE11315250	315-250	416,84
REBE11315280	315-280	377,33

PE 100 SDR17 - Máxima presión de trabajo permitida 10 bar (agua) / 5 bar (gas)

Ref.	Ø	€/Ud.
REBE17160090	160-90	218,41
REBE17160110	160-110	189,66
REBE17160125	160-125	172,63
REBE17160140	160-140	153,62
REBE17180110	180-110	259,24
REBE17180125	180-125	230,02
REBE17180140	180-140	209,56
REBE17180160	180-160	192,55
REBE17200125	200-125	279,40
REBE17200140	200-140	252,46
REBE17200160	200-160	222,60
REBE17200180	200-180	209,84
REBE17225140	225-140	350,68
REBE17225160	225-160	328,26
REBE17225180	225-180	286,48
REBE17225200	225-200	257,26
REBE17250160	250-160	416,29
REBE17250180	250-180	400,37
REBE17250200	250-200	366,84
REBE17250225	250-225	305,53
REBE17280180	280-180	467,64
REBE17280200	280-200	430,23
REBE17280225	280-225	387,29
REBE17280250	280-250	331,92
REBE17315200	315-200	517,91
REBE17315225	315-225	458,60
REBE17315250	315-250	401,19
REBE17315280	315-280	364,32



Aplicación



GBE - CURVAS CORTAS DE 90°

Con cuello corto para soldadura a tope

PE 100 SDR11 - Máxima presión de trabajo permitida 16 bar (agua) / 10 bar (gas)

Ref.	Ø	€/Ud.
GBE11020	20	2,32
GBE11025	25	2,42
GBE11032	32	2,48
GBE11040	40	3,25
GBE11050	50	4,07
GBE11063	63	5,85
GBE11075	75	8,10
GBE11090	90	11,72
GBE11110	110	22,27
GBE11125	125	31,44
GBE11140	140	41,99
GBE11160	160	51,19
GBE11180	180	60,60
GBE11200	200	90,30
GBE11225	225	107,69
GBE11250	250	207,30
GBE11280	280	269,56
GBE11315	315	372,08
GBE11355	355	853,57
GBE11400	400	1.172,09
GBE11450	450	1.538,05
GBE11500	500	1.984,08

PE 100 SDR17 - Máxima presión de trabajo permitida 10 bar (agua) / 5 bar (gas)

Ref.	Ø	€/Ud.
GBE17050	50	3,90
GBE17063	63	5,40
GBE17075	75	7,94
GBE17090	90	10,30
GBE17110	110	21,71
GBE17125	125	27,63
GBE17140	140	40,08
GBE17160	160	44,23
GBE17180	180	54,70
GBE17200	200	67,73
GBE17225	225	83,46
GBE17250	250	140,96
GBE17280	280	183,19
GBE17315	315	253,08
GBE17355	355	628,87
GBE17400	400	875,74
GBE17450	450	1.144,80
GBE17500	500	1.444,63



Aplicación



REBE - REDUCCIONES EXCÉNTRICAS CORTAS

Con cuello corto para soldadura a tope

PE 100 SDR11 - Máxima presión de trabajo permitida 10 bar (agua)

Ref.	Ø	€/Ud.
BBEC11020E	20	14,87
BBEC11025E	25	18,47
BBEC11032E	32	19,11
BBEC11040E	40	27,08
BBEC11050E	50	33,71
BBEC11063E	63	44,36
BBEC11075E	75	73,65
BBEC11110E	110	113,54



Aplicación



BBEL - UNIONES TRES PIEZAS LARGAS

Con cuello corto para soldadura a tope

PE 100 SDR11 - Máxima presión de trabajo permitida 10 bar (agua)

Ref.	Ø	€/Ud.
BBEL11020E	20	14,87
BBEL11025E	25	18,47
BBEL11032E	32	19,11
BBEL11040E	40	27,08
BBEL11050E	50	33,71
BBEL11063E	63	44,36
BBEL11075E	75	76,18
BBEL11110E	110	114,99



Aplicación



DBME - TERMINAL ROSCA HEMBRA LARGO

Con cuello corto para soldadura a tope

PE 100 SDR11 - Máxima presión de trabajo permitida 10 bar (agua)

Ref.	Ø x Rh	€/Ud.
DBME11020012	20 x 1/2"	6,17
DBME11025034	25 x 3/4"	8,00
DBME11032100	32 x 1"	9,39
DBME11040114	40 x 1 1/4"	10,98
DBME11050112	50 x 1 1/2"	13,78
DBME11063200	63 x 2"	16,35



Aplicación



KBFE - TERMINAL ROSCA MACHO CORTO

Con cuello corto para soldadura a tope

PE 100 SDR11 - Máxima presión de trabajo permitida 8 bar (agua)

Ref.	Ø x Rm	€/Ud.
KBFE11020012	20 x 1/2"	8,62
KBFE11025034	25 x 3/4"	10,52
KBFE11032100	32 x 1"	13,28
KBFE11040114	40 x 1 1/4"	14,79
KBFE11050112	50 x 1 1/2"	25,27
KBFE11063200	63 x 2"	29,78

Uniones y adaptadores brida
Carretes de desmontaje
Abrazaderas de reparación

Accesorios metálicos

INFRAESTRUCTURA





Aplicación



Válido para



AQUAFast - UNIONES

Ref.	Ø	Presión Máx. Trabajo (bar)	€/Ud.
70700000063	63	16	113,62
70700000075	75	16	124,93
70700000090	90	16	135,60
70700000110	110	16	147,65
70700000125	125	16	178,44
70700000140	140	16	200,51
70700000160	160	16	231,96
70700000180	180	16	335,44
70700000200	200	16	439,83
70700000225	225	16	545,10
70700000250	250	16	669,00
70700000280	280	16	802,92
70700000315	315	16	940,23

Material: Cuerpo de fundición revestido con Rilsan Nylon 11.

Anillo: Fundición Dúctil

Tornillos y Tuercas: Sheraplex.

EPDM para Aplicaciones en Agua



Aplicación



Válido para



AQUAFast - ADAPTADORES DE BRIDA

Ref.	Ø	Presión Máx. Trabajo (bar)	Brida		€/Ud.
			DN	Taladro PN	
70800000063	63	16	50 / 65	10 / 16	80,01
70800000075	75	16	65 / 80	10 / 16	85,89
70800000090	90	16	65 / 80	10 / 16	99,13
70800000110	110	16	100	10 / 16	110,80
70800000125	125	16	100 / 125	10 / 16	134,04
70800000140	140	16	125	10 / 16	156,54
70800000160	160	16	150	10 / 16	177,24
70800000180	180	16	150	10 / 16	234,31
70800000200	200	16	200	10 / 16	299,66
70800000225	225	16	200	10 / 16	363,40
70800000250	250	16	250	10 / 16	438,04
70800000280	280	16	250	10 / 16	526,15
70800000315	315	16	300	10 / 16	621,66

Material: Cuerpo de fundición revestido con Rilsan Nylon 11.

Anillo: Fundición Dúctil

Tornillos y Tuercas:

Sheraplex.

EPDM para Aplicaciones en Agua



Aplicación



Válido para



AQUAFast - UNIONES PARA GRANDES DIÁMETROS

Ref.	Ø	Presión Máx. Trabajo (bar)	€/Ud.
70700000355	355	16	2.927,06
70700000400	400	16	3.213,27
70700000450	450	16	4.310,88

Material: Cuerpo de fundición revestido con Rilsan Nylon 11

Anillo antitracción: Fundición Dúctil

Tornillos y tuercas: Acero Inoxidable

Junta: EPDM para Aplicaciones en Agua.

Ideal para tubos con ovalación

AQUAFast - ADAPTADORES DE BRIDA PARA GRANDES DIÁMETROS

Ref.	Ø	Presión Máx. Trabajo (bar)	Brida		€/Ud.
			DN	Taladro PN	
708000300355	355	16	300	10 / 16	1.808,75
708000350355	355	16	350	10 / 16	1.844,94
708000350400	400	16	350	10 / 16	2.085,86
708000400400	400	16	400	10 / 16	2.127,61
708000400450	450	16	400	10 / 16	2.922,12
708000450450	450	16	450	10 / 16	2.980,55
708000500450	450	16	500	10 / 16	3.040,15



Aplicación



Válido para



AQUAGRIP - ADAPTADORES DE BRIDA ANTITRACCIÓN-AUTOBLOCANTE DE GRAN DIÁMETRO

SDR11

Ref.	Ø Tubo	Brida		€/Ud.*
		DN	Taladro PN	
161355300110	355	300	10	Consultar
161355300100	355	300	16	3.607,23
161355350100	355	350	16	3.607,23
161400300100	400	300	16	5.718,10
161400350100	400	350	16	5.718,10
161400400110	400	400	10	5.718,10
161400400100	400	400	16	5.718,10
161450350100	450	350	16	7.351,39
161450400110	450	400	10	Consultar
161450400100	450	400	16	7.351,39
161450450110	450	450	10	7.001,14
161450450100	450	450	16	7.351,39
161450500110	450	500	10	Consultar

Material: Cuerpo de fundición revestido con Rilsan Nylon 11

Tornillos y tuercas: hasta d800 Fluoreno, d900 en adelante galvanizado

Junta: EPDM para Aplicaciones en Agua.

Ideal para tubos con ovalación



Aplicación



Válido para



AQUAGRIP - ADAPTADORES DE BRIDA ANTITRACCIÓN-AUTOBLOCANTE DE GRAN DIÁMETRO

SDR17/17,6

Ref.	Ø Tubo	Brida		€/Ud.*
		DN	Taladro PN	
161355350200	355	350	16	3.607,23
161400300200	400	300	16	5.718,10
161400350200	400	350	16	5.718,10
161400400210	400	400	10	5.718,10
161400400200	400	400	16	5.718,10
161450350200	450	350	16	7.351,39
161450400210	450	400	10	7.351,39
161450400200	450	400	16	7.351,39
161450450210	450	450	10	7.001,14
161450450200	450	450	16	7.351,39
161500450200	500	450	16	8.996,30
161500500210	500	500	10	8.996,30
161500500200	500	500	16	8.996,30
161560450200	560	450	16	11.849,52
161560500210	560	500	10	11.849,52
161560500200	560	500	16	11.849,52
161630500200	630	500	16	16.848,89
161630600210	630	600	10	16.848,89
161630600200	630	600	16	16.848,89
161710600210	710	600	10	Consultar
161710600200	710	600	16	21.344,56
161710700210	710	700	10	21.344,56
161710700200	710	700	16	21.344,56

Material: Cuerpo de fundición revestido con Rilsan Nylon 11
Tornillos y tuercas: hasta d800 Fluoreno, d900 en adelante galvanizado
Junta: EPDM para Aplicaciones en Agua. Ideal para tubos con ovalación

* Fabricación hasta 1600: otras medidas y/o PN consultar.



Aplicación



Válido para



MAXIFIT - UNIONES

Ref.	DN	Tolerancia (mm)	Presión Máx. de Trabajo (bar)		€/Ud.*
			Agua	Gas	
701000000005	40	047.9 - 059.5	16	6	60,45
701000000010	50	057.0 - 074.0	16	6	48,85
701000000015	65	063.0 - 085.0	16	6	52,93
701000000020	80	085.0 - 107.0	16	6	60,21
701000000030	100	107.0 - 132.0	16	6	72,60
701000000035	125	132.0 - 158.0	16	6	92,55
701000000045	150	158.0 - 184.0	16	6	97,75
701000000050	175	189.0 - 212.0	16	6	119,31
701000000055	200	218.0 - 244.0	16	6	131,81
701000000065	225	243.0 - 269.0	16	6	156,82
701000000070	250	266.0 - 295.0	16	6	176,35
701000000075	300	315.0 - 349.0	16	6	199,21
701000000090	350	351.0 - 368.0	16	6	713,98
701000000095	350	374.5 - 391.5	16	6	713,98
701000000096	350	386.0 - 403.0	16	6	713,98
701000000097	350	394.3 - 411.3	16	6	713,98
701000000098	400	404.8 - 421.8	16	6	759,26
701000000099	400	412.0 - 429.0	16	6	759,26
701000000100	400	418.2 - 435.2	16	6	759,26
701000000101	400	425.0 - 442.0	16	6	759,26
701000000102	400	434.5 - 451.5	16	6	759,26
701000000103	400	439.0 - 456.0	16	6	759,26
701000000104	450	447.0 - 464.0	16	6	812,60
701000000105	450	455.0 - 472.0	16	6	812,60
701000000106	450	467.0 - 484.0	16	6	812,60
701000000110	450	476.0 - 493.0	16	6	812,60
701000000111	450	487.0 - 504.3	16	6	812,60
701000000112	450	492.0 - 509.0	16	6	812,60
701000000115	450	501.9 - 518.9	16	6	812,60
701000000118	500	510.0 - 527.0	16	6	917,63
701000000119	500	515.0 - 532.0	16	6	917,63
701000000120	500	527.0 - 545.0	16	6	917,63
701000000121	500	546.0 - 563.0	16	6	917,63
701000000122	500	555.3 - 572.3	16	6	917,63
701000000122	500	565.0 - 582.0	16	6	917,63
7010000002122	500	582.2 - 599.2	16	6	917,63
7010000003122	550	593.0 - 610.0	16	6	983,25
701000000123	600	601.0 - 618.0	16	6	1.010,18
701000000124	600	613.0 - 630.0	16	6	1.010,18
701000000125	600	630.0 - 647.0	16	6	1.010,18
701000000126	600	654.0 - 671.0	16	6	1.010,18
701000000130	600	662.0 - 679.0	16	6	1.010,18
701000000131	600	675.0 - 692.0	16	6	1.010,18
701000000132	600	689.0 - 706.0	16	6	1.101,72
701000000133	600	695.0 - 712.0	16	6	1.101,72

* Precios con Junta de EPDM, para Nitrilo consultar

Material: Cuerpo de fundición revestido con Rilsan Nylon 11.

Revestimiento de tornillos y tuercas: Sheraplex.

Juntas: EPDM para Aplicaciones en Agua, Nitrilo para Aplicaciones en Gas.

MAXIFIT-XTRA - UNIONES

Uniones de gran tolerancia (iguales que Maxifit) pero con un 50% más de longitud para incrementar seguridad de unión.
Disponibles desde DN50 a DN300



Aplicación



Válido para



MAXISTEP - UNIONES REDUCIDAS

Ref.	DN	Tolerancia (mm)		Presión Máx. de Trabajo (bar)		€/Ud.
		Extremo Peq.	Extremo Gran.	Agua	Gas	
70300000010	050 / 065	057.0 - 074.0	063.0 - 085.0	16	6	150,60
70300000015	050 / 080	057.0 - 074.0	085.0 - 107.0	16	6	154,08
70300000016	065 / 080	063.0 - 085.0	085.0 - 107.0	16	6	159,68
70300000020	080 / 100	085.0 - 107.0	107.0 - 132.0	16	6	164,70
70300000040	100 / 125	107.0 - 132.0	132.0 - 158.0	16	6	172,43
70300000050	125 / 150	132.0 - 158.0	158.0 - 184.0	16	6	191,71
70300000065	150 / 175	158.0 - 184.0	189.0 - 212.0	16	6	227,22
70300000075	175 / 200	189.0 - 212.0	218.0 - 244.0	16	6	288,25
70300000080	200 / 225	218.0 - 244.0	243.0 - 269.0	16	6	331,67
70300000085	225 / 250	243.0 - 269.0	266.0 - 295.0	16	6	337,25
70300000090	300 / 350	315.0 - 332.0	351.0 - 368.0	16	6	1.346,82
70300000095	300 / 350	315.0 - 332.0	367.0 - 384.0	16	6	1.406,86
70300000100	350 / 350	351.0 - 368.0	374.5 - 391.5	16	6	1.590,60
70300000115	350 / 350	374.5 - 391.5	394.3 - 411.3	16	6	878,47
70300000116	350 / 400	374.5 - 391.5	412.0 - 429.0	16	6	1.744,25
70300000117	350 / 400	386.0 - 403.0	412.0 - 429.0	16	6	922,57
70300000118	350 / 400	394.3 - 411.3	404.8 - 421.8	16	6	1.715,10
703000002118	350 / 400	394.3 - 411.3	418.2 - 435.2	16	6	922,57
703000003118	350 / 400	394.3 - 411.3	425.0 - 442.0	16	6	1.796,33
70300000119	400 / 400	404.8 - 421.8	418.2 - 435.2	16	6	922,57
70300000120	400 / 400	404.8 - 421.8	425.0 - 442.0	16	6	939,50
70300000121	400 / 400	404.8 - 421.8	434.5 - 451.4	16	6	1.834,01
70300000122	400 / 400	412.0 - 429.0	425.0 - 442.0	16	6	1.796,33
70300000123	400 / 400	418.2 - 435.2	434.5 - 451.4	16	6	1.834,01
70300000125	400 / 400	425.0 - 442.0	434.5 - 451.4	16	6	939,50
70300000130	400 / 400	425.0 - 442.0	447.2 - 464.2	16	6	939,50
70300000131	400 / 400	439.0 - 456.0	467.0 - 484.0	16	6	1.009,62
70300000135	400 / 450	425.0 - 442.0	455.0 - 472.0	16	6	2.002,31
70300000136	400 / 450	425.0 - 442.0	476.0 - 493.0	16	6	2.048,93
70300000137	400 / 450	425.0 - 442.0	487.3 - 504.3	16	6	2.518,08
70300001137	400 / 500	425.0 - 442.0	555.3 - 572.3	16	6	2.561,12
703000002137	400 / 500	425.0 - 442.0	565.0 - 582.0	16	6	1.012,23
703000002138	450 / 450	447.2 - 464.2	455.0 - 472.0	16	6	1.918,09
70300000139	450 / 450	447.2 - 464.2	476.0 - 493.0	16	6	2.002,31
70300000140	450 / 450	476.0 - 493.0	487.3 - 504.3	16	6	1.116,53
70300000145	450 / 450	476.0 - 493.0	501.9 - 518.9	16	6	1.116,53
70300000150	450 / 450	476.0 - 493.0	510.0 - 527.0	16	6	1.116,53
70300000151	450 / 500	492.0 - 509.0	527.0 - 544.0	16	6	1.363,89
70300000154	500 / 500	510.0 - 527.0	527.0 - 544.0	16	6	1.363,89
70300000155	500 / 500	527.0 - 544.0	540.1 - 557.1	16	6	1.235,01
70300000160	500 / 500	527.0 - 544.0	555.3 - 572.3	16	6	1.235,01
70300000165	500 / 500	527.0 - 544.0	566.5 - 583.5	16	6	1.235,01
70300000170	500 / 500	527.0 - 544.0	582.2 - 599.2	16	6	1.235,01



Aplicación



Válido para

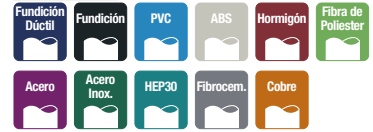

MAXISTEP - UNIONES REDUCIDAS

Ref.	DN	Tolerancia (mm)		Presión Máx. de Trabajo (bar)		€/Ud.
		Extremo Peq.	Extremo Gran.	Agua	Gas	
703000000171	500 / 600	527.0 - 544.0	598.0 - 615.0	16	6	2.706,13
7030000001171	500 / 600	527.0 - 544.0	601.0 - 618.0	16	6	2.720,55
7030000002171	500 / 500	546.0 - 563.0	590.5 - 607.5	16	6	1.299,24
7030000003171	500 / 500	565.0 - 582.0	582.2 - 599.2	16	6	2.636,34
7030000000172	600 / 600	601.0 - 618.0	630.0 - 647.0	16	6	1.299,24
7030000000173	600 / 600	601.0 - 618.0	645.2 - 662.2	16	6	1.299,24
7030000000174	600 / 600	618.0 - 635.0	630.0 - 647.0	16	6	1.299,24
7030000000175	600 / 600	630.0 - 647.0	645.2 - 662.2	16	6	1.299,24
7030000000180	600 / 600	630.0 - 647.0	662.0 - 679.0	16	6	1.299,24
7030000000185	600 / 600	630.0 - 647.0	675.0 - 692.0	16	6	1.299,24
7030000000186	600 / 600	654.0 - 671.0	710.0 - 727.0	16	6	1.515,89
7030000000190	700 / 700	733.0 - 750.0	741.0 - 758.0	16	6	1.665,39

* Precios con Junta de EPDM, para Nitrilo consultar



Aplicación



Válido para

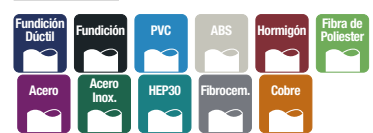

MAXIDAPTOR - ADAPTADORES DE BRIDA

Ref.	DN	Tolerancia (mm)	Brida		Presión Máx. de Trabajo (bar)		€/Ud.
			DN	Taladro PN	Agua	Gas	
7020000000005	50	057.0 - 074.0	50	10 / 16	16	6	51,24
7020000000010	65	063.0 - 085.0	60 / 65 / 80	10 / 16	16	6	66,69
7020000000020	80	085.0 - 107.0	80	10 / 16	16	6	67,82
7020000000030	100	107.0 - 132.0	100	10 / 16	16	6	71,13
7020000000035	125	132.2 - 158.0	125 / 150	10 / 16	16	6	96,36
7020000000045	150	158.0 - 184.0	150	10 / 16	16	6	98,39
7020000000050	175	189.0 - 212.0	200	10 / 16	16	6	131,25
7020000000055	200	218.0 - 244.0	200	10 / 16	16	6	137,74
7020000000060	225	243.0 - 269.0	250	10 / 16	16	6	172,22
7020000000065	250	266.0 - 295.0	250	10 / 16	16	6	182,34
7020000000070	300	315.0 - 349.0	300	10 / 16	16	6	215,56
7020000000075	350	348.5 - 365.5	350	16	16	6	882,51
7020000000080	350	351.0 - 368.0	350	10	16	6	882,51
7020000000084	350	351.0 - 368.0	350	16	16	6	882,51
7020000000085	350	374.5 - 391.5	350	10	16	6	882,51
7020000000090	350	374.5 - 391.5	350	16	16	6	882,51
7020000000095	350	394.3 - 411.3	350	10	16	6	882,51
7020000000100	350	394.3 - 411.3	350	16	16	6	882,51
7020000000101	350	394.3 - 411.3	400	10	16	6	982,59



Aplicación



Válido para



MAXIDAPTOR - ADAPTADORES DE BRIDA

Ref.	DN	Tolerancia (mm)	Brida			Presión Máx. de Trabajo (bar)		€/Ud.
			DN	Taladro PN	Agua	Gas		
702000000102	350	394.3 - 411.3	400	16	16	6	982,59	
702000000104	400	404.8 - 421.8	400	10	16	6	982,59	
702000000105	400	404.8 - 421.8	400	16	16	6	982,59	
702000000106	400	418.2 - 435.2	400	10	16	6	982,59	
702000000107	400	418.2 - 435.2	400	16	16	6	982,59	
702000000108	400	425.0 - 442.0	400	10	16	6	982,59	
702000000110	400	425.0 - 442.0	400	16	16	6	982,59	
702000000111	400	434.4 - 451.4	400	10	16	6	982,59	
702000000115	400	434.4 - 451.4	400	16	16	6	982,59	
702000000116	400	447.2 - 464.2	400	10	16	6	982,59	
702000000120	400	447.2 - 464.2	400	16	16	6	982,59	
702000000125	450	455.0 - 472.0	450	10	16	6	1.166,12	
702000000130	450	455.0 - 472.0	450	16	16	6	1.166,12	
702000000131	450	476.0 - 493.0	450	10	16	6	1.166,12	
702000000135	450	476.0 - 493.0	450	16	16	6	1.166,12	
702000000136	450	487.3 - 504.3	450	10	16	6	1.166,12	
702000000140	450	487.3 - 504.3	450	16	16	6	1.166,12	
702000000141	450	501.9 - 518.9	450	10	16	6	1.166,12	
702000000142	450	501.9 - 518.9	450	16	16	6	1.166,12	
702000000143	450	510.0 - 527.0	500	10	16	6	1.360,41	
702000000155	450	510.0 - 527.0	500	16	16	6	1.360,41	
702000000156	450	501.9 - 518.9	500	10	16	6	1.360,41	
702000000145	450	501.9 - 518.9	500	16	16	6	1.360,41	
702000000150	450	510.0 - 527.0	450	10	16	6	1.360,41	
702000000159	500	527.0 - 544.0	500	10	16	6	1.360,41	
702000000160	500	527.0 - 544.0	500	16	16	6	1.360,41	
702000000161	500	540.1 - 557.1	500	10	16	6	1.360,41	
702000000165	500	540.1 - 557.1	500	16	16	6	1.360,41	
702000000166	500	555.3 - 572.3	500	10	16	6	1.360,41	
702000000170	500	555.3 - 572.3	500	16	16	6	1.360,41	
702000000171	500	566.5 - 583.5	500	10	16	6	1.360,41	
702000000175	500	566.5 - 583.5	500	16	16	6	1.360,41	
702000000180	500	582.2 - 599.2	500	10	16	6	1.360,41	
702000000185	500	582.2 - 599.2	500	16	16	6	1.360,41	
702000000187	600	601.0 - 618.0	600	10	16	6	1.616,75	
702000000188	600	601.0 - 618.0	600	16	16	6	1.616,75	
702000000189	600	630.5 - 647.5	600	10	16	6	1.616,75	
702000000190	600	630.5 - 647.5	600	16	16	6	1.616,75	
702000000191	600	645.2 - 662.2	600	10	16	6	1.616,75	
702000000195	600	645.2 - 662.2	600	16	16	6	1.616,75	
702000000196	600	662.0 - 679.0	600	10	16	6	1.616,75	
702000000200	600	662.0 - 679.0	600	16	16	6	1.616,75	

* Precios con Junta de EPDM, para Nitrilo consultar



Aplicación



Válido para



MEGAFIT - UNIONES DE GRAN TOLERANCIA

Ref.	DN	Tolerancia (mm)	Presión Máx. de Trabajo (bar)		€/Ud.
			Agua	Gas	
70400000050	50	043.5 - 063.5	16	6	335,88
70400000065	65	063.0 - 083.7	16	6	345,78
70400000080	80	085.7 - 107.0	16	6	383,05
70400000100	100	107.2 - 133.2	16	6	443,76
70400000125	125	132.2 - 160.2	16	6	731,16
70400000150	150	158.2 - 192.2	16	6	766,51
70400000175	175	192.2 - 226.9	16	6	1.075,47
70400000200	200	218.1 - 252.1	16	6	1.197,10
70400000250	250	266.2 - 300.2	16	6	1.622,13
70400000300	300	315.0 - 349.0	16	6	1.788,57

* Precios con Junta de EPDM, para Nitrilo consultar

Permite mayor flexión angular entre tubos (hasta 8° en uniones y 4° en adaptadores de brida).

Recomendable para aplicaciones donde se puedan dar movimientos de terreno.

Material: Cuerpo de fundición revestido con Rilsan Nylon 11.

Revestimiento de tornillos y tuercas: Sheraplex.

Juntas: EPDM para Aplicaciones en Agua, Nitrilo para Aplicaciones en Gas.



Aplicación



Válido para



MEGADAPTOR - ADAPTADORES DE BRIDA DE GRAN TOLERANCIA

Ref.	DN	Tolerancia (mm)	Brida		Presión Máx. de Trabajo (bar)		€/Ud.
			DN	Taladro PN	Agua	Gas	
70500000050	50	043.5 - 063.5	50	10 / 16	10 / 16	6	254,29
70500000065	65	063.0 - 083.7	65	10 / 16	10 / 16	6	323,17
70500000080	80	085.7 - 107.0	80	10 / 16	10 / 16	6	359,12
70500000100	100	107.2 - 133.2	100	10 / 16	10 / 16	6	429,31
70500000125	125	132.2 - 160.2	125	10 / 16	10 / 16	6	569,92
70500000150	150	158.2 - 192.2	150	10 / 16	10 / 16	6	631,29
70500000175	175	192.2 - 226.9	200	10 / 16	10 / 16	6	741,13
70500000200	200	218.1 - 252.1	200	10 / 16	10 / 16	6	1.042,10
70500000250	250	266.2 - 300.2	250	10 / 16	10 / 16	6	1.360,55
70500000300	300	315.0 - 349.0	300	10 / 16	10 / 16	6	1.760,57

* Precios con Junta de EPDM, para Nitrilo consultar

Permite mayor flexión angular entre tubos (hasta 8° en uniones y 4° en adaptadores de brida).

Recomendable para aplicaciones donde se puedan dar movimientos de terreno.

Material: Cuerpo de fundición revestido con Rilsan Nylon 11.

Revestimiento de tornillos y tuercas: Sheraplex.

Juntas: EPDM para Aplicaciones en Agua, Nitrilo para Aplicaciones en Gas.



Aplicación



Válido para



ULTRAGRIP - UNIONES DE GRAN TOLERANCIA

Ref.	DN	Tolerancia (mm)	Presión Máx. de Trabajo (bar)		€/Ud.*
			Agua	Gas	
15005000010	40	043.5 - 063.5	16	4	220,24
15004000000	50	048.0 - 071.0	16	4	238,72
15006500020	65	063.0 - 083.7	16	4	257,31
15008000030	80	085.7 - 107.0	16	4	295,42
15010000040	100	107.2 - 133.2	16	4	347,53
15012500050	125	132.2 - 160.2	16	4	476,38
15015000060	150	158.2 - 192.2	16	4	593,17
15017500070	175	192.2 - 226.9	16	4	813,62
15020000080	200	218.1 - 256.0	16	4	883,56
15025000090	250	266.2 - 310.0	16	4	1.137,50
15030000100	300	315.0 - 356.0	16	4	1.352,25
15035000110	350	352.2 - 396.0	10	4	2.281,32
15040000120	400	398.2 - 442.0	10	4	2.455,91
15045000130	450	448.0 - 492.0	10	**	3.712,81
15050000140	500	498.0 - 552.0	10	**	4.473,19
15050000141	500	558.0 - 608.0	10	**	4.959,01
15060000150	600	604.0 - 648.0	10	**	5.514,16
15060000151	600	676.0 - 726.0	10	**	5.903,64

* Precios con Junta de EPDM, para Nitrilo consultar

** No apto para gas

Permite convertirla en no autoblocante.

Utiliza misma mordaza para todo tipo de materiales compatibles. Para aplicaciones en PE y PVC.

Material: Cuerpo de fundición revestido con Rilsan Nylon 11.

Revestimiento de tornillos: Capa de lubricante en seco.

Revestimiento de tuercas: Decromet.

Mordaza: Copolímero de Acetal.

Deflexión angular de hasta 8°.

Juntas: EPDM para Aplicaciones en Agua, Nitrilo para Aplicaciones en Gas.



Aplicación



Válido para



ULTRAGRIP - UNIONES REDUCIDAS DE GRAN TOLERANCIA

Ref.	DN	Tolerancia (mm)		Presión Máx. de Trabajo (bar)		€/Ud.*
		Extremo Peq.	Extremo Gran.	Agua	Gas	
152032040000	032 / 040	036.0 - 046.0	043.5 - 063.5	16	4	274,24
152080100000	080 / 100	085.7 - 107.0	107.2 - 133.2	16	4	395,09
152100125000	100 / 125	107.2 - 133.2	132.2 - 160.2	16	4	453,77
152100150000	100 / 150	107.2 - 133.2	158.2 - 192.2	16	4	570,02
152125150000	125 / 150	132.2 - 160.2	158.2 - 192.2	16	4	592,19
152150175000	150 / 175	158.2 - 192.2	192.9 - 226.2	16	4	773,23
152175200000	175 / 200	192.9 - 226.9	218.1 - 256.0	16	4	974,79
152200250000	200 / 250	218.1 - 256.0	266.2 - 310.0	16	4	1.144,51
152250300000	250 / 300	266.2 - 310.0	315.0 - 356.0	16	4	1.399,52
152400450000	400 / 450	398.0 - 442.0	448.0 - 492.0	10	**	2.921,56
152500500000	500 / 500	498.0 - 552.0	558.0 - 608.0	10	**	3.678,30
152600000000	600 / 600	604.0 - 648.0	676.0 - 726.0	10	**	4.954,77

* Precios con Junta de EPDM, para Nitrilo consultar.

** No apto para gas

Permite convertirla en no autoblocante.

Utiliza misma mordaza para todo tipo de materiales compatibles. Para aplicaciones en PE y PVC.

Material: Cuerpo de fundición revestido con Rilsan Nylon 11.

Revestimiento de tornillos: Capa de lubricante en seco.

Revestimiento de tuercas: Decromet.

Mordaza: Copolímero de Acetal.

Deflexión angular de hasta 8°.

Juntas: EPDM para Aplicaciones en Agua, Nitrilo para Aplicaciones en Gas.



Aplicación



Válido para



ULTRAGRIP - ADAPTADORES DE BRIDAS DE GRAN TOLERANCIA

Ref.	DN	Tolerancia (mm)	Brida		Presión Máx. de Trabajo (bar)		€/Ud.*
			DN	Taladro PN	Agua	Gas	
15105000010	40	043.5 - 063.5	50	10 / 16	16	4	189,83
15104000000	50	048.0 - 071.0	50	10 / 16	16	4	222,81
15106500020	65	063.0 - 083.7	65	10 / 16	16	4	231,82
15108000030	80	085.7 - 107.0	80	10 / 16	16	4	267,84
15110000040	100	107.2 - 133.2	100	10 / 16	16	4	331,33
15112500050	125	132.2 - 160.2	125	10 / 16	16	4	419,88
15115000060	150	158.2 - 192.2	150	10 / 16	16	4	501,99
15117500070	175	192.2 - 226.9	200	10 / 16	16	4	645,85
15120000080	200	218.1 - 256.0	200	10 / 16	16	4	696,64
15125000090	250	266.2 - 310.0	250	10 / 16	16	4	909,01
15130000100	300	315.0 - 356.0	300	10 / 16	16	4	1.125,65
15135000110	350	352.2 - 396.0	350	10 / 16	10	4	1.753,73
15140000120	400	398.2 - 442.0	400	10 / 16	10	4	2.001,13
15140000121	450	448.0 - 492.0	400	10 / 16	10	**	3.027,13
15150000130	500	498.0 - 552.0	500	10 / 16	10	**	3.603,74
15150000131	500	558.0 - 608.0	500	10 / 16	10	**	3.870,70
15160000140	600	604.0 - 648.0	600	10 / 16	10	**	4.422,51
15160000141	600	676.0 - 726.0	600	10 / 16	10	**	5.031,42

* Precios con Junta de EPDM, para Nitrilo consultar.

** No apto para gas

Permite convertirla en no autoblocante.

Utiliza misma mordaza para todo tipo de materiales compatibles. Para aplicaciones en PE y PVC.

Material: Cuerpo de fundición revestido con Rilsan Nylon 11.

Revestimiento de tornillos: Capa de lubricante en seco.

Revestimiento de tuercas: Decromet.

Mordaza: Copolímero de Acetal.

Deflexión angular de hasta 8°.

Juntas: EPDM para Aplicaciones en Agua, Nitrilo para Aplicaciones en Gas.



Aplicación



Válido para



ULTRAGRIP - TAPONES DE GRAN TOLERANCIA

Ref.	DN	Tolerancia (mm)	Presión Máx. de Trabajo (bar)		€/Ud.*
			Agua	Gas	
15305000000	50	043.5 - 063.5	16	4	445,85
15306500000	65	063.0 - 083.7	16	4	458,59
15308000000	80	085.7 - 107.0	16	4	485,62
15310000000	100	107.2 - 133.2	16	4	547,85
15312500000	125	132.2 - 160.2	16	4	776,12
15315000000	150	158.2 - 192.2	16	4	1.049,57
15317500000	175	192.2 - 226.9	16	4	1.196,51
15320000000	200	218.1 - 256.0	16	4	1.306,48
15325000000	250	266.2 - 310.0	16	4	1.598,98
15330000000	300	315.0 - 356.0	16	4	1.939,86

* Precios con Junta de EPDM, para Nitrilo consultar.

Permite convertirla en no autoblocante.

Utiliza misma mordaza para todo tipo de materiales compatibles. Para aplicaciones en PE y PVC.

Material: Cuerpo de fundición revestido con Rilsan Nylon 11.

Revestimiento de tornillos: Capa de lubricante en seco.

Revestimiento de tuercas: Decromet.

Mordaza: Copolímero de Acetal.

Deflexión angular de hasta 8°.

Juntas: EPDM para Aplicaciones en Agua, Nitrilo para Aplicaciones en Gas.



Aplicación



Válido para



ULTRAGRIP - PECAADAPTORS DE GRAN TOLERANCIA

Ref.	DN	Tolerancia (mm)		Presión Máx. de Trabajo (bar)		€/Ud.*
		Extr. Ultragrip	Extr. tubo PE	Agua	Gas	
154090080160	80 / 90 SDR11	085.7 - 107.0	90mm SDR11	16	4	865,97
154110100160	100 / 110 SDR11	107.2 - 133.2	110mm SDR11	16	4	1.418,76
154125100160	100 / 125 SDR11	107.2 - 133.2	125mm SDR11	16	4	1.418,76
154110125160	125 / 110 SDR11	132.2 - 160.2	110mm SDR11	16	4	1.708,25
154125125160	125 / 125 SDR11	132.2 - 160.2	125mm SDR11	16	4	1.708,25
154160150160	150 / 160 SDR11	158.2 - 192.2	160mm SDR11	16	4	1.846,75
154180150160	150 / 180 SDR11	158.2 - 192.2	180mm SDR11	16	4	1.846,75
154225200160	200 / 225 SDR11	218.1 - 256.0	225mm SDR11	16	4	2.649,38

* Precios con Junta de EPDM, para Nitrilo consultar.

Permite convertirla en no autoblocante.

Utiliza misma mordaza para todo tipo de materiales compatibles. Para aplicaciones en PE y PVC.

Material: Cuerpo de fundición revestido con Rilsan Nylon 11.

Revestimiento de tornillos: Capa de lubricante en seco.

Revestimiento de tuercas: Decromet.

Mordaza: Copolímero de Acetal.

Deflexión angular de hasta 8°.

Juntas: EPDM para Aplicaciones en Agua, Nitrilo para Aplicaciones en Gas.



Aplicación



Válido para



ULTRAGRIP - CASQUILLOS ALINEADORES DE ACERO

SDR11

Ref.	Ø	€/Ud.
153040011100	40	18,77
153050011100	50	23,53
153063011100	63	69,45
153075011100	75	72,27
153090011100	90	76,01
153110011100	110	81,05
153125011100	125	88,58
153140011100	140	94,56
153160011100	160	101,16
153180011100	180	110,61
153200011100	200	129,32
153225011100	225	143,96
153250011100	250	156,39
153280011100	280	173,85
153315011100	315	197,06
153355011100	355	223,79
153400011100	400	306,66
153450011100	450	616,89
153500011100	500	752,59
153560011100	560	888,02
153630011100	630	976,78
156710011100	710	1.074,49

SDR17

Ref.	Ø	€/Ud.
153063017100	63	69,45
153075017100	75	72,27
153090017100	90	76,01
153110017100	110	81,05
153125017100	125	88,58
153140017100	140	94,56
153160017100	160	101,16
153180017100	180	110,61
153200017100	200	129,32
153225017100	225	143,96
153250017100	250	156,39
153280017100	280	173,85
153315017100	315	197,06
153355017100	355	223,79
153400017100	400	306,66
153450017100	450	616,89
153500017100	500	752,59
153560017100	560	888,02
153630017100	630	976,78
153710017100	710	1.074,49

Para aplicaciones con PE y PVC es necesario el uso de casquillos alineadores en toda la gama ULTRAGRIP



Aplicación



Válido para



FLEXLOCK - UNIONES AUTOBLOCANTES

Ref.	DN	Ø Tubo	Material	Presión Máx. Trabajo (bar)	€/Ud.*
71200000050	50	60.3	Acero	16	345,37
71200000065	65	76.1	Acero	16	407,39
71200000080	80	88.9	Acero	16	420,28
71300000080	80	98.0	Fund.Dúctil	16	495,70
71200000100	100	114.3	Acero	16	540,87
71300000100	100	118.0	Fund.Dúctil	16	540,87
71200000150	150	168.3	Acero	16	754,74
71300000150	150	170.0	Fund.Dúctil	16	754,74
71200000200	200	219.1	Acero	16	1.191,90
71300000200	200	222.0	Fund.Dúctil	16	1.191,90
71400000250	250	273.0 & 274.0	Acero & Fund.Dúctil	10	2.257,77
71400000300	300	323.9 & 326.0	Acero & Fund.Dúctil	10	2.707,80

* Precios con Junta de EPDM, para Nitrilo consultar.

Material: Cuerpo de fundición revestido con Rilsan Nylon 11

Revestimiento de tornillos y tuercas: Sheraplex

Juntas: EPDM para Aplicaciones en Agua, Nitrilo para Aplicaciones en Gas



Aplicación



Válido para



FLEXLOCK - ADAPTADORES DE BRIDA AUTOBLOCANTES

Ref.	DN	Ø Tubo	Material	Pres. Máx. Trab. (bar)	Brida		€/Ud.*
					DN	Taladro PN	
71500000050	50	60.3	Acero	16	50	10/16	279,61
71500000065	65	76.1	Acero	16	60 & 65	10/16	376,88
71500000080	80	88.9	Acero	16	80	10/16	391,75
71600000080	80	98.0	Fund.Dúctil	16	80	10/16	391,75
71500000100	100	114.3	Acero	16	100	10/16	436,16
71600000100	100	118.0	Fund.Dúctil	16	100	10/16	436,16
71500000150	150	168.3	Acero	16	150	10/16	632,67
71600000150	150	170	Fund.Dúctil	16	150	10/16	632,67
715000010200	200	219.1	Acero	16	200	10	1.098,14
715000016200	200	219.1	Acero	16	200	16	1.098,14
716000010200	200	222.0	Fund.Dúctil	16	200	10	1.098,14
716000016200	200	222.0	Fund.Dúctil	16	200	16	1.098,14
717000000250	250	273.0 & 274.0	Acero & Fund.Dúctil	10	250	10/16	1.668,27
717000000300	300	323.9 & 326.0	Acero & Fund.Dúctil	10	300	10/16	2.009,65

* Precios con Junta de EPDM, para Nitrilo consultar.

Material: Cuerpo de fundición revestido con Rilsan Nylon 11

Revestimiento de tornillos y tuercas: Sheraplex

Juntas: EPDM para Aplicaciones en Agua, Nitrilo para Aplicaciones en Gas



Aplicación



Válido para



QUICKFIT - UNIONES

Ref.	DN	Ø Tubo	Presión Máx.Trabajo (bar)	€/Ud.*
720000040040	40	047.9 - 051.3	40	108,82
720000040050	50	059.5 - 063.3	40	139,18
720000040065	65	075.3 - 079.1	40	183,24
720000040080	80	088.1 - 091.9	40	199,71
721000040080	80	095.8 - 100.2	40	199,71
720000040100	100	107.2 - 111.0	40	241,95
721000040100	100	113.5 - 120.2	40	241,95
720000040125	125	138.9 - 142.7	40	310,36
720000025150	150	158.2 - 162.0	25	342,85
721000025150	150	167.5 - 172.3	25	342,85
720000025175	175	192.2 - 196.7	25	352,37
720000025200	200	218.3 - 224.4	25	402,02
720000025250	250	272.2 - 276.5	25	474,87
720000025300	300	323.1 - 328.6	25	580,17

* Precios con Junta de EPDM, para Nitrilo consultar.

Especialmente diseñados para grandes presiones (hasta 46 bar).

Material: Cuerpo de fundición revestido con Rilsan Nylon 11.

Revestimiento de tornillos y tuercas: Sheraplex.

Juntas: EPDM para Aplicaciones en Agua, Nitrilo para Aplicaciones en Gas.



Aplicación



Válido para

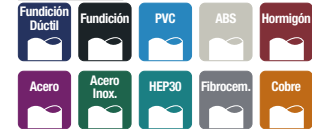

QUICKFIT - ADAPTADORES DE BRIDA

Ref.	DN	Ø Tubo	Material	Brida		€/Ud.*
				DN	Taladro PN	
722000000050	50	059.5 - 063.3	Acero/PVC /PVCu	50	10/16/25/40	203,91
722000000065	65	075.3 - 079.1	Acero	65	10/16	264,69
722000000080	80	088.1 - 091.9	Acero/PVC /PVCu	80	10/16/25/40	305,05
723000000080	80	095.8 - 100.2	Fund. Dúctil	80	10/16/25/40	305,05
722000000100	100	107.2 - 111.0	Acero/PVC	100	10/16	324,55
723000000100	100	113.5 - 120.2	Acero/PVCu/Fund. Dúctil	100	10/16	324,55
722000000125	125	138.9 - 142.7	Acero/PVC/PVCu	125	10/16	363,30
722000000150	150	158.2 - 162.0	Acero/PVC/PVCu	150	10/16	413,85
723000000150	150	167.5 - 172.3	Acero/Fund. Dúctil	150	10/16	413,85
722000000200	200	192.2 - 196.7	Acero/PVCu	200	10/16	490,87
723000000200	200	218.3 - 224.4	Acero/PVCu/Fund. Dúctil	200	10/16	565,79
722000000250	250	272.2 - 276.5	Acero/PVCu/Fund. Dúctil	250	10/16	746,49
722000000300	300	323.1 - 328.6	Acero/PVCu/Fund. Dúctil	300	10/16	906,55

* Precios con Junta de EPDM, para Nitrilo consultar.

Especialmente diseñados para grandes presiones (hasta 46 bar).

Material: Cuerpo de fundición revestido con Rilsan Nylon 11.

Revestimiento de tornillos y tuercas: Sheraplex.

Juntas: EPDM para Aplicaciones en Agua, Nitrilo para Aplicaciones en Gas.



Aplicación



Válido para



MANGUITOS DE UNIÓN DE GRAN DIÁMETRO PARA TUBERÍA DE FUNDICIÓN

Ref.	Ø Tubo	Presión Máx.Trabajo (bar)	€/Ud.
70100000378	378	29,2	469,81
70100000429	429	25,8	592,30
70100000480	480	23,1	592,30
70100000481	480	29	1.519,07
70100000532	532	26,1	639,37
70100000635	635	22	865,04
70100000636	635	25,2	1.941,46
70100000738	738	21,7	896,08
70100000739	738	28	5.378,73
70100000842	842	18,9	1.071,50
70100000845	842	25	2.924,76
70100000843	842	29,1	Consultar
70100000945	945	21,9	1.737,99
70100000946	945	25,9	Consultar
70100001048	1048	18,3	1.816,86
70100001049	1048	26,8	4.747,10
70100001152	1152	24,4	4.686,42
70100001255	1255	25,2	4.917,21
70100001462	1462	23,9	4.307,57

Soluciones a medida, no autoblocantes.

Uniones: desde d 355.6 hasta 2032.

Uniones reducidas desde d 355.6 hasta 1220.

Adaptadores de Bidas desde d 355.6 hasta 1668.

Para unión de diferentes materiales.

No apto para PE.

Juntas y Revestimientos: en función de la aplicación.



Aplicación



Válido para



ADAPTADORES DE BRIDA DE GRAN DIÁMETRO PARA TUBERÍA DE FUNDICIÓN

Ref.	Ø Tubo	Brida		€/Ud.
		DN	Taladro PN	
702000000378	378	350	10	874,85
702000000379	378	350	16	874,85
702000000380	378	350	25	1.106,84
702000000429	429	400	10	1.040,94
702000000430	429	400	16	1.040,94
702000000431	429	400	25	1.395,32
702000000480	480	450	10	1.188,14
702000000481	480	450	16	1.188,14
702000000482	480	450	25	1.588,41
702000000532	532	500	10	1.279,89
702000000533	532	500	16	1.279,89
702000000534	532	500	25	1.742,72
702000000635	635	600	10	1.674,38
702000000636	635	600	16	1.674,38
702000000637	635	600	25	2.241,93
702000000738	738	700	10	1.934,64
702000000739	738	700	16	1.934,64
702000000740	738	700	25	4.072,96
702000000842	842	800	10	2.180,69
702000000843	842	800	16	2.180,69
702000000844	842	800	25	4.582,79
702000000945	945	900	10	3.102,68
702000000946	945	900	16	3.102,68
702000000947	945	900	25	Consultar
702000001048	1048	1000	10	3.548,94
702000001049	1048	1000	16	3.548,94
702000001050	1048	1000	25	8.589,81
702000001152	1152	1100	10	Consultar
702000001153	1152	1100	16	5.841,56
702000001154	1152	1100	25	Consultar
702000001255	1255	1200	10	7.206,20
702000001256	1255	1200	16	7.206,20
702000001257	1255	1200	25	9.928,61
702000001462	1462	1400	10	8.784,49
702000001463	1462	1400	16	8.784,49

Soluciones a medida, no autoblocantes.

Uniones: desde d 355.6 hasta 2032.

Uniones reducidas desde d 355.6 hasta 1220.

Adaptadores de Bridas desde d 355.6 hasta 1668.

Para unión de diferentes materiales. No apto para PE.

Juntas y Revestimientos: en función de la aplicación.



Aplicación



Válido para



CARRETES DE DESMONTAJE

Ref.	DN	PN Brida	€/Ud.*
170000050100	50	10 / 16	252,69
170000065100	65	10 / 16	255,88
170000080100	80	10 / 16	306,60
170000100100	100	10 / 16	335,48
170000125100	125	10 / 16	418,41
170000150100	150	10 / 16	502,47
170000200110	200	10	656,60
170000200116	200	16	729,09
170000250110	250	10	880,44
170000250116	250	16	978,09
170000300110	300	10	1.034,52
170000300116	300	16	1.150,09
170000350110	350	10	1.298,88
170000350116	350	16	1.443,86
170000400110	400	10	1.592,82
170000400116	400	16	1.771,50
170000450110	450	10	1.771,50
170000450116	450	16	1.974,09
170000500110	500	10	2.158,78
170000500116	500	16	2.403,08
170000600110	600	10	2.619,55
170000600116	600	16	2.917,48
170000700110	700	10	3.100,16
170000700116	700	16	3.459,65
170000800110	800	10	4.081,30
170000800116	800	16	4.530,11
170000900110	900	10	4.853,82
170000900116	900	16	5.390,07
170001000110	1000	10	8.646,26
170001000116	1000	16	9.603,94
170001100110	1100	10	12.305,38
170001100116	1100	16	16.332,07
170001200110	1200	10	21.879,84
170001200116	1200	16	25.866,29
170001400110	1400	10	28.580,88
170001400116	1400	16	30.753,50
170001500110	1500	10	34.330,47
170001500116	1500	16	36.912,82
170001600110	1600	10	40.573,41
170001600116	1600	16	43.627,45
170001800110	1800	10	54.601,00
170001800116	1800	16	58.684,74
170002000110	2000	10	68.728,40
170002000116	2000	16	73.949,66

* Otras presiones consultar

Para válvulas, bombas y medidores.
Posibilidad de otras dimensiones y PN bajo petición.

Material: Acero revestido con Rilsan Nylon 11.



Aplicación



Válido para



EASICLAMP ABRAZADERAS DE REPARACIÓN

Ref.	DN	Tolerancia (mm)	Presión Máx. Trabajo (bar)	€/Ud.*
710000000005	50	066.0 - 075.0	16	121,33
710000000010	65	075.0 - 084.0	16	145,59
710000000015*	80	092.3 - 103.0	16	199,20
710000000020*	100	115.0 - 125.6	16	217,06
710000000025	125	141.0 - 153.9	16	176,12
710000000030*	150	166.0 - 181.2	16	251,72
710000000035	175	200.0 - 210.0	16	239,34
710000000040	200	216.5 - 226.0	16	257,54
710000000045	200	230.2 - 243.5	16	280,52
710000000050	250	269.0 - 294.0	16	Consultar
710000000055	300	323.0 - 349.0	16	558,89

* Versión Remote

Material: Cuerpo de fundición revestido con Rilsan Nylon 11.

Revestimiento de tornillos y tuercas: Sheraplex.

Juntas: EPDM tipo "gofre" antifugas.

Hasta DN 1200 - Consultar



Aplicación



Válido para



EASITAP OUTLET ABRAZADERAS DE REPARACIÓN CON SALIDA ROSCADA

Ref.	DN	Tolerancia (mm)	Presión Máx. Trabajo (bar)	Toma	€/Ud.*
711000000015*	80	092.3 - 103.0	16	2"	481,71
711000000020*	100	115.0 - 125.6	16	2"	527,63
711000000030*	150	166.0 - 181.2	16	2"	523,35

* Versión Remote

Material: Cuerpo de fundición revestido con Rilsan Nylon 11.

Revestimiento de tornillos y tuercas: Sheraplex.

Juntas: EPDM tipo "gofre" antifugas.



Aplicación



Válido para



UNIVERSAL EASITEE - TE EMBRIDADA

Ref.	DN	Tolerancia	Pres. Máx. Trab. (bar)	Brida		€/Ud.*
				DN	Taladro PN	
730080000160	80	085.4 - 103.0	16	80	10/16	414,02
730100000160	100	111.8 - 129.4	16	80/100	10/16	558,31
730150100160	150	165.2 - 184.4	16	80/100	10/16	724,77
730150150160	150	165.2 - 184.4	16	150	10/16	767,50
730200100160	200	215.9 - 239.7	16	80/100	10/16	923,43
730200150160	200	215.9 - 239.7	16	150	10/16	976,96
730200200160	200	215.9 - 239.7	16	200	16	1.039,82
730250200160	250	269.2 - 293.5	16	200	16	1.654,73
730250250160	250	269.2 - 293.5	16	250	16	1.762,48
730300100160	300	323.1 - 349.0	16	80/100	10/16	2.089,77
730300150160	300	323.1 - 349.0	16	150	16	2.145,51
730300200160	300	323.1 - 349.0	16	200	16	2.200,04
730300250160	300	323.1 - 349.0	16	250	16	2.301,24
730300000160	300	323.1 - 349.0	16	300	16	2.364,44

Material: Cuerpo de fundición revestido con Rilsan Nylon 11.

Revestimiento de tornillos y tuercas: Fluoreno.

Juntas: EPDM tipo "gofre" antifugas.



Aplicación



Válido para



EASYCOLLAR

Collarín de reparación para tuberías" enchufe-campana".
Desde d300 a d1200.

Material: Cuerpo de fundición revestido con Rilsan Nylon 11.

Revestimiento de tornillos y tuercas: Sheraplex.

Juntas: EPDM.



Aplicación



Válido para



HANDICLAMP - ABRAZADERAS SIMPLES DE REPARACIÓN EN ACERO INOXIDABLE

DN	Tolerancia (mm)	Presión Máx. de Trabajo (bar)		L-150 mm		L-200 mm	
		Agua	Gas	Ref.	E/Ud	Ref.	E/Ud
32	044.0 - 048.0	24	6	706000000004	60,16	706000200004	69,03
32	048.0 - 052.0	24	6	706000000005	61,65	706000200005	69,64
40	054.0 - 058.0	24	6	706000000010	61,65	706000200010	69,64
40	058.0 - 064.0	24	6	706000000014	62,73	706000200014	72,85
50	060.0 - 067.0	24	6	706000000015	62,73	706000200015	72,85
50	063.0 - 070.0	24	6	706000000016	62,73	706000200016	72,85
50	068.0 - 076.0	24	6	706000000020	64,25	706000200020	74,36
65	075.0 - 083.0	24	6	706000000035	66,60	706000200035	77,16
65	082.0 - 089.0	20	5	706000000040	66,60	706000200040	77,16
80	087.0 - 096.0	20	5	706000000045	67,74	706000200045	77,88
80	095.0 - 105.0	20	5	706000000055	68,62	706000200055	78,65
90	102.0 - 112.0	20	5	706000150060	68,91	706000000060	88,21
100	113.0 - 123.0	20	5	706000150075	70,88	706000000075	90,44
100	120.0 - 130.0	16	4	706000150085	80,64	706000000085	92,86
125	132.0 - 142.0	16	4	-	-	706000000095	94,28
125	135.0 - 145.0	16	4	-	-	706000000100	94,28
125	147.0 - 157.0	16	4	-	-	706000000105	98,94
150	151.0 - 161.0	16	4	-	-	706000000110	99,74
150	160.0 - 170.0	16	4	-	-	706000000115	99,74
150	167.0 - 178.0	16	4	-	-	706000000125	101,57
150	176.0 - 187.0	16	4	-	-	706000000140	106,17
175	186.0 - 196.0	16	4	-	-	706000000150	112,89
175	193.0 - 203.0	16	4	-	-	706000000155	113,28
175	200.0 - 210.0	16	4	-	-	706000000160	113,28
200	215.0 - 225.0	16	4	-	-	706000000170	123,42
200	219.0 - 229.0	16	4	-	-	706000000175	123,42
225	230.0 - 240.0	10	2,5	-	-	-	-
225	237.0 - 247.0	10	2,5	-	-	-	-
225	240.0 - 250.0	10	2,5	-	-	-	-
225	250.0 - 260.0	10	2,5	-	-	-	-
225	257.0 - 267.0	10	2,5	-	-	-	-
225	261.0 - 271.0	10	2,5	-	-	-	-
250	270.0 - 280.0	10	2,5	-	-	-	-
250	280.0 - 291.0	6	1,5	-	-	-	-
250	290.0 - 300.0	6	1,5	-	-	-	-
300	300.0 - 310.0	6	1,5	-	-	-	-
300	310.0 - 320.0	6	1,5	-	-	-	-
300	315.0 - 325.0	6	1,5	-	-	-	-
300	320.0 - 330.0	6	1,5	-	-	-	-
300	330.0 - 340.0	6	1,5	-	-	-	-
300	340.0 - 350.0	6	1,5	-	-	-	-
300	350.0 - 360.0	6	1,5	-	-	-	-

También disponibles en L-300 mm y L-400 mm



Aplicación



Válido para



HANDICLAMP - ABRAZADERAS DOBLES DE REPARACIÓN EN ACERO INOXIDABLE

DN	Tolerancia (mm)	Presión Máx. de Trabajo (bar)		L-200 mm		L-300 mm	
		Agua	Gas	Ref.	E/Ud	Ref.	E/Ud
80	088.0 - 110.0	20	5	70600000335	137,95	706000300335	204,33
100	108.0 - 128.0	20	5	70600000337	140,61	706000300337	210,47
100	113.0 - 133.0	20	5	70600000338	145,26	706000300338	217,63
100	120.0 - 140.0	20	5	70600000339	145,25	706000300339	213,46
125	130.0 - 150.0	16	4	70600000340	149,10	706000300340	217,51
125	140.0 - 160.0	16	4	70600000342	150,98	706000300342	223,64
150	150.0 - 170.0	16	4	70600000364	154,28	706000300364	229,66
150	159.0 - 180.0	16	4	70600000343	156,31	706000300343	232,12
150	168.0 - 189.0	16	4	70600000346	157,62	706000300346	234,88
150	170.0 - 190.0	16	4	70600000347	157,81	706000300347	234,22
150	175.0 - 195.0	16	4	70600000357	159,22	706000300357	235,45
175	190.0 - 210.0	16	4	70600000348	160,49	706000300348	240,62
200	205.0 - 225.0	16	4	70600000349	177,88	706000300349	236,95
200	210.0 - 230.0	16	4	70600000350	177,88	706000300350	241,62
200	216.0 - 238.0	16	4	70600000351	178,69	706000300351	244,37
200	220.0 - 242.0	10	2,5	70600000352	178,96	706000300352	246,72
225	240.0 - 260.0	10	2,5	70600000353	185,00	706000300353	265,50
225	243.0 - 263.0	10	2,5	70600000354	187,93	706000300354	271,36
225	255.0 - 275.0	10	2,5	706000200205	191,42	706000000205	269,77
250	272.0 - 292.0	10	2,5	706000200215	198,47	706000000215	267,43
250	282.0 - 302.0	6	1,5	706000200220	206,57	706000000220	271,27
250	295.0 - 315.0	6	1,5	706000200225	218,74	706000000225	269,14
300	307.0 - 327.0	6	1,5	-	-	706000000229	269,77
300	315.0 - 335.0	6	1,5	-	-	706000000230	293,05
300	319.0 - 339.0	6	1,5	-	-	706000000234	293,05
300	322.0 - 344.0	6	1,5	-	-	706000000235	307,50
300	333.0 - 353.0	6	1,5	-	-	706000000413	309,29
300	341.0 - 361.0	6	1,5	-	-	706000000362	327,42
350	365.0 - 385.0	5	1,3	-	-	706000000363	341,79

También disponibles en L-300 mm y L-400 mm



Aplicación



Válido para



HANDICLAMP - ABRAZADERAS TRIPLES DE REPARACIÓN EN ACERO INOXIDABLE (L-400)

Ref.	Tolerancia	€/Ud.*
706000000240	340.0 - 370.0	Consultar
706000000423	385.0 - 415.0	511,08
706000000245	395.0 - 425.0	591,19
706000000250	440.0 - 470.0	607,53
706000000255	475.0 - 505.0	979,89
706000000260	530.0 - 560.0	1.175,87
706000000421	535.0 - 565.0	1.871,35

Válvulas

Trampillones

Accesorios

Ventosas

Hidrantes y bocas de riego

Collarines, abrazaderas, tomas en carga

Bridas

Válvulas y accesorios de fundición

INFRAESTRUCTURA





Válvulas y accesorios de fundición

Válvulas de compuerta



* Para válvulas de cierre elástico
** ACS sólo para válvulas azules



* Para válvulas de cierre elástico
** ACS sólo para válvulas azules

NEXUS - VÁLVULAS DE COMPUERTA DE CIERRE ELÁSTICO CON BRIDAS

Serie 14 - PN16

Referencia	DN	€/Ud.
10729010	50	113,52
10729015	65	141,74
10729020	80	147,65
10729025	100	183,00
10729030	125	268,30
10729035	150	299,62
10729045	200	511,78
10729055	250	Consultar
10729065	300	Consultar

Disponible en PN10 y PN16

Con eje en acero inoxidable AISI 316 L +10%



También disponible en color rojo para saneamiento y aguas residuales. **PRECIOS CONSULTAR**

NEXUS - VÁLVULAS DE COMPUERTA DE CIERRE ELÁSTICO CON BRIDAS

Serie 15 - PN16

Referencia	DN	€/Ud.
10733010	50	128,41
10733015	65	146,09
10733020	80	164,70
10733025	100	199,76
10733030	125	300,87
10733035	150	353,91
10733045	200	584,68
10733055	250	Consultar
10733065	300	Consultar

Disponible en PN10 y PN16

Con eje en acero inoxidable AISI 316 L +10%



También disponible en color rojo para saneamiento y aguas residuales. **PRECIOS CONSULTAR**



* Para válvulas de cierre elástico
** ACS sólo para válvulas azules



También disponible en color rojo para saneamiento y aguas residuales. **PRECIOS CONSULTAR**
Cierre izquierda disponible bajo pedido

MODELO 3000 - VÁLVULAS DE COMPUERTA DE CIERRE ELÁSTICO CON BRIDAS

Serie 14 - PN16

Referencia	DN	€/Ud.
666040000001	40	123,76
666050000001	50	123,76
666060000001	60	155,09
666065000001	65	155,09
666080000001	80	163,14
666100000001	100	198,82
666125000001	125	294,34
666150000001	150	328,77
666200000001	200	586,21

Referencia	DN	€/Ud.
666250000001	250	893,29
666300000001	300	1.281,00
666350000001	350	3.070,68
666400000001	400	3.846,11
666450000001	450	6.420,50
666500000001	500	6.947,79

Disponible en PN10 y PN16

Con eje en acero inoxidable AISI 316 L +10%

Cierre izquierda disponible bajo pedido



* Para válvulas de cierre elástico
** ACS sólo para válvulas azules

NEXUS BLOCKPLUS - VÁLVULAS DE COMPUERTA DE CIERRE ELÁSTICO CON EXTREMOS ANTITRACCIÓN PARA TUBOS DE PE/PVC

PN16

Referencia	DN	DN ext. Tubo	€/Ud.
10720700	50	63	364,46
10720705	65	75	415,48
10720710	80	90	459,21
10720714	100	110	583,12
10720720	125	125	801,79
10720725	150	160	932,99
10720730	200	200	1.384,91

Con eje en acero inoxidable AISI 316 L +10%



* Para válvulas de cierre elástico
** ACS sólo para válvulas azules

MODELO 3000 - VÁLVULAS DE COMPUERTA DE CIERRE ELÁSTICO CON BRIDAS

Serie 15 - PN25

Referencia	DN	€/Ud.
666040025001	40	257,43
666050025001	50	257,43
666060025001	60	291,56
666065025001	65	291,56
666080025001	80	347,39
666100025001	100	406,32
666125025001	125	586,21
666150025001	150	688,58
666200025001	200	998,74
666250025001	250	1.600,48
666300025001	300	2.329,37

Con eje en acero inoxidable AISI 316 L +10%
Cierre izquierda disponible bajo pedido



* Para válvulas de cierre elástico
** ACS sólo para válvulas azules



También disponible en color rojo para saneamiento y aguas residuales. **PRECIOS CONSULTAR**
Cierre izquierda disponible bajo pedido

MODELO 3000 - VÁLVULAS DE COMPUERTA DE CIERRE ELÁSTICO CON BRIDAS

Serie 15 - PN16

Referencia	DN	€/Ud.
666040000002	40	141,12
666050000002	50	141,12
666060000002	60	161,29
666065000002	65	161,29
666080000002	80	181,44
666100000002	100	220,22
666125000002	125	331,88
666150000002	150	387,71
666200000002	200	645,15

Referencia	DN	€/Ud.
666250000002	250	1.011,16
666300000002	300	1.662,50
666350000002	350	3.486,30
666400000002	400	4.032,20
666450000002	450	7.003,62
666500000002	500	7.552,61
666600000002	600	12.096,60

Disponible en PN10 y PN16
Con eje en acero inoxidable AISI 316 L +10%
Cierre izquierda disponible bajo pedido



* Para válvulas de cierre elástico
** ACS sólo para válvulas azules

MODELO 3000 - VÁLVULAS DE COMPUERTA DE CIERRE ELÁSTICO CON BRIDAS PARA ACTUADORES ELÉCTRICOS

Serie 14 - PN16

Referencia	DN	€/Ud.
666040000005	40	276,99
666050000005	50	301,76
666060000005	60	346,96
666065000005	65	346,96
666080000005	80	392,15
666100000005	100	456,28
666125000005	125	638,52
666150000005	150	765,34
666200000005	200	1.090,43
666250000005	250	1.626,90
666300000005	300	2.205,64
666350000005	350	4.490,01
666400000005	400	5.612,51
666450000005	450	10.423,24
666500000005	500	12.026,82

Disponible en PN10 y PN16

Con eje en acero inoxidable AISI 316 L +10%



También disponible en color rojo para saneamiento y aguas residuales. **PRECIOS CONSULTAR**



* Para válvulas de cierre elástico
** ACS sólo para válvulas azules

MODELO 3000 - VÁLVULAS DE COMPUERTA DE CIERRE ELÁSTICO CON BRIDAS PARA ACTUADORES ELÉCTRICOS - CON ACTUADOR AUMA

Serie 14 - PN16

Referencia	DN	€/Ud.
10725500A	40	3.936,05
10725510A	50	3.936,05
10725520A	60	3.936,05
10725530A	65	3.936,05
10725540A	80	3.936,05
10725550A	100	4.810,73
10725560A	125	4.956,51
10725570A	150	5.102,29
CONSULTAR	200	5.539,62
CONSULTAR	250	7.872,10
CONSULTAR	300	8.455,22
CONSULTAR	350	11.516,59
CONSULTAR	400	12.099,71
CONSULTAR	450	16.764,64
CONSULTAR	500	18.368,22

Disponible en PN10 y PN16

Con eje en acero inoxidable AISI 316 +6%



También disponible en color rojo para saneamiento y aguas residuales. **PRECIOS CONSULTAR**



* Para válvulas de cierre elástico
** ACS sólo para válvulas azules

MODELO 3000 - VÁLVULAS DE COMPUERTA DE CIERRE ELÁSTICO CON BRIDAS PARA ACTUADORES ELÉCTRICOS

Serie 15 - PN16

Referencia	DN	€/Ud.
666040000004	40	364,46
666050000004	50	374,65
666060000004	60	419,84
666065000004	65	419,84
666080000004	80	456,28
666100000004	100	546,67
666125000004	125	784,30
666150000004	150	911,12
666200000004	200	1.508,81
666250000004	250	2.514,70
666300000004	300	3.520,57
666350000004	350	7.536,80
666400000004	400	9.781,81
666450000004	450	12.026,82
666500000004	500	12.828,60
666600000004	600	19.242,90

Disponible en PN10 y PN16

Con eje en acero inoxidable AISI 316 L +10%



También disponible en color rojo para saneamiento y aguas residuales. **PRECIOS CONSULTAR**



* Para válvulas de cierre elástico
** ACS sólo para válvulas azules

MODELO 3000 - VÁLVULAS DE COMPUERTA DE CIERRE ELÁSTICO CON BRIDAS PARA ACTUADORES ELÉCTRICOS - CON ACTUADOR AUMA

Serie 15 - PN16

Referencia	DN	€/Ud.
10726500A	40	4.008,94
10726510A	50	4.008,94
10726520A	60	4.008,94
10726530A	65	4.008,94
10726540A	80	4.008,94
10726550A	100	4.941,92
10726560A	125	5.102,29
10726570A	150	5.248,07
CONSULTAR	200	5.976,96
CONSULTAR	250	8.892,54
CONSULTAR	300	9.767,23
CONSULTAR	350	14.577,96
CONSULTAR	400	16.035,75
CONSULTAR	450	18.222,45
CONSULTAR	500	19.097,13
CONSULTAR	600	27.552,34

Disponible en PN10 y PN16

Con eje en acero inoxidable AISI 316 +6%



También disponible en color rojo para saneamiento y aguas residuales. **PRECIOS CONSULTAR**

Válvulas y accesorios de fundición
Válvulas de compuerta / Válvulas de cierre



* Para válvulas de cierre elástico
** ACS sólo para válvulas azules

MODELO 3000 - VÁLVULAS DE COMPUERTA DE CIERRE ELÁSTICO CON BRIDAS PARA ACTUADORES ELÉCTRICOS

Serie 15 - PN25

Referencia	DN	€/Ud.
666040025004	40	411,10
666050025004	50	411,10
666060025004	60	456,28
666065025004	65	456,28
666080025004	80	546,67
666100025004	100	638,52
666125025004	125	957,78
666150025004	150	1.056,90
666200025004	200	1.676,47
666250025004	250	2.682,34
666300025004	300	3.855,86

Con eje en acero inoxidable AISI 316 L +10%



* Para válvulas de cierre elástico
** ACS sólo para válvulas azules



MODELO 3000 - VÁLVULAS DE CIERRE ELÁSTICO CON ACTUADORES NEUMÁTICOS

Serie 14 - PN16

Referencia	DN	€/Ud.
10725501	40	3.352,92
10725511	50	3.352,92
10725521	60	3.352,92
10725531	65	3.352,92
10725541	80	4.664,94
10725551	100	4.737,84
10725561	125	5.539,61
10725571	150	5.539,61
10725581	200	5.831,18
10725591	250	10.204,57
10725601	300	13.120,15

Disponible en PN10 y PN16

Con eje en acero inoxidable AISI 316 L +10%

También disponible en color rojo para saneamiento y aguas residuales. **PRECIOS CONSULTAR**



* Para válvulas de cierre elástico
** ACS sólo para válvulas azules

MODELO 3000 - VÁLVULAS DE COMPUERTA DE CIERRE ELÁSTICO CON BRIDAS PARA ACTUADORES ELÉCTRICOS - CON ACTUADOR AUMA

Serie 15 - PN25

Referencia	DN	€/Ud.
10726700A	40	4.096,40
10726710A	50	4.096,40
10726720A	60	4.096,40
10726730A	65	4.096,40
10726740A	80	4.096,40
10726750A	100	5.248,07
10726760A	125	6.122,74
10726770A	150	6.997,42
10726780A	200	7.726,31
10726790A	250	8.746,78
10726800A	300	10.641,91

Con eje en acero inoxidable AISI 316 +6%
Actuador Eléctrico con control AUMA MATIC:
Hasta DN 150 +1.580,00 €
Desde DN 200 hasta DN500 +1.825,00 €



* Para válvulas de cierre elástico
** ACS sólo para válvulas azules



MODELO 3000 - VÁLVULAS DE CIERRE ELÁSTICO CON ACTUADORES NEUMÁTICOS

Serie 15 - PN16

Referencia	DN	€/Ud.
10727200	40	3.498,71
10727205	50	3.498,71
10727210	60	3.498,71
10727215	65	3.498,71
10727220	80	4.810,73
10727225	100	4.883,62
10727230	125	5.685,40
10727235	150	5.685,40
10727240	200	6.122,74
10727245	250	10.933,47
10727255	300	13.849,07

Disponible en PN10 y PN16

Con eje en acero inoxidable AISI 316 +10%

También disponible en color rojo para saneamiento y aguas residuales. **PRECIOS CONSULTAR**

* Para válvulas de cierre elástico
** ACS sólo para válvulas azules



* Para válvulas de cierre elástico
** ACS sólo para válvulas azules

MODELO 3000 - OTRAS VÁLVULAS CON BRIDAS

Serie 14 - PN16

Referencia	DN	€/Ud.
66604000007	40	381,94
66605000007	50	381,94
66606000007	60	422,76
66606500007	65	422,76
66608000007	80	459,21
66610000007	100	510,22
66612500007	125	656,01
66615000007	150	758,05
66620000007	200	1.093,35
66625000007	250	1.632,72
66630000007	300	2.135,66
66635000007	350	4.300,51
66640000007	400	5.320,94
66645000007	450	9.767,23
66650000007	500	11.953,82



* Para válvulas de cierre elástico
** ACS sólo para válvulas azules

MODELO 3000 - OTRAS VÁLVULAS CON BRIDAS

Serie 14 - PN16

Referencia	DN	€/Ud.
66604000008	40	615,19
66605000008	50	615,19
66606000008	60	714,31
66606500008	65	714,31
66608000008	80	749,30
66610000008	100	762,43
66612500008	125	927,15
66615000008	150	937,36
66620000008	200	1.462,18
66625000008	250	1.995,71
66630000008	300	2.708,59
66635000008	350	5.205,78
66640000008	400	6.772,92
66645000008	450	11.063,22
66650000008	500	12.681,37



MODELO 3000 - VÁLVULAS DE COMPUERTA METÁLICA

PN40

Referencia	DN	€/Ud.
66604004008	40	397,98
66605004008	50	451,90
66606004008	60	527,72
66606504008	65	527,72
66608004008	80	696,83
66610004008	100	962,15
66612504008	125	1.300,36
66615004008	150	1.682,28
66620004008	200	2.787,30

Referencia	DN	€/Ud.
66625004008	250	4.224,69
66630004008	300	5.124,16
66635004008	350	9.223,47
66640004008	400	12.432,07
66645004008	450	13.647,87
66650004008	500	22.260,53
66660004008	600	26.690,77
66670004008	700	46.795,24



* Para válvulas de cierre elástico
** ACS sólo para válvulas azules

MODELO 3000 - VÁLVULAS DE CIERRE ELÁSTICO CON DISTINTAS CONEXIONES

PN10 - PN16 - Con extremos lisos

Referencia	DN	€/Ud.
666050000021	50	240,54
666060000021	60	276,99
666080000021	80	291,56
666100000021	100	364,46
666125000021	125	641,43
666150000021	150	699,74
666200000021	200	1.093,35
666250000021	250	1.603,57
666300000021	300	2.186,69
666350000021	350	6.560,08
666400000021	400	8.163,66
666450000021	450	Consultar
666500000021	500	11.662,37

Con eje en acero inoxidable AISI 316 L +10%



* Para válvulas de cierre elástico
** ACS sólo para válvulas azules

MODELO 3000 - VÁLVULAS DE CIERRE ELÁSTICO CON DISTINTAS CONEXIONES

PN10 - PN16 - Con bocas para PVC

Referencia	DN	Ø Ext.PVC	€/Ud.
666050000010	40	50	196,80
666063000010	50	63	196,80
666075000010	65	75	227,42
666090000010	80	90	263,87
666110000010	100	110	306,14
666125000010	125	125	481,06
666140000010	125	140	510,22
666160000010	150	160	583,12
666200000010	200	200	918,41
666250000010	250	250	1.093,35
666315000010	300	315	1.603,57
666400000010	400	400	2.332,48
666500000010	500	500	4.898,20

Con eje en acero inoxidable AISI 316 L +10%



También disponible en color rojo para saneamiento y aguas residuales. **PRECIOS CONSULTAR**



* Para válvulas de cierre elástico
** ACS sólo para válvulas azules

MODELO 3000 - VÁLVULAS DE CIERRE ELÁSTICO CON DISTINTAS CONEXIONES

PN10 - PN16 - Con extremos en PE 100

Referencia	DN	Ø Ext. PE	€/Ud.
666032000020	25	32	247,83
666040000020	32	40	262,40
666050000020	40	50	291,56
666063000020	50	63	320,72
666075000020	65	75	364,46
666090000020	80	90	437,34
666110000020	100	110	583,12
666125000020	125	125	728,89
666140000020	125	140	1.035,03
666160000020	150	160	1.035,03
666180000020	150	180	1.457,81
666200000020	200	200	1.603,57
666225000020	200	225	2.332,48
666250000020	250	250	2.449,09
666280000020	250	280	3.644,49
666315000020	300	315	4.387,96
666400000020	400	400	14.577,96

Imagen sup.: Modelo SEC.XXI (desde DN 32 a DN 50)

Imagen inf.: Modelo 3000 (desde DN 63 a DN 400)



SÉCULO XXI - VÁLVULAS DE ACOMETIDA REGISTRO CON UNIONES ROSCADAS

PN10 - PN16

Referencia	Ø x Rh	€/Ud.
666020025002	20 - ¾"	61,11
666025032002	25 - 1"	61,11
666032040002	32 - 1 ¼"	92,11
666040050002	40 - 1 ½"	92,11
666050063002	50 - 2"	114,13

Con eje en acero inoxidable AISI 316 L +10%



SÉCULO XXI - VÁLVULAS DE ACOMETIDA REGISTRO CON UNIONES ROSCADAS

PN10 - PN16

Referencia	Ø x R	€/Ud.
666025032003	25/ 1"- 1 ¼"	123,92
666032040003	32/1 ¼" - 2"	145,78
666040050003	40/ 1 ½" - 2"	174,94
666050063003	50/ 2" - 2"	218,67

Con eje en acero inoxidable AISI 316 L +10%



SÉCULO XXI - VÁLVULAS DE ACOMETIDA
REGISTRO CON UNIONES PARA TUBO PE

PN10 - PN16

Referencia	DN	Ø Ext.PVC	€/Ud.
666020025004	20	25	88,92
666025032004	25	32	91,84
666032040004	32	40	105,81
666040050004	40	50	138,49
666050063004	50	63	167,64

Con eje en acero inoxidable AISI 316 L +10%



SÉCULO XXI - VÁLVULAS DE ACOMETIDA
REGISTRO CON EXTREMOS MIXTOS: ROSCADO
ANGULAR Y PARA TUBO PE

PN10 - PN16

Referencia	Ø x Rm	Ø Ext.PVC	€/Ud.
666025032005	25 - 1 ¼"	32	135,57
666032040005	32 - 2"	40	153,07
666040050005	40 - 2"	50	189,51
666050063005	50 - 2"	63	218,67

Con eje en acero inoxidable AISI 316 L +10%



SÉCULO XXI - VÁLVULAS DE ACOMETIDA
REGISTRO CON EXTREMOS MIXTOS: ROSCADO
RECTO Y PARA TUBO PE

PN10 - PN16

Referencia	Ø x R	Ø Ext.PVC	€/Ud.
666025032006	25 - 1"	32	145,78
666025114006	25 - 1 ¼"	32	160,35
666032040006	32 - 1 ¼"	40	174,94
666040050106	40 - 1 ½"	50	204,10
666050063006	50 - 2"	63	262,40

Con eje en acero inoxidable AISI 316 L +10%



SÉCULO XXI - VÁLVULAS DE ACOMETIDA
REGISTRO CON EXTREMOS MIXTOS: ROSCADO
MACHO Y HEMBRA PARA TUBO PE

PN10 - PN16

Referencia	Ø x R	€/Ud.
10721350	25 - 1"	160,35

Con eje en acero inoxidable AISI 316 L +10%



ESPÁTULAS DE EXTRACCIÓN DE PE

Referencia	Ø	€/Ud.
666ESP000025	25	301,76
666ESP000032	32	301,76
666ESP000040	40	301,76
666ESP000050	50	335,30
666ESP000063	63	408,19



TRAMPILLONES MODELO TELESCÓPICO

Referencia	Modelo	€/Ud.
E139EBAREC	CUADRADO	38,07
E139EBARER	REDONDO	38,07
E139EBAREH	HEXAGONAL	38,07
E737CLEBAC	LLAVE DE CIERRE	72,52



circular



triangular



cuadrado



hexagonal



octogonal

TRAMPILLONES DE FUNDICIÓN

Referencia	Modelo	€/Ud.
666TRACIR000	CIRCULAR FUCOLI CON CADENA	36,44
666TRACIR001	CIRCULAR FUCOLI SIN CADENA	32,07
666TRATRI000	TRIANGULAR FUCOLI CON CADENA	48,10
666TRATRI001	TRIANGULAR FUCOLI SIN CADENA	37,90
666TRACUA000	CUADRADO FUCOLI CON CADENA	48,10
666TRACUA001	CUADRADO FUCOLI SIN CADENA	37,90
666TRAHEX000	HEXAGONAL EPAL CON CADENA	27,69
666TRAHEX001	HEXAGONAL EPAL SIN CADENA	24,79
666TRAOCT000	OCTOGONAL FUCOLI CON CADENA	51,03
666TRAOCT001	OCTOGONAL FUCOLI SIN CADENA	39,36

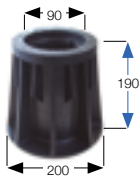

Un solo cuerpo



3 tapas diferentes = Reducción de stocks



TRAMPILLONES COMPOSITE

Referencia	Modelo	€/Ud.
E139EBA4ER	REDONDO	20,66
E139EBA4EC	CUADRADO	20,66
E139EBA4EE	HEXAGONAL	20,66
E737CLEBAC	LLAVE DE CIERRE	72,52



CUADRADILLO

Referencia	DN	€/Ud.
666020050027	20-¾"/25-1"/32-1 ¼"/40-1 ½"/50-2"	13,12
666040050027	40-50	13,12
666060080027	60-65-80	13,12
666100150027	100-125-150	13,12
666200200027	200	16,04
666250300027	250-300	17,50
666350500027	350-400-450-500	33,53
666600600027	600	72,89



VOLANTE

Referencia	DN	€/Ud.
666020050008	20-¾"/25-1"/32-1 ¼"/40-1 ½"/50-2"	15,51
666040050006	40-50	15,51
666065080006	60-65-80	17,05
666100100006	100	17,05
666125150006	125-150	31,01
666200200006	200	62,04
666250250006	250	86,85
666300300006	300	102,35
666350400006	350-400	124,07
666450500006	450-500	155,09
666600600006	600	217,11



OBTURADOR ANTIRROBO

Referencia	DN	€/Ud.
10720101	20-¼"/25-1"/32-1 ¼"/40-1 ½"/50-2"	72,89
	Otros DN	CONSULTAR



LLAVE PARA OBTURADOR ANTIRROBO

Referencia	DN	€/Ud.
10720100	20-¼"/25-1"/32-1 ¼"/40-1 ½"/50-2"	466,49
	Otros DN	CONSULTAR



EJE TELESCÓPICO 1 METRO

Referencia	DN	€/Ud.
666020050013	20-25-32-40-50	64,21
666040050013	40 - 50	64,21
666060080013	60-65-80	64,21
666100100013	100	64,21
666125150013	125-150	64,21
666200200013	200	64,21
666250300013	250-300	85,30
666350350013	350	85,30
666400400013	400	119,72
666450500013	450/500	120,04
666350500013	350 HASTA 500	120,04
666600600013	600	125,63



LLAVE DE MANIOBRA PARA VÁLVULAS

Referencia	€/Ud.
10701005	145,78



VÁLVULAS DE COMPUERTA DE CIERRE ELÁSTICO MODELO 3000 PARA GAS

Serie 14 - PN10-16

Referencia	Ø	€/Ud.
666063G10020	63	656,01
666075G10020	75	728,89
666090G10020	90	874,68
666110G10020	110	1.020,46
666125G10020	125	1.312,02
666160G10020	160	1.676,47
666200G10020	200	2.915,59
666250G10020	250	3.498,71
666315G10020	315	7.288,97

Con extremos de PE SDR11-SDR17



VÁLVULAS DE COMPUERTA DE CIERRE ELÁSTICO MODELO 3000 PARA GAS

Serie 14 - PN10-16

Referencia	DN	PN Brida	€/Ud.
666040G00001	40	10/16	364,46
666050G00001	50	10/16	364,46
666060G00001	60	10/16	393,62
666065G00001	65	10/16	393,62
666080G00001	80	10/16	408,19
666100G00001	100	10/16	473,77
666125G00001	125	10/16	801,79
666150G00001	150	10/16	801,79
666200G10001	200	10	1.239,14
666200G00001	200	16	1.239,14
666250G10001	250	10	1.851,39
666250G00001	250	16	1.851,39
666300G10001	300	10	2.696,91
666300G00001	300	16	2.696,91



VÁLVULAS DE COMPUERTA DE CIERRE ELÁSTICO MODELO 3000 PARA GAS

Serie 15 - PN10-16

Referencia	DN	PN Brida	€/Ud.
666040G00002	40	10/16	393,62
666050G00002	50	10/16	393,62
666060G00002	60	10/16	437,34
666065G00002	65	10/16	437,34
666080G00002	80	10/16	473,77
666100G00002	100	42644	568,53
666125G00002	125	10/16	947,57
666150G00002	150	10/16	947,57
666200G10002	200	10	1.603,57
666200G00002	200	16	1.603,57
666250G10002	250	10	2.478,24
666250G00002	250	16	2.478,24
666300G10002	300	10	3.352,92
666300G00002	300	16	3.352,92

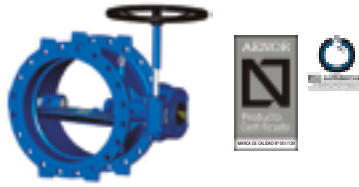

VÁLVULAS DE MARIPOSA MODELO DUPLEX 500

Serie 14 - PN10

Referencia	DN	€/Ud.
66615000012	150	1.436,90
666200010012	200	1.539,81
666250010012	250	1.766,47
666300010012	300	2.034,83
666350010012	350	2.710,94
666400010012	400	3.121,30
666450010012	450	4.474,81
666500010012	500	4.928,16
666600010012	600	6.225,65
666700010012	700	9.254,46
666800010012	800	12.847,35
666900010012	900	18.505,01
666100010012	1000	22.173,44
666110010012	1100	33.501,82

Serie 14 - PN16

Referencia	DN	€/Ud.
66615000012	150	1.436,90
666200016012	200	1.539,81
666250016012	250	1.766,47
666300016012	300	2.034,83
666350016012	350	2.710,94
666400016012	400	3.121,30
666450016012	450	4.474,81
666500016012	500	4.928,16
666600016012	600	7.469,76
666700016012	700	9.481,37
666800016012	800	13.231,64
666900016012	900	19.059,97
666100016012	1000	22.839,12
666110016012	1100	34.507,50

Con eje en acero inoxidable AISI 316 L +10%

Serie 14 - PN25

Referencia	DN	€/Ud.
666150025012	150	1.758,66
666200025012	200	1.883,73
666250025012	250	2.159,88
666300025012	300	2.488,18
666350025012	350	3.315,39
666400025012	400	3.816,95
666450025012	450	5.473,98
666500025012	500	6.027,64
666600025012	600	9.137,22
666700025012	700	15.524,41
666800025012	800	18.858,04
666900025012	900	23.769,27
666100025012	1000	31.069,65
666110025012	1100	Consultar



VÁLVULAS DE MARIPOSA MODELO DUPLEX 500 CON ASIENTO DE FUNDICIÓN

PN10

Referencia	DN	€/Ud.
10764175A	150	4.718,43
10764195A	200	4.821,34
10764215A	250	5.110,53
10764235A	300	5.378,90
10764255A	350	6.323,36
10764275A	400	7.318,63
10764295A	450	8.548,39
10764315A	500	9.806,82
10764335A	600	10.680,93
10764355A	700	13.486,96
10764375A	800	17.079,84
10764395A	900	22.585,09
10764415A	1000	26.253,53
10764435A	1100	40.240,74

PN16

Referencia	DN	€/Ud.
10764175A	150	4.718,43
10765205A	200	4.821,34
10765225A	250	5.110,53
10765245A	300	5.476,59
10765265A	350	6.908,27
10765285A	400	7.445,00
10765305A	450	9.323,50
10765325A	500	9.806,82
10765345A	600	12.087,89
10765365A	700	16.369,86
10765385A	800	19.895,00
10765405A	900	25.745,47
10765425A	1000	29.576,75
10765445A	1100	44.512,32

Con eje en acero inoxidable AISI 316 L CONSULTAR

PN25

Referencia	DN	€/Ud.
10769175A	150	5.040,19
10769195A	200	5.165,25
10769215A	250	5.602,95
10769235A	300	5.884,35
10769255A	350	7.640,38
10769275A	400	8.911,85
10769295A	450	9.547,57
10769315A	500	10.647,05
10769335A	600	13.296,77
10769355A	700	19.530,24
10769375A	800	25.264,77
10769395A	900	30.250,26
10769415A	1000	40.561,21
10769425A	1100	Consultar



VÁLVULAS DE MARIPOSA MODELO DUPLEX 316L CON ASIENTO DE ACERO INOXIDABLE 316L

Serie 14 - PN10

Referencia	DN	€/Ud.
10776010	150	1.965,79
10776020	200	2.106,48
10776030	250	2.415,23
10776040	300	2.782,60
10776050	350	3.708,82
10776060	400	4.268,99
10776070	450	5.866,11
10776080	500	6.460,15
10776100	600	8.161,48
10776120	700	12.132,15
10776140	800	16.841,44
10776160	900	24.260,39
10776180	1000	29.069,99
10776200	1100	43.920,90

Serie 14 - PN16

Referencia	DN	€/Ud.
10776010	150	1.965,79
10777020	200	2.106,48
10777030	250	2.415,23
10777040	300	2.782,60
10777050	350	3.708,82
10777060	400	4.268,99
10777070	450	5.866,11
10777080	500	6.460,15
10777100	600	9.792,48
10777120	700	12.495,60
10777140	800	17.346,90
10777160	900	24.988,60
10777180	1000	29.941,51
10777200	1100	45.239,25

Con eje en acero inoxidable AISI 316 L +10%

Serie 14 - PN25

Referencia	DN	€/Ud.
10778010	150	2.404,80
10778020	200	2.576,75
10778030	250	2.955,84
10778040	300	3.403,99
10778050	350	4.536,03
10778060	400	5.221,27
10778070	450	7.176,63
10778080	500	7.900,93
10778100	600	11.979,73
10778120	700	20.352,25
10778140	800	24.722,84
10778160	900	31.160,85
10778180	1000	40.733,17
10778200	1100	Consultar



VÁLVULAS DE MARIPOSA MODELO DUPLEX 316L CON REDUCTOR Y ACTUADOR ELÉCTRICO AUMA

PN10

Referencia	DN	€/Ud.
10783000A	150	5.247,32
10783005A	200	5.388,01
10783015A	250	5.759,28
10783025A	300	6.126,65
10783035A	350	7.321,23
10783045A	400	8.466,33
10783055A	450	9.939,68
10783065A	500	11.338,79
10783075A	600	12.616,75
10783085A	700	16.364,66
10783095A	800	21.073,95
10783105A	900	28.340,46
10783115A	1000	33.150,08
10783125A	1100	50.659,83

PN16

Referencia	DN	€/Ud.
10783000A	150	5.247,32
10783010A	200	5.388,01
10783020A	250	5.759,28
10783030A	300	6.224,35
10783040A	350	7.906,16
10783050A	400	8.592,67
10783060A	450	10.714,80
10783070A	500	11.338,79
10783080A	600	14.410,59
10783090A	700	19.333,53
10783100A	800	24.010,27
10783110A	900	31.674,11
10783120A	1000	36.679,12
10783130A	1100	55.244,06

Con eje en acero inoxidable AISI 316 L CONSULTAR

PN25

Referencia	DN	€/Ud.
10770175A	150	5.686,33
10770195A	200	5.858,29
10770215A	250	6.398,92
10770235A	300	6.800,16
10770255A	350	8.861,04
10770275A	400	10.316,16
10770295A	450	11.250,21
10770315A	500	12.520,35
10770335A	600	16.139,29
10770355A	700	24.358,08
10770375A	800	31.129,59
10770395A	900	37.641,82
10770415A	1000	50.224,71
10770425A	1100	Consultar



Opcional

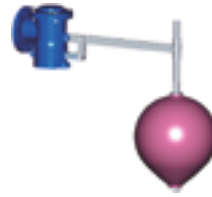

VÁLVULA DE MAREAS

PN16

Referencia	DN	€/Ud.
66608000013	80	278,45
66610000013	100	278,45
66615000013	150	278,45
66620000013	200	387,77
66625000013	250	542,30
66630000013	300	696,83
66635000013	350	905,29
66640000013	400	1.253,71
66645000013	450	1.656,06
66650000013	500	2.089,02
66660000013	600	2.915,59
66670000013	700	4.373,38
66680000013	800	5.831,18
66690000013	900	7.288,97
666100000113	1000	8.746,78
666120000013	1200	10.204,57

Opcional: Contrapeso +10 %



También disponible en color rojo para saneamiento y aguas residuales. **PRECIOS CONSULTAR**

VÁLVULA CON FLOTADOR

Referencia	DN	PN	€/Ud.
666040000015	40	10/16	954,86
666050000015	50	10/16	954,86
666060000015	60	10/16	1.093,35
666065000015	65	10/16	1.093,35
666080000015	80	10/16	1.151,66
666100000015	100	10/16	1.530,69
666125000015	125	10/16	2.624,03
666150000015	150	10/16	2.631,32
666200010015	200	10	4.373,38
666200016015	200	16	4.373,38
666250010015	250	10	5.831,18
666250016015	250	16	5.831,18

Flotador en acero inoxidable disponible bajo pedido



VÁLVULA MURAL

Referencia	DN	€/Ud.
66610000014	100	712,86
66615000014	150	1.462,18
66620000014	200	1.898,05
66625000014	250	2.116,72
66630000014	300	2.447,65
66635000014	350	2.683,81
66640000014	400	3.342,73
66645000014	450	4.185,33
66650000014	500	5.463,82
66660000014	600	6.796,25
66670000014	700	9.195,77
66680000014	800	11.083,62
66690000014	900	19.242,90
666100000114	1000	24.351,01
66612000014	1200	38.485,81

Con eje en acero inoxidable 316 L +20%

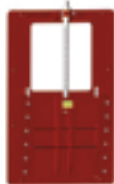

También disponible en color rojo para saneamiento y aguas residuales. **PRECIOS CONSULTAR**



FILTRO

PN16

Referencia	DN	€/Ud.
66604000032	40	190,98
66605000032	50	217,21
66606000032	60	294,47
66606500032	65	294,47
66608000032	80	319,26
66610000032	100	463,58
66612500032	125	571,46
66615000032	150	760,97
66620000032	200	1.269,73
66625000032	250	1.882,02
66630000032	300	2.524,90

También disponible en PN10 y PN25



VÁLVULA DE FONDO DE TANQUE

Referencia	DN	€/Ud.
66609000017	3"	180,77
66610000017	3 1/2"	242,00
66611000017	4"	291,56
66612500017	4 1/2"	364,46
66614000017	5"	510,22
66616000017	6"	801,79



VÁLVULAS DE RETENCIÓN DE CLAPETA
SERIE 48 - PN 16

Referencia	DN	€/Ud.
666050000028	50	279,16
666060000028	60	348,95
666065000028	65	348,95
666080000028	80	390,82
666100000028	100	474,56
666125000028	125	707,66
666150000028	150	1.046,82
666200000028	200	1.567,45
666250000028	250	2.791,53
666300000028	300	3.489,40
666350000028	350	4.187,28
666400000028	400	5.862,20
666450000028	450	8.374,57
666500000028	500	10.886,94
666600000028	600	15.772,10

Con eje y asiento en acero inoxidable AISI 316 L +30%



VÁLVULAS DE RETENCIÓN DE MARIPOSA
SERIE 14 - PN 16

Referencia	DN	€/Ud.
666150016029	150	2.247,91
666200016029	200	2.408,28
666250016029	250	2.762,52
666300016029	300	3.182,37
666350016029	350	4.240,72
666400016029	400	4.882,16
666450016029	450	7.000,32
666500016029	500	7.708,82
666600016029	600	11.685,70
666700016029	700	14.911,79
666800016029	800	20.700,69
666900016029	900	29.819,20
666100016029	1000	35.730,56

Con eje en acero inoxidable 316 L +15%



VÁLVULAS DE RETENCIÓN DE CLAPETA CON CONTRAPESO

SERIE 48 - PN 16

Referencia	DN	€/Ud.
666050016028	50	334,98
666060016028	60	418,73
666065016028	65	418,73
666080016028	80	474,56
666100016028	100	558,32
666125016028	125	837,45
666150016028	150	1.256,19
666200016028	200	1.884,28
666250016028	250	3.349,84
666300016028	300	4.187,28
666350016028	350	4.885,16
666400016028	400	6.978,81
666450016028	450	9.770,33
666500016028	500	11.863,97
666600016028	600	16.749,15

Con eje en acero inoxidable 316 L +30%

También disponible en color rojo para saneamiento y aguas residuales. **PRECIOS CONSULTAR**

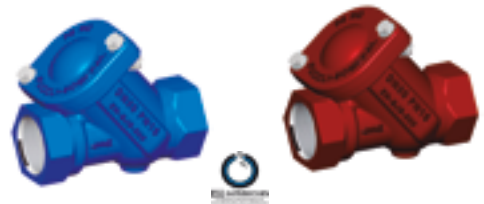

VÁLVULAS DE RETENCIÓN DE BOLA

PN 16

Referencia	Ø x Rh	€/Ud.
666032001630	32-1 ¼"	101,89
666040001630	40-1 ½"	101,89
666050001630	50-2"	122,83

Disponible también en PN10

También disponible en color rojo para saneamiento y aguas residuales. **PRECIOS CONSULTAR**

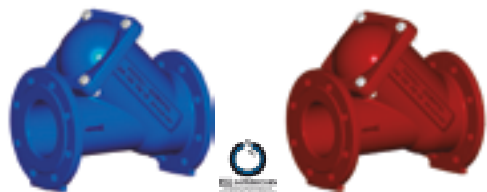

VÁLVULAS DE RETENCIÓN DE BOLA

PN 16

Referencia	DN	€/Ud.
666040016031	40	146,56
666050016031	50	146,56
666060016031	60	181,44
666065016031	65	181,44
666080016031	80	216,35
666100016031	100	307,08
666125016031	125	460,60
666150016031	150	572,27
666200016031	200	935,17
666250016031	250	2.009,90
666300016031	300	2.763,60
666350016031	350	4.326,87
666400016031	400	6.853,18

Disponible también en PN10

También disponible en color rojo para saneamiento y aguas residuales. **PRECIOS CONSULTAR**

HERRAMIENTA PARA EXTRACCIÓN DE BOLA

Referencia	DN	€/Ud.
10763744	32-1 ¼"	174,94
10763744	40-1 ½"	174,94
10763754	50-2"	174,94
10763744	40	174,94
10763754	50	174,94
10763764	60	291,56
10763764	65	291,56
10763784	80	291,56
10763794	100	335,30
10763804	125	335,30
10763814	150	379,03
10763824	200	451,90
10763834	250	553,96
10763844	300	728,89
10763854	350	1.020,46
10763864	400	1.312,02



BOLA DE RECAMBIO

Referencia	DN	€/Ud.
BOLA DE RECAMBIO DE ALUMINIO	32 / 1¼"	53,93
BOLA DE RECAMBIO DE ALUMINIO	40 / 1½"	53,93
BOLA DE RECAMBIO DE ALUMINIO	50 / 2"	53,93
BOLA DE RECAMBIO DE ALUMINIO	40	53,93
BOLA DE RECAMBIO DE ALUMINIO	50	53,93
BOLA DE RECAMBIO DE ALUMINIO	60	58,32
BOLA DE RECAMBIO DE ALUMINIO	65	58,32
BOLA DE RECAMBIO DE ALUMINIO	80	68,52
BOLA DE RECAMBIO DE ALUMINIO	100	103,51
BOLA DE RECAMBIO DE HIERRO	125	147,24
BOLA DE RECAMBIO DE HIERRO	150	176,39
BOLA DE RECAMBIO DE HIERRO	200	322,16
BOLA DE RECAMBIO DE HIERRO	250	648,72
BOLA DE RECAMBIO DE HIERRO	300	944,64
BOLA DE RECAMBIO DE HIERRO	350	1.316,39
BOLA DE RECAMBIO DE HIERRO	400	2.339,77



VENTOSAS AUTOMÁTICAS DE DOBLE EFECTO

PN 16

Referencia	DN	€/Ud.
666040065011	40-50-60-65	263,87
666080002111	80	311,96
666100002111	100	311,96
666025002111	1"	228,87
666032002111	1 ¼"	228,87

Referencia	DN	€/Ud.
666040000111	1 ½"	228,87
666200002111	2"	228,87
666212002111	2 ½"	240,54

Opcional con filtro. Consultar.



VENTOSAS AUTOMÁTICAS DE TRIPLE EFECTO SIN VÁLVULA PARA AGUAS LIMPIAS

PN 10

Referencia	DN	€/Ud.
19908610	50	593,32
19908615	60	593,32
19908620	65	593,32
19908630	80	698,28
19908640	100	698,28
19908650	150	1.788,71
19908660	200	2.867,49

PN 16

Referencia	DN	€/Ud.
19908610	50	593,32
19908615	60	593,32
19908620	65	593,32
19908630	80	698,28
19908640	100	698,28
19908650	150	1.788,71
19908661	200	2.867,49

PN 25

Referencia	DN	€/Ud.
19908665	50	715,78
19908670	60	715,78
19908680	65	715,78
19908690	80	848,43
19908695	100	848,43
19908700	150	2.124,01
19908705	200	3.409,79



VENTOSAS AUTOMÁTICAS DE TRIPLE EFECTO CON VÁLVULA PARA AGUAS LIMPIAS

PN 10

Referencia	DN	€/Ud.
666050003005	50	817,83
666060003005	60	817,83
666065003005	65	817,83
666080003005	80	998,59
666100003005	100	998,59
666150003005	150	2.239,17
666200013005	200	3.618,25

PN 16

Referencia	DN	€/Ud.
666050003005	50	817,83
666060003005	60	817,83
666065003005	65	817,83
666080003005	80	998,59
666100003005	100	998,59
666150003005	150	2.239,17
666200003005	200	3.618,25

PN 25

Referencia	DN	€/Ud.
666050003025	50	940,28
666060003025	60	940,28
666065003025	65	940,28
666080003025	80	1.148,75
666100003025	100	1.148,75
666150003025	150	2.574,46
666200003025	200	4.160,56



HIDRANTE DE SUPERFICIE COLUMNA SECA

Referencia	DN	PN	€/Ud.
666045070036	100	2x45-1x70	1.395,76
666070100036	100	2x70-1x100	1.395,76



HIDRANTE DE SUPERFICIE COLUMNA SECA
"CLASSIC"

Referencia	DN	PN	€/Ud.
666045070037	100	2x45-1x70	1.676,47
666070100037	100	2x70-1x100	1.676,47



KIT DE SUSTITUCIÓN Y LLAVE

Referencia	DN	€/Ud.
11212000	KIT	109,34
11209065	LLAVE	68,52



S DE AJUSTE EN ALTURA CON BRIDA MÓVIL
PN 10 / 16

Referencia	DN	€/Ud.
10005059	80	240,54
10005060	100	269,70
10005065	150	364,46





CODO EMBRIDADO-ENCHUFE CON PEANA PARA HIDRANTES

Referencia	Descripción	€/Ud.
666080090036	CODO 90° BRIDA / ENCHUFE PVC 80 X 90 CON PIE	96,47
666100090036	CODO 90° BRIDA / ENCHUFE PVC 100 X 90 CON PIE	115,69
666100110036	CODO 90° BRIDA / ENCHUFE PVC 100 X 110 CON PIE	115,69
666125140036	CODO 90° BRIDA / ENCHUFE PVC 125 X 140 CON PIE	125,31
666150160036	CODO 90° BRIDA / ENCHUFE PVC 150 X 160 CON PIE	164,39

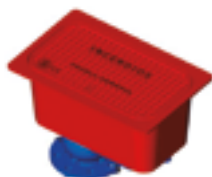

HIDRANTES DE ACERA

Referencia	DN	Salidas DN	Con Arqueta	€/Ud.
666080070034	80	BARNA 70	SI	527,29
666080070035	80	BARNA 70	NO	397,02
666100100034	100	100	SI	635,85
666100100035	100	100	NO	505,58



BOCA DE RIEGO

Referencia	DN	Salidas DN	€/Ud.
666040065014	40-50-60-65	Rosca 1 1/2" Racord Barcelona	347,39



COLLARÍN DE TOMA PARA PVC Y PE
PN10 - PN16 - PN25

Referencia	Ø x Rh	€/Ud.
666050034004	50 ¾"	24,81
666050100004	50 1"	24,81
666050114004	50 1 ¼"	24,81
666050112004	50 1 ½"	24,81
666063034004	63 ¾"	27,30
666063100004	63 1"	27,30
666063114004	63 1 ¼"	27,30
666063112004	63 1 ½"	27,30
666063200004	63 2"	27,30
666075034004	75 ¾"	31,01
666075100004	75 1"	31,01
666075114004	75 1 ¼"	31,01
666075112004	75 1 ½"	31,01
666075200004	75 2"	31,01
666090034004	90 ¾"	35,97
666090100004	90 1"	35,97
666090114004	90 1 ¼"	35,97
666090112004	90 1 ½"	35,97
666090200004	90 2"	35,97
666090212004	90 2 ½"	43,43
666110034004	110 ¾"	43,43
666110100004	110 1"	43,43
666110114004	110 1 ¼"	43,43
666110112004	110 1 ½"	43,43
666110200004	110 2"	43,43
666110212004	110 2 ½"	52,12
666110300004	110 3"	55,83
666125034004	125 ¾"	67,00
666125100004	125 1"	67,00
666125114004	125 1 ¼"	67,00
666125112004	125 1 ½"	67,00
666125200004	125 2"	67,00
666125212004	125 2 ½"	80,64
666125300004	125 3"	86,85
666140034004	140 ¾"	67,00
666140100004	140 1"	67,00
666140114004	140 1 ¼"	67,00
666140112004	140 1 ½"	67,00
666140200004	140 2"	67,00
666140212004	140 2 ½"	80,64
666140300004	140 3"	86,85
666160034004	160 ¾"	69,48
666160100004	160 1"	69,48

Referencia	Ø x Rh	€/Ud.
666160114004	160 1 ¼"	69,48
666160112004	160 1 ½"	69,48
666160200004	160 2"	69,48
666160212004	160 2 ½"	81,90
666160300004	160 3"	89,33
666180034004	180 ¾"	99,25
666180100004	180 1"	99,25
666180114004	180 1 ¼"	99,25
666180112004	180 1 ½"	99,25
666180200004	180 2"	99,25
666200034004	200 ¾"	99,25
666200100004	200 1"	99,25
666200114004	200 1 ¼"	99,25
666200112004	200 1 ½"	99,25
666200200004	200 2"	99,25
666200212004	200 2 ½"	124,07
666200300004	200 3"	134,00
666225034004	225 ¾"	124,04
666225100004	225 1"	124,04
666225114004	225 1 ¼"	124,04
666225112004	225 1 ½"	124,04
666225200004	225 2"	124,04
666225212004	225 2 ½"	148,05
666225300004	225 3"	148,05
666250034004	250 ¾"	124,04
666250100004	250 1"	124,04
666250114004	250 1 ¼"	124,04
666250112004	250 1 ½"	124,04
666250200004	250 2"	124,04
666250212004	250 2 ½"	161,37
666250300004	250 3"	161,37
666280034004	280 ¾"	144,04
666280100004	280 1"	144,04
666280114004	280 1 ¼"	144,04
666280112004	280 1 ½"	144,04
666280200004	280 2"	144,04
666280212004	280 2 ½"	170,72
666280300004	280 3"	170,72
666315034004	315 ¾"	148,05
666315100004	315 1"	148,05
666315114004	315 1 ¼"	148,05
666315112004	315 1 ½"	148,05
666315200004	315 2"	148,05
666315212004	315 2 ½"	148,05
666315300004	315 3"	176,05
666400034004	400 ¾"	180,05
666400100004	400 1"	180,05
666400114004	400 1 ¼"	180,05
666400112004	400 1 ½"	180,05
666400200004	400 2"	180,05
666400212004	400 2 ½"	213,40
666400300004	400 3"	229,39

COLLARÍN CON SALIDA BRIDA



Referencia	DN	DN EXT.TUBO (MÍN-MÁX)	DN BRIDA	€/Ud.
10485110	60	68/78	40-65	158,91
10485120	80	87/99	40-65	158,91
10485130	100	104/119	40-65	164,73
10485150	150	150/175	40-65	215,75
10485160	200	213/228	40-65	268,23
10485170	250	274	40-65	275,52
10485180	300	326	40-65	323,63



ABRAZADERA ROSCADA (HASTA 1½ ") PARA FIBROCEMENTO/FUNDICIÓN

Referencia	Ø x Rh	€/Ud.
666050111005	50 ½"	20,40
666050034005	50 ¾"	20,40
666050100005	50 1"	20,40
666050114005	50 1 ¼"	20,40
666050112005	50 1 ½"	20,40
666060111005	60 ½"	21,87
666060034005	60 ¾"	21,87
666060100005	60 1"	21,87
666060114005	60 1 ¼"	21,87
666060112005	60 1 ½"	21,87
666080111005	80 ½"	26,13
666080034005	80 ¾"	26,13
666080100005	80 1"	26,13
666080114005	80 1 ¼"	26,13
666080112005	80 1 ½"	26,13
666100111005	100 ½"	37,90
666100034005	100 ¾"	37,90
666100100005	100 1"	37,90
666100114005	100 1 ¼"	37,90
666100112005	100 1 ½"	37,90
666125111005	125 ½"	48,10
666125034005	125 ¾"	48,10
666125100005	125 1"	48,10
666125114005	125 1 ¼"	48,10
666125112005	125 1 ½"	48,10
666150111005	150 ½"	58,32
666150034005	150 ¾"	58,32
666150100005	150 1"	58,32
666150114005	150 1 ¼"	58,32
666150112005	150 1 ½"	58,32
666200111005	200 ½"	90,39
666200034005	200 ¾"	90,39
666200100005	200 1"	90,39
666200114005	200 1 ¼"	90,39
666200112005	200 1 ½"	90,39
666250111005	250 ½"	104,97
666250034005	250 ¾"	104,97
666250100005	250 1"	104,97

Referencia	Ø x Rh	€/Ud.
666250114005	250 1 ¼"	104,97
666250112005	250 1 ½"	104,97
666300111005	300 ½"	145,78
666300034005	300 ¾"	145,78
666300100005	300 1"	145,78
666300114005	300 1 ¼"	145,78
666300112005	300 1 ½"	249,29
666350111005	350 ½"	249,29
666350034005	350 ¾"	249,29
666350100005	350 1"	249,29
666350114005	350 1 ¼"	249,29
666350112005	350 1 ½"	502,93
666400111005	400 ½"	502,93
666400034005	400 ¾"	502,93
666400100005	400 1"	502,93
666400114005	400 1 ¼"	502,93
666400112005	400 1 ½"	685,17
666450111005	450 ½"	685,17
666450034005	450 ¾"	685,17
666450100005	450 1"	685,17
666450114005	450 1 ¼"	685,17
666450112005	450 1 ½"	790,13
666500111005	500 ½"	790,13
666500034005	500 ¾"	790,13
666500100005	500 1"	790,13
666500114005	500 1 ¼"	790,13
666500112005	500 1 ½"	790,13
666600111005	600 ½"	1.250,79
666600034005	600 ¾"	1.250,79
666600100005	600 1"	1.250,79
666600114005	600 1 ¼"	1.250,79
666600112005	600 1 ½"	1.250,79
666700111005	700 ½"	1.832,46
666700034005	700 ¾"	1.832,46
666700100005	700 1"	1.832,46
666700114005	700 1 ¼"	1.832,46
666700112005	700 1 ½"	1.832,46

Rosca de 2" +20% - Rosca de 2 ½" y 3" +30% -
Rosca de 4" +50%



ADAPTADOR DE TOMA EN CARGA

PN 10 - PN 16

Referencia	Rm x Rh	€/Ud.
666212000000	2" 1/2"	145,78
666234000000	2" 3/4"	145,78
666210000000	2" 1"	145,78
666211400000	2" 1 1/4"	145,78
666211200000	2" 1 1/2"	145,78
666220000000	2" 2"	145,78



LAMINA DE CORTE

Referencia	€/Ud.
666LAM000000	72,89



BRIDAS DE UNIÓN DE DOBLE CÁMARA PARA TUBO DE PVC

Referencia	DN/DN Tubo	PN	€/Ud.
666063000000	50-63	10/16	25,13
666050065000	50-60-65/63	10/16	25,13
666065000000	60-65/63	10/16	25,13
666075000000	60-65/75	10/16	26,51
666090000000	80/90	10/16	32,10
666100000000	100/90	10/16	36,30
666110000000	100/110	10/16	36,30
666125000000	125/125	10/16	43,28
666140000000	125/140	10/16	47,44
666160000000	150/160	10/16	65,60
666200000000	200/200	10/16	78,16
666225000000	200/225	10/16	163,32
666250000000	250/250	10/16	146,56
666280000000	250/280	10/16	267,99
666315000000	300/315	10/16	267,99
666400010000	400/400	10	537,36
666400000000	400/400	16	537,36
666500010000	500/500	10	830,48
666500000000	500/500	16	830,48

También disponible en color rojo para saneamiento y aguas residuales. **PRECIOS CONSULTAR**



BRIDAS DE UNIÓN DE DOBLE CÁMARA PARA FUNDICIÓN DÚCTIL

Referencia	DN/DN Tubo	PN	€/Ud.
666050000006	50/66	10/16	41,88
666065000006	60-65/77	10/16	41,88
666070000006	65/82	10/16	41,88
666080000006	80/98	10/16	55,83
666100000006	100/118	10/16	64,21
666125000006	125/144	10/16	83,74
666150000006	150/170	10/16	97,70
666200000006	200/222	10/16	139,57
666250000006	250/274	10/16	209,37
666300000006	300/326	10/16	307,08
666350000006	350/378	10/16	697,87
666400010006	400/429	10	767,66
666400000006	400/429	16	767,66
666450010006	450/480	10	921,20
666450000006	450/480	16	921,20
666500010006	500/532	10	977,03
666500000006	500/532	16	977,03
666600010006	600/635	10	1.535,34
666600000006	600/635	16	1.535,34

También disponible en color rojo para saneamiento y aguas residuales. **PRECIOS CONSULTAR**



También disponible en color rojo para saneamiento y aguas residuales. **PRECIOS CONSULTAR**

BRIDAS DE UNIÓN DE DOBLE CÁMARA CON ANILLO AUTOBLOCANTE PARA PVC Y PE

Referencia	DN/DN Tubo	PN	€/Ud.
666063000003	50/63	10/16	41,88
666065000003	60-65/63	10/16	46,06
666075000003	60-65/75	10/16	50,24
666090000003	80/90	10/16	57,23
666100000003	100/90	10/16	62,81
666110000003	100/110	10/16	62,81
666125000003	125/125	10/16	87,94
666140000003	125/140	10/16	92,11
666160000003	150/160	10/16	117,24
666200000003	200/200	10/16	150,75
666225000003	200/225	10/16	390,82
666250000003	250/250	10/16	343,35
666280000003	250/280	10/16	642,06
666315000003	300/315	10/16	478,74
666400010003	400/400	10	930,97
666400000003	400/400	16	930,97
666500010003	500/500	10	1.429,26
666500000003	500/500	16	1.429,26

Referencia	DN/DN Tubo	PN	€/Ud.
666063025003	50/63	25	51,65
666065025003	60-65/63	25	57,23
666075025003	60-65/75	25	64,21
666090025003	80/90	25	71,18
666100025003	100/90	25	79,55
666110025003	100/110	25	79,55
666125025003	125/125	25	107,47
666140025003	125/140	25	115,84
666160025003	150/160	25	146,56
666200025003	200/200	25	188,43
666225025003	200/225	25	491,31
666250025003	250/250	25	431,30
666280025003	250/280	25	Consultar
666315025003	300/315	25	601,57
666400025003	400/400	25	1.217,11
666500025003	500/500	25	1.857,76



* ACS sólo para accesorios azules



También disponible en color rojo para saneamiento y aguas residuales. **PRECIOS CONSULTAR**

UNIONES DE BOCAS SIMPLES

PN 10 - PN 16 - PN 25

Referencia	Ø	€/Ud.
666063000033	63	37,23
666075000033	75	38,46
666090000033	90	44,67
666110000033	110	60,78
666125000033	125	75,68
666140000033	140	86,85
666160000033	160	121,59

Referencia	Ø	€/Ud.
666200000033	200	173,69
666225000033	225	Consultar
666250000033	250	293,11
666280000033	280	Consultar
666315000033	315	572,27
666400000033	400	837,45



* ACS sólo para accesorios azules



También disponible en color rojo para saneamiento y aguas residuales. **PRECIOS CONSULTAR**

REDUCCIONES

PN 10 - PN 16 - PN 25

Referencia	Ø	€/Ud.
666075063019	75 x 63	31,01
666090063019	90 x 63	37,23
666090075019	90 x 75	39,70
666110063019	110 x 63	43,43
666110075019	110 x 75	48,38
666110090019	110 x 90	48,38
666125063019	125 x 63	55,83
666125075019	125 x 75	55,83
666125090019	125 x 90	55,83
666125110019	125 x 110	62,04
666140063019	140 x 63	68,23
666140075019	140 x 75	68,23
666140090019	140 x 90	68,23
666140110019	140 x 110	74,44
666140125019	140 x 125	74,44
666160063019	160 x 63	80,64
666160075019	160 x 75	80,64
666160090019	160 x 90	80,64
666160110019	160 x 110	80,64
666160125019	160 x 125	80,64
666160140019	160 x 140	86,85
666180140019	180 x 140	310,17
666180160019	180 x 160	310,17
666200063019	200 x 63	111,67

Referencia	Ø	€/Ud.
666200075019	200 x 75	111,67
666200090019	200 x 90	111,67
666200110019	200 x 110	111,67
666200125019	200 x 125	111,67
666200140019	200 x 140	124,07
666200160019	200 x 160	124,07
666200180019	200 x 180	310,17
666225110019	225 x 110	390,82
666225160019	225 x 160	390,82
666250075019	250 x 75	348,95
666250090019	250 x 90	348,95
666250110019	250 x 110	348,95
666250125019	250 x 125	348,95
666250140019	250 x 140	348,95
666250160019	250 x 160	348,95
666250180019	250 x 180	348,95
666250200019	250 x 200	348,95
666315110019	315 x 110	558,32
666315160019	315 x 160	558,32
666315200019	315 x 200	558,32
666315225019	315 x 225	637,86
666315250019	315 x 250	558,32
666400140019	400 x 140	925,39
666400200019	400 x 200	925,39
666400315019	400 x 315	925,39



*ACS sólo para accesorios azules

CODOS 90°

PN 10 - PN 16 - PN 25

Referencia	Ø	€/Ud.
666063090016	63	32,26
666075090016	75	39,70
666090090016	90	43,43
666110090016	110	58,32
666125090016	125	76,93
666140090016	140	90,56
666160090016	160	121,59
666180090016	180	279,16
666200090016	200	182,38
666225090016	225	341,97
666250090016	250	341,97
666280090016	280	Consultar
666315090016	315	664,38
666400090016	400	1.312,02

También disponible en color rojo para saneamiento y aguas residuales. **PRECIOS CONSULTAR**



*ACS sólo para accesorios azules

CODOS 45°

PN 10 - PN 16 - PN 25

Referencia	Ø	€/Ud.
666063045016	63	29,78
666075045016	75	32,26
666090045016	90	40,94
666110045016	110	54,58
666125045016	125	68,23
666140045016	140	86,85
666160045016	160	105,45
666180045016	180	254,34
666200045016	200	142,68
666225045016	225	321,02
666250045016	250	300,09
666280045016	280	Consultar
666315045016	315	626,69
666400045016	400	1.045,43

También disponible en color rojo para saneamiento y aguas residuales. **PRECIOS CONSULTAR**



*ACS sólo para accesorios azules

CODOS 22° 30'

PN 10 - PN 16 - PN 25

Referencia	Ø	€/Ud.
666063223016	63	29,78
666075223016	75	32,26
666090223016	90	40,94
666110223016	110	49,63
666125223016	125	58,32
666140223016	140	68,23
666160223016	160	89,33
666200223016	200	130,28
666225223016	225	286,12
666250223016	250	254,03
666280223016	280	Consultar
666315223016	315	418,73
666400223016	400	914,22

También disponible en color rojo para saneamiento y aguas residuales. **PRECIOS CONSULTAR**



*ACS sólo para accesorios azules

CODOS 11° 15'

PN 10 - PN 16 - PN 25

Referencia	Ø	€/Ud.
666063111016	63	29,78
666075111016	75	32,26
666090111016	90	40,94
666110111016	110	49,63
666125111016	125	58,32
666140111016	140	68,23
666160111016	160	89,33
666200111016	200	130,28
666225111016	225	286,12
666250111016	250	254,03
666280111016	280	Consultar
666315111016	315	418,73
666400111016	400	914,22

También disponible en color rojo para saneamiento y aguas residuales. **PRECIOS CONSULTAR**



* ACS sólo para accesorios azules



TÉS EMBRIDADAS PARA PVC

PN 10 - PN 16

Referencia	Ø x DN	€/Ud.
666063050022	63 x 50	55,83
666063060022	63 x 60	55,83
666063065022	63 x 65	55,83
666075050022	75 x 50	74,44
666075060022	75 x 60	74,44
666075065022	75 x 65	74,44
666090050022	90 x 50	86,85
666090060022	90 x 60	86,85
666090065022	90 x 65	86,85
666090080022	90 x 80	86,85
666110050022	110 x 50	102,98
666110060022	110 x 60	102,98
666110065022	110 x 65	102,98
666110080022	110 x 80	102,98
666110100022	110 x 100	102,98
666125050022	125 x 50	136,48
666125060022	125 x 60	136,48
666125065022	125 x 65	136,48
666125080022	125 x 80	165,01
666125100022	125 x 100	165,01
666125125022	125 x 125	165,01
666140050022	140 x 50	173,69
666140060022	140 x 60	173,69
666140065022	140 x 65	173,69
666140080022	140 x 80	173,69
666140100022	140 x 100	173,69
666140125022	140 x 125	173,69
666160050022	160 x 50	186,11
666160060022	160 x 60	186,11
666160065022	160 x 65	186,11
666160080022	160 x 80	186,11
666160100022	160 x 100	186,11
666160125022	160 x 125	186,11
666160150022	160 x 150	186,11
666180050022	180 x 50	Consultar
666180080022	180 x 80	310,17
666180100022	180 x 100	Consultar
666180150022	180 x 150	310,17
666200050022	200 x 50	248,14
666200060022	200 x 60	248,14
666200065022	200 x 65	248,14
666200080022	200 x 80	297,77

Referencia	Ø x DN	€/Ud.
666200100022	200 x 100	297,77
666200125022	200 x 125	297,77
666200150022	200 x 150	297,77
666200200022	200 x 200	297,77
666225060022	225 x 60	369,88
666225080022	225 x 80	369,88
666225100022	225 x 100	369,88
666225150022	225 x 150	369,88
666225200022	225 x 200	530,39
666250050022	250 x 50	474,56
666250060022	250 x 60	474,56
666250065022	250 x 65	474,56
666250080022	250 x 80	474,56
666250100022	250 x 100	474,56
666250125022	250 x 125	474,56
666250150022	250 x 150	474,56
666250200022	250 x 200	488,53
666250250022	250 x 250*	516,43
666280060022	280 x 60	935,17
666280080022	280 x 80	935,17
666315050022	315 x 50	988,20
666315060022	315 x 60	988,20
666315065022	315 x 65	988,20
666315080022	315 x 80	988,20
666315100022	315 x 100	988,20
666315125022	315 x 125	988,20
666315150022	315 x 150	988,20
666315200022	315 x 200	1.102,66
666315250022	315 x 250*	1.187,78
666315300022	315 x 300*	1.187,78
666400050022	400 x 50	2.293,23
666400060022	400 x 60	2.293,23
666400080022	400 x 80	2.293,23
666400100022	400 x 100	2.293,23
666400125022	400 x 125	2.293,23
666400150022	400 x 150	2.293,23
666400200022	400 x 200	2.293,23
666400250022	400 x 250*	2.293,23
666400300022	400 x 300*	2.293,23
666400400022	400 x 400*	2.293,23

También disponible en color rojo para saneamiento y aguas residuales. **PRECIOS CONSULTAR**



* ACS sólo para accesorios azules



TÉS IGUALES Y REDUCIDAS

PN 10 - PN 16 - PN 25

Referencia	Ø	€/Ud.
666063063020	63 x 63	49,63
666075063020	75 x 63	52,12
666075075020	75 x 75	52,12
666090063020	90 x 63	58,32
666090075020	90 x 75	58,32
666090090020	90 x 90	58,32
666110063020	110 x 63	79,40
666110075020	110 x 75	79,40
666110090020	110 x 90	79,40
666110110020	110 x 110	79,40
666125063020	125 x 63	98,01
666125075020	125 x 75	98,01
666125090020	125 x 90	98,01
666125110020	125 x 110	98,01
666125125020	125 x 125	98,01
666140063020	140 x 63	126,55
666140075020	140 x 75	126,55
666140090020	140 x 90	126,55
666140110020	140 x 110	126,55
666140125020	140 x 125	126,55
666140140020	140 x 140	126,55
666160063020	160 x 63	148,88
666160075020	160 x 75	148,88
666160090020	160 x 90	148,88
666160110020	160 x 110	148,88
666160125020	160 x 125	148,88
666160140020	160 x 140	148,88
666160160020	160 x 160	148,88
666180180020	180 x 180	575,67
666200063020	200 x 63	291,56
666200075020	200 x 75	291,56

Referencia	Ø	€/Ud.
666200090020	200 x 90	291,56
666200110020	200 x 110	291,56
666200125020	200 x 125	291,56
666200140020	200 x 140	291,56
666200160020	200 x 160	291,56
666200180020	200 x 180	291,56
666200200020	200 x 200	291,56
666250063020	250 x 63	656,01
666250075020	250 x 75	656,01
666250090020	250 x 90	656,01
666250110020	250 x 110	656,01
666250125020	250 x 125	656,01
666250140020	250 x 140	656,01
666250160020	250 x 160	656,01
666250200020	250 x 200	656,01
666250250020	250 x 250	656,01
666315063020	315 x 63	963,08
666315075020	315 x 75	963,08
666315090020	315 x 90	963,08
666315110020	315 x 110	963,08
666315125020	315 x 125	963,08
666315140020	315 x 140	963,08
666315160020	315 x 160	963,08
666315200020	315 x 200	963,08
666315250020	315 x 250	963,08
666315315020	315 x 315	963,08
666400110020	400 x 110	1.954,07
666400140020	400 x 140	1.954,07
666400250020	400 x 250	1.954,07
666400315020	400 x 315	1.954,07
666400400020	400 x 400	1.954,07

También disponible en color rojo para saneamiento y aguas residuales. **PRECIOS CONSULTAR**



* ACS sólo para accesorios azules

TÉS PARA PVC CON DERIVACIÓN ROSCADA

PN 10 - PN 16 - PN 25

Referencia	Ø x Rh	€/Ud.
666063112021	63- 1 ½"	49,63
666063200021	63-2"	49,63
666075112021	75- 1 ½"	68,23
666075200021	75-2"	68,23
666090112021	90- 1 ½"	86,85
666090200021	90-2"	86,85
666090212021	90-2 ½"	86,85
666110112021	110- 1 ½"	99,25
666110200021	110-2"	99,25
666110212021	110-2 ½"	99,25
666125112021	125-½"	105,45
666125200021	125-2"	105,45
666140112021	140- 1 ½"	114,13
666140200021	140-2"	114,13
666160112021	160- 1 ½"	167,49
666160200021	160-2"	167,49
666200112021	200- 1 ½"	263,02
666200200021	200-2"	263,02
666250112021	250- 1 ½"	484,33
666250200021	250-2"	484,33
666315112021	315- 1 ½"	837,45
666315200021	315-2"	837,45
666400112021	400- 1 ½"	1.395,76
666400200021	400-2"	1.395,76

También disponible en color rojo para saneamiento y aguas residuales. **PRECIOS CONSULTAR**



* ACS sólo para accesorios azules

CRUCETAS

PN 10 - PN 16 - PN 25

Referencia	Ø	€/Ud.
666063000018	63 x 63	78,16
666075000018	75 x 75	86,85
666090000018	90 x 90	161,29
666110000018	110 x 110	167,49
666125000018	125 x 125	232,01
666140000018	140 x 140	349,88
666160090018	160 x 90	385,86
666160110018	160 x 110	385,86
666160000018	160 x 160	385,86
666200090018	200 x 90	508,68
666200110018	200 x 110	508,68
666200000018	200 x 200	508,68
666250200018	250 x 200	1.162,66
666250000018	250 x 250	1.162,66
666315000018	315 x 315	1.884,28
666400000018	400 x 400	4.424,55

También disponible en color rojo para saneamiento y aguas residuales. **PRECIOS CONSULTAR**



CODOS 90° AUTOBLOCANTES PARA TUBOS DE PE Y PVC BLOCKPLUS

PN 16

Referencia	Ø	€/Ud.
10418000	63	145,78
10418005	75	153,07
10418010	90	167,64
10418014	110	189,51
10418020	125	262,40
10418030	160	408,19
10418035	200	758,05



CODOS 45° AUTOBLOCANTES PARA TUBOS DE PE Y PVC BLOCKPLUS

PN 16

Referencia	Ø	€/Ud.
10418100	63	145,78
10418105	75	153,07
10418110	90	167,64
10418115	110	189,51
10418120	125	262,40
10418730	160	466,49
10418135	200	685,17



TES AUTOBLOCANTES PARA TUBOS DE PE Y PVC BLOCKPLUS

PN 16

Referencia	Ø	€/Ud.
10418100	63	145,78
10418105	75	153,07
10418110	90	167,64
10418115	110	189,51
10418120	125	262,40
10418730	160	364,46
10418135	200	685,17



ADAPTADOR ROSCA MACHO-HEMBRA PARA TUBO DE PE

Referencia	Ø x Rm	€/Ud.
10480550	25-¾"	13,12
10480555	32-1"	18,95
10480560	40-1 ¼"	26,24
10480565	50-1 ½"	36,44
10480570	63-2"	52,48



ADAPTADOR ROSCA HEMBRA-HEMBRA PARA TUBO DE PE

Referencia	Ø x Rh	€/Ud.
10480500	25-¾"	17,50
10480505	32-1"	23,33
10480510	40-1 ¼"	Consultar
10480515	50-1 ½"	39,36
10480520	63-2"	62,69



UNIÓN DOS BOCAS PARA TUBO DE PE

Referencia	Ø	€/Ud.
10480400	25	17,50
10480405	32	26,24
10480410	40	36,44
10480415	50	48,10
10480420	63	75,81



CODO 90° ROSCA HEMBRA-HEMERA PARA TUBO DE PE

Referencia	Ø x Rh	€/Ud.
10001800	25-¾"	18,95
10001805	32-1"	26,24
10001810	40-1 ¼"	39,36
10001815	50-1 ½"	56,85
10001820	63-2"	75,81



CODO 90° ROSCA MACHO-HEMERA PARA TUBO DE PE

Referencia	Ø x Rm	€/Ud.
10001900	25-¾"	18,95
10001905	32-1"	26,24
10001910	40-1 ¼"	Consultar
10001915	50-1 ½"	56,85
10001920	63-2"	75,81



CODO 45° MACHO-HEMERA PARA TUBO DE PE

Referencia	Ø x Rm	€/Ud.
10001960	25	26,09
10001980	63	133,02



CODO 90° HEMBRA-HEMERA PARA TUBO DE PE

Referencia	Ø	€/Ud.
10001850	25	17,50
10001855	32	30,63
10001860	40	Consultar
10001865	50	68,52
10001870	63	94,76



ESPÁTULAS DE EXTRACCIÓN DE PE

Referencia	Ø	€/Ud.
666ESP000025	25	301,76
666ESP000032	32	301,76
666ESP000040	40	301,76
666ESP000050	50	335,30
666ESP000063	63	408,19



* ACS sólo para accesorios azules



* ACS sólo para accesorios azules

CODOS 90° EMBRIDADOS EN FUNDICIÓN DÚCTIL CON BRIDA MÓVIL

PN 10 - PN 16

Referencia	DN	€/Ud.
666040000018	40	59,93
666050000018	50	59,93
666060000018	60	63,84
666065000018	65	63,84
666080000018	80	72,95
666100000018	100	92,50
666125000018	125	232,01
666150000018	150	165,43
666200000018	200	229,27
666250000018	250*	489,91
666300000018	300*	752,32
666350000018	350*	1.688,87
666400000018	400*	2.533,30
666450000018	450*	2.871,08
666500000018	500*	3.377,73
666600000018	600*	7.768,82
666700000018	700**	8.613,25
666800000018	800**	11.990,98
666900000018	900**	14.584,31
666101000018	1000**	17.163,67

* Las referencias hasta DN 200, incluida, son PN10/16. Para DN 250 a DN 1000 indicar que taladro se requiere.

** Con brida fija.

CODOS 45° EMBRIDADOS EN FUNDICIÓN DÚCTIL CON BRIDA MÓVIL

PN 10 - PN 16

Referencia	DN	€/Ud.
666040045018	40	59,93
666050045018	50	59,93
666060045018	60	63,84
666065045018	65	63,84
666080045018	80	72,95
666100045018	100	92,50
666125045018	125	110,73
666150045018	150	165,43
666200045018	200	229,27
666250045018	250*	470,37
666300045018	300*	844,43
666350045018	350*	1.217,11
666400045018	400*	1.351,10
666450045018	450*	2.162,03
666500045018	500*	2.533,30
666600045018	600*	3.238,17
666700045018	700**	6.755,49
666800045018	800**	9.206,45
666900045018	900**	10.881,36
666001045018	1000**	12.596,74

También disponibles en PN25

* Las referencias hasta DN 200, incluida, son PN10/16. Para DN 250 a DN 1000 indicar que taladro se requiere.

** Con brida fija.



También disponible en color rojo para saneamiento y aguas residuales. **PRECIOS CONSULTAR**



También disponible en color rojo para saneamiento y aguas residuales. **PRECIOS CONSULTAR**



* ACS sólo para accesorios azules



* ACS sólo para accesorios azules

CODOS 22° 30' EMBRIDADOS EN FUNDICIÓN DÚCTIL CON BRIDA MÓVIL

PN 10 - PN 16

Referencia	DN	€/Ud.
666050223018	50	54,70
666060223018	60	59,93
666065223018	65	59,93
666080223018	80	69,04
666100223018	100	83,37
666125223018	125	95,09
666150223018	150	128,97
666200223018	200	183,68
666250223018	250*	392,20
666300223018	300*	562,49
666350223018	350*	1.013,33
666400223018	400*	1.182,20
666450223018	450*	1.688,87
666500223018	500*	1.790,76
666600223018	600*	3.213,04
666700223018	700**	6.079,94
666800223018	800**	8.458,31
666900223018	900**	10.067,63
666001223018	1000**	11.805,35

También disponibles en PN25

* Las referencias hasta DN 200, incluida, son PN10/16. Para DN 250 a DN 1000 indicar que taladro se requiere.

** Con brida fija.

CODOS 11° 15' EMBRIDADOS EN FUNDICIÓN DÚCTIL CON BRIDA MÓVIL

PN 10 - PN 16

Referencia	DN	€/Ud.
666050111018	50	54,70
666060111018	60	59,93
666065111018	65	59,93
666080111018	80	69,04
666100111018	100	83,37
666125111018	125	96,40
666150111018	150	128,97
666200111018	200	183,68
666250111018	250*	392,20
666300111018	300*	562,49
666350111018	350*	965,87
666400111018	400*	965,87
666450111018	450*	1.688,87
666500111018	500*	1.688,87
666600111018	600*	3.189,32
666700111018	700**	5.447,66
666800111018	800**	8.370,39
666900111018	900**	10.045,30
666001111018	1000**	11.718,82

También disponibles en PN25

* Las referencias hasta DN 200, incluida, son PN10/16. Para DN 250 a DN 1000 indicar que taladro se requiere.

** Con brida fija.



También disponible en color rojo para saneamiento y aguas residuales. **PRECIOS CONSULTAR**



También disponible en color rojo para saneamiento y aguas residuales. **PRECIOS CONSULTAR**



* ACS sólo para accesorios azules



TÉS EMBRIDADAS EN FUNDICIÓN DÚCTIL CON BRIDA MÓVIL

PN 10 - PN 16

Referencia	DN	€/Ud.
666040040016	40 x 40	78,16
666050040018	50 x 40	78,16
666050050016	50 x 50	78,16
666060040018	60 x 40	92,50
666060050018	60 x 50	92,50
666060060016	60 x 60	92,50
666065040018	65 x 40	92,50
666065050018	65 x 50	92,50
666065060016	65 x 60	92,50
666065065016	65 x 65	92,50
666080040018	80 x 40	112,03
666080050018	80 x 50	112,03
666080060018	80 x 60	112,03
666080065018	80 x 65	112,03
666080080016	80 x 80	112,03
666100040018	100 x 40	123,76
666100050018	100 x 50	123,76
666100060018	100 x 60	123,76
666100065018	100 x 65	123,76
666100080018	100 x 80	123,76
666100100016	100 x 100	123,76
666125040018	125 x 40	160,23
666125050018	125 x 50	160,23
666125060018	125 x 60	160,23
666125065018	125 x 65	160,23
666125080018	125 x 80	160,23
666125100018	125 x 100	160,23
666125125016	125 x 125	160,23
666150040018	150 x 40	211,04
666150050018	150 x 50	211,04
666150060018	150 x 60	211,04
666150065018	150 x 65	211,04
666150080018	150 x 80	211,04
666150100018	150 x 100	211,04
666150125018	150 x 125	211,04
666150150016	150 x 150	211,04
666175080016	175 x 80	316,56
666175100016	175 x 100	316,56
666175125016	175 x 125	333,49
666175150016	175 x 150	333,49
666175175016	175 x 175	342,62
666200050016	200 x 50	300,93

Referencia	DN	€/Ud.
666200060016	200 x 60	300,93
666200065016	200 x 65	300,93
666200080016	200 x 80	300,93
666200100018	200 x 100	300,93
666200125018	200 x 125	300,93
666200150018	200 x 150	300,93
666200175016	200 x 175	376,49
666200200016	200 x 200	300,93
666250040016	250 x 40*	646,23
666250050016	250 x 50*	646,23
666250060016	250 x 60*	646,23
666250065016	250 x 65*	646,23
666250080018	250 x 80*	646,23
666250100018	250 x 100*	646,23
666250125018	250 x 125*	646,23
666250150018	250 x 150*	646,23
666250175016	250 x 175*	646,23
666250200018	250 x 200*	646,23
666250250016	250 x 250*	646,23
666300040016	300 x 40*	928,17
666300050016	300 x 50*	928,17
666300060016	300 x 60*	928,17
666300065016	300 x 65*	928,17
666300080016	300 x 80*	928,17
666300100016	300 x 100*	928,17
666300125016	300 x 125*	928,17
666300150018	300 x 150*	928,17
666300200018	300 x 200*	928,17
666300250018	300 x 250*	928,17
666300300016	300 x 300*	928,17
666350080016	350 x 80*	1.688,87
666350100016	350 x 100*	1.688,87
666350125016	350 x 125*	1.688,87
666350150016	350 x 150*	1.688,87
666350200018	350 x 200*	1.688,87
666350250018	350 x 250*	1.688,87
666350300018	350 x 300*	1.688,87
666350350016	350 x 350*	1.688,87
666400080016	400 x 80*	1.688,87
666400100016	400 x 100*	1.688,87
666400125016	400 x 125*	1.688,87
666400150016	400 x 150*	1.688,87



*ACS sólo para accesorios azules



TÉS EMBRIDADAS EN FUNDICIÓN DÚCTIL CON BRIDA MÓVIL

PN 10 - PN 16

Referencia	DN	€/Ud.
666400200016	400 x 200*	1.995,95
666400250116	400 x 250*	1.995,95
666400300116	400 x 300*	1.995,95
666400350116	400 x 350*	1.995,95
666400400016	400 x 400*	1.995,95
666450450016	450 x 450*	2.763,60
666500100016	500 x 100*	3.070,68
666500150018	500 x 150*	3.070,68
666500200016	500 x 200*	3.070,68
666500250116	500 x 250*	3.070,68
666500300116	500 x 300*	3.070,68
666500350116	500 x 350*	3.070,68
666500400116	500 x 400*	3.070,68
666500500016	500 x 500*	3.070,68
666600100016	600 x 100*	5.066,61
666600150016	600 x 150*	5.066,61

Referencia	DN	€/Ud.
666600200016	600 x 200*	5.066,61
666600250016	600 x 250*	5.066,61
666600300016	600 x 300*	5.066,61
666600400116	600 x 400*	5.066,61
666600500116	600 x 500*	5.066,61
666600600016	600 x 600*	5.066,61
666700700016	700 x 700**	7.676,68
666800800016	800 x 800**	10.747,36
666900900016	900 x 900**	15.199,84
666001001016	1000 x 1000**	18.424,07

* Las referencias hasta DN 200, incluida, son PN10/16. Para DN 250 a DN 1000 indicar que taladro se requiere.

** Con brida fija.

También disponible en color rojo para saneamiento y aguas residuales. **PRECIOS CONSULTAR**



* ACS sólo para accesorios azules



REDUCCIONES EN FUNDICIÓN DÚCTIL CON BRIDA MÓVIL

PN 10 - PN 16

Referencia	DN	€/Ud.
666050040016	50 x 40	48,21
666060040016	60 x 40	48,21
666060050016	60 x 50	48,21
666065040016	65 x 40	48,21
666065050016	65 x 50	48,21
666080040016	80 x 40	59,93
666080050016	80 x 50	59,93
666080060016	80 x 60	59,93
666080065016	80 x 65	59,93
666100040016	100 x 40	78,16
666100050016	100 x 50	78,16
666100060016	100 x 60	78,16
666100065016	100 x 65	78,16
666100080016	100 x 80	78,16
666125040016	125 x 40	100,31
666125050016	125 x 50	100,31
666125060016	125 x 60	100,31
666125065016	125 x 65	100,31
666125080016	125 x 80	100,31
666125100016	125 x 100	100,31
666150040016	150 x 40	118,54
666150050016	150 x 50	118,54
666150060016	150 x 60	118,54
666150065016	150 x 65	118,54
666150080016	150 x 80	118,54
666150100016	150 x 100	118,54
666150125016	150 x 125	118,54
666200080116	200 x 80	166,75
666200100016	200 x 100	166,75
666200125016	200 x 125	166,75
666200150016	200 x 150	166,75
666250080016	250 x 80*	251,23
666250100016	250 x 100*	251,23

Referencia	DN	€/Ud.
666250125016	250 x 125*	251,23
666250150016	250 x 150*	251,23
666250200016	250 x 200*	251,23
666300150016	300 x 150*	488,53
666300200016	300 x 200*	488,53
666300250016	300 x 250*	488,53
666350200016	350 x 200*	997,96
666350250016	350 x 250*	997,96
666350300016	350 x 300*	997,96
666400200016	400 x 200*	1.995,95
666400250016	400 x 250*	1.074,73
666400300016	400 x 300*	1.074,73
666400350016	400 x 350*	1.074,73
666450300016	450 x 300*	1.504,63
666450400016	450 x 400*	1.504,63
666500250016	500 x 250*	2.303,00
666500300016	500 x 300*	2.303,00
666500350016	500 x 350*	2.303,00
666500400016	500 x 400*	2.303,00
666500450016	500 x 450*	2.303,00
666600400016	600 x 400*	2.456,55
666600500016	600 x 500*	2.456,55
666700300016	700 x 300**	4.145,42
666700500016	700 x 500**	4.145,42
666700600016	700 x 600**	4.145,42
666800500016	800 x 500**	5.876,15
666800600016	800 x 600**	5.876,15
666800700016	800 x 700**	5.876,15
666900700016	900 x 700**	8.265,69
666900800016	900 x 800**	8.265,69
666100800016	1000 x 800**	12.186,40
666100900016	1000 x 900**	12.186,40

También disponibles en PN25

* Las referencias hasta DN 200, incluida, son PN10/16. Para DN 250 a DN 1000 indicar que taladro se requiere.

** Con brida fija.

También disponible en color rojo para saneamiento y aguas residuales. **PRECIOS CONSULTAR**



*ACS sólo para accesorios azules



CRUCETAS EN FUNDICIÓN DÚCTIL CON BRIDA MÓVIL

PN 10 - PN 16

Referencia	DN	€/Ud.
666040000025	40 x 40	209,74
666050000025	50 x 50	209,74
666060050025	60 x 50	225,36
666060000025	60 x 60	225,36
666065050025	65 x 50	225,36
666065060025	65 x 60	225,36
666065000025	65 x 65	225,36
666080050025	80 x 50	300,93
666080060025	80 x 60	300,93
666080065025	80 x 65	300,93
666080000025	80 x 80	300,93
666100050025	100 x 50	356,94
666100060025	100 x 60	356,94
666100065025	100 x 65	356,94
666100080025	100 x 80	356,94
666100000025	100 x 100	356,94
666125080025	125 x 80	409,05
666125100025	125 x 100	409,05

Referencia	DN	€/Ud.
666125000025	125 x 125	409,05
666150080025	150 x 80	455,95
666150100025	150 x 100	455,95
666150000025	150 x 150	455,95
666200100025	200 x 100	695,65
666200150025	200 x 150	695,65
666200000025	200 x 200	1.079,95
666300000025	300 x 300*	1.619,09
666350350025	350 x 350*	3.070,68
666400000025	400 x 400*	6.314,43
666450000025	450 x 450*	9.212,03
666500000025	500 x 500*	9.212,03
666600000025	600 x 600*	12.282,71
666700000025	700 x 700**	15.353,38
666800000025	800 x 800**	18.424,07
666900000025	900 x 900**	21.494,73
666001001025	1000 x 1000**	27.636,08

También disponibles en PN25

* Las referencias hasta DN 200, incluida, son PN10/16. Para DN 250 a DN 1000 indicar que taladro se requiere.

** Con brida fija.

También disponible en color rojo para saneamiento y aguas residuales. **PRECIOS CONSULTAR**



CINTAS DE SEÑALIZACIÓN

Referencia		Descripción	€/m	
A=15 cm	A=30 cm		A=15 cm	A=30 cm
CSA000500015	CSA000500030	¡ATENCIÓN! Tubería de Agua Potable	0,10	0,18
CSA1HC500015	CSA1HC500030	¡ATENCIÓN! Tubería de Agua Potable (con 1 hilo de cobre)	0,23	0,46
CSA2HC500015	CSA2HC500030	¡ATENCIÓN! Tubería de Agua Potable (con 2 hilos de cobre)	0,37	0,72
CSG000500015	CSG000500030	Canalización de Gas	0,10	0,18
CST000500015	CST000500030	Servicios de Telecomunicaciones	0,10	0,18
CSE000500015	CSE000500030	¡ATENCIÓN! Debajo hay Cables Eléctricos	0,10	0,18

Tubería de PVC-U presión

Tubería
PVC-U
INDUSTRIA



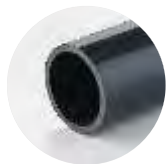

INDUSTRIA

Tubería de PVC-U presión

Tubería



UN EN 1452-2
PN6 - 10 - 12,5 - 16 - 20
e 16 ± 500 mm



NF EN 1452
PN6 - 10 - 16 - 25
e 16 ± 315 mm



DIN 8061 - 62
Hahn 4, Hahn 5
PN 10 - 16



Características principales de las tuberías de PVC-U

Gama

PN 6 : desde d.63 hasta d.400 mm

PN 10 : desde d.63 hasta d.315 mm

PN16 : desde d.20 hasta d.225 mm

La tubería cumple con la norma EN ISO 1452 para el transporte de fluidos bajo presión (agua potable, riego y aguas residuales). Tiene la marca de calidad IIP conforme a D.M. 174 DD. (agua para consumo humano), y según norma EN 1622, análisis de agua, determinación del umbral de olor (TON) y sabor (TFN).

Requisitos higiénicos

Los tubos Lareter U-PVC para conductos de presión cumplen requisitos higiénicos según el "Ministerio de Salud italiano" D.M.21.03.1973 y D.M. 174/2004.

Francia: certificación A.C.S. (Atestación de Conformité Sanitaire)

Gran Bretaña: aprobado por WRAS (Water Regulations Advisory Scheme) producto.

Alemania: potabilidad publicada por Hygiene-Institut en nombre de DVGW

PN6

Ø	Ref.	Espesor	Longitud (m)	Tubos/pallet	Cantidad mínima por pedido (m) (pallet completo)	€
63	048675FIP	2	5	123	615	5,32
75	04868FIP	2,2	5	87	435	7,39
90	048690FIP	2,8	5	96	480	10,25
110	04870FIP	2,7	5	57	285	12,19
125	048700FIP	3,1	5	51	255	15,97
140	048701FIP	3,5	5	45	225	19,98
160	048702FIP	4	5	33	165	25,88
200	0486910FIP	4,9	5	20	100	39,68
225	048705FIP	5,5	5	18	90	50,16
250	047142FIP	6,2	5	12	60	62,92
280	048707FIP	6,9	5	11	55	78,15
315	048708FIP	7,7	5	9	45	98,36
400	047016FIP	9,8	5	5	25	165,40

PN10

63	04875FIP	3	5	123	615	7,23
75	04876FIP	3,6	5	87	435	10,13
90	04877FIP	4,3	5	96	480	14,55
110	04878FIP	4,2	5	57	285	17,58
125	04879FIP	4,8	5	51	255	22,63
140	04880FIP	5,4	5	45	225	28,93
160	04881FIP	6,2	5	33	165	37,63
180	04882FIP	6,9	5	28	140	50,30
200	04883FIP	7,7	5	20	100	58,45
225	04884FIP	8,6	5	18	90	73,40
250	048850FIP	9,6	5	12	60	90,90
280	048492FIP	10,7	5	11	55	113,18
315	04887FIP	12,1	5	9	45	144,44

PN16

20	048741FIP	1,5	5	1166	5830	1,89
25	048740FIP	1,9	5	757	3785	2,92
32	048742FIP	2,4	5	449	2245	3,32
40	048743FIP	3	5	275	1375	4,37
50	048744FIP	3,7	5	194	970	6,74
63	048745FIP	4,7	5	123	615	10,72
75	048746FIP	5,6	5	87	435	15,17
90	048747FIP	6,7	5	96	480	21,75
110	048748FIP	6,6	5	57	285	26,68
125	048749FIP	7,4	5	51	255	34,01
140	048750FIP	8,3	5	45	225	43,15
160	048751FIP	9,5	5	33	165	56,27
180	048752FIP	10,7	5	28	140	71,14
200	048753FIP	11,9	5	20	100	87,76
225	048754FIP	13,4	5	20	100	111,25

Tubería PVC-U extremo plano.

Accesorios encolados, mixtos y roscados

Colectores

Bridas y adaptadores

Uniones 3 piezas

Soportes y abrazaderas

Adhesivos y disolventes

Accesorios de PVC-U presión

INDUSTRIA



Roscas

Perfectas, bien inyectadas y con exactitud milimétrica, ayudan a una perfecta unión suave y fiable con profesionalidad y calidad.



Nervios de tope

Permiten que el tubo sólo penetre hasta el tope.

El pegamento sobrante en su interior se escurre por dentro de la pieza sin cerrar el diámetro interior.

Lineas cada 45°

Ayudan en el montaje para encarar perfectamente los codos y las tes. Con ellas podemos hacer premontajes exactos fuera del lugar donde finalmente se va a colocar, cuando el acceso es complicado.

PVC-U

Packs

Material embolsado hasta diámetro 63 mm. Permite tener las piezas limpias y ordenadas en todo momento. Facilita el contar los stocks así como los inventarios.



Bocas achaflanadas

Ayudan que el tubo entre más fácilmente. El pegamento sobrante se queda depositado en la zona, cerrando y sellando la unión aún con poco pegamento.

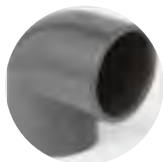
**GIV**

A-B

d	Ref.	PN	Pack	U/	€
12	GIV012	16	10	1.000	1,36
16	GIV016	16	10	500	0,70
20	GIV020	16	10	260	0,70
25	GIV025	16	10	150	0,86
32	GIV032	16	10	150	1,30
40	GIV040	16	10	50	1,85
50	GIV050	16	-	60	2,73
63	GIV063	16	-	50	4,11
75	GIV075	16	-	16	7,68
90	GIV090	16	-	20	12,95
110	GIV110	16	-	10	24,09
125	GIV125	16	-	6	34,67
140	GIV140	16	-	5	59,34
160	GIV160	16	-	4	69,20
180°A)	GIV180	10	-	4	101,92
200°A)	GIV200	16	-	2	108,51
225°A)	GIV225	16	-	2	157,91
250	GIV250	10	-	1	378,63
280	GIV280	10	-	1	705,21
315	GIV315	10	-	1	662,58
400*	GIV400	5	-	1	1.364,29
500*	GIV500	Sólo se fabrica en curva			

Codo 90° encolar.
H-H encolar.

A) Factor de seguridad reducido

**GIFVO***

A

d x Rh	Ref.	PN	U/	€
16 x 1/2"	GIFVO016012	16	5	30,70
20 x 1/2"	GIFVO020012	16	5	32,89
25 x 3/4"	GIFVO025034	16	5	62,63

Codo 90° mixto PVC-U / latón.
H-H encolar-rosca latón.**GIFV**

A

d x Rh	Ref.	PN	Pack	U/	€
16 x 3/8"	GIFV016038	16	10	400	1,40
20 x 1/2"	GIFV020012	16	10	260	1,43
25 x 3/4"	GIFV025034	16	10	150	1,65
32 x 1"	GIFV032100	16	10	150	2,22
40 x 1 1/4"	GIFV040114	16	10	40	2,91
50 x 1 1/2"	GIFV050112	16	10	40	4,30
63 x 2"	GIFV063200	16	-	50	6,08
75 x 2 1/2"	GIFV075212	16	-	16	18,79
90 x 3"	GIFV090300	16	-	9	28,20
110 x 4"	GIFV110400	16	-	10	43,41

Codo 90° mixto.
H-H encolar-rosca.**GIMV**

A

d x Rh	Ref.	PN	Pack	U/	€
16 x 3/8"	GIMV016038	16	10	500	2,65
20 x 1/2"	GIMV020012	16	10	260	2,87
25 x 3/4"	GIMV025034	16	10	150	3,38
32 x 1"	GIMV032100	16	10	80	4,31
40 x 1 1/4"	GIMV040114	16	10	40	5,52
50 x 1 1/2"	GIMV050112	16	10	30	7,91
63 x 2"	GIMV063200	16	5	45	10,45

Codo 90° mixto reforzado inox.
H-H encolar-rosca.**GFV**

A

Rh	Ref.	PN	Pack	U/	€
3/8"	GFV038	16	10	400	1,66
1/2"	GFV012	16	10	260	1,66
3/4"	GFV034	16	10	150	1,97
1"	GFV100	16	10	150	2,64
1 1/4"	GFV114	16	10	40	3,78
1 1/2"	GFV112	16	10	40	5,32
2"	GFV200	16	-	50	7,39
2 1/2"	GFV212	16	-	16	20,08
3"	GFV300	16	-	9	29,76
4"	GFV400	16	-	10	48,88

Codo 90° roscado.
H-H rosca.



HIV

A-B

d	Ref.	PN	Pack	U/ 	€
12	HIV012	16	10	800	2,31
16	HIV016	16	250	1.000	0,95
20	HIV020	16	10	360	0,95
25	HIV025	16	10	200	1,22
32	HIV032	16	10	100	1,65
40	HIV040	16	10	50	2,22
50	HIV050	16	-	40	2,98
63	HIV063	16	-	30	4,31
75	HIV075	16	-	12	8,54
90	HIV090	16	-	6	12,67
110	HIV110	16	-	6	21,37
125	HIV125	16	-	10	31,09
140	HIV140	16	-	6	50,08
160	HIV160	16	-	4	61,20
180*	HIV180	10	-	1	191,33
200	HIV200	10	-	2	90,64
225	HIV225	10	-	2	178,72
250	HIV250	10	-	1	309,87
280	HIV280	10	-	1	615,44
315	HIV315	10	-	1	584,80
400*	HIV400	5	-	1	1.145,39

Codo 45° encolar.

H-H encolar.

HFV

A

Rh	Ref.	PN	Pack	U/ 	€
½"	HFV012	16	10	300	2,01
¾"	HFV034	16	10	200	2,34
1"	HFV100	16	10	120	3,05
1¼"	HFV114	16	5	60	3,86
1½"	HFV112	16	5	30	5,88
2"	HFV200	16	-	30	8,35
2½"	HFV212	16	-	12	30,18
3"	HFV300	16	-	6	39,91

Codo 45° roscado.

H-H roscar.



SIV

A-B

d	Ref.	PN	Pack	U/📦	€
20	SIV020	16	5	140	2,29
25	SIV025	16	5	80	2,84
32	SIV032	16	5	45	4,07
40	SIV040	16	-	20	5,37
50	SIV050	16	-	40	8,15
63	SIV063	16	-	24	13,11
75	SIV075	16	-	15	23,41
90	SIV090	16	-	8	52,06
110	SIV110	16	-	5	92,72
160 A)	SIV160	16	-	4	221,94
180*	SIV180	4	-	1	461,82
200*	SIV200	4	-	1	484,02
225*A)	SIV225	4	-	1	530,54
250*	SIV250	4	-	1	566,65
280*	SIV280	4	-	1	759,50
315*	SIV315	4	-	1	1.169,38
355*	SIV355	4	-	1	1.413,71
400*	SIV400	4	-	1	1.590,70
500*	SIV500	4	-	1	5.582,52

Curva a 90° encolar.
 H-H encolar. R=2d

A) Factor de seguridad reducido



SIMV*

A

d	Ref.	PN	U/📦	€
50	SIMV050	10	1	94,89
63	SIMV063	10	1	108,92
75	SIMV075	10	1	134,35
90	SIMV090	10	1	179,17
110	SIMV110	10	1	365,23
125	SIMV125	10	1	375,30

Curva a 90° encolar.
 M-H encolar. R=3d



SIHM*

A

d	Ref.	PN	U/📦	€
50	SIHM050	10	1	86,15
63	SIHM063	10	1	96,78
75	SIHM075	10	1	106,10
90	SIHM090	10	1	149,09
110	SIHM110	10	1	243,66
125	SIHM125	10	1	351,03

Curva a 45° encolar.
 M-H encolar. R=3d



SIHV*

B

d	Ref.	PN	U/📦	€
315	SIHV315	4	1	840,51
355	SIHV355	4	1	1.066,91
400	SIHV400	4	1	1.291,09
500	SIHV500	4	1	4.065,33

Curva a 45° encolar.
 H-H encolar.



SIV 22*

A

d	Ref.	PN	U/📦	€
90	SIV22090	10	1	143,19
110	SIV22110	10	1	229,51
125	SIV22125	10	1	334,00

Curva a 22° 30' encolar.
 M-H encolar.



SIV 11*

A

d	Ref.	PN	U/📦	€
90	SIV11090	10	1	136,45
110	SIV11110	10	1	262,36
125	SIV11125	10	-	381,24

Curva a 11° 15' encolar.
 M-H encolar.



XIV

A

d	Ref.	PN	Pack	U/	€
25	XIV025	16	10	80	2,33
32	XIV032	16	10	50	3,38
40	XIV040	16	10	40	5,52
50	XIV050	16	10	20	7,46
63	XIV063	16	-	12	10,58
75*	XIV075	10	-	10	48,03
90*	XIV090	10	-	12	72,50
110*	XIV110	10	-	7	91,22

Cruz a 90° encolar.
H-H-H encolar.



YIV

A

d	Ref.	PN	U/	€
20	YIV020	16	200	4,11
25	YIV025	16	100	4,76
32	YIV032	16	60	5,35
40	YIV040	16	50	7,27
50	YIV050	16	20	7,61
63	YIV063	16	15	10,88
75*	YIV075	10	12	50,03
90*	YIV090	10	12	74,87
110*	YIV110	10	8	153,35
160*	YIV160	4	1	239,60

Te a 45° encolar.
H-H-H encolar.



TIV

A-B

d	Ref.	PN	Pack	U/	€
12	TIV012	16	10	500	1,62
16	TIV016	16	10	300	0,85
20	TIV020	16	10	200	0,85
25	TIV025	16	10	100	1,12
32	TIV032	16	10	100	1,59
40	TIV040	16	10	60	2,62
50	TIV050	16	5	60	3,73
63	TIV063	16	-	30	5,34
75	TIV075	16	-	22	11,16
90	TIV090	16	-	12	20,52
110	TIV110	16	-	8	30,01
125	TIV125	16	-	6	49,17
140	TIV140	16	-	6	74,70
160	TIV160	16	-	5	88,24
180*	TIV180	16	-	3	122,27
200 A)	TIV200	16	-	2	141,43
225 A)	TIV225	16	-	1	196,46
250	TIV250	10	-	1	433,83
280	TIV280	10	-	1	869,19
315	TIV315	10	-	1	783,11
400*	TIV400	4	-	1	1.938,62
500*	TIV500	4	-	1	5.893,82

Te igual a 90° encolar.
H-H-H encolar.

A) Factor de seguridad reducido



TIFV

A

d x Rh	Ref.	PN	Pack	U/	€
16 x 3/8"	TIFV016038	16	10	300	1,70
20 x 1/2"	TIFV020012	16	10	180	1,81
25 x 1/2**	TIFV025012	16	-	-	3,07
25 x 3/4"	TIFV025034	16	10	100	2,06
32 x 1/2"	TIFV032012	16	10	100	2,64
32 x 3/4**	TIFV032034	16	-	-	4,02
32 x 1"	TIFV032100	16	10	80	2,60
40 x 1/2**	TIFV040012	16	-	-	5,53
40 x 3/4**	TIFV040034	16	-	-	5,53
40 x 1**	TIFV040100	16	-	-	5,53
40 x 1 1/4"	TIFV040114	16	10	60	4,24
50 x 1/2"	TIFV050012	16	5	40	6,04
50 x 3/4**	TIFV050034	16	-	-	8,28
50 x 1**	TIFV050100	16	-	-	8,28
50 x 1 1/2"	TIFV050112	16	5	60	5,80
63 x 1/2"	TIFV063012	16	-	45	9,42
63 x 3/4**	TIFV063034	16	-	-	13,58
63 x 1**	TIFV063100	16	-	-	13,58
63 x 1 1/4**	TIFV063114	16	-	-	13,58
63 x 1 1/2**	TIFV063112	16	-	-	13,58
63 x 2"	TIFV063200	16	-	35	9,45
75 x 2 1/2"	TIFV075212	16	-	12	21,66
90 x 3"	TIFV090300	16	-	12	32,49
110 x 4"	TIFV110400	16	-	8	53,77

Te a 90° mixta.
H-H-H encolar-rosacar.

**TIMV**

A

d x Rh	Ref.	PN	Pack	U/📦	€
16 x 3/8"	TIMV016038	16	10	180	2,93
20 x 1/2"	TIMV020012	16	10	180	3,27
25 x 3/4"	TIMV025034	16	10	100	3,79
32 x 1"	TIMV032100	16	10	60	4,71
40 x 1 1/4"	TIMV040114	16	10	30	6,76
50 x 1 1/2"	TIMV050112	16	5	20	9,40
63 x 2"	TIMV063200	16	-	10	13,67

Te a 90° mixta reforzada inox.

H-H-H encolar-rosocar.

**TFV**

A

Rh	Ref.	PN	Pack	U/📦	€
3/8"	TFV038	16	10	300	2,19
1/2"	TFV012	16	10	180	2,60
3/4"	TFV034	16	10	90	2,84
1"	TFV100	16	10	80	3,50
1 1/4"	TFV114	16	10	60	5,52
1 1/2"	TFV112	16	5	60	7,71
2"	TFV200	16	-	30	12,31
2 1/2"	TFV212	16	-	12	24,99
3"	TFV300	16	-	12	33,12
4"	TFV400	16	-	8	60,63

Te a 90° roscada.

H-H-H roscar.

**TRIV**

A-B

d x dr	Ref.	PN	Pack	U/📦	€
25 x 20	TRIV025020	16	10	120	1,39
32 x 20	TRIV032020	16	10	100	1,90
32 x 25	TRIV032025	16	10	90	1,90
40 x 20	TRIV040020	16	10	60	3,27
40 x 25	TRIV040025	16	10	60	3,27
40 x 32	TRIV040032	16	10	60	3,27
50 x 20	TRIV050020	16	5	40	4,27
50 x 25	TRIV050025	16	5	70	4,27
50 x 32	TRIV050032	16	5	60	4,27
50 x 40	TRIV050040	16	5	30	4,27
63 x 25	TRIV063025	16	-	45	7,11
63 x 32	TRIV063032	16	-	45	7,11
63 x 40	TRIV063040	16	-	45	7,11
63 x 50	TRIV063050	16	-	40	7,11
75 x 32	TRIV075032	16	-	18	12,06
75 x 40	TRIV075040	16	-	16	12,06
75 x 50	TRIV075050	16	-	13	12,06
75 x 63	TRIV075063	16	-	12	12,06
90 x 40	TRIV090040	16	-	15	21,33
90 x 50	TRIV090050	16	-	15	21,33
90 x 63	TRIV090063	16	-	12	21,33
90 x 75	TRIV090075	16	-	12	21,33

Te a 90° reducida encolar.

H-H-H encolar.

d x dr	Ref.	PN	Pack	U/📦	€
110 x 50	TRIV110050	16	-	10	30,54
110 x 63	TRIV110063	16	-	8	30,54
110 x 75	TRIV110075	16	-	8	30,54
110 x 90	TRIV110090	16	-	8	30,54
125 x 50*	TRIV125050	16	-	1	102,96
125 x 63*	TRIV125063	16	-	1	102,96
125 x 75*	TRIV125075	16	-	1	102,96
125 x 90*	TRIV125090	16	-	1	102,96
125 x 110*	TRIV125110	16	-	1	102,96
160 x 110	TRIV160110	16	-	3	90,02
200 x 90*	TRIV200090	10	-	1	296,37
200 x 110*	TRIV200110	10	-	1	296,37
200 x 160*	TRIV200160	10	-	1	296,37
250 x 110*	TRIV250110	10	-	1	490,67
250 x 160*	TRIV250160	10	-	1	490,67
250 x 200*	TRIV250200	10	-	1	490,67
280 x 225*	TRIV280225	10	-	1	743,61
315 x 200*	TRIV315200	8	-	1	912,27
315 x 250*	TRIV315250	8	-	1	912,27
400 x 110*	TRIV400110	5	-	1	1.311,34
400 x 315*	TRIV400315	4	-	1	1.938,62
400 x 355*	TRIV400355	4	-	1	1.938,62



MIV

A-B

d	Ref.	PN	Pack	U/	€
12	MIV012	16	10	1.000	1,35
16	MIV016	16	10	600	0,81
20	MIV020	16	10	360	0,80
25	MIV025	16	10	270	0,95
32	MIV032	16	10	150	1,12
40	MIV040	16	10	80	1,66
50	MIV050	16	10	40	2,15
63	MIV063	16	-	40	3,16
75	MIV075	16	-	24	6,51
90	MIV090	16	-	28	8,39
110	MIV110	16	-	24	13,90
125	MIV125	16	-	14	21,37
140	MIV140	16	-	8	31,64
160	MIV160	16	-	6	42,80
180*	MIV180	4	-	1	139,68
200 A)	MIV200	16	-	6	64,03
225 A)	MIV225	16	-	2	104,55
250	MIV250	10	-	2	212,98
280	MIV280	10	-	2	345,30
315	MIV315	10	-	1	298,60
355*	MIV355	5	-	1	460,78
400*	MIV400	5	-	1	512,29
500*	MIV500	4	-	1	647,98

Manguito encolar.

H-H encolar.

A) Factor de seguridad reducido



MIFV

A

d x Rh	Ref.	PN	Pack	U/	€
16 x 3/8"	MIFV016038	16	10	600	1,44
20 x 1/2"	MIFV020012	16	10	300	1,44
25 x 3/4"	MIFV025034	16	10	200	1,65
32 x 1"	MIFV032100	16	10	100	1,83
40 x 1 1/4"	MIFV040114	16	10	80	2,41
50 x 1 1/2"	MIFV050112	16	10	40	3,12
63 x 2"	MIFV063200	16	-	25	4,44
75 x 2 1/2**	MIFV075212	16	-	75	18,76
90 x 3**	MIFV090300	16	-	40	20,73
110 x 4**	MIFV110400	16	-	25	29,61

Manguito mixto.

H-H encolar-rosocar.



MIMV

A

d x Rh	Ref.	PN	Pack	U/	€
16 x 3/8"	MIMV016038	16	10	600	2,73
20 x 1/2"	MIMV020012	16	10	400	2,96
25 x 3/4"	MIMV025034	16	10	240	3,38
32 x 1"	MIMV032100	16	10	120	3,94
40 x 1 1/4"	MIMV040114	16	10	80	5,00
50 x 1 1/2"	MIMV050112	16	10	40	6,52
63 x 2"	MIMV063200	16	5	25	8,65

Manguito mixto reforzado inox.

H-H encolar-rosocar.



MIFVO*

A

dm x dh x Rh	Ref.	PN	Pack	U/	€
20 x 16 x 3/8"	MIFVO016038	16	10	600	29,82
25 x 20 x 1/2"	MIFVO020012	16	10	400	29,82
32 x 25 x 3/4"	MIFVO025034	16	10	240	40,44
40 x 32 x 1"	MIFVO032100	16	10	120	57,42
50 x 40 x 1 1/4"	MIFVO040114	16	10	80	65,23
63 x 50 x 1 1/2"	MIFVO050112	16	10	40	86,41
75 x 63 x 2"	MIFVO063200	16	5	25	114,15

Manguito mixto.

H-M encolar - H rosocar latón.

dm = diám.macho dh = diám.hembra
 Rh = rosca hembra latón

**MFV**

A

Rh	Ref.	PN	Pack	U/ 	€
3/8"	MFV038	16	10	600	1,71
1/2"	MFV012	16	10	300	1,70
3/4"	MFV034	16	10	240	1,98
1"	MFV100	16	10	100	2,40
1 1/4"	MFV114	16	10	80	3,12
1 1/2"	MFV112	16	10	40	4,24
2"	MFV200	16	-	25	5,65
2 1/2"	MFV212	16	-	20	13,68
3"	MFV300	16	-	8	19,25
4"	MFV400	16	-	10	29,92

Manguito roscado.

H-H roscar.

**DIMV**

A

dm x dh x Rh	Ref.	PN	Pack	U/ 	€
20 x 16 x 3/8"	DIMV20016038	16	10	500	4,03
20 x 16 x 1/2"	DIMV20016012	16	10	250	5,34
25 x 20 x 1/2"	DIMV25020012	16	10	300	5,34
25 x 20 x 3/4"	DIMV25020034	16	10	100	6,33
32 x 25 x 3/4"	DIMV32025034	16	10	160	6,37
32 x 25 x 1"	DIMV32025100	16	10	120	6,71
40 x 32 x 1"	DIMV40032100	16	10	100	6,75
40 x 32 x 1 1/4"	DIMV40032114	16	10	40	11,93
50 x 40 x 1 1/4"	DIMV50040114	16	10	40	11,93
50 x 40 x 1 1/2"	DIMV50040112	16	5	30	13,49
63 x 50 x 1 1/2"	DIMV63050112	16	5	30	13,49
63 x 50 x 2"	DIMV63050200	16	5	30	18,32
75 x 63 x 2"	DIMV75063200	16	-	45	18,32

Doble adaptador mixto M/H-H
reforzado inox.

M-H encolar - H roscar.

dm = diám.macho
dh = diám.hembra
Rh = rosca hembra**DIFV**

A

dm x dh x Rh	Ref.	PN	Pack	U/ 	€
20 x 16 x 3/8"	DIFV20016038	16	10	500	1,54
20 x 16 x 1/2"	DIFV20016012	16	10	400	1,54
25 x 20 x 1/2"	DIFV25020012	16	10	300	1,81
25 x 20 x 3/4"	DIFV25020034	16	10	200	1,81
32 x 25 x 3/4"	DIFV32025034	16	10	160	2,42
32 x 25 x 1"	DIFV32025100	16	10	120	2,42
40 x 32 x 1"	DIFV40032100	16	10	100	3,12
40 x 32 x 1 1/4"	DIFV40032114	16	10	80	3,12
50 x 40 x 1 1/4"	DIFV50040114	16	10	60	4,42
50 x 40 x 1 1/2"	DIFV50040112	16	10	40	4,42
63 x 50 x 1 1/2"	DIFV63050112	16	-	30	6,66
63 x 50 x 2"	DIFV63050200	16	-	24	6,66
75 x 63 x 2"	DIFV75063200	16	-	45	9,32
75 x 63 x 2 1/2"	DIFV75063212	16	-	24	9,32
90 x 75 x 2 1/2"	DIFV90075212	16	-	20	16,52
90 x 75 x 3"	DIFV90075300	16	-	8	16,52
110 x 90 x 3"	DIFV11090300	16	-	6	22,58
110 x 90 x 4"	DIFV11090400	16	-	5	22,58
125 x 110 x 4"	DIFV12110400	16	-	6	42,02

Doble adaptador mixto M/H-H.

M-H encolar - H roscar.

dm = diám.macho
dh = diám.hembra
Rh = rosca hembra

QPV PLANO
QRV ESTRIADO

A-B

d	Ref.	PN	Pack	U/ 	€
20 +	QPV020	16	10	500	1,51
25 +	QPV025	16	10	340	1,78
32 +	QPV032	16	10	200	1,93
40	QPV040	16	10	110	2,48
50	QPV050	16	10	80	3,07
63	QPV063	16	-	48	3,78
75	QPV075	16	-	20	5,19
90	QPV090	16	-	48	7,80
110	QPV110	16	-	32	9,78
125	QPV125	16	-	7	12,87
140	QPV140	16	-	8	17,22

Manguito portabridas encolar.
H encolar (junta no incluida).

d	Ref.	PN	Pack	U/ 	€
160	QPV160	16	-	10	23,75
180*	QPV180	16	-	1	91,44
200 A)	QPV200	16	-	6	43,45
225 -- A)	QRV225	16	-	6	51,69
250 -- A)	QRV250	16	-	6	116,05
280* --	QRV280	10	-	4	192,53
315 --	QRV315	10	-	3	180,31
355*+	QPV355	5	-	1	315,38
400*	QRV400	5	-	1	378,51
500*+	QPV500	4	-	1	468,82

+ Sólo QPV -- Sólo QRV

A) Factor de seguridad reducido.

Código portabridas plano, para estriado cambiar QPV por QRV

**FDV**

A

d	Ref.	DN	T PN	U 	€
25	FDV025	20	10	80	6,75
32	FDV032	25	10	48	8,10
40	FDV040	32	10	24	10,57
50	FDV050	40	10	20	12,39
63	FDV063	50	10	14	15,41
75	FDV075	65	10	12	16,19
90	FDV090	75	10	12	18,74
110	FDV110	90	10	6	22,90

Brida con manguito encolar.

T = Taladros

H encolar (junta no incluida).

**QPV FK/FE**

A

d	Ref.	DN	PN	€
125 (2)	QPV125FKE	125	16	53,54
200 (3)	QPV200FKE	200	16	134,62

Portabridas especial para válvula de mariposa FE/FK. (2) Convierte la válvula de mariposa de 140 en 125. Usar con brida ODV 140 PVC-U.
(3) Convierte la válvula de mariposa de 225 en 200. Usar con brida ODV 225 PVC-U.
Para rebajar el diámetro.

**ODB**

T1

d	Ref.	DN	€
20	ODB020	15	7,15
25	ODB025	20	7,86
32	ODB032	25	10,13
40	ODB040	32	12,28
50	ODB050	40	14,36
63	ODB063	50	17,85
75	ODB075	65	19,73
90	ODB090	80	23,50
125*	ODB125	100	28,36
140	ODBD140DN125	125	44,54
180**	ODB180	150	43,19
200	ODB200	200	64,88
225	ODBD225DN200	200	91,52
280	ODBD280DN250	250	94,75
315	ODBD315DN300	300	138,76

Brida loca PP negro con alma de acero.

EN/ISO/DIN - PN 10 / 16 hasta PN 150 - PN 10 DN 200

* Para QPV 110, QRV 110. ** Para QPV 160, QRV 160.

**ODV**

A-B

d	Ref.	T PN	Pack	U 	€
20	ODV020	10	-	250	3,90
25	ODV025	10	-	200	4,47
32	ODV032	10	-	120	4,98
40	ODV040	10	-	60	5,77
50	ODV050	10	-	65	6,50
63	ODV063	10	2	30	7,14
75	ODV075	10	2	16	9,23
90	ODV090	10	2	24	9,85
110	ODV110	10	2	20	13,39
125	ODV125	10	-	16	19,23
140	ODV140	10	-	16	21,86
160	ODV160	10	-	18	26,44
180*	ODV180	10	-	-	84,50
200	ODV200	10	-	9	31,90
225	ODV225	10	-	10	36,30
250	ODV250	10	-	11	103,66
280*	ODV280	10	-	12	151,38
315*	ODV315	10	-	8	157,80
355*	ODV355	4	-	1	254,04
400*	ODV400	4	-	1	273,39
500*	ODV500	6	-	1	409,87
500*	ODV510	10	-	1	452,57

Brida loca para manguito portabridas.

T = Taladros

Brida en PVC-U

**FCV**

A-B

d	Ref.	T PN	Pack	U/ 	€
25	FCV025	10	2	40	6,44
32	FCV032	10	2	60	8,58
40	FCV040	10	2	50	11,19
50	FCV050	10	-	30	13,69
63	FCV063	10	-	30	16,83
75	FCV075	10	2	26	22,10
90	FCV090	10	2	24	25,47
110	FCV110	10	2	18	33,50
140*	FCV140	10	-	1	72,14
160*	FCV160	10	-	1	105,39
180*	FCV180	10	-	1	134,56
200*	FCV200	10	-	1	133,13
225*	FCV225	10	-	1	133,13
250*	FCV250	8	-	1	271,21
280*	FCV280	8	-	1	271,21
315*	FCV315	6	-	1	540,08

Brida Ciega.

T = Taladros

**LIFV**

A

d x Rm x Rh	Ref.	PN	Junta	Pack	U/ 	€
16 x 3/4" x 1/2"	1RAS316B00	16	EPDM	5	125	23,66
20 x 1" x 3/4"	1RAS320C00	16	EPDM	5	125	29,80
25 x 1 1/4" x 1"	1RAS325D00	16	EPDM	5	90	34,02
32 x 1 1/2" x 1"	1RAS332D00	16	EPDM	-	60	42,41
40 x 2" x 1 1/2"	1RAS340F00	16	EPDM	-	35	63,83
16 x 3/4" x 1/2"	1RAS316B10	16	FKM	5	125	20,79
20 x 1" x 3/4"	1RAS320C10	16	FKM	5	125	27,45
25 x 1 1/4" x 1"	1RAS325D10	16	FKM	5	90	31,07
32 x 1 1/2" x 1"	1RAS332D10	16	FKM	-	60	41,94
40 x 2" x 1 1/2"	1RAS340F10	16	FKM	-	35	59,65

Adaptador depósito.

H encolar - M-H rosacar. Junta plana incluida.**LIV**

A

d x Rm	Ref.	PN	Pack	U/ 	€ EPDM
25 x 1"	LIV025100	16	10	100	14,17
32 x 1 1/4"	LIV032114	16	10	40	16,53

Adaptador depósito.

*M-M encolar - rosacar. Junta plana incluida.**M-M encolar - rosacar. Junta plana incluida.*

**LIV-J**

d x Rm x Rh	Ref.	A € EPDM	A € FKM
16 x 3/4" x 1/2"	GP0195E	1,70	6,61
20 x 1" x 3/4"	GP2299E	3,19	18,47
25 x 1 1/4" x 1"	GP0200E	3,69	19,80
32 x 1 1/2" x 1"	GP0201E	4,69	28,51
40 x 2" x 1 1/2"	GP0202E	6,67	46,45

Junta plana para adaptador depósito.

Código en FKM termina en "F"
en lugar de "E"

**LIV-J**

d x Rm	Ref.	A € EPDM
25 x 1"	GP1205E	0,97
32 x 1 1/4"	GP1206E	1,35

Junta plana para adaptador depósito.

Junta en EPDM.

**DIV**

d x d1	Ref.	PN	Pack	U/📦	€
16 x 12	DIV016012	16	10	1.000	1,99
20 x 16	DIV020016	16	10	1.100	0,58
25 x 20	DIV025020	16	10	600	0,71
32 x 20	DIV032020	16	10	400	0,85
32 x 25	DIV032025	16	10	400	0,78
40 x 20	DIV040020	16	10	240	1,25
40 x 25	DIV040025	16	10	240	1,25
40 x 32	DIV040032	16	10	240	0,98
50 x 32	DIV050032	16	10	120	1,70
50 x 40	DIV050040	16	10	120	1,20
63 x 32	DIV063032	16	-	70	2,26
63 x 40	DIV063040	16	-	70	2,26
63 x 50	DIV063050	16	-	60	1,60
75 x 50	DIV075050	16	-	56	3,38
75 x 63	DIV075063	16	-	56	2,85
90 x 50	DIV090050	16	-	100	5,41
90 x 63	DIV090063	16	-	100	5,41
90 x 75	DIV090075	16	-	100	4,68
110 x 63	DIV110063	16	-	60	10,39
110 x 75	DIV110075	16	-	60	10,27
110 x 90	DIV110090	16	-	60	9,04
125 x 110	DIV125110	16	-	12	11,79
140 x 90	DIV140090	16	-	16	16,79
140 x 110	DIV140110	16	-	16	17,92

Casquillo reducción encolar.

M-H encolar.

d = diámetro macho
d1 = diámetro hembra

A-B

d x d1	Ref.	PN	Pack	U/📦	€
140 x 125	DIV140125	16	-	16	15,99
160 x 90	DIV160090	16	-	9	22,71
160 x 110	DIV160110	16	-	9	23,65
160 x 140	DIV160140	16	-	9	20,91
180 x 160*	DIV180160	4	-	1	65,39
200 x 160*	1RRC121O00	16	-	10	40,44
200 x 180*	DIV200180	4	-	1	65,75
225 x 160 A)	DIV225160	16	-	6	54,44
225 x 200 A)*	DIV225200	16	-	6	44,30
250 x 160	DIV250160	10	-	6	94,76
250 x 180*	DIV250180	10	-	1	196,85
250 x 200	DIV250200	10	-	6	81,12
250 x 225	DIV250225	10	-	6	79,48
280 x 200*	DIV280200	10	-	1	222,22
280 x 225*	DIV280225	10	-	4	222,22
280 x 250*	DIV280250	10	-	1	222,22
315 x 200	DIV315200	10	-	3	239,76
315 x 225	DIV315225	10	-	3	243,28
315 x 250	DIV315250	10	-	4	237,91
315 x 280	DIV315280	10	-	4	237,66
400 x 280*	DIV400280	5	-	1	392,43
400 x 315*	DIV400315	5	-	1	339,93
400 x 355*	DIV400355	5	-	1	339,93

A) Factor de seguridad reducido



RIV

A

d x d2 x d1	Ref.	PN	Pack	U/	€
16 x 12	RIV016012	16	10	800	0,91
20 x 16	RIV020016	16	10	500	0,91
25 x 20 x 16	RIV025020016	16	10	400	0,97
25 x 20 x 20	RIV025020020	16	10	340	0,97
32 x 25 x 16	RIV032025016	16	10	280	0,97
32 x 25 x 20	RIV032025020	16	10	240	1,08
32 x 25 x 25	RIV032025025	16	10	200	1,08
40 x 32 x 20	RIV040032020	16	10	120	1,32
40 x 32 x 25	RIV040032025	16	10	120	1,32
40 x 32 x 32	RIV040032032	16	10	120	1,32
50 x 40 x 20	RIV050040020	16	10	80	1,92
50 x 40 x 25	RIV050040025	16	10	80	1,92
50 x 40 x 32	RIV050040032	16	10	80	1,92
50 x 40 x 40	RIV050040040	16	10	60	1,92
63 x 50 x 25	RIV063050025	16	-	40	3,07
63 x 50 x 32	RIV063050032	16	-	40	3,07
63 x 50 x 40	RIV063050040	16	-	40	3,07
63 x 50 x 50	RIV063050050	16	-	35	3,07
75 x 63 x 40*	RIV075063040	16	-	24	5,26

Reducción cónica encolar.

M/H-H encolar.

d = diámetro macho
d2 y d1 = diámetros hembra



MRIV*

A-B

d2 x d1	Ref.	PN	U/	€
125 x 110	MRIV125110	10	1	71,57
140 x 110	MRIV140110	10	1	95,47
140 x 125	MRIV140125	10	1	95,47
160 x 110	MRIV160110	10	1	98,04
160 x 125	MRIV160125	10	1	101,58
160 x 140	MRIV160140	10	1	98,04
200 x 110	MRIV200110	10	1	189,37
200 x 125	MRIV200125	10	1	189,37
200 x 140	MRIV200140	10	1	189,37
200 x 160	MRIV200160	10	1	189,37
200 x 180	MRIV200180	10	1	189,37
225 x 110	MRIV225110	10	1	243,51
225 x 125	MRIV225125	10	1	243,51
225 x 140	MRIV225140	10	1	236,58
225 x 160	MRIV225160	10	1	236,58
225 x 200	MRIV225200	10	1	236,58
250 x 110	MRIV250110	10	1	306,04
250 x 125	MRIV250125	10	1	306,04
250 x 140	MRIV250140	10	1	306,04
250 x 160	MRIV250160	10	1	297,38
250 x 180	MRIV250180	10	1	297,38
250 x 200	MRIV250200	10	1	297,38

Manguito reducido encolar.

H-H encolar.

d x d2 x d1	Ref.	PN	Pack	U/	€
75 x 63 x 50	RIV075063050	16	-	24	4,95
75 x 63 x 63	RIV075063063	16	-	24	4,95
90 x 75 x 50 x 40 B)	RIV090075040	16	-	24	6,44
90 x 75 x 63 x 50 B)	RIV090075050	16	-	16	6,44
90 x 75 x 75 x 63 B)	RIV090075063	16	-	24	6,44
90 x 75 x 90 x 75 B)	RIV090075075	16	-	12	6,44
110 x 90 x 50	RIV110090050	16	-	15	11,75
110 x 90 x 63	RIV110090063	16	-	12	11,75
110 x 90 x 75	RIV110090075	16	-	12	11,75
110 x 90 x 90	RIV110090090	16	-	10	11,75
125 x 110 x 63*	RIV125063	16	-	1	50,81
125 x 110 x 75*	RIV125075	16	-	1	43,17
125 x 110 x 90*	RIV125090	16	-	1	43,17
140 x 125 x 75*	RIV140075	16	-	1	71,94
140 x 125 x 90*	RIV140090	16	-	1	64,76
140 x 125 x 110*	RIV140110	16	-	1	64,76
160 x 140 x 90*	RIV160090	16	-	1	95,95
160 x 110	RIV160110	16	-	12	28,06
200 x 160	RIV200160	16	-	8	61,37

B) 4 diámetros M-H / M-H

d2 y d1 = diámetros hembra

**CIV**

A-B

d	Ref.	PN	Pack	U/	€
12	CIV012	16	10	1.000	1,35
16	CIV016	16	10	1.000	0,72
20	CIV020	16	10	600	0,71
25	CIV025	16	10	400	0,73
32	CIV032	16	10	240	1,00
40	CIV040	16	10	140	1,53
50	CIV050	16	10	80	2,22
63	CIV063	16	-	60	3,07
75	CIV075	16	-	28	5,82
90	CIV090	16	-	15	9,51
110	CIV110	16	-	10	19,23
125	CIV125	16	-	6	26,95
140	CIV140	16	-	4	35,22
160	CIV160	16	-	4	40,71
200*	CIV200	10	-	7	58,58
225	CIV225	10	-	2	95,18
250*	CIV250	10	-	1	202,18

Tapón encolar hembra.

H encolar.**MIRVO***

A

dm x dh x Rh	Ref.	PN	Pack	€
20 x 16 x 3/8"	MIRVO2016038	16	5	29,82
20 x 16 x 1/2"	MIRVO2016012	16	5	49,68
25 x 20 x 1/2"	MIRVO2520012	16	5	29,82
32 x 25 x 3/4"	MIRVO3225034	16	5	40,44
32 x 25 x 1"	MIRVO3225100	16	5	95,72
40 x 32 x 1"	MIRVO4032100	16	5	57,42
50 x 40 x 1 1/4"	MIRVO5040114	16	1	65,23
63 x 50 x 1 1/2"	MIRVO6350112	16	1	86,41
75 x 63 x 2"	MIRVO7563200	16	1	114,14

Terminal roscado macho PVC-U / Latón

M/H encolar - M roscado latón.
 dm = diám. macho
 dh = diám. hembra
 Rm = rosca macho
**CFV**

A

Rh	Ref.	PN	Pack	U/	€
3/8"	1RCA216000	16	10	1.000	1,29
1/2"	CFV012	16	10	500	1,36
3/4"	CFV034	16	10	400	1,51
1"	CFV100	16	10	200	1,87
1 1/4"	CFV114	16	10	140	2,60
1 1/2"	CFV112	16	10	90	3,39
2"	CFV200	16	-	50	4,49
2 1/2"	CFV212	16	-	70	16,77
3"	CFV300	16	-	20	17,19
4"	CFV400	16	-	60	29,61

Tapón rosca hembra.

H roscar.**PFV**

A

Rm	Ref.	PN	Pack	U/	€
3/8"	PFV038	16	10	1.000	0,82
1/2"	PFV012	16	10	300	0,98
3/4"	PFV034	16	10	400	1,18
1"	PFV100	16	10	260	1,66
1 1/4"	PFV114	16	10	120	2,22
1 1/2"	PFV112	16	10	100	2,88
2"	PFV200	16	-	60	3,39
2 1/2"	PFV212	16	-	36	6,03
3"	PFV300	16	-	20	9,70
4"	PFV400	16	-	8	18,99

Tapón rosca macho.

M roscar.**DFV**

A

Rm x Rh	Ref.	PN	Pack	U/	€
1/2" x 3/8"	DFV012038	16	10	600	1,66
3/4" x 1/2"	DFV034012	16	10	400	1,49
1" x 3/4"	DFV100034	16	10	280	1,81
1 1/4" x 1"	DFV114100	16	10	160	2,18
1 1/2" x 1 1/4"	DFV112114	16	10	100	2,57
2" x 1 1/2"	DFV200112	16	-	60	3,90

Reducción roscada corta.

M-H roscar.

**KIFV**

A

dm x dh x Rm	Ref.	PN	Pack	U/	€
16 x 12 x 3/8"	KIFV16012038	16	10	700	0,82
20 x 16 x 3/8"	KIFV20016038	16	10	700	0,93
20 x 16 x 1/2"	KIFV20016012	16	10	700	0,93
25 x 20 x 1/2"	KIFV25020012	16	10	350	1,11
25 x 20 x 3/4"	KIFV25020034	16	10	300	1,11
32 x 25 x 1/2"	KIFV32025012	16	10	220	1,23
32 x 25 x 3/4"	KIFV32025034	16	10	200	1,23
32 x 25 x 1"	KIFV32025100	16	10	180	1,23
40 x 32 x 3/4"	KIFV40032034	16	10	120	1,66
40 x 32 x 1"	KIFV40032100	16	10	120	1,66
40 x 32 x 1 1/4"	KIFV40032114	16	10	100	1,66
50 x 40 x 1"	KIFV50040100	16	10	100	2,15
50 x 40 x 1 1/4"	KIFV50040114	16	10	100	2,15
50 x 40 x 1 1/2"	KIFV50040112	16	10	100	2,13

Terminal rosca macho.

M/H encolar - M rosca.

**NFV**

A

Rh	Ref.	PN	Pack	U/	€
3/8"	NFV038	16	10	800	1,11
1/2"	NFV012	16	10	500	1,17
3/4"	NFV034	16	10	260	1,36
1"	NFV100	16	10	160	1,65
1 1/4"	NFV114	16	10	80	2,06
1 1/2"	NFV112	16	10	70	2,71
2"	NFV200	16	-	30	3,45
2 1/2" A)	NFV212	16	-	24	6,08
3" A)	NFV300	16	-	16	9,50
4" A)	NFV400	16	-	6	22,37

Machón doble rosca.

M-M rosca.

A) Factor de seguridad reducido

dm x dh x Rm	Ref.	PN	Pack	U/	€
63 x 50 x 1 1/4"	KIFV63050114	16	-	80	3,50
63 x 50 x 1 1/2"	KIFV63050112	16	-	80	3,50
63 x 50 x 2"	KIFV63050200	16	-	70	3,45
75 x 63 x 1 1/2"	KIFV75063112	16	-	55	5,56
75 x 63 x 2"	KIFV75063200	16	-	50	5,56
75 x 63 x 2 1/2"	KIFV75063212	16	-	40	5,56
90 x 75 x 2"	KIFV90075200	16	-	30	8,08
90 x 75 x 2 1/2"	KIFV90075212	16	-	30	8,08
90 x 75 x 3"	KIFV90075300	16	-	24	8,08
110 x 90 x 2 1/2"	KIFV11090212	16	-	12	18,68
110 x 90 x 3"	KIFV11090300	16	-	20	18,68
110 x 90 x 4"	KIFV11090400	16	-	12	18,68
125 x 110 x 3"	KIFV12110300	16	-	8	20,37
125 x 110 x 4"	KIFV12110400	16	-	6	20,57

dm = diámetro macho dh = diámetro hembra
Rm = rosca macho**RFV**

A

Rm x Rh	Ref.	PN	Pack	U/	€
1/2" x 3/8"	RFV012038	16	10	500	1,59
3/4" x 3/8"	RFV034038	16	10	400	1,76
3/4" x 1/2"	RFV034012	16	10	320	1,71
1" x 3/8"	RFV100038	16	10	240	2,08
1" x 1/2"	RFV100012	16	10	200	1,97
1" x 3/4"	RFV100034	16	10	200	1,97
1 1/4" x 1/2"	RFV114012	16	10	100	2,48
1 1/4" x 3/4"	RFV114034	16	10	80	2,48
1 1/4" x 1"	RFV114100	16	10	80	2,41
1 1/2" x 1/2"	RFV112012	16	10	80	2,80
1 1/2" x 3/4"	RFV112034	16	10	80	2,82
1 1/2" x 1"	RFV112100	16	10	80	2,79
1 1/2" x 1 1/4"	RFV112114	16	10	80	2,79
2" x 3/4"	RFV200034	16	-	50	4,18
2" x 1"	RFV200100	16	-	40	4,18
2" x 1 1/4"	RFV200114	16	-	40	4,24
2" x 1 1/2"	RFV200112	16	-	40	4,11
2 1/2" x 2"	RFV212200	16	-	36	5,58
3" x 2"	RFV300200	16	-	20	6,96
3" x 2 1/2"	RFV300212	16	-	20	9,66
4" x 3"	RFV400300	16	-	8	22,22

Reducción roscada.

M-H rosca.

**NRFV**

A

Rm x Rm	Ref.	PN	Pack	U/📦	€
¾" x ½"	NRFV034012	16	10	300	1,22
1" x ¾"	NRFV100034	16	10	200	1,58
1¼" x 1"	NRFV114100	16	10	120	1,95
1½" x 1¼"	NRFV112114	16	10	80	2,38
2" x 1½"	NRFV200112	16	-	40	2,99
2½" x 2"	NRFV212200	16	-	24	5,58
3" x 2½"	NRFV300212	16	-	16	9,02
4" x 3"	NRFV400300	16	-	8	20,75

Machón reducido roscado.

M-M roscar.**IFFV**

A

Rh x Rm	Ref.	PN	Pack	U/📦	€
¾" x ½"	IFFV034012	16	10	280	1,73
1" x ½"	IFFV100012	16	10	140	7,02
1" x ¾"	IFFV100034	16	10	140	2,02
1¼" x 1"	IFFV114100	16	10	80	2,40
1½" x 1¼"	IFFV112114	16	10	40	2,89
2" x 1½"	IFFV200112	16	-	30	3,87
2½" x 2"	IFFV212200	16	-	20	25,61
3" x 2½"	IFFV300212	16	-	16	15,17
4" x 3"	IFFV400300	16	-	8	74,83

Reducción roscada.

H-M roscar.**NRIV**

A

d x Rm	Ref.	Pack	U/📦	€
25 x 1"	NRIV025100	10	120	4,35
32 x 1¼"	NRIV032114	10	60	5,63

Adaptador M-M.

M encolar - roscar.**JFV**

A

Rh	Ref.	PN	Pack	U/📦	€
½"	JFV012	16	25	1.000	8,39
¾"	JFV034	16	25	750	8,93
1"	JFV100	16	25	400	9,78
1¼"	JFV114	16	10	300	10,74
1½"	JFV112	16	10	200	Consultar
2"	JFV200	16	10	120	Consultar

Tuerca fina.

H roscar. Para adaptador depósito LIV y LIFV.



BIV

d	Ref.	PN	Pack	U/☒	A € EPDM
16	BIV016E	16	10	300	2,65
20	BIV020E	16	10	180	2,62
25	BIV025E	16	10	100	3,01
32	BIV032E	16	10	70	4,27
40	BIV040E	16	10	40	5,13
50	BIV050E	16	10	90	6,27
63	BIV063E	16	5	45	9,16
75	BIV075E	10	-	28	26,61
90	BIV090E	10	-	22	35,22
110	BIV110E	10	-	12	51,52

Unión 3 piezas encolar.
H-H encolar. Junta en EPDM.

Para recambios consultar
el apartado "Recambios"
de esta misma tarifa



BIFV

d x Rh	Ref.	PN	Pack	U/☒	A € EPDM
16 x 3/8"	BIFV016038E	16	10	300	3,00
20 x 1/2"	BIFV020012E	16	10	180	3,05
25 x 3/4"	BIFV025034E	16	10	100	3,59
32 x 1"	BIFV032100E	16	10	60	4,83
40 x 1 1/4"	BIFV040114E	16	10	40	6,06
50 x 1 1/2"	BIFV050112E	16	10	90	7,26
63 x 2"	BIFV063200E	16	5	60	10,57
75 x 2 1/2"	BIFV075212E	10	-	28	29,54
90 x 3"	BIFV090300E	10	-	22	37,72
110 x 4"	BIFV110400E	10	-	12	59,93

Unión 3 piezas mixto.
H-H encolar - rosacar. Junta en EPDM.

Para recambios consultar
el apartado "Recambios"
de esta misma tarifa



BIRV

d x Rm	Ref.	PN	Pack	U/☒	A € EPDM
20 x 1/2"*	BIRV020012E	16	-	25	3,82
25 x 3/4"*	BIRV025034E	16	-	30	4,27
32 x 1"*	BIRV032100E	16	-	50	5,50
40 x 1 1/4"*	BIRV040114E	16	-	36	6,38
50 x 1 1/2"	BIRV050112E	16	10	80	7,61
50 x 2"	BIRV050200E	16	10	80	11,51
63 x 2"	BIRV063200E	16	5	35	10,53
75 x 2 1/2"*	BIRV075212E	16	-	12	32,27
90 x 3"*	BIRV090300E	16	-	18	42,24

Unión 3 piezas mixto.
H-H encolar - rosacar. Junta en EPDM.

Para recambios consultar
el apartado "Recambios"
de esta misma tarifa



BFV

Rh	Ref.	PN	Pack	U/☒	A € EPDM
3/8"	BFV038E	16	10	300	3,43
1/2"	BFV012E	16	10	180	3,67
3/4"	BFV034E	16	10	100	4,34
1"	BFV100E	16	10	60	5,78
1 1/4"	BFV114E	16	10	40	7,27
1 1/2"	BFV112E	16	10	90	8,56
2"	BFV200E	16	5	60	12,16
2 1/2"*	BFV212E	10	-	15	53,31
3"*	BFV300E	6	-	12	57,23
4"*	BFV400E	6	-	12	65,15

Unión 3 piezas rosado.
H-H rosacar. Junta en EPDM.

Para recambios consultar
el apartado "Recambios"
de esta misma tarifa



BIFOV

d x Rh	Ref.	PN	Pack	U/☒	A € EPDM
16 x 3/8"	BIFOV016038E	16	50	100	11,02
20 x 1/2"	BIFOV020012E	16	40	80	14,29
25 x 3/4"	BIFOV025034E	16	20	40	18,21
32 x 1"	BIFOV032100E	16	14	28	22,91
40 x 1 1/4"	BIFOV040114E	16	8	16	32,23
50 x 1 1/2"	BIFOV050112E	16	4	8	40,24
63 x 2"	BIFOV063200E	16	-	12	65,48

Unión 3 piezas mixto PVC-U / Latón.
H-H encolar - rosacar latón. Junta en EPDM.

Para recambios consultar
el apartado "Recambios"
de esta misma tarifa



BIOV

d x Rm	Ref.	PN	Pack	U/☒	A € EPDM
16 x 3/8"	BIOV016038E	16	50	100	13,24
20 x 1/2"	BIOV020012E	16	35	70	15,44
25 x 3/4"	BIOV025034E	16	15	30	20,20
32 x 1"	BIOV032100E	16	12	24	25,96
40 x 1 1/4"	BIOV040114E	16	8	16	37,69
50 x 1 1/2"	BIOV050112E	16	4	8	44,93
63 x 2"	BIOV063200E	16	-	10	77,67

Unión 3 piezas mixto PVC-U / Latón.
H-H encolar - rosacar latón. Junta en EPDM.

Para recambios consultar
el apartado "Recambios"
de esta misma tarifa

**BIFXV**

d x Rh	Ref. EPDM	PN	Pack	€ EPDM	A € FKM
16 x 3/8"	BIFXV016038E	16	50	38,45	40,81
20 x 1/2"	BIFXV020012E	16	40	41,08	43,54
25 x 3/4"	BIFXV025034E	16	20	47,09	49,35
32 x 1"	BIFXV032100E	16	14	54,28	57,21
40 x 1 1/4"	BIFXV040114E	16	8	76,93	79,66
50 x 1 1/2"	BIFXV050112E	16	4	84,80	89,74
63 x 2"	BIFXV063200E	16	-	107,85	112,84

Unión 3 piezas mixto
PVC-U / Inox A316L.

H-H encolar - rosacar inox.
Junta en EPDM o FKM.

Código en FKM termina en "F"
en lugar de "E"

Para recambios consultar
el apartado "Recambios"
de esta misma tarifa

**BIRXV**

d x Rm	Ref. EPDM	PN	Pack	€ EPDM	A € FKM
16 x 3/8"	BIRXV016038E	16	50	41,26	43,38
20 x 1/2"	BIRXV020012E	16	35	43,71	46,00
25 x 3/4"	BIRXV025034E	16	15	49,18	51,31
32 x 1"	BIRXV032100E	16	12	55,48	58,75
40 x 1 1/4"	BIRXV040114E	16	8	76,95	82,68
50 x 1 1/2"	BIRXV050112E	16	4	91,41	95,88
63 x 2"	BIRXV063200E	16	-	126,23	137,79

Unión 3 piezas mixto
PVC-U / Inox A316L.

H-M encolar - rosacar inox.
Junta en EPDM o FKM.

Código en FKM termina en "F"
en lugar de "E"

Para recambios consultar
el apartado "Recambios"
de esta misma tarifa

**ADV**

Rh x P1 x P2	Ref.	PN	Pack	U/ 	A € EPDM
1/2" x 12 x 14	ADV012012014	16	5	300	2,33
3/4" x 16 x 18	ADV034016018	16	5	200	2,85
1" x 20 x 22	ADV100020022	16	5	160	3,24
1 1/4" x 25 x 27	ADV114025027	16	5	80	3,70
1 1/2" x 30 x 32	ADV112030032	16	5	50	4,80
2" x 40 x 42	ADV200040042	16	5	30	4,68
2" x 50 x 52	ADV200050052	16	5	25	5,77
2 1/4" x 50 x 52	ADV214050052	16	5	20	14,01
2 3/4" x 60 x 64	ADV234060064	16	3	21	6,90

Espiga con tuerca.

H-M rosacar - presión. Junta en EPDM

**AIV**

d x P2 x P1	Ref.	PN	Pack	U/ 	A €
12 x 14 x 12	AIV012014012	16	10	1.000	0,84
16 x 18 x 16	AIV016018016	16	10	600	0,85
20 x 22 x 20	AIV020022020	16	10	500	1,06
25 x 27 x 25	AIV025027025	16	10	200	1,29
32 x 32 x 30	AIV032032030	16	10	100	1,64
40 x 42 x 40	AIV040042040	16	5	100	1,93
50 x 52 x 50	AIV050052050	16	5	40	2,75
63 x 64 x 60	AIV063064060	16	-	40	3,47

Espiga encolar macho.

M-M encolar - presión.

**ADV-J**

R x P1 x P2	Ref.	A € EPDM
1/2" x 12 x 14	GP1210E	0,50
3/4" x 16 x 18	GP0193E	0,56
1" x 20 x 22	GP1212E	0,56
1 1/4" x 25 x 27	QH VX025E	0,92
1 1/2" x 30 x 32	GP0196E	0,76
2" x 40 x 42	GP0197E	1,11
2" x 50 x 52	GP0197E	1,11
2 1/4" x 50 x 52	GP0198E	1,43
2 3/4" x 60 x 64	QH VX050E	1,91
3 3/4" x 60 x 64	GPO0199E	2,03

Junta plana EPDM

Para espiga con tuerca ADV

**AFV**

Rm x P1 x P2	Ref.	PN	Pack	U/ 	A €
1/4" x 12 x 14	AFV014012014	16	10	1.000	0,85
3/8" x 16 x 18	AFV038016018	16	10	600	0,82
1/2" x 20 x 22	AFV012020022	16	10	300	1,06
3/4" x 25 x 27	AFV034025027	16	10	160	1,26
1" x 30 x 32	AFV100030032	16	10	100	1,64
1 1/4" x 40 x 42	AFV114040042	16	5	50	1,95
1 1/2" x 50 x 52	AFV112050052	16	5	30	2,80
2" x 60 x 64	AFV200060064	16	-	20	3,52

Espiga rosca macho.

M-M rosacar - presión.



PINZA*

A

d	Ref.	Pack	€
16**	PINZA016	10	0,72
20**	PINZA020	10	0,67
25**	PINZA025	10	0,81
32**	PINZA032	10	0,94
40	PINZA040	10	1,89
50	PINZA050	10	2,38
63	PINZA063	10	2,78
75	PINZA075	10	3,67
90	PINZA090	10	4,84
110	PINZA110	10	5,65

Abrazadera para tubería PP gris.
 Marca *ASTORE*.

** En estos diámetros
 sin cierre superior

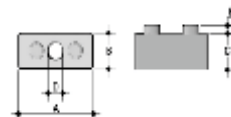

DSM

A

d	Ref.	A	B	C	D	E	€
32	DSM032	33	16	14	8	4	1,29
40	DSM040	41	17	17	8	4	1,76
50	DSM050	51	18	17	8	4	2,37
63	DSM063	64	19	22,5	8	4	3,12
75	DSM075	76	20	34,5	8	4	4,31

Soporte en PP para abrazadera ZIKM



COBRA*

A

d	Ref.	Pack	€
12**	COBRA012	10	0,43
16**	COBRA016	10	0,43
20**	COBRA020	10	0,86
25**	COBRA025	10	1,08
32**	COBRA032	10	1,95
40	COBRA040	10	2,60
50	COBRA050	10	2,81
63	COBRA063	10	4,34
75	COBRA075	10	8,91
90	COBRA090	10	10,62
110	COBRA110	10	14,74
125	COBRA125	10	34,33
140	COBRA140	-	31,51
160	COBRA160	-	39,75

Abrazadera para tubería PP negro.
 Marca *DURAPIPE*.

** En estos diámetros
 sin cierre superior



ZIKM

A

d	Ref.	Pack	U/☐	€
16	ZIKM016	10	800	1,84
20	ZIKM020	10	600	1,97
25	ZIKM025	10	160	2,03
32	ZIKM032	10	240	2,42
40	ZIKM040	10	160	2,97
50	ZIKM050	10	100	3,42
63	ZIKM063	10	80	4,22
75	ZIKM075	-	80	5,98
90	ZIKM090	-	40	7,30
110	ZIKM110	-	30	10,18
125	ZIKM125	-	20	13,81
140	ZIKM140	-	20	14,43
160	ZIKM160	-	10	16,59
180	ZIKM180	-	10	15,17

Abrazadera para tubería PP gris.

**PEG***

A

litros	Ref.	Descripción	€
1	PEG100P	Con pincel	27,43
0,5	PEG012P	Con pincel	15,62
1	PEG100T	Tapa a presión	22,72
0,5	PEG012T	Tapa a presión	12,83

Pegamento PVC.

**PEG***

A

Ref.	Largo x Ancho x Grueso	€
TEF150	50 m. x 19 mm. x 0,15 mm.	7,90

Teflón.

**DIS***

A

litros	Ref.	€
1	DIS100	17,60
0,5	DIS012	12,34

Disolvente PVC.

Válvulas de bola 2 y 3 vías

Válvulas de mariposa

Válvulas y grifos de membrana

Válvulas de retención

Filtros inclinados

Accesorios para válvulas manuales

Válvulas manuales en PVC-U presión

INDUSTRIA



Bloqueo de las tuercas

Para asegurar la PN y aflojes por vibraciones elevadas



Válvulas de bola

Tapón portaetiqueta

Tapón para personalizar o señalar la válvula.

PVC-U

Bidireccional.
Sin dirección de montaje.
Sin flecha en el cuerpo

Plena libertad y seguridad a la hora del montaje. Se pueden instalar sin necesidad de seguir la dirección de montaje. Mucho más fácil y sin riesgo de que se desmonte o bloquee la bola por la presión del fluido al desmontar el extremo que da acceso a la misma. Tampoco se bloquea la bola si nos excedemos al apretar los extremos. Por tanto el eje no sufre ni se rompe.



Tapón de protección transparente con porta etiqueta para el sistema de Labelling Easyfit (opcional)

Optional transparent service plug with tag holder for Easyfit Labelling system



Tapón de protección estándar
Grey standard service plug

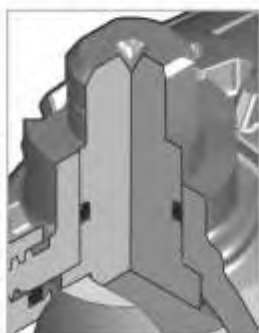

Eje y esfera de tipo flotante de alta finura superficial

High finishing stem and floating ball



Casquillo roscado de seguridad

Safe blocked carrier



Montaje radial según norma EN 1452 "short"

True union installation according to EN 1452 "short"



Gama VEE

Maneta multifunción Easyfit
Easyfit multifunctional handle



Control rotación tuercas
Union nut rotation control



Regulación casquillo estanco y bola
Ball seat carrier adjustment



Regulación del apriete
de las tuercas Easyfit
Easyfit union nut gear
tightening



Cuerpo de la válvula PN16
Certificado 97/23/CE

Valve body PN16
97/23/CE Certified



Sistema de etiquetado:

sistema completo de etiquetado que identifica la válvula según necesidades específicas.

Labelling System:

complete tagging system that allows the identification of the valve according to specific needs.



Rendimiento y seguridad:

válvula ligera y compacta con cuerpo PN16 en PVC-U K62 o PVC-C Corzan y doble junta tórica en el eje de la válvula. El acabado de gran calidad de la bola, el asiento de bola y el disco anti-fricción en PTFE situado en la base del eje minimizan las fricciones logrando un excelente funcionamiento de par de torsión.



Performance and safety: light and compact valve with PN16 body in PVC-U K62 or PVC-C Corzan™ and double O-ring seal on the valve stem. The high surface finished ball, the PTFE ball seat and the PTFE anti-friction disc located at the base of the stem minimize the frictions achieving excellent operating torque.

Performance and safety:

light and compact valve with PN16 body in PVC-U K62 or PVC-C Corzan™ and double O-ring seal on the valve stem. The high surface finished ball, the PTFE ball

Cerradura a prueba de manipulaciones:

la válvula está equipada con un sistema simple que evita la rotación de la maneta tanto de apertura como de cierre mediante un candado.

Fácil accionamiento:

el cuerpo de la válvula tiene una estructura integrada para fijar el kit de actuación PowerQuick, específico para la instalación de actuadores neumáticos y eléctricos.

Easy

actuation:

the valve body has an integrated structure for anchoring the special PowerQuick module, dedicated to the installation of pneumatic and electric actuators.

Tamper-proof lock:

the valve is equipped with a simple system that avoid the handle rotation both for opening and closing operations inputting a padlock.





Gama VXE

DN 65/100

Maneta multifunctional Easyfit
Easyfit multifunctional handle

Maneta multifunción Easyfit de rápida extracción:

para usar la maneta como herramienta multifuncional para apretar las tuercas de unión y ajustar el soporte de asiento de bola se puede extraer del dado con una simple maniobra permaneciendo firme al eje que se está maniobrando.



Easyfit Quick-release multifunctional handle:

the handle, to be used as multifunction tool for union nuts tightening and ball seat carrier adjustment can be removed with a simple operation from the hub which remains firmly coupled to the maneuvering stem.



Bisel giratorio con la maneta multifuncional Easyfit:

el uso del gancho alojado en el interior de la maneta permite crear una llave para el ajuste de las tuercas de unión que asegura un acoplamiento seguro y sólido.



Ajuste del casquillo de la bola de apoyo con la maneta multifuncional Easyfit.

Ball seat carrier adjustment with Easyfit multifunctional handle.



Union nut tightening with Easyfit multifunctional handle:

the use of the hooked insert housed inside the handle allows to realize a key for the union nuts rotation that ensures a secure and solid engagement.



Maneta multifunción
Multi functional handle

Kit de montaje para actuadores
Mounting flange



Soporte de fijación
Bracketing



Gama VKD

Válvula industrial



Conexión eje y bola
Stem-ball connection

Soporte del asiento de la bola
Safe blocked carrier

Dual Block
Dual Block



Cuerpo
Body





INDUSTRIA

Válvulas manuales de PVC-U presión

Válvulas de bola 2 vías

**VEEIV**

d	Ref.	DN	PN	U/	C € EPDM
16	VEEIV016E	10	16	60	13,10
20	VEEIV020E	15	16	60	13,10
25	VEEIV025E	20	16	40	14,47
32	VEEIV032E	25	16	25	18,99
40	VEEIV040E	32	16	14	22,13
50	VEEIV050E	40	16	15	30,24
63	VEEIV063E	50	16	8	41,17

Válvula de bola maneta azul.

H-H encolar. Junta EPDM - Asiento PE. Bidireccional.

**VEEFV**

Rh	Ref.	DN	PN	U/	C € EPDM
3/8"	VEEFV038E	10	16	60	13,75
1/2"	VEEFV012E	15	16	60	13,75
3/4"	VEEFV034E	20	16	40	15,16
1"	VEEFV100E	25	16	25	20,12
1 1/4"	VEEFV114E	32	16	14	23,61
1 1/2"	VEEFV112E	40	16	15	32,23
2"	VEEFV200E	50	16	8	43,78

Válvula de bola maneta azul.

H-H roscar. Junta EPDM - Asiento PE. Bidireccional.

**VEEIV**

d	Ref.	DN	PN	U/	C € EPDM
75	VEEIV075E	65	16	2	122,30
90	VEEIV090E	80	16	2	166,47
110	VEEIV110E	100	16	1	297,57

Válvula de bola maneta azul.

H-H encolar. Junta EPDM - Asiento PE. Bidireccional.

**VEEFV**

Rh	Ref.	DN	PN	U/	C € EPDM
2 1/2"	VEEFV212E	65	16	2	128,52
3"	VEEFV300E	80	16	2	173,04
4"	VEEFV400E	100	16	1	313,98

Válvula de bola maneta azul.

H-H roscar. Junta EPDM - Asiento PE. Bidireccional.

**VEEBEV**

d	Ref.	DN	PN	U/	C € EPDM
20	VEEBEV020E	15	16	-	24,83
25	VEEBEV025E	20	16	-	26,37
32	VEEBEV032E	25	16	-	31,23
40	VEEBEV040E	32	16	-	41,00
50	VEEBEV050E	40	16	-	52,96
63	VEEBEV063E	50	16	-	73,31

Válvula de bola maneta azul.

Long spigot PE100 SDR11.

Junta EPDM - Asiento PE. Bidireccional.

Terminales PE
se entregan aparte
incluidos en el precio**VEEBEV**

d	Ref.	DN	PN	U/	C € EPDM
75	VEEBEV075E	65	16	2	215,32
90	VEEBEV090E	80	16	2	287,16
110	VEEBEV110E	100	16	1	438,17

Válvula de bola maneta azul.

Long spigot PE100 SDR11.

Junta EPDM - Asiento PE. Bidireccional.

Terminales PE
se entregan aparte
incluidos en el precio

Para recambios de las válvulas consultar el último apartado "Recambios" de esta misma tarifa.

**VXEIV**

d	Ref. EPDM	DN	PN	U/	C	
					€ EPDM	€ FKM
16	VXEIV016E	10	16	30	16,80	20,11
20	VXEIV020E	15	16	30	16,87	20,18
25	VXEIV025E	20	16	30	19,94	24,15
32	VXEIV032E	25	16	20	23,44	28,36
40	VXEIV040E	32	16	14	30,49	36,05
50	VXEIV050E	40	16	6	37,51	44,18
63	VXEIV063E	50	16	6	49,95	64,01

Válvula de bola maneta naranja. Código en FKM termina en "F" en lugar de "E"
H-H encolar. Asiento PTFE (teflón). Bidireccional.

**VXEIV**

Rh	Ref. EPDM	DN	PN	U/	C	
					€ EPDM	€ FKM
3/8"	VXEIV038E	10	16	30	18,48	22,05
1/2"	VXEIV012E	15	16	30	18,55	22,05
3/4"	VXEIV034E	20	16	30	21,89	26,15
1"	VXEIV100E	25	16	20	26,27	31,16
1 1/4"	VXEIV114E	32	16	14	34,13	39,68
1 1/2"	VXEIV112E	40	16	6	41,27	47,90
2"	VXEIV200E	50	16	6	60,96	74,97

Válvula de bola maneta naranja. Código en FKM termina en "F" en lugar de "E"
H-H roscar. Asiento PTFE (teflón). Bidireccional.

**VXEIV**

d	Ref. EPDM	DN	PN	C	
				€ EPDM	€ FKM
75	VXEIV075E	65	16	132,33	145,58
90	VXEIV090E	80	16	180,19	198,20
110	VXEIV110E	100	16	370,15	407,15

Válvula de bola maneta naranja. Código en FKM termina en "F" en lugar de "E"
H-H encolar. Asiento PTFE (teflón). Bidireccional.

**VXEIV**

Rh	Ref. EPDM	DN	PN	C	
				€ EPDM	€ FKM
2 1/2"	VXEIV212E	65	16	148,55	287,45
3"	VXEIV300E	80	16	196,79	358,03
4"	VXEIV400E	100	16	413,46	455,82

Válvula de bola maneta naranja. Código en FKM termina en "F" en lugar de "E"
H-H roscar. Asiento PTFE (teflón). Bidireccional.

**VXEIV**

d	Ref. EPDM	DN	PN	C	
				€ EPDM	€ FKM
20	VXEIV020E	15	16	28,57	32,08
25	VXEIV025E	20	16	32,08	36,32
32	VXEIV032E	25	16	35,89	40,80
40	VXEIV040E	32	16	49,74	55,33
50	VXEIV050E	40	16	60,54	67,24
63	VXEIV063E	50	16	82,56	96,62

Válvula de bola maneta naranja. Código en FKM termina en "F" en lugar de "E"
Long spigot PE100 SDR11. Terminales PE se entregan aparte incluidos en el precio
Asiento PTFE (teflón). Bidireccional.

**VXEIV**

d	Ref. EPDM	DN	PN	C	
				€ EPDM	€ FKM
75	VXEIV075E	65	16	219,54	232,61
90	VXEIV090E	80	16	293,18	310,91
110	VXEIV110E	100	16	495,20	531,63

Válvula de bola maneta naranja. Código en FKM termina en "F" en lugar de "E"
Long spigot PE100 SDR11. Terminales PE se entregan aparte incluidos en el precio
Asiento PTFE (teflón). Bidireccional.

Para recambios de las válvulas consultar el último apartado "Recambios" de esta misma tarifa.

**VPE***

Rh x d	Ref. EPDM	PN	U 	C € EPDM
3/8" x 16	VPE038016	16	120	12,56
1/2" x 20	VPE012020	16	100	12,56
3/4" x 25	VPE034025	16	60	14,46
1" x 32	VPE100032	16	40	15,98
1 1/4" x 40	VPE114040	16	20	24,68
1 1/2" x 50	VPE112050	16	15	28,37
2" x 63	VPE200063	16	8	42,81

Válvula de bola.

PVC roscar hembra. Enlace PE H.

Disponible la versión para encolar al mismo precio

**VKDFV**

Rh	Ref. EPDM	DN	PN	€ EPDM	D € FKM
3/8"	VKDFV038E	10	16	41,21	48,89
1/2"	VKDFV012E	15	16	43,18	50,67
3/4"	VKDFV034E	20	16	51,68	58,77
1"	VKDFV100E	25	16	63,45	78,34
1 1/4"	VKDFV114E	32	16	80,60	92,37
1 1/2"	VKDFV112E	40	16	105,67	120,44
2"	VKDFV200E	50	16	133,10	163,94

Válvula de bola DUAL BLOCK®.

H-H roscar. Asiento PTFE (teflón).

Bidireccional.

Código en FKM termina en "F" en lugar de "E"

**VKDIV**

d	Ref. EPDM	DN	PN	€ EPDM	D € FKM
16	VKDIV016E	10	16	38,22	46,34
20	VKDIV020E	15	16	39,78	47,59
25	VKDIV025E	20	16	47,07	57,06
32	VKDIV032E	25	16	58,62	70,88
40	VKDIV040E	32	16	73,00	86,33
50	VKDIV050E	40	16	94,09	110,77
63	VKDIV063E	50	16	117,16	150,09

Válvula de bola DUAL BLOCK®.

H-H encolar. Asiento PTFE (teflón).

Bidireccional.

Código en FKM termina en "F" en lugar de "E"

**VKDFV**

Rh	Ref. EPDM	DN	PN	€ EPDM	D € FKM
2 1/2"	VKDFV212E	65	16	381,15	450,71
3"	VKDFV300E	80	16	485,59	570,43
4"	VKDFV400E	100	16	546,09	663,15

Válvula de bola DUAL BLOCK®.

H-H roscar. Asiento PTFE (teflón).

Bidireccional.

Código en FKM termina en "F" en lugar de "E"

**VKDIV**

d	Ref. EPDM	DN	PN	€ EPDM	D € FKM
75	VKDIV075E	65	16	352,92	422,47
90	VKDIV090E	80	16	449,63	534,45
110	VKDIV110E	100	16	505,63	622,67

Válvula de bola DUAL BLOCK®.

H-H encolar. Asiento PTFE (teflón).

Bidireccional.

Código en FKM termina en "F" en lugar de "E"



Medida	Ref.	DN	PN	€	M1
140	52322	125	10	592,11	

Válvula de bola PASO TOTAL con bridas.

Sugerencia tomillería M6x100

Para recambios de las válvulas consultar el último apartado "Recambios" de esta misma tarifa.

**VKDDV**

d	Ref. EPDM	DN	PN	D	
				€ EPDM	€ FKM
16	VKDDV016E	10	16	38,22	46,34
20	VKDDV020E	15	16	39,78	47,59
25	VKDDV025E	20	16	47,07	57,06
32	VKDDV032E	25	16	58,62	70,88
40	VKDDV040E	32	16	73,00	86,33
50	VKDDV050E	40	16	94,09	110,77
63	VKDDV063E	50	16	117,16	150,09

Válvula de bola DUAL BLOCK®.

M-M encolar. Asiento PTFE (teflón).

Bidireccional.

Código en FKM termina en "F"
en lugar de "E"**VKDBEV**

d	Ref. EPDM	DN	PN	D	
				€ EPDM	€ FKM
20	VKDBEV020E	15	16	48,01	65,78
25	VKDBEV025E	20	16	48,27	62,76
32	VKDBEV032E	25	16	55,70	74,84
40	VKDBEV040E	32	16	72,15	94,45
50	VKDBEV050E	40	16	89,07	116,20
63	VKDBEV063E	50	16	116,90	155,68

Válvula de bola DUAL BLOCK®.

Long spigot PE100 SDR11.

Asiento PTFE (teflón). Bidireccional.

Código en FKM termina en "F"
en lugar de "E"**VKDDV**

d	Ref. EPDM	DN	PN	D	
				€ EPDM	€ FKM
75	VKDDV075E	65	16	352,92	422,47
90	VKDDV090E	80	16	449,63	534,45
110	VKDDV110E	100	16	505,63	622,67

Válvula de bola DUAL BLOCK®.

M-M encolar. Asiento PTFE (teflón).

Bidireccional.

Código en FKM termina en "F"
en lugar de "E"**VKDBEV**

d	Ref. EPDM	DN	PN	D	
				€ EPDM	€ FKM
75	VKDBEV075E	65	16	388,21	457,78
90	VKDBEV090E	80	16	494,59	579,43
110	VKDBEV110E	100	16	556,18	673,24

Válvula de bola DUAL BLOCK®.

Long spigot PE100 SDR11.

Asiento PTFE (teflón). Bidireccional.

Código en FKM termina en "F"
en lugar de "E"**VKROV**

d	Ref. EPDM	DN	PN	D	
				€ EPDM	€ FKM
20	VKROV020E	15	16	190,30	190,30
25	VKROV025E	20	16	213,93	213,93
32	VKROV032E	25	16	252,32	252,32
40	VKROV040E	32	16	277,81	277,80
50	VKROV050E	40	16	352,48	352,48
63	VKROV063E	50	16	384,45	384,45

Válvula de bola REGULACIÓN
DUAL BLOCK®.

Con bridas DIN 2501.

Asiento PTFE (teflón). Bidireccional.

Código en FKM termina en "F"
en lugar de "E"**VKROAV**

d	Ref. EPDM	DN	PN	D	
				€ EPDM	€ FKM
½"	VKROAV012E	15	16	190,30	190,30
¾"	VKROAV034E	20	16	213,93	213,93
1"	VKROAV100E	25	16	252,32	252,32
1¼"	VKROAV114E	32	16	277,81	277,80
1½"	VKROAV112E	40	16	352,48	352,48
2"	VKROAV200E	50	16	384,45	384,45

Válvula de bola REGULACIÓN
DUAL BLOCK®.

Con bridas ANSI 150 lbs..

Asiento PTFE (teflón). Bidireccional.

Código en FKM termina en "F"
en lugar de "E"

Para recambios de las válvulas consultar el último apartado "Recambios" de esta misma tarifa.

**VKDOV**

d	Ref. EPDM	DN	PN	D	
				€ EPDM	€ FKM
20	VKDOV020E	15	16	113,31	117,53
25	VKDOV025E	20	16	132,83	137,74
32	VKDOV032E	25	16	186,93	148,28
40	VKDOV040E	32	16	175,86	183,52
50	VKDOV050E	40	16	195,37	211,36
63	VKDOV063E	50	16	225,61	248,76

Válvula de bola DUAL BLOCK®.
Con brida loca. Asiento PTFE (teflón).
Bidireccional.

Código en FKM termina en "F"
en lugar de "E"
Versión con bridas ANSI 150 lbs
al mismo precio

**VKRIV**

d	Ref. EPDM	DN	PN	D	
				€ EPDM	€ FKM
16	VKRIV016E	10	16	155,88	163,99
20	VKRIV020E	15	16	157,43	165,25
25	VKRIV025E	20	16	176,86	186,85
32	VKRIV032E	25	16	212,34	224,56
40	VKRIV040E	32	16	224,26	237,61
50	VKRIV050E	40	16	293,51	310,19
63	VKRIV063E	50	16	305,69	338,63

Válvula de bola REGULACIÓN
DUAL BLOCK®.

Código en FKM termina en "F"
en lugar de "E"

H-H encolar. Asiento PTFE (teflón).
Bidireccional.

**VKDOV**

d	Ref. EPDM	DN	PN	D	
				€ EPDM	€ FKM
75	VKDOV075E	65	16	537,87	577,28
90	VKDOV090E	80	16	677,24	749,41
110	VKDOV110E	100	16	851,79	944,59

Válvula de bola DUAL BLOCK®.
Con brida loca. Asiento PTFE (teflón).
Bidireccional. DIN y ANSI 150 Lbs.

Código en FKM termina en "F"
en lugar de "E"

**VKRFV**

Rh	Ref. EPDM	DN	PN	D	
				€ EPDM	€ FKM
3/8"	VKRFV038E	10	16	158,89	158,89
1/2"	VKRFV012E	15	16	160,84	160,85
3/4"	VKRFV034E	20	16	181,47	181,48
1"	VKRFV100E	25	16	217,12	217,12
1 1/4"	VKRFV114E	32	16	231,90	231,89
1 1/2"	VKRFV112E	40	16	305,08	305,07
2"	VKRFV200E	50	16	321,65	321,66

Válvula de bola REGULACIÓN
DUAL BLOCK®.

Código en FKM termina en "F"
en lugar de "E"

H-H roscar. Asiento PTFE (teflón).
Bidireccional.

**VKRDV**

d	Ref. EPDM	DN	PN	D	
				€ EPDM	€ FKM
16	VKRDV016E	10	16	155,88	155,88
20	VKRDV020E	15	16	157,44	157,44
25	VKRDV025E	20	16	176,86	176,86
32	VKRDV032E	25	16	212,34	212,34
40	VKRDV040E	32	16	224,26	224,26
50	VKRDV050E	40	16	293,51	293,51
63	VKRDV063E	50	16	305,69	305,70

Válvula de bola REGULACIÓN
DUAL BLOCK®.

M-M encolar. Asiento PTFE (teflón).
Bidireccional.

Código en FKM termina en "F"
en lugar de "E"

**VKRBEV**

d	Ref. EPDM	DN	PN	D	
				€ EPDM	€ FKM
20	VKRBEV020E	15	16	165,67	165,67
25	VKRBEV025E	20	16	178,06	178,06
32	VKRBEV032E	25	16	209,38	209,38
40	VKRBEV040E	32	16	223,44	223,44
50	VKRBEV050E	40	16	288,48	288,48
63	VKRBEV063E	50	16	305,45	305,45

Válvula de bola REGULACIÓN
DUAL BLOCK®.

Long spigot PE100 SDR11.
Asiento PTFE (teflón). Bidireccional.

Código en FKM termina en "F"
en lugar de "E"

Para recambios de las válvulas consultar el último apartado "Recambios" de esta misma tarifa.

**TKDIV**

d	Ref. EPDM	DN	PN	I	
				€ EPDM	€ FKM
16	TKDIV016E	10	16	84,09	102,67
20	TKDIV020E	15	16	85,85	104,77
25	TKDIV025E	20	16	99,34	123,40
32	TKDIV032E	25	16	123,14	152,97
40	TKDIV040E	32	16	148,55	189,37
50	TKDIV050E	40	16	179,54	242,35
63	TKDIV063E	50	16	226,53	305,80

Válvula de bola 3 vías
DUAL BLOCK®. PASO T.

H-H-H encolar. Asiento PTFE (teflón).

Código en FKM termina en "F"
en lugar de "E"

**LKDIV**

d	Ref. EPDM	DN	PN	I	
				€ EPDM	€ FKM
16	LKDIV016E	10	16	92,50	104,54
20	LKDIV020E	15	16	94,41	106,69
25	LKDIV025E	20	16	109,32	125,66
32	LKDIV032E	25	16	135,50	155,80
40	LKDIV040E	32	16	163,46	192,90
50	LKDIV050E	40	16	197,48	246,84
63	LKDIV063E	50	16	249,17	311,46

Válvula de bola 3 vías
DUAL BLOCK®. PASO L.

H-H-H encolar. Asiento PTFE (teflón).

Código en FKM termina en "F"
en lugar de "E"

**TKDFV**

Rh	Ref. EPDM	DN	PN	I	
				€ EPDM	€ FKM
3/8"	TKDFV038E	10	16	92,50	111,73
1/2"	TKDFV012E	15	16	94,41	114,01
3/4"	TKDFV034E	20	16	109,32	134,10
1"	TKDFV100E	25	16	135,50	166,25
1 1/4"	TKDFV114E	32	16	163,46	205,43
1 1/2"	TKDFV112E	40	16	197,48	261,79
2"	TKDFV200E	50	16	249,17	330,31

Válvula de bola 3 vías
DUAL BLOCK®. PASO T.

H-H-H roscar. Asiento PTFE (teflón).

Código en FKM termina en "F"
en lugar de "E"

**LKDFV**

Rh	Ref. EPDM	DN	PN	I	
				€ EPDM	€ FKM
3/8"	LKDFV038E	10	16	100,94	112,95
1/2"	LKDFV012E	15	16	102,99	115,28
3/4"	LKDFV034E	20	16	119,19	135,60
1"	LKDFV100E	25	16	147,78	168,09
1 1/4"	LKDFV114E	32	16	178,32	207,75
1 1/2"	LKDFV112E	40	16	215,44	264,80
2"	LKDFV200E	50	16	271,85	334,12

Válvula de bola 3 vías
DUAL BLOCK®. PASO L.

H-H-H roscar. Asiento PTFE (teflón).

Código en FKM termina en "F"
en lugar de "E"

**TKDDV**

d	Ref. EPDM	DN	PN	I	
				€ EPDM	€ FKM
20	TKDDV020E	15	16	85,85	104,77
25	TKDDV025E	20	16	99,34	123,40
32	TKDDV032E	25	16	123,14	152,97
40	TKDDV040E	32	16	148,55	189,37
50	TKDDV050E	40	16	179,54	242,35
63	TKDDV063E	50	16	226,53	305,80

Válvula de bola 3 vías
DUAL BLOCK®. PASO T.

M-M-M encolar. Asiento PTFE (teflón).

Código en FKM termina en "F"
en lugar de "E"

Para recambios de las válvulas consultar el último apartado "Recambios" de esta misma tarifa.



INDUSTRIA

Válvulas manuales de PVC-U presión

Válvulas de 3 vías

**LKDDV**

d	Ref. EPDM	DN	PN	I	
				€ EPDM	€ FKM
20	LKDDV020E	15	16	94,41	106,69
25	LKDDV025E	20	16	109,32	125,66
32	LKDDV032E	25	16	135,50	155,80
40	LKDDV040E	32	16	163,46	192,90
50	LKDDV050E	40	16	197,48	246,84
63	LKDDV063E	50	16	249,17	311,46

Válvula de bola 3 vías
DUAL BLOCK® . PASO L.

M-M-M encolar. Asiento PTFE (teflón).

Código en FKM termina en "F"
en lugar de "E"

SETFLOV

d DIN	d ANSI	Ref. DIN	I	
			€ DIN 2501	€ ANSI
20	½"	SETFLOV020	41,66	41,66
25	¾"	SETFLOV025	50,05	50,05
32	1"	SETFLOV032	53,54	53,54
40	1¼"	SETFLOV040	64,20	64,19
50	1½"	SETFLOV050	73,29	73,29
63	2"	SETFLOV063	79,39	79,39
75	2½"	SETFLOV075		146,05
90	3"	SETFLOV090		171,31
110	4"	SETFLOV110		206,68

Set embridado.

Compuesto por 1 brida, 1 anillo fijación y 1 tuerca.
Para Válvulas VKD / VKR / TKD / RVU / VRU / WVU.

d. 75-90-110,
es el mismo artículo
para DIN y ANSI

Para recambios de las válvulas consultar el último apartado "Recambios" de esta misma tarifa.



INDUSTRIA

Válvulas manuales de PVC-U presión

Válvulas de mariposa



FEOV/LM

d	Ref. EPDM	DN	€ EPDM	F € FKM
50	FEOVLM050E	40	114,05	209,38
63	FEOVLM063E	50	119,61	220,94
75	FEOVLM075E	65	124,01	223,62
90	FEOVLM090E	80	139,42	270,98
110	FEOVLM110E	100	160,39	331,98
125 (A1)	FEOVLM140E	125	184,72	433,67
140	FEOVLM140E	125	184,72	433,67
160	FEOVLM160E	150	227,36	623,35
200 (A1)	FEOVLM225E	200	365,77	878,48
225	FEOVLM225E	200	365,77	878,48
(B) 250 (1)	FEOVFM280E	250	1.084,45	-
280 (1)	FEOVFM280E	250	1.084,45	-
315 (1)	FEOVFM315E	300	1.347,94	-

Válvula de mariposa "WAFER".

Con maneta.

Código en FKM termina en "F" en lugar de "E"

(A1) A utilizar con portabridas especial QPV FK/FE no incluido. (1) Sin maneta
(B) A utilizar con tubo D250 SDR26 (PN10)



FEOV/RM

d	Ref. EPDM	DN	€ EPDM	F € FKM
75	FEOVRM075E	65	348,17	419,82
90	FEOVRM090E	80	362,20	453,33
110	FEOVRM110E	100	374,70	501,64
125 (A1)	FEOVRM140E	125	391,82	577,15
140	FEOVRM140E	125	391,82	577,15
160	FEOVRM160E	150	422,92	722,03
200 (A1)	FEOVRM225E	200	613,76	1021,12
225	FEOVRM225E	200	613,76	1021,12
250	FEOVRM280E	250	1.523,03	-
280	FEOVRM280E	250	1.523,03	-
315	FEOVRM315E	300	1.712,86	-

Válvula de mariposa "WAFER".

Con volante reductor.

Código en FKM termina en "F" en lugar de "E"

(A1) A utilizar con portabridas especial QPV FK/FE no incluido.

Ver portabridas especial QPV FK/FE para válvulas de mariposa en el apartado Accesorios de PVC-U de esta misma tarifa.

Para recambios de las válvulas consultar el último apartado "Recambios" de esta misma tarifa.

**KIT FE/FK**

d	Ref. BICRO	DN	€ BICRO	F € INOX
50	KITFEFK050B	40	64,89	Consultar
63	KITFEFK063B	50	67,91	Consultar
75	KITFEFK075B	65	75,47	Consultar
90	KITFEFK090B	80	85,04	Consultar
110	KITFEFK110B	100	97,80	Consultar
125 (A)	KITFEFK125B	125	212,79	Consultar
140	KITFEFK140B	125	165,10	Consultar
160	KITFEFK160B	150	268,24	Consultar
200 (A)	KITFEFK200B	200	471,24	Consultar
225	KITFEFK225B	200	346,72	Consultar

Kit completo
para válvula de mariposa.
Con tornillos bicromados o inox.

Código en INOX termina en "I"
en lugar de "B"
(A) Con portabridas especial
QPV FK/FE incluido.

**FE/FK**

d	Ref. BICRO	DN	Z	€ BICRO	F € INOX
50	TOR050B	40	4	47,89	70,01
63	TOR063B	50	4	47,89	70,01
75	TOR075B	65	4	47,89	70,01
90	TOR090B	80	8	50,66	157,49
110	TOR110B	100	8	52,49	186,96
125	TOR125B	125	8	84,73	186,96
140	TOR140B	125	8	84,73	186,96
160	TOR160B	150	8	172,24	373,94
200	TOR200B	200	8	172,24	373,94
225	TOR225B	200	8	172,24	373,94

Juego tornillos
para válvula de mariposa.
Bicromados o inox.

Código en INOX termina en "I"
en lugar de "B"
Z= Número de tornillos
Precio juego completo
(tornillos, tuercas y arandelas)

**FKOV/FM**

d	Ref. EPDM	DN	€ EPDM	G € FKM
50	FKOVFM050E	40	178,76	279,31
63	FKOVFM063E	50	189,27	295,77
75	FKOVFM075E	65	210,31	328,59
90	FKOVFM090E	80	228,73	352,26
110	FKOVFM110E	100	247,97	381,18
125 (A1)	FKOVFM140E	125	329,49	510,00
140	FKOVFM140E	125	329,49	510,00
160	FKOVFM160E	150	364,53	551,18
200 (A1)	FKOVFM225E	200	471,44	715,04
225	FKOVFM225E	200	471,44	715,04
250**	FKOVFM280E	250	1.503,03	2.524,86
280**	FKOVFM280E	250	1.503,03	2.524,86
315**	FKOVFM315E	300	1.638,85	2.752,73
355**	FKOVFM355E	350	2.779,93	5.098,18
400**	FKOVFM400E	400	3.164,38	6.513,29

Válvula de mariposa industrial.
A EJE LIBRE.

Para actuar: Cuerpo en PPGR,
eje inoxidable y disco en PVC-U.

Código en FKM termina en "F"
en lugar de "E"
(A1) A utilizar con portabridas especial
QPV FK/FE no incluido.
** ANSI 150 lbs bajo pedido
al mismo precio.

**FKOV/LM**

d	Ref. EPDM	DN	€ EPDM	G € FKM
50	FKOVL050E	40	210,05	310,59
63	FKOVL063E	50	222,39	328,87
75	FKOVL075E	65	247,10	365,41
90	FKOVL090E	80	259,36	382,91
110	FKOVL110E	100	282,16	414,47
125 (A1)	FKOVL140E	125	375,03	554,67
140	FKOVL140E	125	375,03	554,67
160	FKOVL160E	150	404,85	580,09
200 (A1)	FKOVL225E	200	524,02	752,74
225	FKOVL225E	200	524,02	752,74

Válvula de mariposa industrial.
CON MANETA.

Cuerpo en PPGR,
eje inoxidable y disco en PVC-U.

Código en FKM termina en "F"
en lugar de "E"
(A1) A utilizar con portabridas especial
QPV FK/FE no incluido.



FKOV/RM

d	Ref. EPDM	DN	G	
			€ EPDM	€ FKM
75	FKOVRM075E	65	599,38	717,67
90	FKOVRM090E	80	612,50	736,04
110	FKOVRM110E	100	634,41	766,73
125 (A1)	FKOVRM140E	125	727,32	906,93
140	FKOVRM140E	125	727,32	906,93
160	FKOVRM160E	150	757,10	932,37
200 (A1)	FKOVRM225E	200	956,02	1.184,75
225	FKOVRM225E	200	956,02	1.184,75
250**(B)	FKOVRM280E	250	1.753,66	2.766,76
280**	FKOVRM280E	250	1.753,66	2.766,76
315**	FKOVRM315E	300	1.889,51	3.002,51
355**	FKOVRM355E	350	3.426,09	5.744,36
400**	FKOVRM400E	400	3.810,52	7.159,44

Válvula de mariposa industrial.
CON VOLANTE.

Cuerpo en PPGR,
eje inoxidable y disco
en PVC-U.

Código en FKM termina en "F"
en lugar de "E"

(A) A utilizar con portabridas especial
QPV FK/FE no incluido.

(B) A utilizar con tubo D250 SDR26 (PN10)
** ANSI 150 lbs bajo pedido al mismo precio.



FKOV/FM

d	Ref. EPDM	DN	G	
			€ EPDM	€ FKM
75	FKOLVFM075E	65	318,97	437,24
90	FKOLVFM090E	80	370,67	494,24
110	FKOLVFM110E	100	402,21	535,42
125 (A1)	FKOLVFM140E	125	535,42	715,92
140	FKOLVFM140E	125	535,42	715,92
160	FKOLVFM160E	150	587,12	773,78
200 (A1)	FKOLVFM225E	200	701,89	945,47
225	FKOLVFM225E	200	701,89	945,47

Válvula de mariposa industrial.
A EJE LIBRE. LUG ISO-DIN.

Para actuar. Cuerpo en PPGR,
eje inoxidable y disco en PVC-U.

Código en FKM termina en "F"
en lugar de "E"



FKOV/LM

d	Ref. EPDM	DN	G	
			€ EPDM	€ FKM
75	FKOLVLM075E	65	355,74	474,06
90	FKOLVLM090E	80	401,33	524,88
110	FKOLVLM110E	100	436,37	568,71
125 (A1)	FKOLVLM140E	125	580,95	760,58
140	FKOLVLM140E	125	580,95	760,58
160	FKOLVLM160E	150	627,42	802,65
200 (A1)	FKOLVLM225E	200	754,44	983,18
225	FKOLVLM225E	200	754,44	983,18

Válvula de mariposa industrial.
CON MANETA. LUG ISO-DIN.

Cuerpo en PPGR,
eje inoxidable y disco en PVC-U.

Código en FKM termina en "F"
en lugar de "E"

(A1) A utilizar con portabridas
especial QPV FK/FE no incluido.



FKOV/RM

d	Ref. EPDM	DN	G	
			€ EPDM	€ FKM
75	FKOLVRM075E	65	708,05	826,32
90	FKOLVRM090E	80	754,44	877,98
110	FKOLVRM110E	100	788,63	920,95
125 (A1)	FKOLVRM140E	125	933,25	1.112,85
140	FKOLVRM140E	125	933,25	1.112,85
160	FKOLVRM160E	150	979,68	1.154,92
200 (A1)	FKOLVRM225E	200	1.186,46	1.415,19
225	FKOLVRM225E	200	1.186,46	1.415,19

Válvula de mariposa industrial.
CON VOLANTE. LUG ISO-DIN.

Cuerpo en PPGR,
eje inoxidable y disco en PVC-U.

Código en FKM termina en "F"
en lugar de "E"

(A1) A utilizar con portabridas
especial QPV FK/FE no incluido.

**FKOV/FM**

d	Ref. EPDM	DN	G	
			€ EPDM	€ FKM
2½"	FKOALVFM212E	65	373,27	491,57
3"	FKOALVFM300E	80	427,62	551,18
4"	FKOALVFM400E	100	464,42	597,59
5"	FKOALVFM500E	125	617,78	798,29
6"	FKOALVFM600E	150	676,49	863,15
8"	FKOALVFM800E	200	816,66	1.060,26
10"	FKOALVFM810E	250	2.607,80	3.629,65
12"	FKOALVFM812E	300	2.768,97	3.882,87

Válvula de mariposa industrial.
A EJE LIBRE. **LUG** ANSI.

Para actuar. Cuerpo en PPGR,
eje inoxidable y disco en PVC-U.

Código en FKM termina en "F"
en lugar de "E"

**FKOV/LM**

d	Ref. EPDM	DN	G	
			€ EPDM	€ FKM
2½"	FKOALVLM212E	65	410,10	528,39
3"	FKOALVLM300E	80	458,29	581,82
4"	FKOALVLM400E	100	498,61	630,90
5"	FKOALVLM500E	125	663,33	842,99
6"	FKOALVLM600E	150	716,75	892,05
8"	FKOALVLM800E	200	869,21	1.097,94

Válvula de mariposa industrial.
CON MANETA. **LUG** ANSI.

Cuerpo en PPGR,
eje inoxidable y disco en PVC-U.

Código en FKM termina en "F"
en lugar de "E"

**FKOV/RM**

d	Ref. EPDM	DN	G	
			€ EPDM	€ FKM
2½"	FKOALVRM212E	65	762,36	880,65
3"	FKOALVRM300E	80	811,40	934,97
4"	FKOALVRM400E	100	850,83	983,18
5"	FKOALVRM500E	125	1.015,60	1.195,24
6"	FKOALVRM600E	150	1.069,07	1.244,30
8"	FKOALVRM800E	200	1.301,21	1.529,93
10"	FKOALVRM810E	250	2.858,48	3.871,58
12"	FKOALVRM812E	300	3.019,59	4.132,62

Válvula de mariposa industrial.
CON VOLANTE. **LUG** ANSI.

Cuerpo en PPGR,
eje inoxidable y disco en PVC-U.

Código en FKM termina en "F"
en lugar de "E"

Para recambios de las válvulas consultar el último apartado "Recambios" de esta misma tarifa.



DKDV

d	Ref. EPDM	DN	H		
			€ EPDM	€ FKM	€ PTFE
20	DKDV020E	15	58,11	103,08	120,68
25	DKDV025E	20	64,71	108,58	126,10
32	DKDV032E	25	78,99	123,93	142,61
40	DKDV040E	32	93,23	169,97	189,73
50	DKDV050E	40	128,37	203,98	223,74
63	DKDV063E	50	156,79	284,06	280,70
75	DKDV075E	65	188,15	340,85	336,83

Válvula de membrana
DIALOCK®.

M-M encolar.

Código en FKM termina en "F"
en lugar de "E"
Código en PTFE termina en "P"
en lugar de "E"



DKLDV

d	Ref. EPDM	DN	H		
			€ EPDM	€ FKM	€ PTFE
20	DKLDV020E	15	145,79	190,74	208,34
25	DKLDV025E	20	152,39	196,25	213,75
32	DKLDV032E	25	166,65	211,58	230,29
40	DKLDV040E	32	180,89	257,61	277,39
50	DKLDV050E	40	241,07	316,67	326,65
63	DKLDV063E	50	269,50	396,75	381,95
75	DKLDV075E	65	323,40	476,11	458,34

Válvula de membrana
DIALOCK®. CON LIMITADOR
DE CARRERA.

M-M encolar.

Código en FKM termina en "F"
en lugar de "E"
Código en PTFE termina en "P"
en lugar de "E"



VMDV

d	Ref. EPDM	DN	H		
			€ EPDM	€ FKM	€ PTFE
90	VMDV090E	80	449,65	803,84	617,36
110	VMDV110E	100	623,95	1.224,98	831,26

Válvula de membrana.
M-M encolar.

Código en FKM termina en "F"
en lugar de "E"
Código en PTFE termina en "P"
en lugar de "E"



DKUIV

d	Ref. EPDM	DN	H		
			€ EPDM	€ FKM	€ PTFE
20	DKUIV020E	15	70,21	117,32	140,34
25	DKUIV025E	20	76,81	129,43	151,37
32	DKUIV032E	25	95,45	149,21	169,97
40	DKUIV040E	32	114,08	199,56	223,74
50	DKUIV050E	40	155,69	246,77	270,88
63	DKUIV063E	50	191,87	336,63	332,24

Válvula de membrana
DIALOCK®.

Con enlaces H-H para encolar.

Código en FKM termina en "F"
en lugar de "E"
Código en PTFE termina en "P"
en lugar de "E"



DKLUIV

d	Ref. EPDM	DN	H		
			€ EPDM	€ FKM	€ PTFE
20	DKLUIV020E	15	157,87	204,97	228,01
25	DKLUIV025E	20	164,48	217,08	239,04
32	DKLUIV032E	25	183,09	236,88	257,64
40	DKLUIV040E	32	201,74	287,22	311,40
50	DKLUIV050E	40	268,38	359,47	383,58
63	DKLUIV063E	50	304,58	449,34	444,95

Válvula de membrana
DIALOCK®. CON LIMITADOR
DE CARRERA.

Con enlaces H-H para encolar.

Código en FKM termina en "F"
en lugar de "E"
Código en PTFE termina en "P"
en lugar de "E"



DKUFV

Rh	Ref. EPDM	DN	PN	H		
				€ EPDM	€ FKM	€ PTFE
1/2"	DKUFV012E	15	10	76,81	123,93	146,94
3/4"	DKUFV034E	20	10	83,31	137,09	157,94
1"	DKUFV100E	25	10	101,97	154,60	176,54
1 1/4"	DKUFV114E	32	10	134,84	220,40	243,41
1 1/2"	DKUFV120E	40	10	179,88	269,74	294,99
2"	DKUFV200E	50	10	214,90	359,68	354,16

Válvula de membrana
DIALOCK®.

Con enlaces H-H para rosacar.

Código en FKM termina en "F"
en lugar de "E"
Código en PTFE termina en "P"
en lugar de "E"

Para recambios de las válvulas consultar el último apartado "Recambios" de esta misma tarifa.



DKOV

d	Ref. EPDM	DN	PN	€ EPDM	€ FKM	H € PTFE
20	DKOV020E	15	10	96,17	141,13	158,70
25	DKOV025E	20	10	104,64	148,51	166,03
32	DKOV032E	25	10	120,58	165,52	184,17
40	DKOV040E	32	10	148,61	225,35	245,11
50	DKOV050E	40	10	186,45	262,06	281,82
63	DKOV063E	50	10	238,15	365,42	362,07
75	DKOV075E	65	10	309,60	475,05	470,69

Válvula de membrana
DIALOCK®.

Con bridas DIN.

Código en FKM termina en "F"
en lugar de "E"
Código en PTFE termina en "P"
en lugar de "E"

* DIN y ANSI 150 lbs.



DKOAV

d	Ref. EPDM	DN	PN	€ EPDM	€ FKM	H € PTFE
½"	DKOAV012E	15	10	96,17	141,13	158,70
¾"	DKOAV034E	20	10	104,64	148,51	166,03
1"	DKOAV100E	25	10	120,58	165,52	184,17
1¼"	DKOAV114E	32	10	148,61	225,35	245,11
1½"	DKOAV120E	40	10	186,45	262,06	281,82
2"	DKOAV200E	50	10	238,15	365,42	362,07
2½"	DKOAV212E	65	10	309,60	475,05	470,69

Válvula de membrana
DIALOCK®.

Con bridas ANSI 150 lbs.

Código en FKM termina en "F"
en lugar de "E"
Código en PTFE termina en "P"
en lugar de "E"



VMOV

d	Ref. EPDM	DN	€ EPDM	€ FKM	H € PTFE
90	VMOV090E	80	611,15	965,35	778,90
110	VMOV110E	100	812,94	1.413,98	1.020,28

Válvula de membrana.

Con bridas DIN.

Bajo pedido con bridas ANSI 150 lbs.
(con el mismo precio)

Código en FKM termina en "F"
en lugar de "E"
Código en PTFE termina en "P"
en lugar de "E"



CMDV CMIV

M-M encolar. H-H encolar.

CMUIV CMFV

H-H enlaces encolar. H-H roscar.

d-Rh	Ref. EPDM	DN	€ EPDM	€ FKM	H € PTFE
20	CMDV020E	15	57,06	81,12	85,56
16	CMIV016E	12	47,13	65,81	74,56
20	CMIV020E	15	60,30	74,56	80,06
20	CMUIV020E	15	65,80	84,46	87,73
¾"	CMFV038E	12	47,13	65,81	74,56
½"	CMFV012E	15	60,30	74,56	80,06

Válvula de membrana
compacta.

Código en FKM termina en "F"
en lugar de "E"
Código en PTFE termina en "P"
en lugar de "E"



RPDRV

Rm-d	Ref.	DN	U/ 	€ FKM
½"-16	RPDRV012016	15	50	40,25

Grifo de pistón hidroponía.

Membrana en FKM. M espiga - M roscar.



RMRPV

Rm-Pm	Ref.	DN	€ EPDM
½"-20	RMRPV012020E	15	25,09

Grifo de membrana.

Membrana en EPDM. M espiga - M roscar.

Para recambios de las válvulas consultar el último apartado "Recambios" de esta misma tarifa.

VMFV

Rh	Ref.	DN	U/	€ EPDM
¼"	VMFV014E	8	1	35,25

Grifo de membrana.

Membrana en EPDM. H-H roscar.

RMRV

Rm	Ref.	DN	U/	€ EPDM
½"	RMRV012E	15	1	25,09

Grifo de membrana.

Membrana en EPDM. M-M roscar.

VMIV

d	Ref.	DN	U/	€ EPDM
12	VMIV012E	8	1	33,12

Grifo de membrana.

Membrana en EPDM. H-H encolar.

VVUIV

d	Ref.	DN	PN	U/	€ EPDM
16	VVUIV016E	10	16	6	47,13
20	VVUIV020E	15	16	6	48,15
25	VVUIV025E	20	16	6	55,14
32	VVUIV032E	25	16	6	65,64
40	VVUIV040E	32	10	16	86,44
50	VVUIV050E	40	10	16	115,42
63	VVUIV063E	50	10	16	172,84

Válvula asiento inclinado.

Junta EPDM. H-H enlaces para encolar.

VDDV

d	Ref.	DN	PN	U/	€ EPDM
16	VDDV016E	10	16	6	41,18
20	VDDV020E	15	16	6	43,33
25	VDDV025E	20	16	6	47,91
32	VDDV032E	25	16	6	57,06
40	VDDV040E	32	10	16	75,19
50	VDDV050E	40	10	16	100,36
63	VDDV063E	50	10	16	145,85

Válvula asiento inclinado.

Junta EPDM. M-M encolar.

Para recambios de las válvulas consultar el último apartado "Recambios" de esta misma tarifa.



INDUSTRIA

Válvulas manuales de PVC-U presión

Válvulas de retención

**SXEIV**

d	Ref. EPDM	DN	PN	Pack	U/	€ EPDM	€ FKM
16	SXEIV016E	10	16	2	30	21,60	22,85
20	SXEIV020E	15	16	2	30	21,70	22,94
25	SXEIV025E	20	16	2	30	25,07	25,59
32	SXEIV032E	25	16	2	20	26,62	27,80
40	SXEIV040E	32	16	2	14	33,13	37,39
50	SXEIV050E	40	16	2	6	40,77	43,63
63	SXEIV063E	50	16	2	6	59,22	69,55
75	SXEIV075E	65	16	2	2	136,52	146,09
90	SXEIV090E	80	16	2	2	171,26	182,22
110	SXEIV110E	100	16	2	2	224,75	247,92

Válvula de bola anti-retorno.
Juntas en EPDM o FKM. H-H encolar.

Código en FKM termina en "F"
en lugar de "E"

**SXEFV**

Rh	Ref. EPDM	DN	PN	Pack	U/	€ EPDM	€ FKM
3/8"	SXEFV038E	10	16	2	30	23,26	Consultar
1/2"	SXEFV012E	15	16	2	30	23,35	Consultar
3/4"	SXEFV034E	20	16	2	30	27,57	Consultar
1"	SXEFV100E	25	16	2	20	30,57	Consultar
1 1/4"	SXEFV114E	32	16	2	14	36,75	Consultar
1 1/2"	SXEFV112E	40	16	2	6	44,49	Consultar
2"	SXEFV200E	50	16	2	6	70,07	Consultar
2 1/2"	SXEFV212E	65	16	2	2	155,56	165,10
3"	SXEFV300E	80	16	2	2	194,67	205,63
4"	SXEFV400E	100	16	2	2	236,80	259,97

Válvula de bola anti-retorno.
Juntas en EPDM o FKM. H-H roscar.

Código en FKM termina en "F"
en lugar de "E"

**SXEBEV**

d	Ref. EPDM	DN	PN	U/	€ EPDM	€ FKM
75	SXEBEV075E	65	16	1	159,73	166,53
90	SXEBEV090E	80	16	1	200,39	207,73
110	SXEBEV110E	100	16	1	262,96	282,63

Válvula de bola anti-retorno
Junta EPDM o FKM.
Long spigot PE100 SDR11.

Código en FKM termina en "F"
en lugar de "E"

**VZIV**

d-Rh	Ref.	DN	PN	U/	€ EPDM
16-3/8"	VZIV016E	10	16	16	37,90
20-1/2"	VZIV020E	15	16	16	38,85
25-3/4"	VZIV025E	20	16	16	43,88
32-1"	VZIV032E	25	16	6	47,36
40-1 1/4"	VZIV040E	32	16	3	53,40
50-1 1/2"	VZIV050E	40	16	3	74,08
63-2"	VZIV063E	50	16	3	105,60

Válvula de fondo / pie.
Juntas en EPDM.
H-M encolar - H-H roscar.

Se suministra con las piezas necesarias
para convertir la válvula
roscada hembra por ambos extremos.

**SXE SSE**

d	Ref.	DN	€
16-20	HAVXE020	10-15	2,84
25	HAVXE025	20	4,16
32	HAVXE032	25	6,07
40	HAVXE040	32	11,97
50	HAVXE050	40	12,20
63	HAVXE063	50	19,52

Maneta multifunción EASYFIT
Para apretar tuercas de válvulas SXE - SSE.

Para recambios de las válvulas consultar el último apartado "Recambios" de esta misma tarifa.

**SSEIV**

d	Ref. EPDM	DN	PN	Pack	U/	U/	€ EPDM	€ FKM
16	SSEIV016E	10	16	2	30		18,92	20,02
20	SSEIV020E	15	16	2	30		19,00	20,10
25	SSEIV025E	20	16	2	30		21,98	22,44
32	SSEIV032E	25	16	2	20		23,33	24,37
40	SSEIV040E	32	16	2	14		29,04	32,78
50	SSEIV050E	40	16	2	6		35,74	38,25
63	SSEIV063E	50	16	2	6		51,90	60,95
75	SSEIV075E	65	16	-	1		119,65	128,02
90	SSEIV090E	80	16	-	1		150,11	159,69
110	SSEIV110E	100	16	-	1		196,98	217,25

Válvula de retención
con muelle en INOX 316.

Juntas en EPDM o FKM. H-H encolar.

Código en FKM termina en "F"
en lugar de "E"

**SSEFV**

Rh	Ref. EPDM	DN	PN	Pack	U/	U/	€ EPDM	€ FKM
3/8"	SSEFV038E	10	16	2	30		20,38	21,48
1/2"	SSEFV012E	15	16	2	30		20,47	21,57
3/4"	SSEFV034E	20	16	2	30		24,16	24,64
1"	SSEFV100E	25	16	2	20		26,79	27,84
1 1/4"	SSEFV114E	32	16	2	14		32,21	35,94
1 1/2"	SSEFV112E	40	16	2	6		38,98	41,48
2"	SSEFV200E	50	16	2	6		61,41	70,49
2 1/2"	SSEFV212E	65	16	-	1		136,33	144,69
3"	SSEFV300E	80	16	-	1		170,62	180,21
4"	SSEFV400E	100	16	-	1		207,52	227,82

Válvula de retención
con muelle en INOX 316.

Juntas en EPDM o FKM. H-H roscar.

Código en FKM termina en "F"
en lugar de "E"

**SSEIV**

d	Ref. EPDM	DN	PN	Pack	U/	U/	€ EPDM	€ FKM
16	SSEIV016EH	10	16	2	30		56,53	57,64
20	SSEIV020EH	15	16	2	30		56,62	57,70
25	SSEIV025EH	20	16	2	30		61,54	62,01
32	SSEIV032EH	25	16	2	20		60,59	61,63

Válvula de retención
con muelle en HASTELLOY.

Juntas en EPDM o FKM. H-H encolar.

Código en FKM termina en "FH"
en lugar de "EH"

**SSEFV**

Rh	Ref. EPDM	DN	PN	Pack	U/	U/	€ EPDM	€ FKM
3/8"	SSEFV038EH	10	16	2	30		58,17	59,28
1/2"	SSEFV012EH	15	16	2	30		58,30	59,37
3/4"	SSEFV034EH	20	16	2	30		64,05	64,53
1"	SSEFV100EH	25	16	2	20		64,54	65,58

Válvula de retención
con muelle en HASTELLOY.

Juntas en EPDM o FKM. H-H roscar.

Código en FKM termina en "FH"
en lugar de "EH"

**SSEIV**

d	Ref. EPDM	DN	PN	Pack	U/	U/	€ EPDM	€ FKM
40	SSEIV040EOP	32	16	2	14		40,99	44,72
50	SSEIV050EOP	40	16	2	6		48,33	50,83
63	SSEIV063EOP	50	16	2	6		69,04	78,08
75	SSEIV075EOP	65	16	-	1		152,09	152,09
90	SSEIV090EOP	80	16	-	1		184,79	187,28
110	SSEIV110EOP	100	16	-	1		242,14	242,14

Válvula de retención con muelle
en INOX recubierto PTFE.

Juntas en EPDM o FKM. H-H encolar.

Código en FKM termina en "FOP"
en lugar de "EOP"

**SSEFV**

Rh	Ref. EPDM	DN	PN	Pack	U/	U/	€ EPDM	€ FKM
1 1/4"	SSEFV114EOP	32	16	2	14		44,60	48,36
1 1/2"	SSEFV112EOP	40	16	2	6		52,03	54,54
2"	SSEFV200EOP	50	16	2	6		79,89	88,95
2 1/2"	SSEFV212EOP	65	16	1	1		171,14	171,14
3"	SSEFV300EOP	80	16	1	1		210,69	210,69
4"	SSEFV400EOP	100	16	-	1		254,19	254,19

Válvula de retención con muelle
en INOX recubierto PTFE.

Juntas en EPDM o FKM. H-H roscar.

Código en FKM termina en "FOP"
en lugar de "EOP"

Para recambios de las válvulas consultar el último apartado "Recambios" de esta misma tarifa.

**SSEBEV**

d	Ref. EPDM	DN	PN	Pack	U/ 	€ EPDM	€ FKM
75	SSEBEV075E	65	16	-	1	139,98	145,95
90	SSEBEV090E	80	16	-	1	175,62	182,04
110	SSEBEV110E	100	16	-	1	230,43	247,67

Válvula de retención
con muelle en INOX 316.

Juntas en EPDM o FKM.

Long spigot PE100 SDR11.

Código en FKM termina en "F"
en lugar de "E"

**SSEBEV**

d	Ref. EPDM	DN	PN	Pack	U/ 	€ EPDM	€ FKM
75	SSEBEV075E0P	65	16	-	1	173,60	173,40
90	SSEBEV090E0P	80	16	-	1	216,19	213,48
110	SSEBEV110E0P	100	16	-	1	272,70	276,04

Válvula de retención con muelle
en INOX recubierto PTFE.

Juntas en EPDM o FKM.

Long spigot PE100 SDR11.

Código en FKM termina en "F0P"
en lugar de "E0P"

**VRUIV**

d	Ref. EPDM	DN	U/ 	€ EPDM	€ FKM
16	VRUIV016E	10	20	38,08	45,67
20	VRUIV020E	15	20	40,60	48,75
25	VRUIV025E	20	10	47,13	56,53
32	VRUIV032E	25	10	56,33	67,63
40	VRUIV040E	32	6	70,31	84,38
50	VRUIV050E	40	6	99,94	119,92
63	VRUIV063E	50	6	145,50	174,59

Válvula anti-retorno inclinada.

Juntas en EPDM o FKM.

H-H enlaces para encolar.

Código en FKM termina en "F"
en lugar de "E"

**VRUFV**

Rh	Ref.	DN	PN	U/ 	€ EPDM
3/8"	VRUFV038E	10	16	20	54,63
1/2"	VRUFV012E	15	16	20	56,67
3/4"	VRUFV034E	20	16	10	65,64
1"	VRUFV100E	25	16	10	80,86
1 1/4"	VRUFV114E	32	16	6	102,79
1 1/2"	VRUFV112E	40	16	6	135,37
2"	VRUFV200E	50	16	6	179,06

Válvula anti-retorno inclinada.

Juntas en EPDM. H-H enlaces para rosca.

**VRIV**

d	Ref.	DN	PN	U/ 	€ EPDM
75	VRIV075E	65	10	2	217,17
90	VRIV090E	80	6	1	281,85
110	VRIV110E	100	6	1	495,70

Válvula anti-retorno inclinada.

Junta en EPDM. H-H encolar (sin enlaces en los extremos).

**VRFV**

Rh	Ref.	DN	PN	U/ 	€ EPDM
2 1/2"	VRFV212E	65	10	2	302,63
3"	VRFV300E	80	6	1	386,06
4"	VRFV400E	100	6	1	508,89

Válvula anti-retorno inclinada.

Junta en EPDM. H-H rosca (sin enlaces en los extremos).

Para recambios de las válvulas consultar el último apartado "Recambios" de esta misma tarifa.

**VRDV**

d	Ref.	DN	PN	U/ 	€ EPDM
16	VRDV016E	10	16	20	33,12
20	VRDV020E	15	16	20	35,25
25	VRDV025E	20	16	20	40,96
32	VRDV032E	25	16	20	48,98
40	VRDV040E	32	16	12	61,08
50	VRDV050E	40	16	6	86,90
63	VRDV063E	50	16	6	126,10

Válvula anti-retorno inclinada.

Junta en EPDM. M-M encolar .

**SZIV/SZRV***

d macho	Ref. encolar	Ref. roscar	€ encolar	€ roscar
20	SZIV016		13,80	
25-3/4"	SZIV020	SZRV034	14,62	4,58
32-1"	SZIV025	SZRV100	15,42	4,62
40-1 1/4"	SZIV032	SZRV114	16,43	4,83
50-1 1/2"	SZIV040	SZRV112	31,06	6,71
63-2"	SZIV050	SZRV200	31,95	7,43
75	SZIV063		32,96	

Tamiz filtro seguridad.

Para válvulas de fondo/pie. Encolar M / Roscar M.

**FROVE***

d	Ref. EPDM	DN	€ EPDM	€ FKM
40	FROVE040E	32	31,46	41,14
50	FROVE050E	40	33,50	47,90
63	FROVE063E	50	39,69	60,24
75	FROVE075E	65	43,80	69,12
90	FROVE090E	80	51,92	96,73
110	FROVE110E	100	63,72	106,99
125	FROVE125E	110	68,39	109,73
140	FROVE140E	125	73,03	114,51
160	FROVE160E	150	89,62	149,57
200	FROVE200E	175	102,03	187,34
225	FROVE225E	200	106,19	191,63
250	FROVE250E	225	146,68	256,79
280	FROVE280E	250	166,84	300,46
315	FROVE315E	300	250,21	434,13

Válvula anti-retorno de clapeta
sin resorte.

Montaje entre bridas.

Código en FKM termina en "F"
en lugar de "E"**FROVER***

d	Ref. EPDM	DN	€ EPDM	€ FKM
40	FROVER040E	32	106,64	114,90
50	FROVER050E	40	108,71	121,66
63	FROVER063E	50	116,10	134,02
75	FROVER075E	65	120,32	142,91
90	FROVER090E	80	128,68	170,48
110	FROVER110E	100	141,13	179,35
125	FROVER125E	110	150,60	188,39
140	FROVER140E	125	154,54	192,31
160	FROVER160E	150	174,32	230,05
200	FROVER200E	175	193,95	274,57
225	FROVER225E	200	198,28	278,81
250	FROVER250E	225	267,55	365,58
280	FROVER280E	250	259,79	391,66
315	FROVER315E	300	345,93	528,02

Válvula anti-retorno de clapeta
con resorte INOX AISI 302.

Montaje entre bridas.

Código en FKM termina en "F"
en lugar de "E"



INDUSTRIA

Válvulas manuales de PVC-U presión

Conectores

**CVDE**

d	Ref.	Para válvulas	€
20	CVDE11020		4,16
25	CVDE11025		4,26
32	CVDE11032	VKD-VKR-TKD	4,33
40	CVDE11040	VEE-VXE-SXE	6,75
50	CVDE11050	SSE-RV-VV-VR	8,02
63	CVDE11063		11,40
75	CVDE11075	VKD-VEE-VXE-SX/SSE	32,03
90	CVDE11090	VKD	41,63
90	CVDE11090VXE	VEE-VXE-SXE-SSE	41,63
110	CVDE11110	VKD	48,42
110	CVDE11110VXE	VEE-VXE-SXE-SSE	48,42

Conector final en PE100 SDR11

Para soldadura a testa o electrofusión.**Q/BBE-L**

d	Ref.	Para válvulas	€
20	QBBEL11020	DK	5,78
25	QBBEL11025	DK	6,80
32	QBBEL11032	DK	8,64
40	QBBEL11040	DK	11,03
50	QBBEL11050	DK	11,38
63	QBBEL11063	DK	16,59

Conector final en PE100 SDR11

Para soldadura a testa o electrofusión.

Para recambios de las válvulas consultar el último apartado "Recambios" de esta misma tarifa.



RVUIV

d	Ref.	DN	PN	U/	€ EPDM
16	RVUIV016E	10	16	20	31,62
20	RVUIV020E	15	16	20	31,62
25	RVUIV025E	20	16	10	36,59
32	RVUIV032E	25	16	10	49,84
40	RVUIV040E	32	16	6	63,08
50	RVUIV050E	40	16	6	82,59
63	RVUIV063E	50	16	6	107,51

Filtro inclinado PVC-U gris.

Juntas en EPDM. H-H enlaces para encolar.



RVUIT

d	Ref.	DN	PN	U/	€ EPDM
16	RVUIT016E	10	16	20	31,62
20	RVUIT020E	15	16	20	31,62
25	RVUIT025E	20	16	10	36,59
32	RVUIT032E	25	16	10	49,84
40	RVUIT040E	32	10	6	63,08
50	RVUIT050E	40	10	6	82,59
63	RVUIT063E	50	10	6	107,51

Filtro inclinado PVC transparente.

Juntas en EPDM. H-H enlaces para encolar.



RVIV

d	Ref.	DN	PN	U/	€ EPDM
75	RVIV075E	65	10	2	139,81
90	RVIV090E	80	6	1	166,70
110	RVIV110E	100	6	1	392,63

Filtro inclinado PVC-U gris.

H-H encolar (sin enlaces en los extremos).



RVIT

d	Ref.	DN	PN	U/	€ EPDM
75	RVIT075E	65	6	2	148,28
90	RVIT090E	80	4	1	166,70
110	RVIT110E	100	4	1	392,63

Filtro inclinado PVC transparente.

H-H encolar (sin enlaces en los extremos).



RVUFV

Rh	Ref.	DN	PN	U/	€ EPDM
3/8"	RVUFV038E	10	16	20	40,60
1/2"	RVUFV012E	15	16	20	45,11
3/4"	RVUFV034E	20	16	10	53,55
1"	RVUFV100E	25	16	10	70,85
1 1/4"	RVUFV114E	32	16	6	89,89
1 1/2"	RVUFV112E	40	16	6	111,45
2"	RVUFV200E	50	16	6	137,20

Filtro inclinado PVC-U gris.

Juntas en EPDM. H-H enlaces para roscar.



RVFV

Rh	Ref.	DN	PN	U/	€ EPDM
2 1/2"	RVFV212E	65	10	2	223,74
3"	RVFV300E	80	6	1	279,76
4"	RVFV400E	100	6	1	418,90

Filtro inclinado PVC-U gris.

H-H roscar (sin enlaces en los extremos).

Para recambios de las válvulas consultar el último apartado "Recambios" de esta misma tarifa.

**RVUFT**

Rh	Ref.	DN	PN	U/ 	€ EPDM
3/8"	RVUFT038E	10	16	20	40,60
1/2"	RVUFT012E	15	16	20	42,54
3/4"	RVUFT034E	20	16	10	56,25
1"	RVUFT100E	25	16	10	75,02
1 1/4"	RVUFT114E	32	10	6	93,86
1 1/2"	RVUFT112E	40	10	6	114,64
2"	RVUFT200E	50	10	6	147,93

Filtro inclinado **PVC transparente**.

Juntas en EPDM. H-H enlases para roscar.

**RVDT**

d	Ref.	DN	PN	U/ 	€ EPDM
16	RVDT016E	10	10	20	28,52
20	RVDT020E	15	10	20	28,52
25	RVDT025E	20	10	20	33,05
32	RVDT032E	25	10	20	45,06
40	RVDT040E	32	10	12	57,07
50	RVDT050E	40	10	6	74,70
63	RVDT063E	50	10	6	97,24

Filtro inclinado **PVC transparente**.

Junta en EPDM. M-M encolar.

**VAIV**

d-Rh	Ref.	DN	PN	U/ 	€ EPDM
20-1/2"	VAIV020E	15	16	16	38,85
25-3/4"	VAIV025E	20	16	20	43,93
32-1"	VAIV032E	25	16	6	47,60
40-1 1/4"	VAIV040E	32	16	3	51,70
50-1 1/2"	VAIV050E	40	16	3	74,29
63-2"	VAIV063E	50	16	3	108,67

Válvula de purga bola ventosa.

Junta en EPDM.

H-M encolar / H-H roscar.

Se suministra con las piezas necesarias para convertir la válvula roscada hembra por ambos extremos.

Para recambios de las válvulas consultar el último apartado "Recambios" de esta misma tarifa.

**RVDV**

d	Ref.	DN	PN	U/ 	€ EPDM
16	RVDV016E	10	16	20	27,46
20	RVDV020E	15	16	20	27,46
25	RVDV025E	20	16	20	31,76
32	RVDV032E	25	16	20	43,33
40	RVDV040E	32	16	12	68,45
50	RVDV050E	40	16	6	71,84
63	RVDV063E	50	16	6	93,50

Filtro inclinado **PVC-U gris**.

Junta en EPDM. M-M encolar.

**RVFT**

Rh	Ref.	DN	PN	U/ 	€ EPDM
2 1/2"	RVFT212E	65	6	2	230,32
3"	RVFT300E	80	4	1	296,11
4"	RVFT400E	100	4	1	425,47

Filtro inclinado **PVC transparente**.

H-H roscar (sin enlases en los extremos).

**MANGUITO**

d	Ref.	DN	€ PVC-U
16	ENDIV016	10	4,50
20	ENDIV020	15	4,50
25	ENDIV025	20	5,40
32	ENDIV032	25	6,15
40	ENDIV040	32	7,37
50	ENDIV050	40	8,49
63	ENDIV063	50	11,13
75	ENDIV075	65	20,21
90	ENDIV090	80	25,01
90	ENDIV090VXE *	80	25,01
110	ENDIV110	100	42,26
110	ENDIV110VXE *	100	42,26

Manguito **encolar H**.

Para válvulas VKD-VKR-TKD-VXE-VEE-SXE-RV-VR-VV.

* Para válvulas VEE-VXE-SXE-SSE.

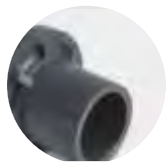
**MANGUITO**

d	Ref.	DN	l € PVC-U
16	ENDDV016	10	4,50
20	ENDDV020	15	4,50
25	ENDDV025	20	5,40
32	ENDDV032	25	6,15
40	ENDDV040	32	7,37
50	ENDDV050	40	8,49
63	ENDDV063	50	11,13
75	ENDDV075	65	19,62
90	ENDDV090	80	24,25
110	ENDDV110	100	42,26

Manguito **encolar M.**

Para válvulas VKD-VKR-TKD-VXE-VEE-SXE-SSE-RV-VR-VV.

**MANGUITO**

Rh	Ref.	DN	l € PVC-U
3/8"	ENDFV038	10	4,50
1/2"	ENDFV012	15	4,50
3/4"	ENDFV034	20	5,40
1"	ENDFV100	25	6,15
1 1/4"	ENDFV114	32	7,37
1 1/2"	ENDFV112	40	8,49
2"	ENDFV200	50	11,13
2 1/2"	ENDFV212	65	19,62
3"	ENDFV300	80	24,25
3"	ENDFV300VXE *	80	24,25
4"	ENDFV400	100	42,26
4"	ENDFV400VXE *	100	42,26

Manguito **roscar H.**

Para válvulas VKD-VKR-TKD-VXE-VEE-SXE-SSE-RV-VR-VV.

* Para válvulas VEE-VXE-SXE-SSE.

**PSKD**

d	Ref.	DN	Ø tubo	l €
16-20	PSKD020	10-15	25	31,38
25	PSKD025	20	25	32,08
32	PSKD032	25	25	32,90
40	PSKD040	32	32	33,27
50	PSKD050	40	32	34,60
63	PSKD063	50	32	38,18

Eje de extensión para encolar a tubo

Tubo no incluido.

Para válvulas de bola VKD-VKR-TKD.

Bajo pedido disponemos también de otras medidas y/o estándares, como encolar BS, ASTM, JIS; y roscar NPT y JIS para todas las válvulas.

Power Quick/CP

H

d	Ref.	DN	ISO	Cuadrado	€
16-20	PQCP020	10-15	F03-04+	11	25,52
25	PQCP025	20	F03-05+	11	27,10
25	PQCP025F04	20	F04	11	27,10
32	PQCP032	25	F03-05+	11	27,10
32	PQCP032F04	25	F04	11	27,10
40	PQCP040	32	F05-07+	14	30,97
50	PQCP050	40	F05-07+	14	30,97
63	PQCP063	50	F05-07+	14	32,91

 Kit de actuación **neumático**.

+ Para final de carrera tipo MSKD.

Para válvulas VKD-VKR-TKD.

Power Quick/CE

H

d	Ref.	DN	ISO	Cuadrado	€
16-20	PQCE020	10-15	F03-04	14	25,52
25	PQCE025	20	F03-05	14	27,10
25	PQCE025F04	20	F04	14	27,10
32	PQCE032	25	F03-05	14	27,10
32	PQCE032F04	25	F04	14	27,10
40	PQCE040	32	F05-07	14	30,97
50	PQCE050	40	F05-07	14	30,97
63	PQCE063	50	F05-07	14	32,91

 Kit de actuación **eléctrico**.

Para válvulas VKD-VKR-TKD.

Power Quick

I

d	Ref.	DN	€
75	PQE090	65	91,09
90	PQE090	80	91,09
110	PQE110	100	100,19

 Adaptador para actuador **eléctrico y neumático**.

Para válvulas de bola VXE.

SOPORTE*

D

d	Ref.	DN	€
16-20	PQCECP020D	10-15	66,33
25	PQCECP025D	20	66,33
32	PQCECP032D	25	66,33
40	PQCECP040D	32	68,83
50	PQCECP050D	40	68,83
63	PQCECP063D	50	68,83

 Kit de actuación **eléctrico y neumático**.

Para válvulas VKD-VKR-TKD.

VKD

I

d	Ref.	DN	€
75-110	AKVKD075110	65-100	49,06

Kit de actuación.

Adaptador para actuador compuesto por plato, reductor y tornillos.

Para válvulas VKD.

FK

I

d	Ref.	DN	€
50-160	FKADA160	40-150	17,56
225	FKADA225	200	21,37

Kit de actuación.

Adaptador para actuador.

Para válvulas de mariposa FK.

**LS QUICK KIT**

H

d	Ref.	DN	€
16-20	LSQKIT20	10-15	48,76
25	LSQKIT25	20	51,61
32	LSQKIT32	25	51,61
40	LSQKIT40	32	59,00
50	LSQKIT50	40	59,00
63	LSQKIT63	50	62,68

Accesorios de conexión para final de carrera LSQT.

Para válvulas VKD-TKD.

LS QUICK KIT

H

d	Ref.	DN	€
50	LSQKITFK5063	40	86,43
63	LSQKITFK5063	50	86,43
75	LSQKITFK75160	65	116,39
90	LSQKITFK75160	80	116,39
110	LSQKITFK75160	100	116,39
140	LSQKITFK75160	125	116,39
160	LSQKITFK75160	150	116,39
225	LSQKIT225	200	124,24

Accesorios de conexión para final de carrera LSQT.

Para válvulas FK.

**LS QUICK KIT**

H

d	Ref.	DN	€
75	LSQKIT75160	65	116,39
90	LSQKIT75160	80	116,39
110	LSQKIT75160	100	116,39

Accesorios de conexión para final de carrera LSQT.

Para válvulas VKD.

FINALES DE CARRERA

H

d	Ref.	DN	€
Todos	LSQTMEC	Todos	150,15

Finales de carrera ELECTROMECAÑICOS IP67.

Para válvulas VKD-TKD-FK

d	Ref.	DN	€
Todos	LSQTPNP	Todos	258,45

Finales de carrera Inductivos PNP (3 hilos).

Para válvulas VKD-TKD-FK

**PMKD**

H

d	Ref.	DN	€
16-32	PMKD1	10-25	7,65
40-63	PMKD2	32-50	8,33

Pletinas de sujeción.

Para válvulas de bola VKD-VKR.

**PMKD KIT**

H

d	Ref.	DN	€
16-32	KITPMKD1	10-25	9,50
40-63	KITPMKD2	32-50	10,01

Pletinas de sujeción con tornillos e insertos.

Para válvulas de bola VKD-VKR.

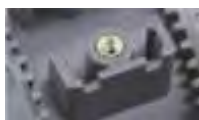

INSERTOS

H

d	Ref.	DN	€
16-32	SINSM04X	10-25	73,83
40-63	SINSM06X	32-50	81,63

Insertos roscados en **acero inoxidable**.
 20 piezas. Para válvulas de bola VKD-VKR.



SHKD

H

d	Ref.	DN	€
16-20	SHKD020	10-15	14,43
25-32	SHKD032	20-25	16,11
40-50	SHKD050	32-40	18,68
63	SHKD063	50	20,00

Kit de seguridad.

Para válvula VKD (maneta no incluida).



LCE

C

d	Ref.	DN	€
16-20	LCE020	10-15	35,37
25	LCE025	20	35,53
32	LCE032	25	37,81
40	LCE040	32-65-80-110(VEE)	39,01
50-72-110	LCE050	40	40,38
63-75-110	LCE063	50-65-80-110(VXE y SSE)	52,08

Tapón + Disco para VEE, VXE, SXE y SSE. Set con 20 piezas de cada
 Tapón transparente y disco en PVC blanco.



PSE

H

d	Ref.	DN	Ø tubo	€
75	PSE090	65	63	51,27
90	PSE090	80	63	51,27
110	PSE110	100	63	51,27

Para válvula de bola VEE-VXE.



PMDK

H

d	Ref.	DN	€
20-32	PMDK1	15-25	13,29
40-75	PMDK2	32-65	15,43

Para válvula de membrana DK.
 Paletinas de sujeción.



PMDK KIT

H

d	Ref.	DN	€
20-32	KITPMDK1	15-25	17,18
40-75	KITPMDK2	32-65	19,31

Para válvula de membrana DK.
 Paletinas de sujeción con tornillos e insertos.



ZPL

H

d	Ref.	DN	€
16-20	ZPL2415002	12-15	11,76

Plato separador para válvulas de membrana CM.

Para recambios de las válvulas consultar el último apartado "Recambios" de esta misma tarifa.

Válvulas de solenoide

Válvulas de bola 2 y 3 vías

Válvulas de mariposa

Actuadores y accesorios

Válvulas de membrana

Accesorios válvulas de membrana

Válvulas de control de presión

Válvulas motorizadas PVC-U presión

INDUSTRIA





Válvulas motorizadas

Motorizando nuestra válvula industrial conseguimos que nuestras válvulas (con el par más bajo del mercado siendo estanca) puedan trabajar con un número de aperturas y cierres muy por encima de la media.

NO TODAS LAS VÁLVULAS MOTORIZADAS DEL MERCADO SON IGUALES O SEMEJANTES.

En estos artículos, donde el precio del actuador es más elevado que el de la válvula, es donde más énfasis hay que tener en colocar la mejor válvula del mercado. El precio de la válvula no se apreciará porque quedará absorbido por el precio del actuador. Una buena válvula hará que alargue su uso, su mantenimiento, su seguridad y su durabilidad.





INDUSTRIA

Válvulas motorizadas de PVC-U presión

Válvulas de solenoide



Serie:	Modelo pequeño	S1	1	2	3	4	5	6	7
	Modelo grande	S2							
Vías:	Dos vías		2						
Conexión:	Encolar		I						
	Roscar		F						
DN:	Modelo pequeño	4-6-8							
	Modelo grande	8-10-15							
Diámetro:	Modelo pequeño	10-12-16-1/4"-3/8"							
	Modelo grande	16-20-3/8"-1/2"							
Juntas:	EPDM-FKM								
Voltaje:	12V-24V-48V-110V-230V								
Corriente:	AC-DC								

Parámetros necesarios para pedir una válvula de solenoide.

S12-S22

d	Modelo encolar	Rh	Modelo roscar	DN	€ EPDM	€ FKM
10	S12IV	1/4"	S12FV	4-6-8-10	213,63	225,64
12	S12IV	3/8"	S12FV	4-6-8-10	213,63	225,64
16	S12IV			4-6-8-10	213,63	225,64
16	S22IV	3/8"	S22FV	8-10-15	271,98	293,32
20	S22IV	1/2"	S22FV	8-10-15	271,98	293,32

Resúmen
válvulas de solenoide 2 vías.

Bajo pedido:
48, 110 V AC 50/60 Hz y 12, 48 V DC
Precio extra
voltaje no estándar: 19,58 €/Un.

Voltaje estándar
24 ó 230 V AC 50/60 Hz, 24 V DC

S12IV



d	Ref.	DN	Voltaje	Corriente	J € EPDM
16	S12I0416E2A	04	24 V*	Alternativa	213,63
16	S12I0616E2A	06	24 V*	Alternativa	213,63
16	S12I0816E2A	08	24 V*	Alternativa	213,63
16	S12I0416E2C	04	24 V*	Continua	213,63
16	S12I0616E2C	06	24 V*	Continua	213,63
16	S12I0816E2C	08	24 V*	Continua	213,63
16	S12I0416E3A	04	48 V	Alternativa	234,98
16	S12I0616E3A	06	48 V	Alternativa	234,98
16	S12I0816E3A	08	48 V	Alternativa	234,98
16	S12I0416E3C	04	48 V	Continua	234,98
16	S12I0616E3C	06	48 V	Continua	234,98
16	S12I0816E3C	08	48 V	Continua	234,98
16	S12I0416E4A	04	110 V	Alternativa	234,98
16	S12I0616E4A	06	110 V	Alternativa	234,98
16	S12I0816E4A	08	110 V	Alternativa	234,98
16	S12I0416E5A	04	230 V*	Alternativa	213,63
16	S12I0616E5A	06	230 V*	Alternativa	213,63
16	S12I0816E5A	08	230 V*	Alternativa	213,63

Válvula de solenoide 2 vías **ENCOLAR**. Modelo pequeño.
Juntas EPDM. H-H encolar.

* Voltaje estándar. Disponibles otras conexiones para encolar: BS y ASTM
Disponibles también en diámetro exterior Ø 10 y 12 mm. al mismo precio que las de Ø 16 mm.

S12IV



d	Ref.	DN	Voltaje	Corriente	J € FKM
16	S12I0416F2A	04	24 V*	Alternativa	225,64
16	S12I0616F2A	06	24 V*	Alternativa	225,64
16	S12I0816F2A	08	24 V*	Alternativa	225,64
16	S12I1016F2A	10	24 V*	Alternativa	225,64
16	S12I0416F2C	04	24 V*	Continua	225,64
16	S12I0616F2C	06	24 V*	Continua	225,64
16	S12I0816F2C	08	24 V*	Continua	225,64
16	S12I0416F3A	04	48 V	Alternativa	247,00
16	S12I0616F3A	06	48 V	Alternativa	247,00
16	S12I0816F3A	08	48 V	Alternativa	247,00
16	S12I0416F3C	04	48 V	Continua	247,00
16	S12I0616F3C	06	48 V	Continua	247,00
16	S12I0816F3C	08	48 V	Continua	247,00
16	S12I0416F4A	04	110 V	Alternativa	247,00
16	S12I0616F4A	06	110 V	Alternativa	247,00
16	S12I0816F4A	08	110 V	Alternativa	247,00
16	S12I0416F5A	04	230 V*	Alternativa	225,64
16	S12I0616F5A	06	230 V*	Alternativa	225,64
16	S12I0816F5A	08	230 V*	Alternativa	225,64
16	S12I1016F5A	10	230 V*	Alternativa	225,64

Válvula de solenoide 2 vías **ENCOLAR**. Modelo pequeño.
Juntas FKM. H-H encolar.

* Voltaje estándar. Disponibles otras conexiones para encolar: BS y ASTM
Disponibles también en diámetro exterior Ø 10 y 12 mm. al mismo precio que las de Ø 16 mm.

Marcadas en amarillo los modelos estándar

**S12FV**

Rh	Ref.	DN	Voltaje	Corriente	J € EPDM
3/8"	S12F0438E2A	04	24 V*	Alternativa	213,63
3/8"	S12F0638E2A	06	24 V*	Alternativa	213,63
3/8"	S12F0838E2A	08	24 V*	Alternativa	213,63
3/8"	S12F0438E2C	04	24 V*	Continua	213,63
3/8"	S12F0638E2C	06	24 V*	Continua	213,63
3/8"	S12F0838E2C	08	24 V*	Continua	213,63
3/8"	S12F0438E3A	04	48 V	Alternativa	234,98
3/8"	S12F0638E3A	06	48 V	Alternativa	234,98
3/8"	S12F0838E3A	08	48 V	Alternativa	234,98
3/8"	S12F0438E3C	04	48 V	Continua	234,98
3/8"	S12F0638E3C	06	48 V	Continua	234,98
3/8"	S12F0838E3C	08	48 V	Continua	234,98
3/8"	S12F0438E4A	04	110 V	Alternativa	234,98
3/8"	S12F0638E4A	06	110 V	Alternativa	234,98
3/8"	S12F0838E4A	08	110 V	Alternativa	234,98
3/8"	S12F0438E5A	04	230 V*	Alternativa	213,63
3/8"	S12F0638E5A	06	230 V*	Alternativa	213,63
3/8"	S12F0838E5A	08	230 V*	Alternativa	213,63

Válvula de solenoide 2 vías **ROSCAR**. Modelo pequeño.

Juntas EPDM. H-H rosca.

* Voltaje estándar. Disponibles otras conexiones para encolar: NPT
Disponibles también en diámetro exterior Ø 1/4" al mismo precio que las de diámetro exterior Ø 3/8"

S12FV

Rh	Ref.	DN	Voltaje	Corriente	J € FKM
3/8"	S12F0438F2A	04	24 V*	Alternativa	225,64
3/8"	S12F0638F2A	06	24 V*	Alternativa	225,64
3/8"	S12F0838F2A	08	24 V*	Alternativa	225,64
3/8"	S12F1038F2A	10	24 V*	Alternativa	225,64
3/8"	S12F0438F2C	04	24 V*	Continua	225,64
3/8"	S12F0638F2C	06	24 V*	Continua	225,64
3/8"	S12F0838F2C	08	24 V*	Continua	225,64
3/8"	S12F0438F3A	04	48 V	Alternativa	247,00
3/8"	S12F0638F3A	06	48 V	Alternativa	247,00
3/8"	S12F0838F3A	08	48 V	Alternativa	247,00
3/8"	S12F0438F3C	04	48 V	Continua	247,00
3/8"	S12F0638F3C	06	48 V	Continua	247,00
3/8"	S12F0838F3C	08	48 V	Continua	247,00
3/8"	S12F0438F4A	04	110 V	Alternativa	247,00
3/8"	S12F0638F4A	06	110 V	Alternativa	247,00
3/8"	S12F0838F4A	08	110 V	Alternativa	247,00
3/8"	S12F0438F5A	04	230 V*	Alternativa	225,64
3/8"	S12F0638F5A	06	230 V*	Alternativa	225,64
3/8"	S12F0838F5A	08	230 V*	Alternativa	225,64
3/8"	S12F1038F5A	10	230 V*	Alternativa	225,64

Válvula de solenoide 2 vías **ROSCAR**. Modelo pequeño.

Juntas FKM. H-H rosca.

* Voltaje estándar. Disponibles otras conexiones para encolar: NPT
Disponibles también en diámetro exterior Ø 1/4" al mismo precio que las de diámetro exterior Ø 3/8"

Markadas en amarillo los modelos estándar

**S22IV**

d	Ref.	DN	Voltaje	Corriente	J € EPDM
20	S22I0820E2A	08	24 V*	Alternativa	271,98
20	S22I1020E2A	10	24 V*	Alternativa	271,98
20	S22I1520E2A	15	24 V*	Alternativa	271,98
20	S22I0820E2C	08	24 V*	Continua	271,98
20	S22I1020E2C	10	24 V*	Continua	271,98
20	S22I1520E2C	15	24 V*	Continua	271,98
20	S22I0820E3A	08	48 V	Alternativa	293,32
20	S22I1020E3A	10	48 V	Alternativa	293,32
20	S22I1520E3A	15	48 V	Alternativa	293,32

Válvula de solenoide 2 vías **ENCOLAR**. Modelo grande.

Juntas EPDM.

H-H encolar.

d	Ref.	DN	Voltaje	Corriente	J € EPDM
20	S22I0820E3C	08	48 V	Continua	293,32
20	S22I1020E3C	10	48 V	Continua	293,32
20	S22I1520E3C	15	48 V	Continua	293,32
20	S22I0820E4A	08	110 V	Alternativa	293,32
20	S22I0820E4A	10	110 V	Alternativa	293,32
20	S22I1520E4A	15	110 V	Alternativa	293,32
20	S22I0820E5A	08	230 V*	Alternativa	271,98
20	S22I1020E5A	10	230 V*	Alternativa	271,98
20	S22I1520E5A	15	230 V*	Alternativa	271,98

* Voltaje estándar. Disponibles otras conexiones para encolar: BS y ASTM
Disponibles también en diámetro exterior Ø 16 mm. al mismo precio que las de Ø 20 mm.



S22IV

d	Ref.	DN	Voltaje	Corriente	€ FKM
20	S22I0820F2A	08	24 V*	Alterna	286,74
20	S22I1020F2A	10	24 V*	Alterna	286,74
20	S22I1520F2A	15	24 V*	Alterna	286,74
20	S22I0820F2C	08	24 V*	Continua	286,74
20	S22I1020F2C	10	24 V*	Continua	286,74
20	S22I1520F2C	15	24 V*	Continua	286,74
20	S22I0820F3A	08	48 V	Alterna	308,07
20	S22I1020F3A	10	48 V	Alterna	308,07
20	S22I1520F3A	15	48 V	Alterna	308,07

Válvula de solenoide 2 vías **ENCOLAR**. Modelo grande.

Juntas FKM.

H-H encolar.

Marcadas en amarillo los modelos estándar

d	Ref.	DN	Voltaje	Corriente	€ FKM
20	S22I0820F3C	08	48 V	Continua	308,07
20	S22I1020F3C	10	48 V	Continua	308,07
20	S22I1520F3C	15	48 V	Continua	308,07
20	S22I0820F4A	08	110 V	Alterna	308,07
20	S22I0820F4A	10	110 V	Alterna	308,07
20	S22I1520F4A	15	110 V	Alterna	308,07
20	S22I0820F5A	08	230 V*	Alterna	286,74
20	S22I1020F5A	10	230 V*	Alterna	286,74
20	S22I1520F5A	15	230 V*	Alterna	286,74

* Voltaje estándar. Disponibles otras conexiones para encolar: BS y ASTM
Disponibles también en diámetro exterior Ø 16 mm. al mismo precio que las de Ø 20 mm.



S22FV

Rh	Ref.	DN	Voltaje	Corriente	€ EPDM
½"	S22F0812E2A	08	24 V*	Alterna	271,98
½"	S22F1012E2A	10	24 V*	Alterna	271,98
½"	S22F1512E2A	15	24 V*	Alterna	271,98
½"	S22F0812E2C	08	24 V*	Continua	271,98
½"	S22F1012E2C	10	24 V*	Continua	271,98
½"	S22F1512E2C	15	24 V*	Continua	271,98
½"	S22F0812E3A	08	48 V	Alterna	293,32
½"	S22F1012E3A	10	48 V	Alterna	293,32
½"	S22F1512E3A	15	48 V	Alterna	293,32
½"	S22F0812E3C	08	48 V	Continua	293,32
½"	S22F1012E3C	10	48 V	Continua	293,32
½"	S22F1512E3C	15	48 V	Continua	293,32
½"	S22F0812E4A	08	110 V	Alterna	293,32
½"	S22F0812E4A	10	110 V	Alterna	293,32
½"	S22F1512E4A	15	110 V	Alterna	293,32
½"	S22F0812E5A	08	230 V*	Alterna	271,98
½"	S22F1012E5A	10	230 V*	Alterna	271,98
½"	S22F1512E5A	15	230 V*	Alterna	271,98

Válvula de solenoide 2 vías **ROSCAR**. Modelo grande.

Juntas EPDM. H-H roscar. Disponibles otras conexiones para encolar: NPT.

* Voltaje estándar. Disponibles también en diámetro exterior Ø 3/8" al mismo precio que las de diámetro exterior Ø 1/2"



S22FV

Rh	Ref.	DN	Voltaje	Corriente	€ FKM
½"	S22F0812F2A	08	24 V*	Alterna	286,74
½"	S22F1012F2A	10	24 V*	Alterna	286,74
½"	S22F1512F2A	15	24 V*	Alterna	286,74
½"	S22F0812F2C	08	24 V*	Continua	286,74
½"	S22F1012F2C	10	24 V*	Continua	286,74
½"	S22F1512F2C	15	24 V*	Continua	286,74
½"	S22F0812F3A	08	48 V	Alterna	308,07
½"	S22F1012F3A	10	48 V	Alterna	308,07
½"	S22F1512F3A	15	48 V	Alterna	308,07
½"	S22F0812F3C	08	48 V	Continua	308,07
½"	S22F1012F3C	10	48 V	Continua	308,07
½"	S22F1512F3C	15	48 V	Continua	308,07
½"	S22F0812F4A	08	110 V	Alterna	308,07
½"	S22F0812F4A	10	110 V	Alterna	308,07
½"	S22F1512F4A	15	110 V	Alterna	308,07
½"	S22F0812F5A	08	230 V*	Alterna	286,74
½"	S22F1012F5A	10	230 V*	Alterna	286,74
½"	S22F1512F5A	15	230 V*	Alterna	286,74

Válvula de solenoide 2 vías **ROSCAR**. Modelo grande.

Juntas FKM. H-H roscar.

Marcadas en amarillo los modelos estándar

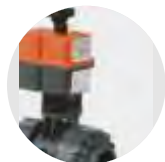

VKDIV/CE

encolar.

VKDFV/CE

roscar.

K

ACTUACIÓN ELÉCTRICA

ACTUACIÓN ELÉCTRICA CON BLOQUE DE SEGURIDAD

d-Rh	24-240 V AC/DC		24-240 V AC/DC		24-240 V AC/DC		24-240 V AC/DC	
	Ref.	€ EPDM	Ref.	€ FKM	Ref.	€ EPDM	Ref.	€ FKM
16	VKVE016E2D	558,26	VKVE016F2D	566,13	VKVE016E2BD	1.053,13	VKVE016F2BD	1.061,01
20	VKVE020E2D	559,73	VKVE020F2D	567,30	VKVE020E2BD	1.054,60	VKVE020F2BD	1.062,18
25	VKVE025E2D	569,33	VKVE025F2D	579,06	VKVE025E2BD	1.064,23	VKVE025F2BD	1.073,92
32	VKVE032E2D	580,60	VKVE032F2D	592,44	VKVE032E2BD	1.075,45	VKVE032F2BD	1.087,33
40	VKVE040E2D	600,93	VKVE040F2D	613,86	VKVE040E2BD	1.095,81	VKVE040F2BD	1.108,73
50	VKVE050E2D	621,38	VKVE050F2D	637,51	VKVE050E2BD	1.116,24	VKVE050F2BD	1.132,40
63	VKVE063E2D	646,88	VKVE063F2D	678,77	VKVE063E2BD	1.141,75	VKVE063F2BD	1.173,65
75	VKVE075E2D	1.035,69	VKVE075F2D	1.099,74	VKVE075E2BD	1.530,57	VKVE075F2BD	1.594,61
90	VKVE090E2D	1.124,72	VKVE090F2D	1.202,84	VKVE090E2BD	1.619,60	VKVE090F2BD	1.697,70
110	VKVE110E2D	1.513,23	VKVE110F2D	1.621,04	VKVE110E2BD	2.008,12	VKVE110F2BD	2.115,90

ENCOLAR

ENCOLAR

3/8"	VKVE038E2D	561,11	VKVE038F2D	569,49	VKVE038E2BD	1.055,99	VKVE038F2BD	1.064,36
1/2"	VKVE012E2D	563,05	VKVE012F2D	571,30	VKVE012E2BD	1.057,92	VKVE012F2BD	1.066,17
3/4"	VKVE034E2D	573,84	VKVE034F2D	581,82	VKVE034E2BD	1.068,71	VKVE034F2BD	1.076,68
1"	VKVE100E2D	585,24	VKVE100F2D	601,18	VKVE100E2BD	1.080,12	VKVE100F2BD	1.096,07
1 1/4"	VKVE114E2D	608,29	VKVE114F2D	621,50	VKVE114E2BD	1.103,17	VKVE114F2BD	1.116,34
1 1/2"	VKVE112E2D	632,57	VKVE112F2D	649,23	VKVE112E2BD	1.127,44	VKVE112F2BD	1.144,11
2"	VKVE200E2D	662,32	VKVE200F2D	695,39	VKVE200E2BD	1.157,18	VKVE200F2BD	1.190,26
2 1/2"	VKVE212E2D	1.061,72	VKVE212F2D	1.125,76	VKVE212E2BD	1.556,58	VKVE212F2BD	1.620,62
3"	VKVE300E2D	1.157,85	VKVE300F2D	1.236,01	VKVE300E2BD	1.652,73	VKVE300F2BD	1.730,87
4"	VKVE400E2D	1.550,49	VKVE400F2D	1.658,30	VKVE400E2BD	2.045,37	VKVE400F2BD	2.153,16

ROSCAR

ROSCAR

Válvula de bola motorizada en PVC-U 2 vías DUAL BLOCK®. Actuación eléctrica.

Disponemos de otras conexiones bajo pedido: bridas, encolar (BS, ASTM, JIS) y roscar (NPT, JIS)

Bajo pedido podemos suministrar otros actuadores: VALPES, BELIMO...

Bajo pedido también disponibles en 12V AC/DC



K

VKRIV/CE

encolar.

VKRIV/CE

roscar.

ACTUACIÓN ELÉCTRICA 24-240 V AC/DC CON POSICIONADOR 4-20 mA

d	Ref.	€ EPDM	Ref.	€ FKM	Ref.	€ EPDM	Ref.	€ FKM	Rh
16	VRVE016E2PD	1.086,25	VRVE016F2PD	1.094,12	VRVE038E2PD	1.089,17	VRVE038F2PD	1.089,17	3/8"
20	VRVE020E2PD	1.087,78	VRVE020F2PD	1.095,29	VRVE012E2PD	1.091,05	VRVE012F2PD	1.091,05	1/2"
25	VRVE025E2PD	1.109,15	VRVE025F2PD	1.118,82	VRVE034E2PD	1.113,60	VRVE034F2PD	1.113,60	3/4"
32	VRVE032E2PD	1.143,47	VRVE032F2PD	1.155,34	VRVE100E2PD	1.148,16	VRVE100F2PD	1.148,16	1"
40	VRVE040E2PD	1.161,54	VRVE040F2PD	1.174,48	VRVE114E2PD	1.168,89	VRVE114F2PD	1.168,89	1 1/4"
50	VRVE050E2PD	1.228,59	VRVE050F2PD	1.244,75	VRVE112E2PD	1.239,84	VRVE112F2PD	1.239,84	1 1/2"
63	VRVE063E2PD	1.243,57	VRVE063F2PD	1.275,51	VRVE200E2PD	1.259,05	VRVE200F2PD	1.259,05	2"

ENCOLAR

ROSCAR

Válvula de bola REGULACIÓN motorizada en PVC-U 2 vías DUAL BLOCK®. Actuación eléctrica con posicionador 4-20 mA

Disponemos de otras conexiones bajo pedido:

bridas, encolar (BS, ASTM, JIS) y roscar (NPT, JIS)

Bajo pedido también disponibles en 12V AC/DC



K

VKDIV/CP

encolar.

VKDFV/CP

roscar.

ACTUACIÓN NEUMÁTICA ALUMINIO

ACTUACIÓN NEUMÁTICA ALUMINIO CON ELECTROVÁLVULA, FINALES DE CARRERA (ELECTROMECÁNICOS) Y REGULADORES DE ESCAPE

d-Rh	DOBLE EFECTO		SIMPLE EFECTO		DOBLE EFECTO		SIMPLE EFECTO	
	Ref.	€	Ref.	€	Ref.	€	Ref.	€
16	VKVP016EDED	257,25	VKVP016ESED	284,64	VKVP016EDEFD	436,24	VKVP016ESEFD	473,08
20	VKVP020EDED	258,72	VKVP020ESED	286,11	VKVP020EDEFD	437,73	VKVP020ESEFD	474,57
25	VKVP025EDED	268,34	VKVP025ESED	295,74	VKVP025EDEFD	447,34	VKVP025ESEFD	484,20
32	VKVP032EDED	279,60	VKVP032ESED	306,97	VKVP032EDEFD	458,59	VKVP032ESEFD	495,44
40	VKVP040EDED	299,93	VKVP040ESED	327,33	VKVP040EDEFD	478,93	VKVP040ESEFD	515,79
50	VKVP050EDED	320,39	VKVP050ESED	400,98	VKVP050EDEFD	499,37	VKVP050ESEFD	589,42
63	VKVP063EDED	345,87	VKVP063ESED	496,88	VKVP063EDEFD	524,86	VKVP063ESEFD	685,32
75	VKVP075EDED	590,77	VKVP075ESED	697,58	VKVP075EDEFD	769,75	VKVP075ESEFD	886,03
90	VKVP090EDED	679,81	VKVP090ESED	786,61	VKVP090EDEFD	858,79	VKVP090ESEFD	975,08
110	VKVP110EDED	755,46	VKVP110ESED	1.133,52	VKVP110EDEFD	934,45	VKVP110ESEFD	1.321,97
3/8"	VKVP038EDED	260,11	VKVP038ESED	287,52	VKVP038EDEFD	439,12	VKVP038ESEFD	475,96
1/2"	VKVP012EDED	262,06	VKVP012ESED	289,44	VKVP012EDEFD	441,05	VKVP012ESEFD	477,90
3/4"	VKVP034EDED	272,83	VKVP034ESED	300,24	VKVP034EDEFD	451,83	VKVP034ESEFD	488,68
1"	VKVP100EDED	284,23	VKVP100ESED	311,64	VKVP100EDEFD	463,24	VKVP100ESEFD	500,08
1 1/4"	VKVP114EDED	307,28	VKVP114ESED	334,70	VKVP114EDEFD	486,29	VKVP114ESEFD	523,15
1 1/2"	VKVP112EDED	331,57	VKVP112ESED	412,17	VKVP112EDEFD	510,57	VKVP112ESEFD	600,63
2"	VKVP200EDED	361,32	VKVP200ESED	512,30	VKVP200EDEFD	540,29	VKVP200ESEFD	700,75
2 1/2"	VKVP212EDED	616,79	VKVP212ESED	723,61	VKVP212EDEFD	795,78	VKVP212ESEFD	912,07
3"	VKVP300EDED	712,93	VKVP300ESED	819,75	VKVP300EDEFD	891,92	VKVP300ESEFD	1.008,18
4"	VKVP400EDED	792,71	VKVP400ESED	1.170,80	VKVP400EDEFD	971,72	VKVP400ESEFD	1.359,23
16	VKVP016FDED	265,12	VKVP016FSED	292,52	VKVP016FDEFD	444,12	VKVP016FSEFD	480,97
20	VKVP020FDED	266,30	VKVP020FSED	293,70	VKVP020FDEFD	445,29	VKVP020FSEFD	482,14
25	VKVP025FDED	278,06	VKVP025FSED	305,46	VKVP025FDEFD	457,06	VKVP025FSEFD	493,91
32	VKVP032FDED	291,44	VKVP032FSED	318,84	VKVP032FDEFD	470,45	VKVP032FSEFD	507,29
40	VKVP040FDED	312,87	VKVP040FSED	340,26	VKVP040FDEFD	491,86	VKVP040FSEFD	528,71
50	VKVP050FDED	336,52	VKVP050FSED	417,12	VKVP050FDEFD	515,53	VKVP050FSEFD	605,58
63	VKVP063FDED	377,76	VKVP063FSED	528,76	VKVP063FDEFD	556,77	VKVP063FSEFD	717,22
75	VKVP075FDED	654,80	VKVP075FSED	761,63	VKVP075FDEFD	833,80	VKVP075FSEFD	950,08
90	VKVP090FDED	757,89	VKVP090FSED	864,73	VKVP090FDEFD	936,89	VKVP090FSEFD	1.053,18
110	VKVP110FDED	863,24	VKVP110FSED	1.241,33	VKVP110FDEFD	1.042,24	VKVP110FSEFD	1.429,78
3/8"	VKVP038FDED	268,50	VKVP038FSED	295,90	VKVP038FDEFD	447,48	VKVP038FSEFD	484,35
1/2"	VKVP012FDED	270,30	VKVP012FSED	297,68	VKVP012FDEFD	449,29	VKVP012FSEFD	486,15
3/4"	VKVP034FDED	280,81	VKVP034FSED	308,21	VKVP034FDEFD	459,83	VKVP034FSEFD	496,66
1"	VKVP100FDED	300,19	VKVP100FSED	327,59	VKVP100FDEFD	479,16	VKVP100FSEFD	516,03
1 1/4"	VKVP114FDED	320,49	VKVP114FSED	347,87	VKVP114FDEFD	499,48	VKVP114FSEFD	536,33
1 1/2"	VKVP112FDED	348,22	VKVP112FSED	428,84	VKVP112FDEFD	527,22	VKVP112FSEFD	617,30
2"	VKVP200FDED	394,38	VKVP200FSED	545,38	VKVP200FDEFD	573,39	VKVP200FSEFD	733,83
2 1/2"	VKVP212FDED	680,81	VKVP212FSED	787,65	VKVP212FDEFD	859,82	VKVP212FSEFD	976,10
3"	VKVP300FDED	791,07	VKVP300FSED	897,90	VKVP300FDEFD	970,06	VKVP300FSEFD	1.086,36
4"	VKVP400FDED	900,50	VKVP400FSED	1.278,58	VKVP400FDEFD	1.079,50	VKVP400FSEFD	1.467,04

Válvula de bola motorizada en PVC-U 2 vías DUAL BLOCK®. Actuación neumática

Disponemos de otras conexiones bajo pedido: bridas, encolar (BS, ASTM, JIS) y roscar (NPT, JIS). Las válvulas neumáticas se configuran NC (normalmente cerrada) de serie. La configuración NA (normalmente abierta) se debe especificar en el pedido.

VKRIV/CP

encolar.

VKRFV/CP

roscar.



K

ACTUACIÓN NEUMÁTICA ALUMINIO DOBLE EFECTO
CON POSICIONADOR 4-20 mAACTUACIÓN NEUMÁTICA ALUMINIO SIMPLE EFECTO
CON POSICIONADOR 4-20 mA

d-Rh	Ref.	€		Ref.	€		Ref.	€		
		EPDM	FKM		EPDM	FKM		EPDM	FKM	
16	VRVP016EDEPD	1.965,96		VRVP016FDEPD	1.973,82		VRVP016ESEPD	1.993,33	VRVP016FSEPD	2.001,21
20	VRVP020EDEPD	1.967,47		VRVP020FDEPD	1.974,99		VRVP020ESEPD	1.994,87	VRVP020FSEPD	2.002,38
25	VRVP025EDEPD	1.988,84		VRVP025FDEPD	1.998,50		VRVP025ESEPD	2.016,22	VRVP025FSEPD	2.025,90
32	VRVP032EDEPD	2.023,18		VRVP032FDEPD	2.035,04		VRVP032ESEPD	2.050,60	VRVP032FSEPD	2.062,44
40	VRVP040EDEPD	2.041,23		VRVP040FDEPD	2.054,17		VRVP040ESEPD	2.068,63	VRVP040FSEPD	2.081,55
50	VRVP050EDEPD	2.108,29		VRVP050FDEPD	2.124,44		VRVP050ESEPD	2.188,90	VRVP050FSEPD	2.205,06
63	VRVP063EDEPD	2.123,27		VRVP063FDEPD	2.155,22		VRVP063ESEPD	2.274,25	VRVP063FSEPD	2.306,20
3/8"	VRVP038EDEPD	1.968,85		VRVP038FDEPD	1.968,85		VRVP038ESEPD	1.996,25	VRVP038FSEPD	1.996,25
1/2"	VRVP012EDEPD	1.970,76		VRVP012FDEPD	1.970,76		VRVP012ESEPD	1.998,15	VRVP012FSEPD	1.998,15
3/4"	VRVP034EDEPD	1.993,29		VRVP034FDEPD	1.993,29		VRVP034ESEPD	2.020,68	VRVP034FSEPD	2.020,68
1"	VRVP100EDEPD	2.027,85		VRVP100FDEPD	2.027,85		VRVP100ESEPD	2.055,23	VRVP100FSEPD	2.055,23
1 1/4"	VRVP114EDEPD	2.048,61		VRVP114FDEPD	2.048,61		VRVP114ESEPD	2.076,00	VRVP114FSEPD	2.076,00
1 1/2"	VRVP112EDEPD	2.119,54		VRVP112FDEPD	2.119,54		VRVP112ESEPD	2.200,15	VRVP112FSEPD	2.200,15
2"	VRVP200EDEPD	2.138,77		VRVP200FDEPD	2.138,77		VRVP200ESEPD	2.289,74	VRVP200FSEPD	2.289,74

Válvula de bola **REGULACIÓN** motorizada en PVC-U 2 vías DUAL BLOCK®.

Actuación neumática con posicionador 4-20 mA

Disponemos de otras conexiones bajo pedido: bridas, encolar (BS, ASTM, JIS) y roscar (NPT, JIS)

Las válvulas neumáticas se configuran NC (normalmente cerrada) de serie. La configuración NA (normalmente abierta) se debe especificar en el pedido

VKRIV/CP

encolar.

VKRFV/CP

roscar.



K

ACTUACIÓN NEUMÁTICA POLIAMIDA DOBLE EFECTO
CON POSICIONADOR 4-20 mAACTUACIÓN NEUMÁTICA POLIAMIDA SIMPLE EFECTO
CON POSICIONADOR 4-20 mA

d-Rh	Ref.	€		Ref.	€		Ref.	€		
		EPDM	FKM		EPDM	FKM		EPDM	FKM	
16	VRVP016EDEPP	1.573,67		VRVP016FDEPP	1.581,53		VRVP016ESEPP	1.594,31	VRVP016FSEPP	1.602,17
20	VRVP020EDEPP	1.575,20		VRVP020FDEPP	1.582,71		VRVP020ESEPP	1.595,85	VRVP020FSEPP	1.603,35
25	VRVP025EDEPP	1.596,57		VRVP025FDEPP	1.606,21		VRVP025ESEPP	1.617,21	VRVP025FSEPP	1.626,85
32	VRVP032EDEPP	1.630,90		VRVP032FDEPP	1.642,77		VRVP032ESEPP	1.744,43	VRVP032FSEPP	1.756,29
40	VRVP040EDEPP	1.648,95		VRVP040FDEPP	1.661,87		VRVP040ESEPP	1.762,46	VRVP040FSEPP	1.775,40
50	VRVP050EDEPP	1.716,00		VRVP050FDEPP	1.732,15		VRVP050ESEPP	1.937,89	VRVP050FSEPP	1.954,03
63	VRVP063EDEPP	1.913,05		VRVP063FDEPP	1.944,98		VRVP063ESEPP	1.972,37	VRVP063FSEPP	2.004,33
3/8"	VRVP038EDEPP	1.576,56		VRVP038FDEPP	1.576,56		VRVP038ESEPP	1.597,20	VRVP038FSEPP	1.597,20
1/2"	VRVP012EDEPP	1.578,45		VRVP012FDEPP	1.578,45		VRVP012ESEPP	1.599,11	VRVP012FSEPP	1.599,11
3/4"	VRVP034EDEPP	1.601,00		VRVP034FDEPP	1.601,00		VRVP034ESEPP	1.621,65	VRVP034FSEPP	1.621,65
1"	VRVP100EDEPP	1.635,55		VRVP100FDEPP	1.635,55		VRVP100ESEPP	1.749,06	VRVP100FSEPP	1.749,06
1 1/4"	VRVP114EDEPP	1.656,30		VRVP114FDEPP	1.656,30		VRVP114ESEPP	1.769,83	VRVP114FSEPP	1.769,83
1 1/2"	VRVP112EDEPP	1.727,25		VRVP112FDEPP	1.727,25		VRVP112ESEPP	1.949,13	VRVP112FSEPP	1.949,13
2"	VRVP200EDEPP	1.928,53		VRVP200FDEPP	1.928,53		VRVP200ESEPP	1.987,86	VRVP200FSEPP	1.987,86

Válvula de bola **REGULACIÓN** motorizada en PVC-U 2 vías DUAL BLOCK®.

Actuación neumática con posicionador 4-20 mA

Disponemos de otras conexiones bajo pedido: bridas, encolar (BS, ASTM, JIS) y roscar (NPT, JIS)

Las válvulas neumáticas se configuran NC (normalmente cerrada) de serie. La configuración NA (normalmente abierta) se debe especificar en el pedido

VKDIV/CP

encolar.

VKDFV/CP

roscar.



K

ACTUACIÓN NEUMÁTICA POLIAMIDA

ACTUACIÓN NEUMÁTICA POLIAMIDA CON ELECTROVÁLVULA, FINALES DE CARRERA (ELECTROMEQUÍNICOS) Y REGULADORES DE ESCAPE

d-Rh	DOBLE EFECTO		SIMPLE EFECTO		DOBLE EFECTO		SIMPLE EFECTO	
	Ref.	€	Ref.	€	Ref.	€	Ref.	€
16	VKVP016EDEP	273,95	VKVP016ESEP	294,62	VKVP016EDEFPP	508,11	VKVP016ESEFP	528,76
20	VKVP020EDEP	275,45	VKVP020ESEP	296,09	VKVP020EDEFPP	509,59	VKVP020ESEFP	530,24
25	VKVP025EDEP	285,03	VKVP025ESEP	305,69	VKVP025EDEFPP	519,20	VKVP025ESEFP	539,84
32	VKVP032EDEP	296,31	VKVP032ESEP	409,84	VKVP032EDEFPP	530,45	VKVP032ESEFP	643,97
40	VKVP040EDEP	316,65	VKVP040ESEP	430,15	VKVP040EDEFPP	550,80	VKVP040ESEFP	664,30
50	VKVP050EDEP	337,09	VKVP050ESEP	558,96	VKVP050EDEFPP	571,23	VKVP050ESEFP	793,12
63	VKVP063EDEP	544,65	VKVP063ESEP	604,00	VKVP063EDEFPP	778,81	VKVP063ESEFP	838,14
75	VKVP075EDEP	705,87	VKVP075ESEP	928,15	VKVP075EDEFPP	940,02	VKVP075ESEFP	1.162,30
90	VKVP090EDEP	794,90	VKVP090ESEP	1.017,20	VKVP090EDEFPP	1.029,05	VKVP090ESEFP	1.251,34
110	VKVP110EDEP	840,76	VKVP110ESEP	1.082,00	VKVP110EDEFPP	1.074,89	VKVP110ESEFP	1.316,15
3/8"	VKVP038EDEP	276,84	VKVP038ESEP	297,49	VKVP038EDEFPP	510,98	VKVP038ESEFP	531,63
1/2"	VKVP012EDEP	278,78	VKVP012ESEP	299,41	VKVP012EDEFPP	512,92	VKVP012ESEFP	533,56
3/4"	VKVP034EDEP	289,54	VKVP034ESEP	310,19	VKVP034EDEFPP	523,69	VKVP034ESEFP	544,33
1"	VKVP100EDEP	300,96	VKVP100ESEP	414,47	VKVP100EDEFPP	535,11	VKVP100ESEFP	648,64
1 1/4"	VKVP114EDEP	323,98	VKVP114ESEP	437,52	VKVP114EDEFPP	558,14	VKVP114ESEFP	671,66
1 1/2"	VKVP112EDEP	348,27	VKVP112ESEP	570,18	VKVP112EDEFPP	582,42	VKVP112ESEFP	804,32
2"	VKVP200EDEP	560,10	VKVP200ESEP	619,42	VKVP200EDEFPP	794,24	VKVP200ESEFP	853,57
2 1/2"	VKVP212EDEP	731,88	VKVP212ESEP	954,17	VKVP212EDEFPP	966,04	VKVP212ESEFP	1.188,31
3"	VKVP300EDEP	828,01	VKVP300ESEP	1.050,31	VKVP300EDEFPP	1.062,18	VKVP300ESEFP	1.284,45
4"	VKVP400EDEP	878,01	VKVP400ESEP	1.119,27	VKVP400EDEFPP	1.112,15	VKVP400ESEFP	1.353,42
16	VKVP016FDEP	281,83	VKVP016FSEP	302,49	VKVP016FDEFPP	515,98	VKVP016FSEFP	536,64
20	VKVP020FDEP	283,00	VKVP020FSEP	303,65	VKVP020FDEFPP	517,16	VKVP020FSEFP	537,81
25	VKVP025FDEP	294,76	VKVP025FSEP	315,42	VKVP025FDEFPP	528,92	VKVP025FSEFP	549,58
32	VKVP032FDEP	308,16	VKVP032FSEP	421,68	VKVP032FDEFPP	542,30	VKVP032FSEFP	655,82
40	VKVP040FDEP	329,57	VKVP040FSEP	443,10	VKVP040FDEFPP	563,72	VKVP040FSEFP	677,24
50	VKVP050FDEP	353,25	VKVP050FSEP	575,13	VKVP050FDEFPP	587,38	VKVP050FSEFP	809,28
63	VKVP063FDEP	576,55	VKVP063FSEP	635,89	VKVP063FDEFPP	810,68	VKVP063FSEFP	870,05
75	VKVP075FDEP	769,91	VKVP075FSEP	992,21	VKVP075FDEFPP	1.004,05	VKVP075FSEFP	1.226,34
90	VKVP090FDEP	872,99	VKVP090FSEP	1.095,29	VKVP090FDEFPP	1.107,14	VKVP090FSEFP	1.329,44
110	VKVP110FDEP	948,55	VKVP110FSEP	1.189,80	VKVP110FDEFPP	1.182,69	VKVP110FSEFP	1.423,95
3/8"	VKVP038FDEP	285,22	VKVP038FSEP	305,86	VKVP038FDEFPP	519,36	VKVP038FSEFP	540,00
1/2"	VKVP012FDEP	286,99	VKVP012FSEP	307,64	VKVP012FDEFPP	521,14	VKVP012FSEFP	541,79
3/4"	VKVP034FDEP	297,53	VKVP034FSEP	318,18	VKVP034FDEFPP	531,67	VKVP034FSEFP	552,32
1"	VKVP100FDEP	316,90	VKVP100FSEP	430,42	VKVP100FDEFPP	551,06	VKVP100FSEFP	664,57
1 1/4"	VKVP114FDEP	337,20	VKVP114FSEP	450,72	VKVP114FDEFPP	571,34	VKVP114FSEFP	684,87
1 1/2"	VKVP112FDEP	364,94	VKVP112FSEP	586,82	VKVP112FDEFPP	599,09	VKVP112FSEFP	820,98
2"	VKVP200FDEP	593,17	VKVP200FSEP	652,49	VKVP200FDEFPP	827,30	VKVP200FSEFP	886,65
2 1/2"	VKVP212FDEP	795,94	VKVP212FSEP	1.018,19	VKVP212FDEFPP	1.030,08	VKVP212FSEFP	1.252,35
3"	VKVP300FDEP	906,17	VKVP300FSEP	1.128,46	VKVP300FDEFPP	1.140,32	VKVP300FSEFP	1.362,59
4"	VKVP400FDEP	985,82	VKVP400FSEP	1.227,07	VKVP400FDEFPP	1.219,96	VKVP400FSEFP	1.461,23

Válvula de bola motorizada en PVC-U 2 vías DUAL BLOCK®. Actuación neumática

Disponemos de otras conexiones bajo pedido: bridas, encolar (BS, ASTM, JIS) y roscar (NPT, JIS). Las válvulas neumáticas se configuran NC (normalmente cerrada) de serie. La configuración NA (normalmente abierta) se debe especificar en el pedido.



LKDIV/CE

encolar.

LKDFV/CE

roscar.

K

ACTUACIÓN ELÉCTRICA

ACTUACIÓN ELÉCTRICA CON BLOQUE DE SEGURIDAD

d-Rh	24-240 V AC/DC		24-240 V AC/DC		24-240 V AC/DC		24-240 V AC/DC	
	Ref.	€ EPDM	Ref.	€ FKM	Ref.	€ EPDM	Ref.	€ FKM
16	LKVE016E2D	624,43	LKVE016F2D	637,89	LKVE016E2BD	1.119,32	LKVE016F2BD	1.132,75
20	LKVE020E2D	626,58	LKVE020F2D	640,29	LKVE020E2BD	1.121,46	LKVE020F2BD	1.135,17
25	LKVE025E2D	645,74	LKVE025F2D	664,07	LKVE025E2BD	1.140,64	LKVE025F2BD	1.158,92
32	LKVE032E2D	675,00	LKVE032F2D	697,68	LKVE032E2BD	1.169,86	LKVE032F2BD	1.192,57
40	LKVE040E2D	712,66	LKVE040F2D	745,53	LKVE040E2BD	1.207,55	LKVE040F2BD	1.240,41
50	LKVE050E2D	750,63	LKVE050F2D	805,73	LKVE050E2BD	1.245,52	LKVE050F2BD	1.300,61
63	LKVE063E2D	811,51	LKVE063F2D	881,07	LKVE063E2BD	1.306,39	LKVE063F2BD	1.375,94
3/8"	LKVE038E2D	633,83	LKVE038F2D	647,29	LKVE038E2BD	1.128,73	LKVE038F2BD	1.142,15
1/2"	LKVE012E2D	636,15	LKVE012F2D	649,90	LKVE012E2BD	1.131,03	LKVE012F2BD	1.144,76
3/4"	LKVE034E2D	656,79	LKVE034F2D	675,10	LKVE034E2BD	1.151,67	LKVE034F2BD	1.169,99
1"	LKVE100E2D	688,68	LKVE100F2D	711,37	LKVE100E2BD	1.183,55	LKVE100F2BD	1.206,27
1 1/4"	LKVE114E2D	729,29	LKVE114F2D	762,09	LKVE114E2BD	1.224,16	LKVE114F2BD	1.256,98
1 1/2"	LKVE112E2D	770,69	LKVE112F2D	825,82	LKVE112E2BD	1.265,54	LKVE112F2BD	1.320,70
2"	LKVE200E2D	836,82	LKVE200F2D	906,33	LKVE200E2BD	1.331,69	LKVE200F2BD	1.401,21

Válvula de bola motorizada en PVC-U 3 vías DUAL BLOCK®.

Estándar paso en L, paso en T opcional, al mismo precio. Bajo pedido podemos suministrar otros actuadores: VALPES, BELIMO...

Disponemos de otras conexiones bajo pedido: bridas, encolar (BS, ASTM, JIS) y roscar (NPT, JIS)

Actuación eléctrica

Bajo pedido también disponibles en 12V AC/DC



Medida	Ref. EPDM	DN	PN	M1 €
140	63072	125	10	1.410,27

Válvula Ø 140 con actuador neumático.

Brida.

Medida	Ref. EPDM	DN	PN	M1 €
140	63073	125	10	2.206,56

Válvula Ø 140 con actuador eléctrico.

Brida.

**LKDIV/CP**

encolar.

LKDFV/CP

roscar.

ACTUACIÓN NEUMÁTICA ALUMINIO

ACTUACIÓN NEUMÁTICA ALUMINIO CON ELECTROVÁLVULA, FINALES DE CARRERA (ELECTROMECÁNICOS) Y REGULADORES DE ESCAPE

d-Rh	DOBLE EFECTO		SIMPLE EFECTO		DOBLE EFECTO		SIMPLE EFECTO	
	Ref.	€	Ref.	€	Ref.	€	Ref.	€
ENCOLAR EPDM	16	LKVP016EDED 350,90	LKVP016ESED 350,84	LKVP016EDEFD 502,44	LKVP016ESEFD 539,29			
	20	LKVP020EDED 325,57	LKVP020ESED 353,00	LKVP020EDEFD 504,59	LKVP020ESEFD 541,43			
	25	LKVP025EDED 344,77	LKVP025ESED 372,15	LKVP025EDEFD 523,74	LKVP025ESEFD 560,61			
	32	LKVP032EDED 373,99	LKVP032ESED 401,39	LKVP032EDEFD 552,99	LKVP032ESEFD 589,83			
	40	LKVP040EDED 411,65	LKVP040ESED 492,27	LKVP040EDEFD 590,64	LKVP040ESEFD 680,72			
	50	LKVP050EDED 481,54	LKVP050ESED 600,63	LKVP050EDEFD 660,53	LKVP050ESEFD 789,06			
63	LKVP063EDED 542,40	LKVP063ESED 661,49	LKVP063EDEFD 721,39	LKVP063ESEFD 849,94				
ROSCAR EPDM	3/8"	LKVP038EDED 332,83	LKVP038ESED 360,24	LKVP038EDEFD 511,83	LKVP038ESEFD 548,68			
	1/2"	LKVP012EDED 335,13	LKVP012ESED 362,55	LKVP012EDEFD 514,14	LKVP012ESEFD 550,98			
	3/4"	LKVP034EDED 355,78	LKVP034ESED 383,19	LKVP034EDEFD 534,78	LKVP034ESEFD 571,64			
	1"	LKVP100EDED 387,69	LKVP100ESED 415,09	LKVP100EDEFD 566,69	LKVP100ESEFD 603,54			
	1 1/4"	LKVE114EDED 428,27	LKVP114ESED 508,89	LKVP114EDEFD 607,27	LKVP114ESEFD 697,35			
	1 1/2"	LKVP112EDED 501,58	LKVP112ESED 620,67	LKVP112EDEFD 680,56	LKVP112ESEFD 809,10			
2"	LKVP200EDED 567,71	LKVP200ESED 686,82	LKVP200EDEFD 746,72	LKVP200ESEFD 875,25				
ENCOLAR FKM	16	LKVP016FDED 336,88	LKVP016FSED 364,29	LKVP016FDEFD 515,87	LKVP016FSEFD 552,74			
	20	LKVP020FDED 339,28	LKVP020FSED 366,68	LKVP020FDEFD 518,29	LKVP020FSEFD 555,14			
	25	LKVP025FDED 363,06	LKVP025FSED 390,44	LKVP025FDEFD 542,06	LKVP025FSEFD 578,90			
	32	LKVP032FDED 396,68	LKVP032FSED 424,07	LKVP032FDEFD 575,68	LKVP032FSEFD 612,52			
	40	LKVP040FDED 444,54	LKVP040FSED 525,14	LKVP040FDEFD 623,54	LKVP040FSEFD 713,60			
	50	LKVP050FDED 536,64	LKVP050FSED 655,73	LKVP050FDEFD 715,62	LKVP050FSEFD 844,17			
63	LKVP063FDED 611,96	LKVP063FSED 731,06	LKVP063FDEFD 790,97	LKVP063FSEFD 919,52				
ROSCAR FKM	3/8"	LKVP038FDED 346,28	LKVP038FSED 373,69	LKVP038FDEFD 525,28	LKVP038FSEFD 562,15			
	1/2"	LKVP012FDED 348,89	LKVP012FSED 376,28	LKVP012FDEFD 527,90	LKVP012FSEFD 564,74			
	3/4"	LKVP034FDED 374,08	LKVP034FSED 401,49	LKVP034FDEFD 553,09	LKVP034FSEFD 589,93			
	1"	LKVP100FDED 410,38	LKVP100FSED 437,78	LKVP100FDEFD 589,37	LKVP100FSEFD 626,23			
	1 1/4"	LKVE114FDED 461,10	LKVP114FSED 541,71	LKVP114FDEFD 640,08	LKVP114FSEFD 730,13			
	1 1/2"	LKVP112FDED 556,72	LKVP112FSED 675,82	LKVP112FDEFD 735,72	LKVP112FSEFD 864,26			
2"	LKVP200FDED 637,22	LKVP200FSED 756,31	LKVP200FDEFD 816,21	LKVP200FSEFD 944,75				

Válvula de bola motorizada en PVC-U 3 vías DUAL BLOCK®. Actuación neumática

Estándar paso en L, paso en T opcional, al mismo precio. Disponemos de otras conexiones bajo pedido: bridas, encolar (BS, ASTM, JIS) y roscar (NPT, JIS). Las válvulas neumáticas se configuran NC (normalmente cerrada) de serie. La configuración NA (normalmente abierta) se debe especificar en el pedido.

**LKDIV/CP**

encolar.

LKDFV/CP

roscar.

ACTUACIÓN NEUMÁTICA POLIAMIDA

ACTUACIÓN NEUMÁTICA POLIAMIDA CON ELECTROVÁLVULA, FINALES DE CARRERA (ELECTROMECÁNICOS) Y REGULADORES DE ESCAPE

d-Rh	DOBLE EFECTO		SIMPLE EFECTO		DOBLE EFECTO		SIMPLE EFECTO		
	Ref.	€	Ref.	€	Ref.	€	Ref.	€	
ENCOLAR EPDM	16	LKVP016EDEP	375,32	LKVP016ESEP	395,97	LKVP016EDEFPP	609,47	LKVP016ESEFP	630,13
	20	LKVP020EDEP	377,46	LKVP020ESEP	398,12	LKVP020EDEFPP	611,60	LKVP020ESEFP	632,28
	25	LKVP025EDEP	436,97	LKVP025ESEP	457,62	LKVP025EDEFPP	671,11	LKVP025ESEFP	691,75
	32	LKVP032EDEP	466,19	LKVP032ESEP	579,71	LKVP032EDEFPP	700,35	LKVP032ESEFP	813,88
	40	LKVP040EDEP	517,16	LKVP040ESEP	739,03	LKVP040EDEFPP	751,32	LKVP040ESEFP	973,17
	50	LKVP050EDEP	638,10	LKVP050ESEP	774,80	LKVP050EDEFPP	872,24	LKVP050ESEFP	1.008,96
63	LKVP063EDEP	766,90	LKVP063ESEP	826,23	LKVP063EDEFPP	1.001,04	LKVP063ESEFP	1.060,39	
ROSCAR EPDM	3/8"	LKVP038EDEP	384,73	LKVP038ESEP	405,37	LKVP038EDEFPP	618,86	LKVP038ESEFP	639,51
	1/2"	LKVP012EDEP	387,03	LKVP012ESEP	407,68	LKVP012EDEFPP	621,17	LKVP012ESEFP	641,82
	3/4"	LKVP034EDEP	448,01	LKVP034ESEP	468,64	LKVP034EDEFPP	682,14	LKVP034ESEFP	702,79
	1"	LKVP100EDEP	479,90	LKVP100ESEP	593,42	LKVP100EDEFPP	714,05	LKVP100ESEFP	827,57
	1 1/4"	LKVP114EDEP	533,76	LKVP114ESEP	755,65	LKVP114EDEFPP	767,91	LKVP114ESEFP	989,79
	1 1/2"	LKVP112EDEP	658,13	LKVP112ESEP	794,85	LKVP112EDEFPP	892,29	LKVP112ESEFP	1.028,99
2"	LKVP200EDEP	792,19	LKVP200ESEP	851,54	LKVP200EDEFPP	1.026,36	LKVP200ESEFP	1.085,68	
ENCOLAR FKM	16	LKVP016FDEP	388,76	LKVP016FSEP	409,42	LKVP016FDEFPP	622,91	LKVP016FSEFP	643,57
	20	LKVP020FDEP	391,17	LKVP020FSEP	411,83	LKVP020FDEFPP	625,31	LKVP020FSEFP	645,97
	25	LKVP025FDEP	455,25	LKVP025FSEP	475,90	LKVP025FDEFPP	689,41	LKVP025FSEFP	710,06
	32	LKVP032FDEP	488,89	LKVP032FSEP	602,40	LKVP032FDEFPP	723,05	LKVP032FSEFP	836,56
	40	LKVP040FDEP	550,02	LKVP040FSEP	771,92	LKVP040FDEFPP	784,18	LKVP040FSEFP	1.006,04
	50	LKVP050FDEP	693,19	LKVP050FSEP	829,92	LKVP050FDEFPP	927,34	LKVP050FSEFP	1.064,06
63	LKVP063FDEP	836,47	LKVP063FSEP	895,80	LKVP063FDEFPP	1.070,63	LKVP063FSEFP	1.129,95	
ROSCAR FKM	3/8"	LKVP038FDEP	398,17	LKVP038FSEP	418,80	LKVP038FDEFPP	632,32	LKVP038FSEFP	652,97
	1/2"	LKVP012FDEP	400,77	LKVP012FSEP	421,43	LKVP012FDEFPP	634,92	LKVP012FSEFP	655,57
	3/4"	LKVP034FDEP	466,30	LKVP034FSEP	486,96	LKVP034FDEFPP	700,44	LKVP034FSEFP	721,11
	1"	LKVP100FDEP	502,59	LKVP100FSEP	616,12	LKVP100FDEFPP	736,73	LKVP100FSEFP	850,25
	1 1/4"	LKVP114FDEP	566,57	LKVP114FSEP	788,46	LKVP114FDEFPP	800,72	LKVP114FSEFP	1.022,60
	1 1/2"	LKVP112FDEP	713,28	LKVP112FSEP	849,99	LKVP112FDEFPP	947,43	LKVP112FSEFP	1.084,15
2"	LKVP200FDEP	861,70	LKVP200FSEP	921,06	LKVP200FDEFPP	1.095,85	LKVP200FSEFP	1.155,19	

Válvula de bola motorizada en PVC-U 3 vías DUAL BLOCK®.

Actuación neumática

Estándar paso en L, paso en T opcional, al mismo precio. Disponemos de otras conexiones bajo pedido: bridas, encolar (BS, ASTM, JIS) y roscar (NPT, JIS)

Las válvulas neumáticas se configuran NC (normalmente cerrada) de serie.

La configuración NA (normalmente abierta) se debe especificar en el pedido

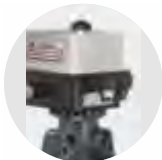

K

FEOV/CE

ACTUACIÓN ELÉCTRICA

ACTUACIÓN ELÉCTRICA CON BLOQUE DE SEGURIDAD

d	24-240 V AC/DC		24-240 V AC/DC		24-240 V AC/DC		24-240 V AC/DC	
	Ref.	€ EPDM	Ref.	€ FKM	Ref.	€ EPDM	Ref.	€ FKM
50	FEVE050E2D	594,35	FEVE050F2D	681,90	FEVE050E2BD	1.089,21	FEVE050F2BD	1.176,77
63	FEVE063E2D	599,45	FEVE063F2D	692,53	FEVE063E2BD	1.094,32	FEVE063F2BD	1.187,40
75	FEVE075E2D	835,14	FEVE075F2D	926,62	FEVE075E2BD	1.330,00	FEVE075F2BD	1.421,49
90	FEVE090E2D	849,30	FEVE090F2D	970,12	FEVE090E2BD	1.344,16	FEVE090F2BD	1.464,99
110	FEVE110E2D	868,55	FEVE110F2D	1.026,14	FEVE110E2BD	1.363,42	FEVE110F2BD	1.521,01
125 (A1)	FEVE140E2D	1.217,30	FEVE140F2D	1.445,93	FEVE140E2BD	1.712,19	FEVE140F2BD	1.940,81
140	FEVE140E2D	1.217,30	FEVE140F2D	1.445,93	FEVE140E2BD	1.712,19	FEVE140F2BD	1.940,81
160	FEVE160E2D	1.472,30	FEVE160F2D	1.835,95	FEVE160E2BD	2.051,41	FEVE160F2BD	2.415,06
200*(A2)	FEVE225E2D	1.727,75	FEVE225F2D	2.198,61	FEVE225E2BD	2.306,86	FEVE225F2BD	2.777,71
225*	FEVE225E2D	1.727,75	FEVE225F2D	2.198,61	FEVE225E2BD	2.306,86	FEVE225F2BD	2.777,71
250*(A3)	FEVE280E2D	2.454,25			FEVE280E2BD	3.033,34		
280	FEVE280E2D	2.454,25			FEVE280E2BD	3.033,34		
315	FEVE315E2D	2.696,20			FEVE315E2BD	3.275,31		

Válvula de mariposa motorizada en PVC-U

Actuación eléctrica

(A1) = a utilizar con portabridas QPV especial no incluido (transforma la válvula de mariposa de 140 en 125)

(A2) = a utilizar con portabridas QPV especial no incluido (transforma la válvula de mariposa de 225 en 200)

(A3) = a utilizar con tubo de diámetro 250 SDR 26 (PN10)

Bajo pedido podemos suministrar otros actuadores: VALPES, BELIMO... [Bajo pedido también disponibles en 12V AC/DC](#)



K

FEOV/CP
ACTUACIÓN NEUMÁTICA ALUMINIO
ACTUACIÓN NEUMÁTICA ALUMINIO CON ELECTROVÁLVULA, FINALES DE CARRERA (ELECTROMECAÑICOS) Y REGULADORES DE ESCAPE

d	DOBLE EFECTO		SIMPLE EFECTO		DOBLE EFECTO		SIMPLE EFECTO	
	Ref.	€	Ref.	€	Ref.	€	Ref.	€
50	FEVP050EDED	293,04	FEVP050ESED	373,65	FEVP050EDEFD	472,05	FEVP050ESEFD	562,09
63	FEVP063EDED	298,13	FEVP063ESED	378,76	FEVP063EDEFD	477,13	FEVP063ESEFD	567,22
75	FEVP075EDED	334,08	FEVP075ESED	453,17	FEVP075EDEFD	513,05	FEVP075ESEFD	641,62
90	FEVP090EDED	404,04	FEVP090ESED	510,86	FEVP090EDEFD	583,05	FEVP090ESEFD	699,32
110	FEVP110EDED	423,32	FEVP110ESED	825,48	FEVP110EDEFD	602,32	FEVP110ESEFD	1.013,93
125 (A1)	FEVP140EDED	474,84	FEVP140ESED	1.079,19	FEVP140EDEFD	653,82	FEVP140ESEFD	1.267,65
140	FEVP140EDED	474,84	FEVP140ESED	1.079,19	FEVP140EDEFD	653,82	FEVP140ESEFD	1.267,65
160	FEVP160EDED	513,98	FEVP160ESED	1.118,34	FEVP160EDEFD	692,98	FEVP160ESEFD	1.306,80
200 (A2)	FEVP225EDED	893,40	FEVP225ESED	1.722,85	FEVP225EDEFD	1.072,40	FEVP225ESEFD	1.911,31
225	FEVP225EDED	893,40	FEVP225ESED	1.722,85	FEVP225EDEFD	1.072,40	FEVP225ESEFD	1.911,31
250 (A3)	FEVP280EDED	1.781,27	FEVP280ESED	3.539,73	FEVP280EDEFD	1.960,28	FEVP280ESEFD	3.728,22
280	FEVP280EDED	1.781,27	FEVP280ESED	3.539,73	FEVP280EDEFD	1.960,28	FEVP280ESEFD	3.728,22
315	FEVP315EDED	2.262,41	FEVP315ESED	4.690,15	FEVP315EDEFD	2.441,39	FEVP315ESEFD	4.878,61
50	FEVP050FDED	380,58	FEVP050FSED	461,19	FEVP050FDEFD	559,59	FEVP050FSEFD	649,65
63	FEVP063FDED	391,21	FEVP063FSED	471,82	FEVP063FDEFD	570,22	FEVP063FSEFD	660,27
75	FEVP075FDED	425,57	FEVP075FSED	544,65	FEVP075FDEFD	604,57	FEVP075FSEFD	733,10
90	FEVP090FDED	524,86	FEVP090FSED	631,71	FEVP090FDEFD	703,87	FEVP090FSEFD	820,15
110	FEVP110FDED	580,90	FEVP110FSED	983,04	FEVP110FDEFD	759,89	FEVP110FSEFD	1.171,51
125 (A1)	FEVP140FDED	703,48	FEVP140FSED	1.307,83	FEVP140FDEFD	882,45	FEVP140FSEFD	1.496,29
140	FEVP140FDED	703,48	FEVP140FSED	1.307,83	FEVP140FDEFD	882,45	FEVP140FSEFD	1.496,29
160	FEVP160FDED	877,68	FEVP160FSED	1.482,02	FEVP160FDEFD	1.056,65	FEVP160FSEFD	1.670,47
200 (A2)	FEVP225FDED	1.364,23	FEVP225FSED	2.193,70	FEVP225FDEFD	1.543,24	FEVP225FSEFD	2.382,16
225	FEVP225FDE	1.364,23	FEVP225FSED	2.193,70	FEVP225FDEFD	1.543,24	FEVP225FSEFD	2.382,16

Válvula de mariposa motorizada en PVC-U

Actuación neumática

(A1) = a utilizar con portabridas QPV especial no incluido (transforma la válvula de mariposa de 140 en 125)

(A2) = a utilizar con portabridas QPV especial no incluido (transforma la válvula de mariposa de 225 en 200)

(A3) = a utilizar con tubo de diámetro 250 SDR 26 (PN10)

 Las válvulas neumáticas se configuran NC (normalmente cerrada) de serie.
 La configuración NA (normalmente abierta) se debe especificar en el pedido

FEOV/CP

K

ACTUACIÓN NEUMÁTICA POLIAMIDA
ACTUACIÓN NEUMÁTICA POLIAMIDA CON ELECTROVÁLVULA, FINALES DE CARRERA (ELECTROMECAÑICOS) Y REGULADORES DE ESCAPE

d	DOBLE EFECTO		SIMPLE EFECTO		DOBLE EFECTO		SIMPLE EFECTO	
	Ref.	€	Ref.	€	Ref.	€	Ref.	€
50	FEVP050EDEP	388,45	FEVP050ESEP	534,03	FEVP050EDEFPP	622,60	FEVP050ESEFP	768,16
63	FEVP063EDEP	393,56	FEVP063ESEP	539,13	FEVP063EDEFPP	627,71	FEVP063ESEFP	773,28
75	FEVP075EDEP	397,62	FEVP075ESEP	543,18	FEVP075EDEFPP	631,76	FEVP075ESEFP	777,32
90	FEVP090EDEP	497,69	FEVP090ESEP	557,02	FEVP090EDEFPP	731,84	FEVP090ESEFP	791,16
110	FEVP110EDEP	516,95	FEVP110ESEP	750,49	FEVP110EDEFPP	751,10	FEVP110ESEFP	984,66
125 (A1)	FEVP140EDEP	531,63	FEVP140ESEP	1.032,94	FEVP140EDEFPP	765,78	FEVP140ESEFP	1.267,10
140	FEVP140EDEP	531,63	FEVP140ESEP	1.032,94	FEVP140EDEFPP	765,78	FEVP140ESEFP	1.267,10
160	FEVP160EDEP	734,58	FEVP160ESEP	1.072,08	FEVP160EDEFPP	968,73	FEVP160ESEFP	1.306,22
200 (A2)	FEVP225EDEP	876,77	FEVP225ESEP	1.573,30	FEVP225EDEFPP	1.110,91	FEVP225ESEFP	1.807,46
225	FEVP225EDEP	876,77	FEVP225ESEP	1.573,30	FEVP225EDEFPP	1.110,91	FEVP225ESEFP	1.807,46
250*(A3)	FEVP280EDEP	1.940,70	FEVP280ESEP	3.433,78	FEVP280EDEFPP	2.174,82	FEVP280ESEFP	3.667,94
280*	FEVP280EDEP	1.940,70	FEVP280ESEP	3.433,78	FEVP280EDEFPP	2.174,82	FEVP280ESEFP	3.667,94
315*	FEVP315EDEP	2.182,66	FEVP315ESEP	3.675,76	FEVP315EDEFPP	2.416,82	FEVP315ESEFP	3.909,90
		€		€		€		€
50	FEVP050FDEP	476,01	FEVP050FSEP	621,58	FEVP050FDEFPP	710,15	FEVP050FSEFP	855,74
63	FEVP063FDEP	486,65	FEVP063FSEP	632,22	FEVP063FDEFPP	720,80	FEVP063FSEFP	866,37
75	FEVP075FDEP	489,09	FEVP075FSEP	634,66	FEVP075FDEFPP	723,24	FEVP075FSEFP	868,81
90	FEVP090FDEP	618,52	FEVP090FSEP	677,87	FEVP090FDEFPP	852,67	FEVP090FSEFP	912,00
110	FEVP110FDEP	674,52	FEVP110FSEP	908,05	FEVP110FDEFPP	908,67	FEVP110FSEFP	1.142,20
125 (A1)	FEVP140FDEP	760,24	FEVP140FSEP	1.261,57	FEVP140FDEFPP	994,39	FEVP140FSEFP	1.495,70
140	FEVP140FDEP	760,24	FEVP140FSEP	1.261,57	FEVP140FDEFPP	994,39	FEVP140FSEFP	1.495,70
160	FEVP160FDEP	1.098,25	FEVP160FSEP	1.435,76	FEVP160FDEFPP	1.332,40	FEVP160FSEFP	1.669,92
200 (A2)	FEVP225FDEP	1.347,61	FEVP225FSEP	2.044,14	FEVP225FDEFPP	1.581,77	FEVP225FSEFP	2.278,29
225	FEVP225FDEP	1.347,61	FEVP225FSEP	2.044,14	FEVP225FDEFPP	1.581,77	FEVP225FSEFP	2.278,29

Válvula de mariposa motorizada en PVC-U

Actuación neumática

(A1) = a utilizar con portabridas QPV especial no incluido (transforma la válvula de mariposa de 140 en 125)

(A2) = a utilizar con portabridas QPV especial no incluido (transforma la válvula de mariposa de 225 en 200)

(A3) = a utilizar con tubo de diámetro 250 SDR 26 (PN10) * Actuadores de aluminio

Las válvulas neumáticas se configuran NC (normalmente cerrada) de serie.

La configuración NA (normalmente abierta) se debe especificar en el pedido



K

FKOV/CE

ACTUACIÓN ELÉCTRICA

ACTUACIÓN ELÉCTRICA CON BLOQUE DE SEGURIDAD

d	24-240 V AC/DC		24-240 V AC/DC		24-240 V AC/DC		24-240 V AC/DC	
	Ref.	€ EPDM	Ref.	€ FKM	Ref.	€ EPDM	Ref.	€ FKM
50	FKVE050E2D	753,90	FKVE050F2D	902,53	FKVE050E2BD	1.248,78	FKVE050F2BD	1.397,42
63	FKVE063E2D	769,45	FKVE063F2D	926,82	FKVE063E2BD	1.264,32	FKVE063F2BD	1.421,70
75	FKVE075E2D	1.032,16	FKVE075F2D	1.207,04	FKVE075E2BD	1.527,04	FKVE075F2BD	1.701,87
90	FKVE090E2D	1.059,40	FKVE090F2D	1.242,05	FKVE090E2BD	1.554,28	FKVE090F2BD	1.736,90
110	FKVE110E2D	1.087,82	FKVE110F2D	1.284,76	FKVE110E2BD	1.582,71	FKVE110F2BD	1.779,62
125 (A1)	FKVE140E2D	1.534,77	FKVE140F2D	1.801,62	FKVE140E2BD	2.029,62	FKVE140F2BD	2.296,50
140	FKVE140E2D	1.534,77	FKVE140F2D	1.801,62	FKVE140E2BD	2.029,62	FKVE140F2BD	2.296,50
160	FKVE160E2D	1.802,43	FKVE160F2D	2.078,33	FKVE160E2BD	2.381,54	FKVE160F2BD	2.657,44
200(A2)	FKVE225E2D	2.088,82	FKVE225F2D	2.448,95	FKVE225E2BD	2.667,92	FKVE225F2BD	3.028,06
225	FKVE225E2D	2.088,82	FKVE225F2D	2.448,95	FKVE225E2BD	2.667,92	FKVE225F2BD	3.028,06
250(A3)	FKVE280E2D	3.680,32	FKVE280F2D	5.190,96	FKVE280E2BD	4.259,42	FKVE280F2BD	5.770,05
280	FKVE280E2D	3.680,32	FKVE280F2D	5.190,96	FKVE280E2BD	4.259,42	FKVE280F2BD	5.770,05
315	FKVE315E2D	3.881,14	FKVE315F2D	5.527,84	FKVE315E2BD	4.460,25	FKVE315F2BD	6.106,94
355	FKVE355E2D	9.829,57	FKVE355F2D	13.361,84				
400	FKVE400E2D	10.894,09	FKVE400F2D	15.996,69				

Válvula de mariposa industrial motorizada.

Cuerpo en PPGR y disco en PVC-U

Actuación eléctrica

(A1) = a utilizar con portabridas OPV especial no incluido (transforma la válvula de mariposa de 140 en 125)

(A2) = a utilizar con portabridas QPV especial no incluido (transforma la válvula de mariposa de 225 en 200)

(A3) = a utilizar con tubo de diámetro 250 SDR 26 (PN10)

Bajo pedido podemos suministrar otros actuadores: VALPES, BELIMO...

[Bajo pedido también disponibles en 12V AC/DC](#)

FKOV/CP

K

ACTUACIÓN NEUMÁTICA ALUMINIO
ACTUACIÓN NEUMÁTICA ALUMINIO CON ELECTROVÁLVULA, FINALES DE CARRERA (ELECTROMECÁNICOS) Y REGULADORES DE ESCAPE

d	DOBLE EFECTO		SIMPLE EFECTO		DOBLE EFECTO		SIMPLE EFECTO	
	Ref.	€	Ref.	€	Ref.	€	Ref.	€
50	FKVP050EDED	452,61	FKVP050ESED	533,21	FKVP050EDEFD	631,59	FKVP050ESEFD	721,67
63	FKVP063EDED	468,16	FKVP063ESED	548,75	FKVP063EDEFD	647,14	FKVP063ESEFD	737,20
75	FKVP075EDED	531,11	FKVP075ESED	650,20	FKVP075EDEFD	710,10	FKVP075ESEFD	838,64
90	FKVP090EDED	614,16	FKVP090ESED	720,99	FKVP090EDEFD	793,16	FKVP090ESEFD	909,45
110	FKVP110EDED	642,58	FKVP110ESED	1.044,75	FKVP110EDEFD	821,58	FKVP110ESEFD	1.233,20
125 (A1)	FKVP140EDED	792,29	FKVP140ESED	1.396,66	FKVP140EDEFD	971,30	FKVP140ESEFD	1.585,11
140	FKVP140EDED	792,29	FKVP140ESED	1.396,66	FKVP140EDEFD	971,30	FKVP140ESEFD	1.585,11
160	FKVP160EDED	844,12	FKVP160ESED	1.448,47	FKVP160EDEFD	1.023,12	FKVP160ESEFD	1.636,92
200 (A2)	FKVP225EDED	1.254,45	FKVP225ESED	2.083,89	FKVP225EDEFD	1.433,44	FKVP225ESEFD	2.272,36
225	FKVP225EDED	1.254,45	FKVP225ESED	2.083,89	FKVP225EDEFD	1.433,44	FKVP225ESEFD	2.272,36
250 (A3)	FKVP280EDED	3.007,37	FKVP280ESED	4.765,85	FKVP280EDEFD	3.186,35	FKVP280ESEFD	4.954,31
280	FKVP280EDED	3.007,37	FKVP280ESED	4.765,85	FKVP280EDEFD	3.186,35	FKVP280ESEFD	4.954,31
315	FKVP315EDED	3.447,35	FKVP315ESED	5.875,09	FKVP315EDEFD	3.626,35	FKVP315ESEFD	6.063,54
355	FKVP355EDED	5.607,89	FKVP355ESED	7.437,39				
400	FKVP400EDED	6.193,64	FKVP400ESED	9.674,72				

50	FKVP050FDED	601,24	FKVP050FSED	681,84	FKVP050FDEFD	780,22	FKVP050FSEFD	870,29
63	FKVP063FDED	625,53	FKVP063FSED	706,13	FKVP063FDEFD	804,51	FKVP063FSEFD	894,57
75	FKVP075FDED	705,96	FKVP075FSED	825,07	FKVP075FDEFD	884,96	FKVP075FSEFD	1.013,52
90	FKVP090FDED	796,79	FKVP090FSED	903,63	FKVP090FDEFD	975,79	FKVP090FSEFD	1.092,07
110	FKVP110FDED	839,54	FKVP110FSED	1.241,69	FKVP110FDEFD	1.018,53	FKVP110FSEFD	1.430,14
125 (A1)	FKVP140FDED	1.059,17	FKVP140FSED	1.663,51	FKVP140FDEFD	1.238,14	FKVP140FSEFD	1.851,97
140	FKVP140FDED	1.059,17	FKVP140FSED	1.663,51	FKVP140FDEFD	1.238,14	FKVP140FSEFD	1.851,97
160	FKVP160FDED	1.120,04	FKVP160FSED	1.724,39	FKVP160FDEFD	1.299,03	FKVP160FSEFD	1.912,84
200 (A2)	FKVP225FDED	1.614,60	FKVP225FSED	2.444,05	FKVP225FDEFD	1.793,60	FKVP225FSEFD	2.632,50
225	FKVP225FDED	1.614,60	FKVP225FSED	2.444,05	FKVP225FDEFD	1.793,60	FKVP225FSEFD	2.632,50
250 (A3)	FKVP280FDED	4.518,00	FKVP280FSED	6.276,46	FKVP280FDEFD	4.697,00	FKVP280FSEFD	6.464,92
280	FKVP280FDED	4.518,00	FKVP280FSED	6.276,46	FKVP280FDEFD	4.697,00	FKVP280FSEFD	6.464,92
315	FKVP315FDED	5.094,05	FKVP315FSED	7.521,79	FKVP315FDEFD	5.273,04	FKVP315FSEFD	7.710,23
355	FKVP355FDED	9.140,14	FKVP355FSED	10.969,66				
400	FKVP400FDED	11.296,26	FKVP400FSED	14.777,32				

Válvula de mariposa industrial motorizada.
Cuerpo en PPGR y disco en PVC-U
Actuación neumática

(A1) = a utilizar con portabridas QPV especial no incluido (transforma la válvula de mariposa de 140 en 125)

(A2) = a utilizar con portabridas QPV especial no incluido (transforma la válvula de mariposa de 225 en 200)

(A3) = a utilizar con tubo de diámetro 250 SDR 26 (PN10)

Las válvulas neumáticas se configuran NC (normalmente cerrada) de serie.

La configuración NA (normalmente abierta) se debe especificar en el pedido



FKOV/CP

K

ACTUACIÓN NEUMÁTICA POLIAMIDA

ACTUACIÓN NEUMÁTICA POLIAMIDA CON ELECTROVÁLVULA, FINALES DE CARRERA (ELECTROMECÁNICOS) Y REGULADORES DE ESCAPE

d	DOBLE EFECTO		SIMPLE EFECTO		DOBLE EFECTO		SIMPLE EFECTO	
	Ref.	€	Ref.	€	Ref.	€	Ref.	€
50	FKVP050EDEP	548,02	FKVP050ESEP	693,62	FKVP050EDEFK	782,18	FKVP050ESEFK	927,76
63	FKVP063EDEP	563,57	FKVP063ESEP	709,14	FKVP063EDEFK	797,70	FKVP063ESEFK	943,29
75	FKVP075EDEP	594,65	FKVP075ESEP	740,21	FKVP075EDEFK	828,80	FKVP075ESEFK	974,34
90	FKVP090EDEP	707,81	FKVP090ESEP	767,15	FKVP090EDEFK	941,95	FKVP090ESEFK	1.001,30
110	FKVP110EDEP	736,23	FKVP110ESEP	969,76	FKVP110EDEFK	970,37	FKVP110ESEFK	1.203,92
125 (A1)	FKVP140EDEP	849,07	FKVP140ESEP	1.350,39	FKVP140EDEFK	1.083,23	FKVP140ESEFK	1.584,54
140	FKVP140EDEP	849,07	FKVP140ESEP	1.350,39	FKVP140EDEFK	1.083,23	FKVP140ESEFK	1.584,54
160	FKVP160EDEP	1.064,72	FKVP160ESEP	1.402,23	FKVP160EDEFK	1.298,87	FKVP160ESEFK	1.636,36
200 (A2)	FKVP225EDEP	1.237,83	FKVP225ESEP	1.934,34	FKVP225EDEFK	1.471,98	FKVP225ESEFK	2.168,50
225	FKVP225EDEP	1.237,83	FKVP225ESEP	1.934,34	FKVP225EDEFK	1.471,98	FKVP225ESEFK	2.168,50
250*(A3)	FKVP280EDEP	3.166,80	FKVP280ESEP	4.659,88	FKVP280EDEFK	3.400,94	FKVP280ESEFK	4.894,02
280*	FKVP280EDEP	3.166,80	FKVP280ESEP	4.659,88	FKVP280EDEFK	3.400,94	FKVP280ESEFK	4.894,02
315*	FKVP315EDEP	3.367,61	FKVP315ESEP	4.860,70	FKVP315EDEFK	3.601,75	FKVP315ESEFK	5.094,86
355	FKVP355EDEP	Consultar	FKVP355ESEP	Consultar				
400	FKVP400EDEP	Consultar	FKVP400ESEP	Consultar				

50	FKVP050FDEP	696,68	FKVP050FSEP	842,24	FKVP050FDEFK	930,82	FKVP050FSEFK	1.076,39
63	FKVP063FDEP	720,93	FKVP063FSEP	866,51	FKVP063FDEFK	955,09	FKVP063FSEFK	1.100,66
75	FKVP075FDEP	769,49	FKVP075FSEP	915,06	FKVP075FDEFK	1.003,64	FKVP075FSEFK	1.149,22
90	FKVP090FDEP	890,43	FKVP090FSEP	949,77	FKVP090FDEFK	1.124,58	FKVP090FSEFK	1.183,91
110	FKVP110FDEP	933,16	FKVP110FSEP	1.166,69	FKVP110FDEFK	1.167,30	FKVP110FSEFK	1.400,84
125 (A1)	FKVP140FDEP	1.115,93	FKVP140FSEP	1.617,26	FKVP140FDEFK	1.350,08	FKVP140FSEFK	1.851,39
140	FKVP140FDEP	1.115,93	FKVP140FSEP	1.617,26	FKVP140FDEFK	1.350,08	FKVP140FSEFK	1.851,39
160	FKVP160FDEP	1.340,64	FKVP160FSEP	1.678,13	FKVP160FDEFK	1.574,78	FKVP160FSEFK	1.912,27
200 (A2)	FKVP225FDEP	1.597,97	FKVP225FSEP	2.294,52	FKVP225FDEFK	1.832,12	FKVP225FSEFK	2.528,66
225	FKVP225FDEP	1.597,97	FKVP225FSEP	2.294,52	FKVP225FDEFK	1.832,12	FKVP225FSEFK	2.528,66
250*(A3)	FKVP280FDEP	4.677,43	FKVP280FSEP	6.170,53	FKVP280FDEFK	4.911,56	FKVP280FSEFK	6.404,67
280*	FKVP280FDEP	4.677,43	FKVP280FSEP	6.170,53	FKVP280FDEFK	4.911,56	FKVP280FSEFK	6.404,67
315*	FKVP315FDEP	5.014,31	FKVP315FSEP	6.507,40	FKVP315FDEFK	5.248,44	FKVP315FSEFK	6.741,54
355	FKVP355FDEP	Consultar	FKVP355FSEP	Consultar				
400	FKVP400FDEP	Consultar	FKVP400FSEP	Consultar				

Válvula de mariposa industrial motorizada.
Cuerpo en PPGR y disco en PVC-U
Actuación neumática

(A1) = a utilizar con portabridas QPV especial no incluido (transforma la válvula de mariposa de 140 en 125)

(A2) = a utilizar con portabridas QPV especial no incluido (transforma la válvula de mariposa de 225 en 200)

(A3)= a utilizar con tubo de diámetro 250 SDR 26 (PN10) * Actuadores de aluminio

Las válvulas neumáticas se configuran NC (normalmente cerrada) de serie.

La configuración NA (normalmente abierta) se debe especificar en el pedido



INDUSTRIA

Válvulas motorizadas de PVC-U presión

Actuadores y accesorios



Para válvulas
de bola 2 vías VKD.



K

d	ACTUACIÓN ELÉCTRICA 24-240 V AC/DC				ACTUACIÓN NEUMÁTICA ALUMINIO DOBLE EFECTO				ACTUACIÓN NEUMÁTICA POLIAMIDA DOBLE EFECTO			
	Ref. 12 V AC/DC	€	Ref. 24-240V AC/DC	€	Ref.	€	Ref.	€	Ref.	€	Ref.	€
16	J4CB20	470,83	J4CS20	470,83	CHC052	151,47	CHC052SR	179,68	PPW	166,31	PPWS	187,79
20	J4CB20	470,83	J4CS20	470,83	CHC052	151,47	CHC052SR	179,68	PPW	166,31	PPWS	187,79
25	J4CB20	470,83	J4CS20	470,83	CHC052	151,47	CHC052SR	179,68	PPW	166,31	PPWS	187,79
32	J4CB20	470,83	J4CS20	470,83	CHC052	151,47	CHC052SR	179,68	PPW	166,31	PP00S	284,35
40	J4CB20	470,83	J4CS20	470,83	CHC052	151,47	CHC052SR	179,68	PPW	166,31	PP00S	284,35
50	J4CB20	470,83	J4CS20	470,83	CHC052	151,47	CHC063SR	232,08	PPW	166,31	PP10S	397,02
63	J4CB20	470,83	J4CS20	470,83	CHC052	151,47	CHC075SR	302,45	PP10	335,31	PP10S	397,02
75	J4CB55	711,75	J4CS55	711,75	CHC075	239,17	CHC083SR	345,99	PP10	335,31	PP20S	563,35
90	J4CB55	711,75	J4CS55	711,75	CHC075	239,17	CHC083SR	345,99	PP10	335,31	PP20S	563,35
110	J4CB85	1.045,67	J4CS85	1.045,67	CHC083	263,08	CHC105SR	641,34	PP10	335,31	PP20S	563,35

Para válvulas de bola 3 vías TKD.

16	J4CB20	470,83	J4CS20	470,83	CHC052	151,47	CHC052SR	179,68	PPW	166,31	PPWS	187,79
20	J4CB20	470,83	J4CS20	470,83	CHC052	151,47	CHC052SR	179,68	PPW	166,31	PPWS	187,79
25	J4CB20	470,83	J4CS20	470,83	CHC052	151,47	CHC052SR	179,68	PPW	166,31	PPWS	187,79
32	J4CB20	470,83	J4CS20	470,83	CHC052	151,47	CHC052SR	179,68	PPW	166,31	PP00S	284,35
40	J4CB20	470,83	J4CS20	470,83	CHC052	151,47	CHC063SR	232,08	PPW	166,31	PP10S	397,02
50	J4CB20	470,83	J4CS20	470,83	CHC063	183,35	CHC075SR	302,45	PP00	254,86	PP10S	397,02
63	J4CB20	470,83	J4CS20	470,83	CHC063	183,35	CHC075SR	302,45	PP10	335,31	PP10S	397,02

Para válvulas de mariposa FE.

50	J4CB20	470,83	J4CS20	470,83	CHC052	151,47	CHC063SR	232,08	PP00	254,86	PP10S	397,02
63	J4CB20	470,83	J4CS20	470,83	CHC052	151,47	CHC063SR	232,08	PP00	254,86	PP10S	397,02
75	J4CB55	711,75	J4CS55	711,75	CHC063	183,35	CHC075SR	302,45	PP00	254,86	PP10S	397,02
90	J4CB55	711,75	J4CS55	711,75	CHC075	239,17	CHC083SR	345,99	PP10	335,31	PP10S	397,02
110	J4CB55	711,75	J4CS55	711,75	CHC075	239,17	CHC105SR	641,34	PP10	335,31	PP20S	563,35
140	J4CB85	1.045,67	J4CS85	1.045,67	CHC083	263,08	CHC125SR	867,45	PP10	335,31	PA25S *	818,19
160	J4CB140	1.270,24	J4CS140	1.270,24	CHC083	263,08	CHC125SR	867,45	PP20	482,86	PA25S *	818,19
225	J4CB300	1.379,73	J4CS300	1.379,73	CHC105	494,29	CHC140SR	1.323,78	PP20	482,86	PA30S *	1.207,27
280	J4CB300	1.379,73	J4CS300	1.379,73	CHC125	653,69	CHC190SR	2.412,18	PA30 *	925,58	P40ST *	2.552,65
315	J4CB300	1.379,73	J4CS300	1.379,73	CHC140	892,87	CHC210SR	3.321,21	PA30 *	925,58	P40ST *	2.552,65

Para válvulas de mariposa FK.

50	J4CB20	470,83	J4CS20	470,83	CHC052	151,47	CHC063SR	232,08	PP00	254,86	PP10S	397,02
63	J4CB20	470,83	J4CS20	470,83	CHC052	151,47	CHC063SR	232,08	PP00	254,86	PP10S	397,02
75	J4CB55	711,75	J4CS55	711,75	CHC063	183,35	CHC075SR	302,45	PP00	254,86	PP10S	397,02
90	J4CB55	711,75	J4CS55	711,75	CHC075	239,17	CHC083SR	345,99	PP10	335,31	PP10S	397,02
110	J4CB55	711,75	J4CS55	711,75	CHC075	239,17	CHC105SR	641,34	PP10	335,31	PP20S	563,35
140	J4CB85	1.045,67	J4CS85	1.045,67	CHC083	263,08	CHC125SR	867,45	PP10	335,31	PA25S *	818,19
160	J4CB140	1.270,24	J4CS140	1.270,24	CHC083	263,08	CHC125SR	867,45	PP20	482,86	PA25S *	818,19
225	J4CB300	1.379,73	J4CS300	1.379,73	CHC105	494,29	CHC140SR	1.323,78	PP20	482,86	PA30S *	1.207,27
280	J4CB300	1.379,73	J4CS300	1.379,73	CHC125	653,69	CHC190SR	2.412,18	PA30 *	925,58	P40ST *	2.527,37
315	J4CB300	1.379,73	J4CS300	1.379,73	CHC140	892,87	CHC210SR	3.321,21	PA30 *	925,58	P40ST *	2.527,37
355	ITQ-0800-24	Consultar	ITQ-0800-220	Consultar	CHCN160	Consultar	CHCN210SR	Consultar				
400	ITQ-1100-24	Consultar	ITQ-1100-220	Consultar	CHCN160	Consultar	CHCN240SR	Consultar				

* 24V AC/DC ** 80-240V AC/DC

La válvula de mariposa de 140 es la misma que la de 125. Lo mismo sucede con la de 225-200 y la de 280- 250

* Actuadores de aluminio

Reductor manual para válvulas de mariposa FE y FK.

50 - 225 ILG/D-232/10 711,77

250 - 315 ILG/D-550 916,76



K

Ref.	Modelo	€
BSR2017	Para válvulas de bola ϕ 16 - 63 mm.	494,88
BSR2017	Para válvulas de bola ϕ 75 - 90 y mariposa ϕ 50 - 110 mm.	494,88
BSR2005	Para válvulas de bola ϕ 110 mm. y mariposa ϕ 140 - 315 mm.	579,11
BSR2017	Para válvulas de bola 3 vías ϕ 16 - 63 mm.	494,88

Bloque de seguridad.

Importe a añadir al precio del actuador.

Para válvulas con actuador **eléctrico J+J**.

K

Ref.	Modelo	€
DPS2017	Para válvulas de bola ϕ 16 - 63 mm.	426,44
DPS2017	Para válvulas de bola ϕ 75 - 90 y mariposa ϕ 50 - 110 mm.	426,44
DPS2005	Para válvulas de bola ϕ 110 mm. y mariposa ϕ 140 - 315 mm.	752,84
DPS2017	Para válvulas de bola 3 vías ϕ 16 - 63 mm.	426,44

Posicionador 4-20 mA.

Importe a añadir al precio del actuador.

Para válvulas con actuador **eléctrico J+J**.

K

Ref.	Modelo	Vías	Voltaje	€
EJ024CA-2008	Electroválvula J+J 2008	5/2	24 V CA	94,76
EJ024CC-2008	Electroválvula J+J 2008	5/2	24 V CC	94,76
EJ048CA-2008	Electroválvula J+J 2008	5/2	48 V CA	94,76
EJ110CA-2008	Electroválvula J+J 2008	5/2	110 V CA	94,76
EJ220CA-2008	Electroválvula J+J 2008	5/2	220V CA	94,76

Electroválvula.

3/2 vías consultar.

Para válvulas con actuador **neumático CH-AIR**.

K

Ref.	Modelo	€
CB2GC00TAPSS	2 finales de carrera ELECTROMECAÑICOS	84,24

Caja final de carrera electromecánico.

Los precios ya incluyen la instalación y montaje sobre el actuador

Para válvulas con actuador **neumático CH-AIR**.



Ref.	Modelo	€
CB2GP23TAPSS	2 finales de carrera INDUCTIVOS NBB2-V3-E2 3 hilos PNP	273,77
CB2GP41TAPSS	2 finales de carrera INDUCTIVOS NBB2-V3-E0 3 hilos NPN	273,77
CB2GP49TAPS	2 finales de carrera INDUCTIVOS NBB2-V3-Z4 2 hilos no	294,81

Caja final de carrera inductivo.

Los precios ya incluyen la instalación y montaje sobre el actuador

Para válvulas con actuador **neumático CH-AIR**.

YT-1200



YT-1000



YT-2300



Ref.	Modelo	€
YT-1200	Posicionador neumático 3-15 PSI	1.110,82
YT-1000	Posicionador electroneumático 4-20 mA	1.642,56
YT-2300	Posicionador electroneumático 4-20 mA + FEEDBACK 4-20 mA	3.006,09

Posicionador.

Los precios ya incluyen la instalación y montaje sobre el actuador

Para válvulas con actuador **neumático CH-AIR**.

Ref.	Modelo	Vías	Voltaje	€
EV-500.024A	Electroválvula PRISMA NAMUR	3/2 -5/2	24 V CA	115,32
EV-500.024C	Electroválvula PRISMA NAMUR	3/2 -5/2	24 V CC	115,32
EV-500.048A	Electroválvula PRISMA NAMUR	3/2 -5/2	48 V CA	115,32
EV-500.110A	Electroválvula PRISMA NAMUR	3/2 -5/2	110 V CA	115,32
EV-500.220A	Electroválvula PRISMA NAMUR	3/2 -5/2	220V CA	115,32

Electroválvula.

Para válvulas con actuador **neumático PRISMA**.

Ref.	Modelo	€
CFC-5601	2 finales de carrera ELECTROMECAÑICOS	100,75
CFC-5603	4 finales de carrera ELECTROMECAÑICOS	186,24

Caja final de carrera electromecánica **aluminio**.

Los precios ya incluyen la instalación y montaje sobre el actuador

Para válvulas con actuador **neumático PRISMA**.



K

Ref.	Modelo	€
CFC-5202	2 finales de carrera INDUCTIVOS NAMUR EEXI P+F	292,25
CFC-5204	2 finales de carrera INDUCTIVOS NPN P+F	580,89
CFC-5206	2 finales de carrera INDUCTIVOS PNP P+F	363,21

Caja final de carrera inductivo **aluminio**.
Para válvulas con actuador **neumático PRISMA**.

Los precios ya incluyen la instalación y montaje sobre el actuador



K

Ref.	Modelo	€
CFC-6301	2 finales de carrera ELECTROMECAÑICOS	132,43
CFC-6302	4 finales de carrera ELECTROMECAÑICOS rec. ORO	133,56

Caja final de carrera electromecánico **plástico**.
Para válvulas con actuador **neumático PRISMA**.

Los precios ya incluyen la instalación y montaje sobre el actuador



K

Ref.	Modelo	€
CFC-6321	1 final de carrera INDUCTIVO P+F NBB2-V3-E2 (PNP)	239,74
CFC-6322	2 finales de carrera INDUCTIVOS P+F NBB2-V3-E2 (PNP)	323,77

Caja final de carrera inductivo **plástico**.
Para válvulas con actuador **neumático PRISMA**.

Los precios ya incluyen la instalación y montaje sobre el actuador

PST-001



PST-002



PST-003



K

Ref.	Modelo	€
PST-001	Posicionador electroneumático 4-20 mA	1.391,12
PST-002	Posicionador electroneumático 4-20 mA + 2 finales de carrera SPDT	1.749,28
PST-003	Posicionador electroneumático 4-20 mA + 2 finales de carrera SPDT + FEEDBACK 4-20 mA	2.616,62

Posicionador.

Para válvulas con actuador **neumático PRISMA**.

Los precios ya incluyen la instalación y montaje sobre el actuador



Válvulas motorizadas de PVC-U presión

Válvulas de membrana actuadas



DK/CP NC



VM/CP NC

d	Modelo	DN	Ref. EPDM	€ EPDM	Ref. FKM	€ FKM	Ref. PTFE	L € PTFE
20	DKDV/CP NC	15	DKDVNC020E	209,27	DKDVNC020F	245,08	DKDVNC020P	259,93
25	DKDV/CP NC	20	DKDVNC025E	219,72	DKDVNC025F	256,99	DKDVNC025P	272,60
32	DKDV/CP NC	25	DKDVNC032E	269,04	DKDVNC032F	313,72	DKDVNC032P	331,25
40	DKDV/CP NC	32	DKDVNC040E	358,42	DKDVNC040F	432,01	DKDVNC040P	451,32
50	DKDV/CP NC	40	DKDVNC050E	406,70	DKDVNC050F	486,30	DKDVNC050P	508,11
63	DKDV/CP NC	50	DKDVNC063E	569,73	DKDVNC063F	705,27	DKDVNC063P	701,50
75	DKDV/CP NC	65	DKDVNC075E	683,66	DKDVNC075F	846,33	DKDVNC075P	841,81
90	VMDV/CP NC	80	VMDVNC090E	1.045,36	VMDVNC090F	1.393,30	VMDVNC090P	1.208,39
110	VMDV/CP NC	100	VMDVNC110E	1.292,38	VMDVNC110F	1.624,17	VMDVNC110P	1.446,48

Válvula neumática **NORMALMENTE CERRADA.**

M-M encolar.



DK/CP NO



VM/CP NO

d	Modelo	DN	Ref. EPDM	€ EPDM	Ref. FKM	€ FKM	Ref. PTFE	L € PTFE
20	DKDV/CP NO	15	DKDVNO020E	171,70	DKDVNO020F	207,49	DKDVNO020P	222,38
25	DKDV/CP NO	20	DKDVNO025E	182,14	DKDVNO025F	219,40	DKDVNO025P	235,02
32	DKDV/CP NO	25	DKDVNO032E	226,89	DKDVNO032F	292,99	DKDVNO032P	313,20
40	DKDV/CP NO	32	DKDVNO040E	236,20	DKDVNO040F	331,12	DKDVNO040P	355,96
50	DKDV/CP NO	40	DKDVNO050E	277,51	DKDVNO050F	378,98	DKDVNO050P	407,08
63	DKDV/CP NO	50	DKDVNO063E	358,19	DKDVNO063F	529,33	DKDVNO063P	524,44
75	DKDV/CP NO	65	DKDVNO075E	429,83	DKDVNO075F	635,20	DKDVNO075P	629,31
90	VMDV/CP NO	80	VMDVNO090E	697,51	VMDVNO090F	1.108,43	VMDVNO090P	889,63
110	VMDV/CP NO	100	VMDVNO110E	1.061,80	VMDVNO110F	1.504,71	VMDVNO110P	1.249,99

Válvula neumática **NORMALMENTE ABIERTA.**

M-M encolar.



DK/CP DE



VM/CP DE

d	Modelo	DN	Ref. EPDM	€ EPDM	Ref. FKM	€ FKM	Ref. PTFE	L € PTFE
20	DKDV/CP DE	15	DKDVDA020E	134,14	DKDVDA020F	169,93	DKDVDA020P	184,81
25	DKDV/CP DE	20	DKDVDA025E	144,58	DKDVDA025F	181,85	DKDVDA025P	197,47
32	DKDV/CP DE	25	DKDVDA032E	197,36	DKDVDA032F	259,15	DKDVDA032P	278,25
40	DKDV/CP DE	32	DKDVDA040E	214,71	DKDVDA040F	301,01	DKDVDA040P	323,60
50	DKDV/CP DE	40	DKDVDA050E	183,60	DKDVDA050F	250,74	DKDVDA050P	269,35
63	DKDV/CP DE	50	DKDVDA063E	236,99	DKDVDA063F	350,22	DKDVDA063P	346,98
75	DKDV/CP DE	65	DKDVDA075E	284,38	DKDVDA075F	420,27	DKDVDA075P	416,37
90	VMDV/CP DE	80	VMDVDA090E	870,49	VMDVDA090F	1.281,42	VMDVDA090P	1.062,60
110	VMDV/CP DE	100	VMDVDA110E	1.227,85	VMDVDA110F	1.549,70	VMDVDA110P	1.416,02

Válvula neumática **DOBLE EFECTO**

M-M encolar.

DK/CP NC

d	Modelo	DN	Ref. EPDM	€ EPDM	Ref. FKM	€ FKM	Ref. PTFE	L € PTFE
20	DKUIV/CP NC	15	DKUIVNC020E	210,07	DKUIVNC020F	255,46	DKUIVNC020P	274,11
25	DKUIV/CP NC	20	DKUIVNC025E	221,96	DKUIVNC025F	263,68	DKUIVNC025P	289,03
32	DKUIV/CP NC	25	DKUIVNC032E	274,29	DKUIVNC032F	333,01	DKUIVNC032P	354,90
40	DKUIV/CP NC	32	DKUIVNC040E	364,55	DKUIVNC040F	457,42	DKUIVNC040P	480,22
50	DKUIV/CP NC	40	DKUIVNC050E	421,85	DKUIVNC050F	526,12	DKUIVNC050P	552,65
63	DKUIV/CP NC	50	DKUIVNC063E	585,88	DKUIVNC063F	751,74	DKUIVNC063P	747,24

 Válvula neumática **NORMALMENTE CERRADA.**

Con enlaces H-H para encolar.

DK/CP NO

d	Modelo	DN	Ref. EPDM	€ EPDM	Ref. FKM	€ FKM	Ref. PTFE	L € PTFE
20	DKUIV/CP NO	15	DKUIVNO020E	172,50	DKUIVNO020F	217,89	DKUIVNO020P	236,54
25	DKUIV/CP NO	20	DKUIVNO025E	184,40	DKUIVNO025F	226,11	DKUIVNO025P	251,46
32	DKUIV/CP NO	25	DKUIVNO032E	241,55	DKUIVNO032F	313,83	DKUIVNO032P	285,89
40	DKUIV/CP NO	32	DKUIVNO040E	263,29	DKUIVNO040F	366,13	DKUIVNO040P	395,52
50	DKUIV/CP NO	40	DKUIVNO050E	319,09	DKUIVNO050F	436,45	DKUIVNO050P	469,45
63	DKUIV/CP NO	50	DKUIVNO063E	411,85	DKUIVNO063F	600,24	DKUIVNO063P	594,13

 Válvula neumática **NORMALMENTE ABIERTA.**

Con enlaces H-H para encolar.

DK/CP DE

d	Modelo	DN	Ref. EPDM	€ EPDM	Ref. FKM	€ FKM	Ref. PTFE	L € PTFE
20	DKUIV/CP DE	15	DKUIVDA020E	134,94	DKUIVDA020F	180,32	DKUIVDA020P	198,98
25	DKUIV/CP DE	20	DKUIVDA025E	146,83	DKUIVDA025F	188,55	DKUIVDA025P	213,87
32	DKUIV/CP DE	25	DKUIVDA032E	210,82	DKUIVDA032F	278,39	DKUIVDA032P	304,43
40	DKUIV/CP DE	32	DKUIVDA040E	239,36	DKUIVDA040F	332,83	DKUIVDA040P	359,55
50	DKUIV/CP DE	40	DKUIVDA050E	290,08	DKUIVDA050F	396,77	DKUIVDA050P	524,27
63	DKUIV/CP DE	50	DKUIVDA063E	374,40	DKUIVDA063F	545,68	DKUIVDA063P	540,11

 Válvula neumática **DOBLE EFECTO.**

Con enlaces H-H para encolar.

**DK/CP NC**

Rh	Modelo	DN	Ref. EPDM	€ EPDM	Ref. FKM	€ FKM	Ref. PTFE	L € PTFE
1/2"	DKUFV/CP NC	15	DKUFVNC012E	210,07	DKUFVNC012F	255,46	DKUFVNC012P	274,11
3/4"	DKUFV/CP NC	20	DKUFVNC034E	221,96	DKUFVNC034F	263,68	DKUFVNC034P	289,03
1"	DKUFV/CP NC	25	DKUFVNC100E	274,29	DKUFVNC100F	333,01	DKUFVNC100P	354,90
1 1/4"	DKUFV/CP NC	32	DKUFVNC114E	364,55	DKUFVNC114F	457,42	DKUFVNC114P	480,22
1 1/2"	DKUFV/CP NC	40	DKUFVNC112E	421,85	DKUFVNC112F	526,12	DKUFVNC112P	552,65
2"	DKUFV/CP NC	50	DKUFVNC200E	573,85	DKUFVNC200F	751,74	DKUFVNC200P	747,24

 Válvula neumática **NORMALMENTE CERRADA.**

Con enlaces H-H para roscar.

**DK/CP NO**

Rh	Modelo	DN	Ref. EPDM	€ EPDM	Ref. FKM	€ FKM	Ref. PTFE	L € PTFE
1/2"	DKUFV/CP NO	15	DKUFVNO012E	172,50	DKUFVNO012F	217,89	DKUFVNO012P	236,54
3/4"	DKUFV/CP NO	20	DKUFVNO034E	184,40	DKUFVNO034F	226,11	DKUFVNO034P	251,46
1"	DKUFV/CP NO	25	DKUFVNO100E	241,55	DKUFVNO100F	313,83	DKUFVNO100P	285,89
1 1/4"	DKUFV/CP NO	32	DKUFVNO114E	263,29	DKUFVNO114F	366,13	DKUFVNO114P	395,52
1 1/2"	DKUFV/CP NO	40	DKUFVNO112E	319,09	DKUFVNO112F	436,45	DKUFVNO112P	469,45
2"	DKUFV/CP NO	50	DKUFVNO200E	411,85	DKUFVNO200F	600,24	DKUFVNO200P	594,13

 Válvula neumática **NORMALMENTE ABIERTA.**

Con enlaces H-H para roscar.

**DK/CP DE**

Rh	Modelo	DN	Ref. EPDM	€ EPDM	Ref. FKM	€ FKM	Ref. PTFE	€ PTFE
1/2"	DKUFV/CP DE	15	DKUFVDA012E	134,94	DKUFVDA012F	180,32	DKUFVDA012P	198,98
3/4"	DKUFV/CP DE	20	DKUFVDA034E	146,83	DKUFVDA034F	188,55	DKUFVDA034P	213,87
1"	DKUFV/CP DE	25	DKUFVDA100E	210,82	DKUFVDA100F	278,39	DKUFVDA100P	304,43
1 1/4"	DKUFV/CP DE	32	DKUFVDA114E	239,36	DKUFVDA114F	332,83	DKUFVDA114P	359,55
1 1/2"	DKUFV/CP DE	40	DKUFVDA112E	290,08	DKUFVDA112F	396,77	DKUFVDA112P	426,77
2"	DKUFV/CP DE	50	DKUFVDA200E	374,40	DKUFVDA200F	545,68	DKUFVDA200P	540,11

 Válvula neumática **DOBLE EFECTO.**

Con enlaces H-H para roscar.



DK/CP NC



VM/CP NC

d	Modelo	DN	Ref. EPDM	€ EPDM	Ref. FKM	€ FKM	Ref. PTFE	L € PTFE
20	DKOV/CP NC	15	DKOVNC020E	240,68	DKOVNC020F	276,44	DKOVNC020P	291,34
25	DKOV/CP NC	20	DKOVNC025E	252,68	DKOVNC025F	289,93	DKOVNC025P	305,56
32	DKOV/CP NC	25	DKOVNC032E	309,41	DKOVNC032F	354,08	DKOVNC032P	371,58
40	DKOV/CP NC	32	DKOVNC040E	412,19	DKOVNC040F	485,75	DKOVNC040P	505,07
50	DKOV/CP NC	40	DKOVNC050E	467,72	DKOVNC050F	547,34	DKOVNC050P	569,13
63	DKOV/CP NC	50	DKOVNC063E	655,19	DKOVNC063F	790,75	DKOVNC063P	786,97
75	DKOV/CP NC	65	DKOVNC075E	786,24	DKOVNC075F	948,91	DKOVNC075P	944,36
90	VMOV/CP NC	80	VMOVNC090E	1.202,20	VMOVNC090F	1.550,08	VMOVNC090P	1.365,20
110	VMOV/CP NC	100	VMOVNC110E	1.486,26	VMOVNC110F	1.817,45	VMOVNC110P	1.640,19

Válvula neumática **NORMALMENTE CERRADA.**

Con bridas DIN.

Disponibles con bridas ANSI 150 libras al mismo precio



DK/CP NO



VM/CP NO

d	Modelo	DN	Ref. EPDM	€ EPDM	Ref. FKM	€ FKM	Ref. PTFE	L € PTFE
20	DKOV/CP NO	15	DKOVNO020E	203,09	DKOVNO020F	238,86	DKOVNO020P	253,77
25	DKOV/CP NO	20	DKOVNO025E	215,11	DKOVNO025F	252,36	DKOVNO025P	268,00
32	DKOV/CP NO	25	DKOVNO032E	272,93	DKOVNO032F	339,00	DKOVNO032P	295,25
40	DKOV/CP NO	32	DKOVNO040E	295,33	DKOVNO040F	390,23	DKOVNO040P	415,07
50	DKOV/CP NO	40	DKOVNO050E	344,63	DKOVNO050F	446,12	DKOVNO050P	474,20
63	DKOV/CP NO	50	DKOVNO063E	452,21	DKOVNO063F	623,35	DKOVNO063P	618,45
75	DKOV/CP NO	65	DKOVNO075E	542,65	DKOVNO075F	748,02	DKOVNO075P	742,14
90	VMOV/CP NO	80	VMOVNO090E	854,32	VMOVNO090F	1.265,25	VMOVNO090P	1.046,42
110	VMOV/CP NO	100	VMOVNO110E	1.208,58	VMOVNO110F	1.642,35	VMOVNO110P	1.396,81

Válvula neumática **NORMALMENTE ABIERTA.**

Con bridas DIN.

Disponibles con bridas ANSI 150 libras al mismo precio



DK/CP DE



VM/CP DE

d	Modelo	DN	Ref. EPDM	€ EPDM	Ref. FKM	€ FKM	Ref. PTFE	L € PTFE
20	DKOV/CP DE	15	DKOVDA020E	165,53	DKOVDA020F	201,30	DKOVDA020P	216,21
25	DKOV/CP DE	20	DKOVDA025E	177,54	DKOVDA025F	214,79	DKOVDA025P	230,42
32	DKOV/CP DE	25	DKOVDA032E	240,73	DKOVDA032F	302,50	DKOVDA032P	321,60
40	DKOV/CP DE	32	DKOVDA040E	268,48	DKOVDA040F	354,76	DKOVDA040P	377,34
50	DKOV/CP DE	40	DKOVDA050E	313,30	DKOVDA050F	405,56	DKOVDA050P	431,09
63	DKOV/CP DE	50	DKOVDA063E	411,10	DKOVDA063F	566,68	DKOVDA063P	562,23
75	DKOV/CP DE	65	DKOVDA075E	493,31	DKOVDA075F	680,02	DKOVDA075P	674,68
90	VMOV/CP DE	80	VMOVDA090E	1.027,31	VMOVDA090F	1.438,24	VMOVDA090P	1.219,38
110	VMOV/CP DE	100	VMOVDA110E	1.374,63	VMOVDA110F	1.678,14	VMOVDA110P	1.562,82

Válvula neumática **DOBLE EFECTO.**

Con bridas DIN.

Disponibles con bridas ANSI 150 libras al mismo precio

CMDV/CP NC *M-M encolar.*
CMIV/CP NC *H-H encolar.*
CMUIV/CP NC *H-H enlaces encolar.*
CMFV/CP NC *H-H roscar.*

L

d-Rh	Ref. EPDM	DN	€ EPDM	€ FKM	€ PTFE
20	CMDVNC020E	15	100,75	114,80	127,06
16	CMIVNC016E	12	94,64	112,17	120,04
20	CMIVNC020E	15	94,64	112,17	120,04
20-½"	CMUIVNC020E	15	129,71	142,85 (A)	154,23
¾"	CMFVNC038E	12	94,64	112,17	120,04
½"	CMFVNC012E	15	94,64	112,17	120,04

 Válvula de membrana compacta neumática
NORMALMENTE CERRADA.

 Código en FKM termina en "F" en lugar de "E"
 Código en PTFE termina en "P" en lugar de "E"
 (A) = Juntas en FKM

CMDV/CP NO *M-M encolar.*
CMIV/CP NO *H-H encolar.*
CMUIV/CP NO *H-H enlaces encolar.*
CMFV/CP NO *H-H roscar.*

L

d-Rh	Ref. EPDM	DN	€ EPDM	€ FKM	€ PTFE
20	CMDVNO020E	15	99,01	113,04	124,44
16	CMIVNO016E	12	93,78	108,65	118,29
20	CMIVNO020E	15	93,78	108,65	118,29
20-½"	CMUIVNO020E	15	128,83	140,20 (A)	152,47
¾"	CMFVNO038E	12	93,78	108,65	118,29
½"	CMFVNO012E	15	93,78	108,65	118,29

 Válvula de membrana compacta neumática
NORMALMENTE ABIERTA.

 Código en FKM termina en "F" en lugar de "E"
 Código en PTFE termina en "P" en lugar de "E"
 (A) = Juntas en FKM

CMDV/CP DE *M-M encolar.*
CMIV/CP DE *H-H encolar.*
CMUIV/CP DE *H-H enlaces encolar.*
CMFV/CP DE *H-H roscar.*

L

d-Rh	Ref. EPDM	DN	€ EPDM	€ FKM	€ PTFE
20	CMDVDA020E	15	99,01	113,04	124,44
16	CMIVDA016E	12	93,78	108,65	118,29
20	CMIVDA020E	15	93,78	108,65	118,29
20-½"	CMUIVDA020E	15	128,83	140,20 (A)	152,47
¾"	CMFVDA038E	12	93,78	108,65	118,29
½"	CMFVDA012E	15	93,78	108,65	118,29

 Válvula de membrana compacta neumática
DOBLE EFECTO.

 Código en FKM termina en "F" en lugar de "E"
 Código en PTFE termina en "P" en lugar de "E"
 (A) = Juntas en FKM

DKDDV/CP NO

L

d	Ref. EPDM	DN	PN	€ EPDM
20	DKDDVNO020E	15	8	57,80
25	DKDDVNO025E	20	8	67,48
32	DKDDVNO032E	25	8	74,49
40	DKDDVNO040E	32	8	85,87
50	DKDDVNO050E	40	8	105,13
63	DKDDVNO063E	50	8	113,04
75	DKDDVNO075E	65	8	135,64

Válvula de membrana normalmente abierta acción directa.

 Disponible embridad
 Precios: Consultar

Membrana en EPDM. M-M encolar.

DKDUIV/CP NO

L

d	Ref. EPDM	DN	PN	€ EPDM
20	DKDUIVNO020E	15	8	68,34
25	DKDUIVNO025E	20	8	78,85
32	DKDUIVNO032E	25	8	89,39
40	DKDUIVNO040E	32	8	106,93
50	DKDUIVNO050E	40	8	142,92
63	DKDUIVNO063E	50	8	147,19

Válvula de membrana normalmente abierta acción directa.

Membrana en EPDM. H-H enlaces encolar.

DKDUFV/CP NO

L

Rh	Ref. EPDM	DN	PN	€ EPDM
½"	DKDUFVNO012E	15	8	74,49
¾"	DKDUFVNO034E	20	8	85,01
1"	DKDUFVNO100E	25	8	97,26
1¼"	DKDUFVNO114E	32	8	125,30
1½"	DKDUFVNO112E	40	8	154,22
2"	DKDUFVNO200E	50	8	169,12

Válvula de membrana normalmente abierta acción directa.

Membrana en EPDM. H-H enlaces roscar.

DKBDV/CP NC

d	Ref. EPDM	DN	PN	L € EPDM
20	DKBDVNC020E	15	6	194,70
25	DKBDVNC025E	20	6	204,43
32	DKBDVNC032E	25	6	254,30
40	DKBDVNC040E	32	6	319,97
50	DKBDVNC050E	40	6	335,64
63	DKBDVNC063E	50	6	470,16
75	DKBDVNC075E	65	6	564,19

Válvula de membrana neumática
Normalmente Cerrada.

M-M encolar

Actuador a pistón

DKBUIV/CP NC

d	Ref. EPDM	DN	PN	L € EPDM
20	DKBUIVNC020E	15	6	195,44
25	DKBUIVNC025E	20	6	206,50
32	DKBUIVNC032E	25	6	259,27
40	DKBUIVNC040E	32	6	325,47
50	DKBUIVNC050E	40	6	348,11
63	DKBUIVNC063E	50	6	483,46

Válvula de membrana neumática
Normalmente Cerrada.

Con enlaces H-H encolar

Actuador a pistón

DKBUFV/CP NC

Rh	Ref. EPDM	DN	PN	L € EPDM
½"	DKBUFVNC012E	15	6	195,44
¾"	DKBUFVNC034E	20	6	206,50
1"	DKBUFVNC100E	25	6	259,26
1 ¼"	DKBUFVNC114E	32	6	325,47
1 ½"	DKBUFVNC112E	40	6	348,11
2"	DKBUFVNC200E	50	6	483,46

Válvula de membrana neumática
Normalmente Cerrada.

Con enlaces H-H para roscar

Actuador a pistón

DKBOV/CP NC

d	Ref. EPDM	DN	PN	L € EPDM
20	DKBOVNC020E	15	6	223,92
25	DKBOVNC025E	20	6	235,07
32	DKBOVNC032E	25	6	297,95
40	DKBOVNC040E	32	6	378,12
50	DKBOVNC050E	40	6	396,63
63	DKBOVNC063E	50	6	555,65
75	DKBOVNC075E	65	6	722,34

Válvula de membrana neumática
Normalmente Cerrada.

Con bridas DIN

Actuador a pistón

DKBOAV/CP NC

d	Ref. EPDM	DN	PN	L € EPDM
½"	DKBOAVNC012E	15	6	223,92
¾"	DKBOAVNC034E	20	6	235,07
1"	DKBOAVNC100E	25	6	297,95
1 ¼"	DKBOAVNC114E	32	6	378,12
1 ½"	DKBOAVNC112E	40	6	396,63
2"	DKBOAVNC200E	50	6	555,65
2 ½"	DKBOAVNC212E	65	6	722,34

Válvula de membrana neumática
Normalmente Cerrada.

Con bridas ANSI 150 lbs.

Actuador a pistón



INDUSTRIA

Válvulas motorizadas de PVC-U presión

Accesorios válvulas de membrana



M

DN	Ref.	Tipo de válvula	€
80÷100	ZIN005	VM/CP NC-NO-DE	10,44

Indicador óptico de posición.
Con junta y tapón protector.



M

DN	Ref.	Tipo de válvula	€
15÷32	ZLI001	DK/CP NC	55,19
15÷32	ZLI002	DK/CP NO-DE	49,19
40÷65	ZLI003	DK/CP NC	62,56
40÷65	ZLI004	DK/CP NO-DE	49,19
12÷15	ZLI010	CM/CP NC-NO-DE	68,60
80÷100		VM/CP NC-NO *	

Limitador de carrera con indicador
óptico de posición. Con junta y tapón protector. * Montaje en fábrica



M

DN	Ref.	Tipo de válvula	€
40	ZLP001	DKM/CP NC	35,82
50÷65	ZLP002	DKM/CP NC	54,95
40÷65	ZLP003	DKM/CP NO-DE	35,82
80÷100		VM/CP NO-DE *	
12÷15	ZLP005	CM/CP NC-NO-DE	61,04
80÷100		VM/CP NC *	

Limitador de carrera. * Montaje en fábrica
Con junta y tapón protector.



M

DN	Ref.	Tipo de válvula	€
15÷32	ZLIM001	DK/CP NC	59,65
15÷32	ZLIM002	DK/CP NO-DE	67,96
40÷65	ZLIM003	DK/CP NC	59,64
40÷65	ZLIM004	DK/CP NO-DE	59,65

Limitador de carrera con indicador
óptico de posición. Con junta y tapón protector. Apertura manual
(Montaje en fábrica)



M

DN	Ref.	Tipo de válvula	€
15÷65	ZSMMEC001	DK/CP NC-NO-DE	241,41
80÷100	ZSMMEC004	VM/CP NC	241,41
80	ZSMMEC005	VM/CP NO-DE	259,33
100	ZSMMEC006	VM/CP NO-DE	267,54

Caja micro contactos.

IP65. 2 Conectores electromecánicos.



M

DN	Ref.	Tipo de válvula	€
15÷65	ZMSNAM001	DK/CP NC-NO-DE	393,52
80÷100	ZMSNAM004	VM/CP NC	412,93
80	ZMSNAM005	VM/CP NO-DE	412,93
100	ZMSNAM006	VM/CP NO-DE	806,74

Caja micro contactos.

IP65. Seguridad: Eex ia IIC T6.

2 Conectores inductivos NAMUR.



M

DN	Ref.	Tipo de válvula	€
15÷65	ZMSPNP001	DK/CP NC-NO-DE	668,80
80÷100	ZMSPNP004	VM/CP NC	691,88
80	ZMSPNP005	VM/CP NO-DE	691,88
100	ZMSPNP006	VM/CP NO-DE	806,74

Caja micro contactos.

IP65. 2 Sensores (3 hilos) NAMUR.



M

DN	Ref.	Tipo de válvula	€
12÷15	ZMSMECCM	CM/CP NC-NO-DE	208,66

Caja micro contactos.

IP65. 2 Conectores electromecánicos.

DN	Ref.	Tipo de válvula	€
12÷15	ZMSNAMCM	CM/CP NC-NO-DE	476,95

Caja micro contactos.

IP65. Seguridad: Eex ia IIC T6.

2 Conectores inductivos NAMUR.



M

DN	Ref.	Tipo de válvula	€
15÷32	ZMSMECLIM001	DK/CP NC	310,54
40	ZMSMECLIM002	DK/CP NC	310,54
50÷65	ZMSMECLIM003	DK/CP NC	310,54
80	ZMSMECLIM005	VM/CP NC	310,54
100	ZMSMECLIM006	VM/CP NC	310,54

Caja micro contactos.

IP65. 2 Conectores electromecánicos.

Con limitador de carrera.



M

DN	Ref.	Tipo de válvula	€
15÷32	ZMSNAMLIM001	DK/CP NC	442,08
40	ZMSNAMLIM002	DK/CP NC	442,08
50÷65	ZMSNAMLIM003	DK/CP NC	442,08
80	ZMSNAMLIM005	VM/CP NC	512,75
100	ZMSNAMLIM006	VM/CP NC	442,08

Caja micro contactos.

IP65. Seguridad: Eex ia IIC T6. 2 Conectores inductivos NAMUR.

Con limitador de carrera.



M

DN	Ref.	Tipo de válvula	€
15÷32	ZMSPNPLIM001	DK/CP NC	745,61
40	ZMSPNPLIM002	DK/CP NC	745,61
50÷65	ZMSPNPLIM003	DK/CP NC	745,61
80	ZMSPNPLIM005	VM/CP NC	858,43
100	ZMSPNPLIM006	VM/CP NC	745,61

Caja micro contactos.

IP65. 2 Sensores inductivos PNP 3 hilos.

Con limitador de carrera.



M

DN	Ref.	Tipo de válvula	€
15÷32	ZMSFC001	DK/CP NC	38,76
40÷65	ZMSFC002	DK/CP NC	38,76
80÷100	ZMSFC005	VM/CP NC	38,76
12÷15	ZMSFC009	CM/CP NC-NO-DE	38,76

Caja micro contactos (24.90).

IP65. 1 Conector electromecánico.



M

DN	Ref.	Tipo de válvula	€
15÷65		DK/CP NC-NO*	1.416,32
80÷100		VM/CP NC-NO*	1.416,32

Posicionador electro neumático.

SIMPLE EFECTO.

Señal input 4-20 mA. Para válvulas NC-NO.

* Montaje en fábrica



M

DN	Ref.	Tipo de válvula	€
15÷65		DK/CP DE*	1.746,92
80÷100		VM/CP DE*	1.746,92

Posicionador electro neumático.

DOBLE EFECTO.

Señal input 4-20 mA. Para válvulas DE.

* Montaje en fábrica



M

DN	Ref.	Tipo de válvula	€
15÷65	ZMS001	DK/CP NC-NO-DE	339,51
80÷100	ZMS001	VM/CP NC	339,51
12÷15	ZMS002	CM/CP NC-NO-DE	339,51

Caja micro contactos libres.

IP67. 2 Sensores libres.

Ref.	Cable conexión	€
3CNZMS	5 metros	26,08

Conector "5 conectores" PIN M12 x 1

Para contactos libres ZMS001/2

M



M

Ref.	Tipo de válvula	€
SPNC14N024DC	DK-DKB-DKD-VM-CM/CP Voltaje 24V DC	114,27
SPNC14N024AC	DK-DKB-DKD-VM-CM/CP Voltaje 24V AC 50 Hz	114,27
SPNC14N110AC	DK-DKB-DKD-VM-CM/CP Voltaje 110V AC 50 Hz	114,27
SPNC14N220AC	DK-DKB-DKD-VM-CM/CP Voltaje 220V AC 50 Hz	114,27

Válvula piloto SP/NC normalmente cerrada.

Juntas NBR. 3/2 vías.

Rosca H 1/4". Montaje directo.



M

Ref.	Tipo de válvula	€
SBNC18N024DC	DK-DKB-DKD-VM-CM/CP Voltaje 24V DC	103,62
SBNC18N024AC	DK-DKB-DKD-VM-CM/CP Voltaje 24V AC 50 Hz	103,62
SBNC18N110AC	DK-DKB-DKD-VM-CM/CP Voltaje 110V AC 50 Hz	103,62
SBNC18N220AC	DK-DKB-DKD-VM-CM/CP Voltaje 220V AC 50 Hz	103,62

Válvula piloto SB/NC normalmente cerrada.

Juntas NBR. 3/2 vías.

Rosca H 1/8". Montaje en batería.



M

Ref.	Tipo de válvula	€
SDNO14N024DC	DK-DKB-DKD-CM/CP Voltaje 24V DC	152,53

Válvula piloto SD/NO normalmente abierta.

Juntas NBR. 3/2 vías.

Rosca H 1/4". Montaje directo.



M

Ref.	Tipo de válvula	€
SMNO18N024DC	DK-DKB-DKD-CM/CP Voltaje 24V DC	153,65

Válvula piloto SM/NO normalmente abierta.

Juntas NBR. 3/2 vías.

Rosca H 1/8". Montaje en batería.



M

Ref.	Tipo de válvula	€
2EV024DC	DK-DKB/CP* Voltaje 24V	104,63
2EV024AC	DCK-DKB/CP* Voltaje 24V AC 50 Hz	104,63
2EV110AC	DK-DKB/CP* Voltaje 110V AC 50 Hz	104,63
2EV220AC	DK-DKB/CP* Voltaje 220V AC 50 Hz	104,63

Válvula piloto NAMUR "2EV".
NAMUR 3-5/2 vías. Montaje directo.

* Para montar con adaptador
ZAD2428001



M

DN	Ref.	Tipo de válvula	€
15÷65	ZAD2428001	DK/CP	31,31
15÷65	ZAD2428001	DKBCP	31,31

Adaptador NAMUR para válvula piloto "2EV".

Conexión NAMUR.



SVUIV

d - Rh	Ref.	DN	PN	L	
				€ EPDM	€ FKM
20 - 1/2"	SVUIV020E	15	16	115,77	118,84
25 - 3/4"	SVUIV025E	20	16	124,05	128,19
32 - 1"	SVUIV032E	25	16	133,32	137,47

Válvula de sobrepresión seguridad

Con enlaces H-H

para encolar (roscar bajo pedido).

Código en FKM termina en "F" en lugar de "E"

Rango de calibración: 0,3 - 4 bars



VSF

d	Ref. EPDM	DN	PN	L	
				€ EPDM	€ PTFE
16	VSF016E	10	10	230,02	263,92
20	VSF020E	15	10	267,81	284,12
25	VSF025E	20	10	299,47	324,94
32	VSF032E	25	10	316,66	340,96
40	VSF040E	32	10	397,63	435,68
50	VSF050E	40	10	760,73	791,50
63	VSF063E	50	10	893,85	922,28
75	VSF075E	65	10	1.200,41	1.258,19
90	VSF090E	80	10	2.011,49	2.106,18
110	VSF110E	100	10	2.891,55	3.007,36

Válvula de sobrepresión-alivio.

M-M encolar.

Código en PTFE termina en "P" en lugar de "E"

Rango de calibración: 0,5 - 10 bars



LR

d	DN	Ref. EPDM	€ EPDM	Ref. FKM	€ FKM	Ref. PTFE	L
							€ PTFE
16	10	HOLRE305	Consultar	HOLRF305	Consultar	HOLRG305	Consultar
20	15	HOLRE306	Consultar	HOLRF306	Consultar	HOLRG306	Consultar
25	20	HOLRE307	Consultar	HOLRF307	Consultar	HOLRG307	Consultar
32	25	HOLRE308	Consultar	HOLRF308	Consultar	HOLRG308	Consultar
40	32	HOLRE309	Consultar	HOLRF309	Consultar	HOLRG309	Consultar
50	40	HOLRE310	Consultar	HOLRF310	Consultar	HOLRG310	Consultar
63	50	HOLRE311	Consultar	HOLRF311	Consultar	HOLRG311	Consultar

Válvula para carga y alivio de presión. **Dos funciones en la misma válvula.**

H-H con enlaces encolar.

Rango de calibración presión: 0 - 3 bars
Rango de calibración alivio: 0 - 10 bars



VPR

d	Ref. EPDM	DN	PN	L	
				€ EPDM	€ FKM
16	VPRDV016E	10	10	587,97	608,83
20	VPRDV020E	15	10	587,97	608,83
25	VPRDV025E	20	10	748,45	781,69
32	VPRDV032E	25	10	748,45	781,69
40	VPRDV040E	32	10	900,91	941,08
50	VPRDV050E	40	10	900,91	941,08
63	VPRDV063E	50	10	1.274,97	1.314,60

Válvula reductora de presión.

M-M encolar.

Código en FKM termina en "F" en lugar de "E"

Rango de calibración: 0,5 - 9 bars



VCP

d	Ref. EPDM	DN	PN	L	
				€ EPDM	€ PTFE
16	VCPDV016E	10	10	208,90	223,57
20	VCPDV020E	15	10	211,20	232,73
25	VCPDV025E	20	10	281,58	305,89
32	VCPDV032E	25	10	300,61	332,93
40	VCPDV040E	32	10	384,08	412,54
50	VCPDV050E	40	10	726,48	753,15
63	VCPDV063E	50	10	777,61	793,60

Válvula retenedora de presión.

M-M encolar.

Código en PTFE termina en "P" en lugar de "E"

Rango de calibración: 0,5 - 10 bars

Flujómetros / rotámetros

Medidores electrónicos de caudal

Electrodos de pH y ORP

Sensores y transmisores de conductividad

Accesorios y recambios

Medición

INDUSTRIA









FCIV / FCFV

encolar. roscar.

FLOTADOR INOX AISI 316

Diámetro		Ref. Encolar	Ref. Roscar	Escala l/h	€
Encolar	Roscar				
16	3/8"	FC16D1X0030	FC38D1X0030	3-30	86,42
16	3/8"	FC16D1X0040	FC38D1X0040	4-40	86,42
16	3/8"	FC16D1X0100	FC38D1X0100	10-100	86,42
16	3/8"	FC16D1X0200	FC38D1X0200	20-200	86,42
16	3/8"	FC16D1X0300	FC38D1X0300	30-300	86,42
20	1/2"	FC20D1X0050	FC12D1X0050	5-50	90,82
20	1/2"	FC20D1X0100	FC12D1X0100	10-100	90,82
20	1/2"	FC20D1X0160	FC12D1X0160	15-160	90,82
20	1/2"	FC20D1X0250	FC12D1X0250	20-250	90,82
20	1/2"	FC20D1X0350	FC12D1X0350	35-350	90,82
20	1/2"	FC20D1X0600	FC12D1X0600	60-600	90,82
25	3/4"	FC25D1X0150	FC34D1X0150	15-150	95,20
25	3/4"	FC25D1X0250	FC34D1X0250	25-250	95,20
25	3/4"	FC25D1X0400	FC34D1X0400	40-400	95,20
25	3/4"	FC25D1X0600	FC34D1X0600	50-600	95,20
25	3/4"	FC25D1X1100	FC34D1X1100	100-1100	95,20
32	1"	FC32D1X0400	FC10D1X0400	40-400	105,46
32	1"	FC32D1X0600	FC10D1X0600	50-600	105,46
32	1"	FC32D1X1000	FC10D1X1000	100-1000	105,46
32	1"	FC32D1X1500	FC10D1X1500	150-1500	105,46

FLOTADOR PP ROJO

16	3/8"	FC16D1M0015	FC38D1M0015	1,5-15	86,42
16	3/8"	FC16D1M0020	FC38D1M0020	2-20	86,42
16	3/8"	FC16D1M0050	FC38D1M0050	5-50	86,42
16	3/8"	FC16D1M0100	FC38D1M0100	10-100	86,42
16	3/8"	FC16D1M0150	FC38D1M0150	15-150	86,42
20	1/2"	FC20D1M0025	FC12D1M0025	2-25	90,82
20	1/2"	FC20D1M0050	FC12D1M0050	5-50	90,82
20	1/2"	FC20D1M0100	FC12D1M0100	10-100	90,82
20	1/2"	FC20D1M0150	FC12D1M0150	15-150	90,82
20	1/2"	FC20D1M0200	FC12D1M0120	20-200	90,82
20	1/2"	FC20D1M0320	FC12D1M0320	30-320	90,82
25	3/4"	FC25D1M0080	FC34D1M0080	8-80	95,20
25	3/4"	FC25D1M0150	FC34D1M0150	15-150	95,20
25	3/4"	FC25D1M0200	FC34D1M0200	20-200	95,20
25	3/4"	FC25D1M0350	FC34D1M0350	30-350	95,20
25	3/4"	FC25D1M0650	FC34D1M0650	50-650	95,20
32	1"	FC32D1M0200	FC10D1M0200	20-200	105,46
32	1"	FC32D1M0300	FC10D1M0300	30-300	105,46
32	1"	FC32D1M0600	FC10D1M0600	60-600	105,46
32	1"	FC32D1M1000	FC10D1M1000	100-1000	105,46

Flujómetro corto para H₂O.

Densidad: 1 kg/l - 20°C. Cuerpo: TROGAMID. Juntas: EPDM.



FCIV / FCFV

encolar. roscar.

FLOTADOR INOX AISI 316 CON IMÁN INTERIOR incorporado para contacto exterior (suministrado aparte)

S

Diámetro		Ref. Encolar	Ref. Roscar	Escala l/h	€
Encolar	Roscar				
16	3/8"	FC16D1X0030M	FC38D1X0030M	3-30	130,37
16	3/8"	FC16D1X0040M	FC38D1X0040M	4-40	130,37
16	3/8"	FC16D1X0100M	FC38D1X0100M	10-100	130,37
16	3/8"	FC16D1X0200M	FC38D1X0200M	20-200	130,37
16	3/8"	FC16D1X0300M	FC38D1X0300M	30-300	130,37
20	1/2"	FC20D1X0050M	FC12D1X0050M	5-50	133,29
20	1/2"	FC20D1X0100M	FC12D1X0100M	10-100	133,29
20	1/2"	FC20D1X0160M	FC12D1X0160M	15-160	133,29
20	1/2"	FC20D1X0250M	FC12D1X0250M	20-250	133,29
20	1/2"	FC20D1X0350M	FC12D1X0350M	35-350	133,29
20	1/2"	FC20D1X0600M	FC12D1X0600M	60-600	133,29
25	3/4"	FC25D1X0150M	FC34D1X0150M	15-150	139,16
25	3/4"	FC25D1X0250M	FC34D1X0250M	25-250	139,16
25	3/4"	FC25D1X0400M	FC34D1X0400M	40-400	139,16
25	3/4"	FC25D1X0600M	FC34D1X0600M	50-600	139,16
25	3/4"	FC25D1X1100M	FC34D1X1100M	100-1100	139,16
32	1"	FC32D1X0400M	FC10D1X0400M	40-400	156,73
32	1"	FC32D1X0600M	FC10D1X0600M	50-600	156,73
32	1"	FC32D1X1000M	FC10D1X1000M	100-1000	156,73
32	1"	FC32D1X1500M	FC10D1X1500M	150-1500	156,73

FLOTADOR PP ROJO CON IMÁN INTERIOR incorporado para contacto exterior (suministrado aparte)

16	3/8"	FC16D1M0015M	FC38D1M0015M	1,5-15	130,37
16	3/8"	FC16D1M0020M	FC38D1M0020M	2-20	130,37
16	3/8"	FC16D1M0050M	FC38D1M0050M	5-50	130,37
16	3/8"	FC16D1M0100M	FC38D1M0100M	10-100	130,37
16	3/8"	FC16D1M0150M	FC38D1M0150M	15-150	130,37
20	1/2"	FC20D1M0025M	FC12D1M0025M	2-25	133,29
20	1/2"	FC20D1M0050M	FC12D1M0050M	5-50	133,29
20	1/2"	FC20D1M0100M	FC12D1M0100M	10-100	133,29
20	1/2"	FC20D1M0150M	FC12D1M0150M	15-150	133,29
20	1/2"	FC20D1M0200M	FC12D1M0120M	20-200	133,29
20	1/2"	FC20D1M0320M	FC12D1M0320M	30-320	133,29
25	3/4"	FC25D1M0080M	FC34D1M0080M	8-80	139,16
25	3/4"	FC25D1M0150M	FC34D1M0150M	15-150	139,16
25	3/4"	FC25D1M0200M	FC34D1M0200M	20-200	139,16
25	3/4"	FC25D1M0350M	FC34D1M0350M	30-350	139,16
25	3/4"	FC25D1M0650M	FC34D1M0650M	50-650	139,16
32	1"	FC32D1M0200M	FC10D1M0200M	20-200	156,73
32	1"	FC32D1M0300M	FC10D1M0300M	30-300	156,73
32	1"	FC32D1M0600M	FC10D1M0600M	60-600	156,73
32	1"	FC32D1M1000M	FC10D1M1000M	100-1000	156,73

Flujómetro corto para H₂O.

Densidad: 1 kg/l - 20°C. Cuerpo: TROGAMID. Juntas: EPDM.



FCIV / FCFV

encolar. roscar.

FLOTADOR INOX AISI 316

Diámetro		Ref.		Escala l/h	€
Encolar	Roscar	Encolar	Roscar		
16	3/8"	FC16T1X0030	FC38T1X0030	3-30	83,49
16	3/8"	FC16T1X0040	FC38T1X0040	4-40	83,49
16	3/8"	FC16T1X0100	FC38T1X0100	10-100	83,49
16	3/8"	FC16T1X0200	FC38T1X0200	20-200	83,49
16	3/8"	FC16T1X0300	FC38T1X0300	30-300	83,49
20	1/2"	FC20T1X0050	FC12T1X0050	5-50	87,89
20	1/2"	FC20T1X0100	FC12T1X0100	10-100	87,89
20	1/2"	FC20T1X0160	FC12T1X0160	15-160	87,89
20	1/2"	FC20T1X0250	FC12T1X0250	20-250	87,89
20	1/2"	FC20T1X0350	FC12T1X0350	35-350	87,89
20	1/2"	FC20T1X0600	FC12T1X0600	60-600	87,89
25	3/4"	FC25T1X0150	FC34T1X0150	15-150	92,30
25	3/4"	FC25T1X0250	FC34T1X0250	25-250	92,30
25	3/4"	FC25T1X0400	FC34T1X0400	40-400	92,30
25	3/4"	FC25T1X0600	FC34T1X0600	50-600	92,30
25	3/4"	FC25T1X1100	FC34T1X1100	100-1100	92,30
32	1"	FC32T1X0400	FC10T1X0400	40-400	102,55
32	1"	FC32T1X0600	FC10T1X0600	50-600	102,55
32	1"	FC32T1X1000	FC10T1X1000	100-1000	102,55
32	1"	FC32T1X1500	FC10T1X1500	150-1500	102,55

FLOTADOR PP ROJO

16	3/8"	FC16T1M0015	FC38T1M0015	1,5-15	83,49
16	3/8"	FC16T1M0020	FC38T1M0020	2-20	83,49
16	3/8"	FC16T1M0050	FC38T1M0050	5-50	83,49
16	3/8"	FC16T1M0100	FC38T1M0100	10-100	83,49
16	3/8"	FC16T1M0150	FC38T1M0150	15-150	83,49
20	1/2"	FC20T1M0025	FC12T1M0025	2-25	87,89
20	1/2"	FC20T1M0050	FC12T1M0050	5-50	87,89
20	1/2"	FC20T1M0100	FC12T1M0100	10-100	87,89
20	1/2"	FC20T1M0150	FC12T1M0150	15-150	87,89
20	1/2"	FC20T1M0200	FC12T1M0200	20-200	87,89
20	1/2"	FC20T1M0320	FC12T1M0320	30-320	87,89
25	3/4"	FC25T1M0080	FC34T1M0080	8-80	92,30
25	3/4"	FC25T1M0150	FC34T1M0150	15-150	92,30
25	3/4"	FC25T1M0200	FC34T1M0200	20-200	92,30
25	3/4"	FC25T1M0350	FC34T1M0350	30-350	92,30
25	3/4"	FC25T1M0650	FC34T1M0650	50-650	92,30
32	1"	FC32T1M0200	FC10T1M0200	20-200	102,55
32	1"	FC32T1M0300	FC10T1M0300	30-300	102,55
32	1"	FC32T1M0600	FC10T1M0600	60-600	102,55
32	1"	FC32T1M1000	FC10T1M1000	100-1000	102,55

Flujómetro corto para **H₂O**.

Densidad: 1 kg/l - 20°C. Cuerpo: **PVC Transparente**. Juntas: **EPDM**.



FCIV / FCFV

encolar. roscar.

FLOTADOR INOX AISI 316 CON IMÁN INTERIOR incorporado para contacto exterior (suministrado aparte)

S

Diámetro		Ref. Encolar	Ref. Roscar	Escala l/h	€
Encolar	Roscar				
16	3/8"	FC16T1X0030M	FC38T1X0030M	3-30	127,43
16	3/8"	FC16T1X0040M	FC38T1X0040M	4-40	127,43
16	3/8"	FC16T1X0100M	FC38T1X0100M	10-100	127,43
16	3/8"	FC16T1X0200M	FC38T1X0200M	20-200	127,43
16	3/8"	FC16T1X0300M	FC38T1X0300M	30-300	127,43
20	1/2"	FC20T1X0050M	FC12T1X0050M	5-50	130,37
20	1/2"	FC20T1X0100M	FC12T1X0100M	10-100	130,37
20	1/2"	FC20T1X0160M	FC12T1X0160M	15-160	130,37
20	1/2"	FC20T1X0250M	FC12T1X0250M	20-250	130,37
20	1/2"	FC20T1X0350M	FC12T1X0350M	35-350	130,37
20	1/2"	FC20T1X0600M	FC12T1X0600M	60-600	130,37
25	3/4"	FC25T1X0150M	FC34T1X0150M	15-150	136,23
25	3/4"	FC25T1X0250M	FC34T1X0250M	25-250	136,23
25	3/4"	FC25T1X0400M	FC34T1X0400M	40-400	136,23
25	3/4"	FC25T1X0600M	FC34T1X0600M	50-600	136,23
25	3/4"	FC25T1X1100M	FC34T1X1100M	100-1100	136,23
32	1"	FC32T1X0400M	FC10T1X0400M	40-400	153,80
32	1"	FC32T1X0600M	FC10T1X0600M	50-600	153,80
32	1"	FC32T1X1000M	FC10T1X1000M	100-1000	153,80
32	1"	FC32T1X1500M	FC10T1X1500M	150-1500	153,80

FLOTADOR PP ROJO CON IMÁN INTERIOR incorporado para contacto exterior (suministrado aparte)

16	3/8"	FC16T1M0015M	FC38T1M0015M	1,5-15	127,43
16	3/8"	FC16T1M0020M	FC38T1M0020M	2-20	127,43
16	3/8"	FC16T1M0050M	FC38T1M0050M	5-50	127,43
16	3/8"	FC16T1M0100M	FC38T1M0100M	10-100	127,43
16	3/8"	FC16T1M0150M	FC38T1M0150M	15-150	127,43
20	1/2"	FC20T1M0025M	FC12T1M0025M	2-25	130,37
20	1/2"	FC20T1M0050M	FC12T1M0050M	5-50	130,37
20	1/2"	FC20T1M0100M	FC12T1M0100M	10-100	130,37
20	1/2"	FC20T1M0150M	FC12T1M0150M	15-150	130,37
20	1/2"	FC20T1M0200M	FC12T1M0200M	20-200	130,37
20	1/2"	FC20T1M0320M	FC12T1M0320M	30-320	130,37
25	3/4"	FC25T1M0080M	FC34T1M0080M	8-80	136,23
25	3/4"	FC25T1M0150M	FC34T1M0150M	15-150	136,23
25	3/4"	FC25T1M0200M	FC34T1M0200M	20-200	136,23
25	3/4"	FC25T1M0350M	FC34T1M0350M	30-350	136,23
25	3/4"	FC25T1M0650M	FC34T1M0650M	50-650	136,23
32	1"	FC32T1M0200M	FC10T1M0200M	20-200	153,80
32	1"	FC32T1M0300M	FC10T1M0300M	30-300	153,80
32	1"	FC32T1M0600M	FC10T1M0600M	60-600	153,80
32	1"	FC32T1M1000M	FC10T1M1000M	100-1000	153,80

Flujómetro corto para **H₂O**.

Densidad: 1 kg/l - 20°C. Cuerpo: **PVC Transparente**. Juntas: **EPDM**.



FCIV / FCFV

encolar. roscar.

FLOTADOR INOX AISI 316

Diámetro		Ref.		Escala l/h	€
Encolar	Roscar	Encolar	Roscar		
16	3/8"	FC16P1X0030	FC38P1X0030	3-30	95,20
16	3/8"	FC16P1X0040	FC38P1X0040	4-40	95,20
16	3/8"	FC16P1X0100	FC38P1X0100	10-100	95,20
16	3/8"	FC16P1X0200	FC38P1X0200	20-200	95,20
16	3/8"	FC16P1X0300	FC38P1X0300	30-300	95,20
20	1/2"	FC20P1X0050	FC12P1X0050	5-50	101,08
20	1/2"	FC20P1X0100	FC12P1X0100	10-100	101,08
20	1/2"	FC20P1X0160	FC12P1X0160	15-160	101,08
20	1/2"	FC20P1X0250	FC12P1X0250	20-250	101,08
20	1/2"	FC20P1X0350	FC12P1X0350	35-350	101,08
20	1/2"	FC20P1X0600	FC12P1X0600	60-600	101,08
25	3/4"	FC25P1X0150	FC34P1X0150	15-150	108,40
25	3/4"	FC25P1X0250	FC34P1X0250	25-250	108,40
25	3/4"	FC25P1X0400	FC34P1X0400	40-400	108,40
25	3/4"	FC25P1X0600	FC34P1X0600	50-600	108,40
25	3/4"	FC25P1X1100	FC34P1X1100	100-1100	108,40
32	1"	FC32P1X0400	FC10P1X0400	40-400	121,59
32	1"	FC32P1X0600	FC10P1X0600	50-600	121,59
32	1"	FC32P1X1000	FC10P1X1000	100-1000	121,59
32	1"	FC32P1X1500	FC10P1X1500	150-1500	121,59

FLOTADOR PP ROJO

16	3/8"	FC16P1M0015	FC38P1M0015	1,5-15	95,20
16	3/8"	FC16P1M0020	FC38P1M0020	2-20	95,20
16	3/8"	FC16P1M0050	FC38P1M0050	5-50	95,20
16	3/8"	FC16P1M0100	FC38P1M0100	10-100	95,20
16	3/8"	FC16P1M0150	FC38P1M0150	15-150	95,20
20	1/2"	FC20P1M0025	FC12P1M0025	2-25	101,08
20	1/2"	FC20P1M0050	FC12P1M0050	5-50	101,08
20	1/2"	FC20P1M0100	FC12P1M0100	10-100	101,08
20	1/2"	FC20P1M0150	FC12P1M0150	15-150	101,08
20	1/2"	FC20P1M0200	FC12P1M0200	20-200	101,08
20	1/2"	FC20P1M0320	FC12P1M0320	30-320	101,08
25	3/4"	FC25P1M0080	FC34P1M0080	8-80	108,40
25	3/4"	FC25P1M0150	FC34P1M0150	15-150	108,40
25	3/4"	FC25P1M0200	FC34P1M0200	20-200	108,40
25	3/4"	FC25P1M0350	FC34P1M0350	30-350	108,40
25	3/4"	FC25P1M0650	FC34P1M0650	50-650	108,40
32	1"	FC32P1M0200	FC10P1M0200	20-200	121,59
32	1"	FC32P1M0300	FC10P1M0300	30-300	121,59
32	1"	FC32P1M0600	FC10P1M0600	60-600	121,59
32	1"	FC32P1M1000	FC10P1M1000	100-1000	121,59

Flujómetro corto para H₂O.

Densidad: 1 kg/l - 20°C. Cuerpo: POLYSULFON. Juntas: EPDM.



FCIV / FCFV

encolar. roscar.

FLOTADOR INOX AISI 316 CON IMÁN INTERIOR incorporado para contacto exterior (suministrado aparte)

S

Diámetro		Ref. Encolar	Ref. Roscar	Escala l/h	€
Encolar	Roscar				
16	3/8"	FC16P1X0030M	FC38P1X0030M	3-30	140,62
16	3/8"	FC16P1X0040M	FC38P1X0040M	4-40	140,62
16	3/8"	FC16P1X0100M	FC38P1X0100M	10-100	140,62
16	3/8"	FC16P1X0200M	FC38P1X0200M	20-200	140,62
16	3/8"	FC16P1X0300M	FC38P1X0300M	30-300	140,62
20	1/2"	FC20P1X0050M	FC12P1X0050M	5-50	145,01
20	1/2"	FC20P1X0100M	FC12P1X0100M	10-100	145,01
20	1/2"	FC20P1X0160M	FC12P1X0160M	15-160	145,01
20	1/2"	FC20P1X0250M	FC12P1X0250M	20-250	145,01
20	1/2"	FC20P1X0350M	FC12P1X0350M	35-350	145,01
20	1/2"	FC20P1X0600M	FC12P1X0600M	60-600	145,01
25	3/4"	FC25P1X0150M	FC34P1X0150M	15-150	152,34
25	3/4"	FC25P1X0250M	FC34P1X0250M	25-250	152,34
25	3/4"	FC25P1X0400M	FC34P1X0400M	40-400	152,34
25	3/4"	FC25P1X0600M	FC34P1X0600M	50-600	152,34
25	3/4"	FC25P1X1100M	FC34P1X1100M	100-1100	152,34
32	1"	FC32P1X0400M	FC10P1X0400M	40-400	172,84
32	1"	FC32P1X0600M	FC10P1X0600M	50-600	172,84
32	1"	FC32P1X1000M	FC10P1X1000M	100-1000	172,84
32	1"	FC32P1X1500M	FC10P1X1500M	150-1500	172,84

FLOTADOR PP ROJO CON IMÁN INTERIOR incorporado para contacto exterior (suministrado aparte)

16	3/8"	FC16P1M0015M	FC38P1M0015M	1,5-15	140,62
16	3/8"	FC16P1M0020M	FC38P1M0020M	2-20	140,62
16	3/8"	FC16P1M0050M	FC38P1M0050M	5-50	140,62
16	3/8"	FC16P1M0100M	FC38P1M0100M	10-100	140,62
16	3/8"	FC16P1M0150M	FC38P1M0150M	15-150	140,62
20	1/2"	FC20P1M0025M	FC12P1M0025M	2-25	145,01
20	1/2"	FC20P1M0050M	FC12P1M0050M	5-50	145,01
20	1/2"	FC20P1M0100M	FC12P1M0100M	10-100	145,01
20	1/2"	FC20P1M0150M	FC12P1M0150M	15-150	145,01
20	1/2"	FC20P1M0200M	FC12P1M0200M	20-200	145,01
20	1/2"	FC20P1M0320M	FC12P1M0320M	30-320	145,01
25	3/4"	FC25P1M0080M	FC34P1M0080M	8-80	152,34
25	3/4"	FC25P1M0150M	FC34P1M0150M	15-150	152,34
25	3/4"	FC25P1M0200M	FC34P1M0200M	20-200	152,34
25	3/4"	FC25P1M0350M	FC34P1M0350M	30-350	152,34
25	3/4"	FC25P1M0650M	FC34P1M0650M	50-650	152,34
32	1"	FC32P1M0200M	FC10P1M0200M	20-200	172,84
32	1"	FC32P1M0300M	FC10P1M0300M	30-300	172,84
32	1"	FC32P1M0600M	FC10P1M0600M	60-600	172,84
32	1"	FC32P1M1000M	FC10P1M1000M	100-1000	172,84

Flujómetro corto para **H₂O**.

Densidad: 1 kg/l - 20°C. Cuerpo: **POLYSULFON**. Juntas: **EPDM**.



FCIV / FCFV

encolar. roscar.

FLOTADOR INOX AISI 316

Diámetro					
Encolar	Roscar	Ref. Encolar	Ref. Roscar	Escala l/h	€
16	3/8"	FC16T3X0085	FC38T3X0085	0,5-8,5	83,49
16	3/8"	FC16T3X0040	FC38T3X0040	2,5-40	83,49
16	3/8"	FC16T3X0120	FC38T3X0120	10-120	83,49
16	3/8"	FC16T3X0180	FC38T3X0180	15-180	83,49
20	1/2"	FC20T3X0375	FC12T3X0375	2,5-37,5	87,89
20	1/2"	FC20T3X0075	FC12T3X0075	4-75	87,89
20	1/2"	FC20T3X0140	FC12T3X0140	5-140	87,89
20	1/2"	FC20T3X0220	FC12T3X0220	9-220	87,89
20	1/2"	FC20T3X0360	FC12T3X0360	24-360	87,89
25	3/4"	FC25T3X0135	FC34T3X0135	6-135	92,30
25	3/4"	FC25T3X0230	FC34T3X0230	13-230	92,30
25	3/4"	FC25T3X0350	FC34T3X0350	20-350	92,30
25	3/4"	FC25T3X0650	FC34T3X0650	25-650	92,30
32	1"	FC32T3X0220	FC10T3X0220	10-220	102,55
32	1"	FC32T3X0350	FC10T3X0350	20-350	102,55
32	1"	FC32T3X0650	FC10T3X0650	25-650	102,55
32	1"	FC32T3X1000	FC10T3X1000	50-1000	102,55

FLOTADOR PP ROJO

16	3/8"	FC16T3M0003	FC38T3M0003	0,25-3	83,49
16	3/8"	FC16T3M0017	FC38T3M0017	1-17	83,49
16	3/8"	FC16T3M0045	FC38T3M0045	2,5-45	83,49
16	3/8"	FC16T3M0075	FC38T3M0075	5-75	83,49
20	1/2"	FC20T3M0125	FC12T3M0125	1-12,5	87,89
20	1/2"	FC20T3M0034	FC12T3M0034	2-34	87,89
20	1/2"	FC20T3M0063	FC12T3M0063	2,5-63	87,89
20	1/2"	FC20T3M0104	FC12T3M0104	5-104	87,89
20	1/2"	FC20T3M0170	FC12T3M0170	10-170	87,89
25	3/4"	FC25T3M0060	FC34T3M0060	3,5-60	92,30
25	3/4"	FC25T3M0092	FC34T3M0092	5-92	92,30
25	3/4"	FC25T3M0165	FC34T3M0165	8-165	92,30
25	3/4"	FC25T3M0380	FC34T3M0380	20-380	92,30
32	1"	FC32T3M0090	FC10T3M0090	5-90	102,55
32	1"	FC32T3M0150	FC10T3M0150	7,5-150	102,55
32	1"	FC32T3M0360	FC10T3M0360	20-360	102,55
32	1"	FC32T3M0650	FC10T3M0650	25-650	102,55

Flujómetro corto para **Hidróxido de sodio (NaOH) 30%**.

Densidad: 1,33 kg/l - 20°C. Cuerpo: **PVC Transparente**. Juntas: **EPDM**.



FCIV / FCFV

encolar. roscar.

FLOTADOR INOX AISI 316 CON IMÁN INTERIOR incorporado para contacto exterior (suministrado aparte)

S

Diámetro		Ref.		Escala l/h	€
Encolar	Roscar	Encolar	Roscar		
16	3/8"	FC16T3X0085M	FC38T3X0085M	0,5-8,5	127,43
16	3/8"	FC16T3X0040M	FC38T3X0040M	2,5-40	127,43
16	3/8"	FC16T3X0120M	FC38T3X0120M	10-120	127,43
16	3/8"	FC16T3X0180M	FC38T3X0180M	15-180	127,43
20	1/2"	FC20T3X0375M	FC12T3X0375M	2,5-37,5	130,37
20	1/2"	FC20T3X0075M	FC12T3X0075M	4-75	130,37
20	1/2"	FC20T3X0140M	FC12T3X0140M	5-140	130,37
20	1/2"	FC20T3X0220M	FC12T3X0220M	9-220	130,37
20	1/2"	FC20T3X0360M	FC12T3X0360M	24-360	130,37
25	3/4"	FC25T3X0135M	FC34T3X0135M	6-135	136,23
25	3/4"	FC25T3X0230M	FC34T3X0230M	13-230	136,23
25	3/4"	FC25T3X0350M	FC34T3X0350M	20-350	136,23
25	3/4"	FC25T3X0650M	FC34T3X0650M	25-650	136,23
32	1"	FC32T3X0220M	FC10T3X0220M	10-220	153,80
32	1"	FC32T3X0350M	FC10T3X0350M	20-350	153,80
32	1"	FC32T3X0650M	FC10T3X0650M	25-650	153,80
32	1"	FC32T3X1000M	FC10T3X1000M	50-1000	153,80

FLOTADOR PP ROJO CON IMÁN INTERIOR incorporado para contacto exterior (suministrado aparte)

16	3/8"	FC16T3M0003M	FC38T3M0003M	0,25-3	127,43
16	3/8"	FC16T3M0017M	FC38T3M0017M	1-17	127,43
16	3/8"	FC16T3M0045M	FC38T3M0045M	2,5-45	127,43
16	3/8"	FC16T3M0075M	FC38T3M0075M	5-75	127,43
20	1/2"	FC20T3M0125M	FC12T3M0125M	1-12,5	130,37
20	1/2"	FC20T3M0034M	FC12T3M0034M	2-34	130,37
20	1/2"	FC20T3M0063M	FC12T3M0063M	2,5-63	130,37
20	1/2"	FC20T3M0104M	FC12T3M0104M	5-104	130,37
20	1/2"	FC20T3M0170M	FC12T3M0170M	10-170	130,37
25	3/4"	FC25T3M0060M	FC34T3M0060M	3,5-60	136,23
25	3/4"	FC25T3M0092M	FC34T3M0092M	5-92	136,23
25	3/4"	FC25T3M0165M	FC34T3M0165M	8-165	136,23
25	3/4"	FC25T3M0380M	FC34T3M0380M	20-380	136,23
32	1"	FC32T3M0090M	FC10T3M0090M	5-90	153,80
32	1"	FC32T3M0150M	FC10T3M0150M	7,5-150	153,80
32	1"	FC32T3M0360M	FC10T3M0360M	20-360	153,80
32	1"	FC32T3M0650M	FC10T3M0650M	25-650	153,80

Flujómetro corto para **Hidróxido de sodio (NaOH) 30%**.

Densidad: 1,33 kg/l - 20°C. Cuerpo: **PVC Transparente**. Juntas: **EPDM**.



FCIV / FCFV

encolar. roscar.

FLOTADOR INOX AISI 316

Diámetro						
Encolar	Roscar	Ref. Encolar	Ref. Roscar	Escala l/h		€
16	3/8"	FC16P3X0085	FC38P3X0085	0,5-8,5		95,20
16	3/8"	FC16P3X0040	FC38P3X0040	2,5-40		95,20
16	3/8"	FC16P3X0120	FC38P3X0120	10-120		95,20
16	3/8"	FC16P3X0180	FC38P3X0180	15-180		95,20
20	1/2"	FC20P3X0375	FC12P3X0375	2,5-37,5		101,08
20	1/2"	FC20P3X0075	FC12P3X0075	4-75		101,08
20	1/2"	FC20P3X0140	FC12P3X0140	5-140		101,08
20	1/2"	FC20P3X0220	FC12P3X0220	9-220		101,08
20	1/2"	FC20P3X0360	FC12P3X0360	24-360		101,08
25	3/4"	FC25P3X0135	FC34P3X0135	6-135		108,40
25	3/4"	FC25P3X0230	FC34P3X0230	13-230		108,40
25	3/4"	FC25P3X0350	FC34P3X0350	20-350		108,40
25	3/4"	FC25P3X0650	FC34P3X0650	25-650		108,40
32	1"	FC32P3X0220	FC10P3X0220	10-220		121,59
32	1"	FC32P3X0350	FC10P3X0350	20-350		121,59
32	1"	FC32P3X0650	FC10P3X0650	25-650		121,59
32	1"	FC32P3X1000	FC10P3X1000	50-1000		121,59

FLOTADOR PP ROJO

16	3/8"	FC16P3M0003	FC38P3M0003	0,25-3		95,20
16	3/8"	FC16P3M0017	FC38P3M0017	1-17		95,20
16	3/8"	FC16P3M0045	FC38P3M0045	2,5-45		95,20
16	3/8"	FC16P3M0075	FC38P3M0075	5-75		95,20
20	1/2"	FC20P3M0125	FC12P3M0125	1-12,5		101,08
20	1/2"	FC20P3M0034	FC12P3M0034	2-34		101,08
20	1/2"	FC20P3M0063	FC12P3M0063	2,5-63		101,08
20	1/2"	FC20P3M0104	FC12P3M0104	5-104		101,08
20	1/2"	FC20P3M0170	FC12P3M0170	10-170		101,08
25	3/4"	FC25P3M0060	FC34P3M0060	3,5-60		108,40
25	3/4"	FC25P3M0092	FC34P3M0092	5-92		108,40
25	3/4"	FC25P3M0165	FC34P3M0165	8-165		108,40
25	3/4"	FC25P3M0380	FC34P3M0380	20-380		108,40
32	1"	FC32P3M0090	FC10P3M0090	5-90		121,59
32	1"	FC32P3M0150	FC10P3M0150	7,5-150		121,59
32	1"	FC32P3M0360	FC10P3M0360	20-360		121,59
32	1"	FC32P3M0650	FC10P3M0650	25-650		121,59

Flujómetro corto para **Hidróxido de sodio (NaOH) 30%**.

Densidad: 1,33 kg/l - 20°C. Cuerpo: **POLYSULFON**. Juntas: **EPDM**.



FCIV / FCFV

encolar. roscar.

FLOTADOR INOX AISI 316 CON IMÁN INTERIOR incorporado para contacto exterior (suministrado aparte)

S

Diámetro		Ref.		Escala l/h	€
Encolar	Roscar	Encolar	Roscar		
16	3/8"	FC16P3X0085M	FC38P3X0085M	0,5-8,5	140,62
16	3/8"	FC16P3X0040M	FC38P3X0040M	2,5-40	140,62
16	3/8"	FC16P3X0120M	FC38P3X0120M	10-120	140,62
16	3/8"	FC16P3X0180M	FC38P3X0180M	15-180	140,62
20	1/2"	FC20P3X0375M	FC12P3X0375M	2,5-37,5	145,01
20	1/2"	FC20P3X0075M	FC12P3X0075M	4-75	145,01
20	1/2"	FC20P3X0140M	FC12P3X0140M	5-140	145,01
20	1/2"	FC20P3X0220M	FC12P3X0220M	9-220	145,01
20	1/2"	FC20P3X0360M	FC12P3X0360M	24-360	145,01
25	3/4"	FC25P3X0135M	FC34P3X0135M	6-135	152,34
25	3/4"	FC25P3X0230M	FC34P3X0230M	13-230	152,34
25	3/4"	FC25P3X0350M	FC34P3X0350M	20-350	152,34
25	3/4"	FC25P3X0650M	FC34P3X0650M	25-650	152,34
32	1"	FC32P3X0220M	FC10P3X0220M	10-220	172,84
32	1"	FC32P3X0350M	FC10P3X0350M	20-350	172,84
32	1"	FC32P3X0650M	FC10P3X0650M	25-650	172,84
32	1"	FC32P3X1000M	FC10P3X1000M	50-1000	172,84

FLOTADOR PP ROJO CON IMÁN INTERIOR incorporado para contacto exterior (suministrado aparte)

16	3/8"	FC16P3M0003M	FC38P3M0003M	0,25-3	140,62
16	3/8"	FC16P3M0017M	FC38P3M0017M	1-17	140,62
16	3/8"	FC16P3M0045M	FC38P3M0045M	2,5-45	140,62
16	3/8"	FC16P3M0075M	FC38P3M0075M	5-75	140,62
20	1/2"	FC20P3M0125M	FC12P3M0125M	1-12,5	145,01
20	1/2"	FC20P3M0034M	FC12P3M0034M	2-34	145,01
20	1/2"	FC20P3M0063M	FC12P3M0063M	2,5-63	145,01
20	1/2"	FC20P3M0104M	FC12P3M0104M	5-104	145,01
20	1/2"	FC20P3M0170M	FC12P3M0170M	10-170	145,01
25	3/4"	FC25P3M0060M	FC34P3M0060M	3,5-60	152,34
25	3/4"	FC25P3M0092M	FC34P3M0092M	5-92	152,34
25	3/4"	FC25P3M0165M	FC34P3M0165M	8-165	152,34
25	3/4"	FC25P3M0380M	FC34P3M0380M	20-380	152,34
32	1"	FC32P3M0090M	FC10P3M0090M	5-90	172,84
32	1"	FC32P3M0150M	FC10P3M0150M	7,5-150	172,84
32	1"	FC32P3M0360M	FC10P3M0360M	20-360	172,84
32	1"	FC32P3M0650M	FC10P3M0650M	25-650	172,84

Flujómetro corto para **Hidróxido de sodio (NaOH) 30%**.

Densidad: 1,33 kg/l - 20°C. Cuerpo: POLYSULFON. Juntas: EPDM.



FCIV / FCFV

encolar. roscar.

FLOTADOR INOX AISI 316

Diámetro		Ref.		Escala l/h	€
Encolar	Roscar	Encolar	Roscar		
16	3/8"	FC16T5X0014	FC38T5X0014	0,05-1,4	83,49
16	3/8"	FC16T5X0008	FC38T5X0008	0,5-8	83,49
16	3/8"	FC16T5X0040	FC38T5X0040	2,5-40	83,49
16	3/8"	FC16T5X0055	FC38T5X0055	4-55	83,49
20	1/2"	FC20T5X0065	FC12T5X0065	0,25-6,5	87,89
20	1/2"	FC20T5X0015	FC12T5X0015	1-15	87,89
20	1/2"	FC20T5X0036	FC12T5X0036	2-36	87,89
20	1/2"	FC20T5X0075	FC12T5X0075	4-75	87,89
20	1/2"	FC20T5X0140	FC12T5X0140	6-140	87,89
25	3/4"	FC25T5X0030	FC34T5X0030	2,5-30	92,30
25	3/4"	FC25T5X0065	FC34T5X0065	3-65	92,30
25	3/4"	FC25T5X0135	FC34T5X0135	4-135	92,30
25	3/4"	FC25T5X0320	FC34T5X0320	20-320	92,30
32	1"	FC32T5X0055	FC10T5X0055	2,5-55	102,55
32	1"	FC32T5X0125	FC10T5X0125	5-125	102,55
32	1"	FC32T5X0300	FC10T5X0300	20-300	102,55
32	1"	FC32T5X0600	FC10T5X0600	25-600	102,55

FLOTADOR PP ROJO

16	3/8"	FC16T5M0005	FC38T5M0005	0,025-0,5	83,49
16	3/8"	FC16T5M0275	FC38T5M0275	0,25-2,75	83,49
16	3/8"	FC16T5M0009	FC38T5M0009	0,5-9	83,49
16	3/8"	FC16T5M0021	FC38T5M0021	1-21	83,49
20	1/2"	FC20T5M0002	FC12T5M0002	0,1-2	87,89
20	1/2"	FC20T5M0055	FC12T5M0055	0,25-5,5	87,89
20	1/2"	FC20T5M0125	FC12T5M0125	0,5-12,5	87,89
20	1/2"	FC20T5M0255	FC12T5M0255	2-25,5	87,89
20	1/2"	FC20T5M0475	FC12T5M0475	2,5-47,5	87,89
25	3/4"	FC25T5M0010	FC34T5M0010	1-10	92,30
25	3/4"	FC25T5M0019	FC34T5M0019	1-19	92,30
25	3/4"	FC25T5M0045	FC34T5M0045	2-45	92,30
25	3/4"	FC25T5M0130	FC34T5M0130	4-130	92,30
32	1"	FC32T5M0015	FC10T5M0015	1-15	102,55
32	1"	FC32T5M0040	FC10T5M0040	2-40	102,55
32	1"	FC32T5M0110	FC10T5M0110	5-110	102,55
32	1"	FC32T5M0260	FC10T5M0260	10-260	102,55

Flujómetro corto para **Hidróxido de sodio (NaOH) 50%**.

Densidad: 1,53 kg/l - 20°C. Cuerpo: **PVC Transparente**. Juntas: **EPDM**.



FCIV / FCFV

encolar. roscar.

FLOTADOR INOX AISI 316 CON IMÁN INTERIOR incorporado para contacto exterior (suministrado aparte)

S

Diámetro		Ref.		Escala l/h	€
Encolar	Roscar	Encolar	Roscar		
16	3/8"	FC16T5X0014M	FC38T5X0014M	0,05-1,4	127,43
16	3/8"	FC16T5X0008M	FC38T5X0008M	0,5-8	127,43
16	3/8"	FC16T5X0040M	FC38T5X0040M	2,5-40	127,43
16	3/8"	FC16T5X0055M	FC38T5X0055M	4-55	127,43
20	1/2"	FC20T5X0065M	FC12T5X0065M	0,25-6,5	130,37
20	1/2"	FC20T5X0015M	FC12T5X0015M	1-15	130,37
20	1/2"	FC20T5X0036M	FC12T5X0036M	2-36	130,37
20	1/2"	FC20T5X0075M	FC12T5X0075M	4-75	130,37
20	1/2"	FC20T5X0140M	FC12T5X0140M	6-140	130,37
25	3/4"	FC25T5X0030M	FC34T5X0030M	2,5-30	136,23
25	3/4"	FC25T5X0065M	FC34T5X0065M	3-65	136,23
25	3/4"	FC25T5X0135M	FC34T5X0135M	4-135	136,23
25	3/4"	FC25T5X0320M	FC34T5X0320M	20-320	136,23
32	1"	FC32T5X0055M	FC10T5X0055M	2,5-55	153,80
32	1"	FC32T5X0125M	FC10T5X0125M	5-125	153,80
32	1"	FC32T5X0300M	FC10T5X0300M	20-300	153,80
32	1"	FC32T5X0600M	FC10T5X0600M	25-600	153,80

FLOTADOR PP ROJO CON IMÁN INTERIOR incorporado para contacto exterior (suministrado aparte)

16	3/8"	FC16T5M0005M	FC38T5M0005M	0,025-0,5	127,43
16	3/8"	FC16T5M0275M	FC38T5M0275M	0,25-2,75	127,43
16	3/8"	FC16T5M0009M	FC38T5M0009M	0,5-9	127,43
16	3/8"	FC16T5M0021M	FC38T5M0021M	1-21	127,43
20	1/2"	FC20T5M0002M	FC12T5M0002M	0,1-2	130,37
20	1/2"	FC20T5M0055M	FC12T5M0055M	0,25-5,5	130,37
20	1/2"	FC20T5M0125M	FC12T5M0125M	0,5-12,5	130,37
20	1/2"	FC20T5M0255M	FC12T5M0255M	2-25,5	130,37
20	1/2"	FC20T5M0475M	FC12T5M0475M	2,5-47,5	130,37
25	3/4"	FC25T5M0010M	FC34T5M0010M	1-10	136,23
25	3/4"	FC25T5M0019M	FC34T5M0019M	1-19	136,23
25	3/4"	FC25T5M0045M	FC34T5M0045M	2-45	136,23
25	3/4"	FC25T5M0130M	FC34T5M0130M	4-130	136,23
32	1"	FC32T5M0015M	FC10T5M0015M	1-15	153,80
32	1"	FC32T5M0040M	FC10T5M0040M	2-40	153,80
32	1"	FC32T5M0110M	FC10T5M0110M	5-110	153,80
32	1"	FC32T5M0260M	FC10T5M0260M	10-260	153,80

Flujómetro corto para **Hidróxido de sodio (NaOH) 50%**.

Densidad: 1,53 kg/l - 20°C. Cuerpo: **PVC Transparente**. Juntas: **EPDM**.



FCIV / FCFV

encolar. roscar.

FLOTADOR INOX AISI 316

Diámetro		Ref.		Escala l/h	€
Encolar	Roscar	Encolar	Roscar		
16	3/8"	FC16P5X0014	FC38P5X0014	0,05-1,4	95,20
16	3/8"	FC16P5X0008	FC38P5X0008	0,5-8	95,20
16	3/8"	FC16P5X0040	FC38P5X0040	2,5-40	95,20
16	3/8"	FC16P5X0055	FC38P5X0055	4-55	95,20
20	1/2"	FC20P5X0065	FC12P5X0065	0,25-6,5	101,08
20	1/2"	FC20P5X0015	FC12P5X0015	1-15	101,08
20	1/2"	FC20P5X0036	FC12P5X0036	2-36	101,08
20	1/2"	FC20P5X0075	FC12P5X0075	4-75	101,08
20	1/2"	FC20P5X0140	FC12P5X0140	6-140	101,08
25	3/4"	FC25P5X0030	FC34P5X0030	2,5-30	108,40
25	3/4"	FC25P5X0065	FC34P5X0065	3-65	108,40
25	3/4"	FC25P5X0135	FC34P5X0135	4-135	108,40
25	3/4"	FC25P5X0320	FC34P5X0320	20-320	108,40
32	1"	FC32P5X0055	FC10P5X0055	2,5-55	121,59
32	1"	FC32P5X0125	FC10P5X0125	5-125	121,59
32	1"	FC32P5X0300	FC10P5X0300	20-300	121,59
32	1"	FC32P5X0600	FC10P5X0600	25-600	121,59

FLOTADOR PP ROJO

16	3/8"	FC16P5M0005	FC38P5M0005	0,025-0,5	95,20
16	3/8"	FC16P5M0275	FC38P5M0275	0,25-2,75	95,20
16	3/8"	FC16P5M0009	FC38P5M0009	0,5-9	95,20
16	3/8"	FC16P5M0021	FC38P5M0021	1-21	95,20
20	1/2"	FC20P5M0002	FC12P5M0002	0,1-2	101,08
20	1/2"	FC20P5M0055	FC12P5M0055	0,25-5,5	101,08
20	1/2"	FC20P5M0125	FC12P5M0125	0,5-12,5	101,08
20	1/2"	FC20P5M0255	FC12P5M0255	2-25,5	101,08
20	1/2"	FC20P5M0475	FC12P5M0475	2,5-47,5	101,08
25	3/4"	FC25P5M0010	FC34P5M0010	1-10	108,40
25	3/4"	FC25P5M0019	FC34P5M0019	1-19	108,40
25	3/4"	FC25P5M0045	FC34P5M0045	2-45	108,40
25	3/4"	FC25P5M0130	FC34P5M0130	4-130	108,40
32	1"	FC32P5M0015	FC10P5M0015	1-15	121,59
32	1"	FC32P5M0040	FC10P5M0040	2-40	121,59
32	1"	FC32P5M0110	FC10P5M0110	5-110	121,59
32	1"	FC32P5M0260	FC10P5M0260	10-260	121,59

Flujómetro corto para **Hidróxido de sodio (NaOH) 50%**.

Densidad: 1,53 kg/l - 20°C. Cuerpo: **POLYSULFON**. Juntas: **EPDM**.



FCIV / FCFV

encolar. roscar.

FLOTADOR INOX AISI 316 CON IMÁN INTERIOR incorporado para contacto exterior (suministrado aparte)

S

Diámetro		Ref. Encolar	Ref. Roscar	Escala l/h	€
Encolar	Roscar				
16	3/8"	FC16P5X0014M	FC38P5X0014M	0,05-1,4	140,62
16	3/8"	FC16P5X0008M	FC38P5X0008M	0,5-8	140,62
16	3/8"	FC16P5X0040M	FC38P5X0040M	2,5-40	140,62
16	3/8"	FC16P5X0055M	FC38P5X0055M	4-55	140,62
20	1/2"	FC20P5X0065M	FC12P5X0065M	0,25-6,5	145,01
20	1/2"	FC20P5X0015M	FC12P5X0015M	1-15	145,01
20	1/2"	FC20P5X0036M	FC12P5X0036M	2-36	145,01
20	1/2"	FC20P5X0075M	FC12P5X0075M	4-75	145,01
20	1/2"	FC20P5X0140M	FC12P5X0140M	6-140	145,01
25	3/4"	FC25P5X0030M	FC34P5X0030M	2,5-30	152,34
25	3/4"	FC25P5X0065M	FC34P5X0065M	3-65	152,34
25	3/4"	FC25P5X0135M	FC34P5X0135M	4-135	152,34
25	3/4"	FC25P5X0320M	FC34P5X0320M	20-320	152,34
32	1"	FC32P5X0055M	FC10P5X0055M	2,5-55	172,84
32	1"	FC32P5X0125M	FC10P5X0125M	5-125	172,84
32	1"	FC32P5X0300M	FC10P5X0300M	20-300	172,84
32	1"	FC32P5X0600M	FC10P5X0600M	25-600	172,84

FLOTADOR PP ROJO CON IMÁN INTERIOR incorporado para contacto exterior (suministrado aparte)

16	3/8"	FC16P5M0005M	FC38P5M0005M	0,025-0,5	140,62
16	3/8"	FC16P5M0275M	FC38P5M0275M	0,25-2,75	140,62
16	3/8"	FC16P5M0009M	FC38P5M0009M	0,5-9	140,62
16	3/8"	FC16P5M0021M	FC38P5M0021M	1-21	140,62
20	1/2"	FC20P5M0002M	FC12P5M0002M	0,1-2	145,01
20	1/2"	FC20P5M0055M	FC12P5M0055M	0,25-5,5	145,01
20	1/2"	FC20P5M0125M	FC12P5M0125M	0,5-12,5	145,01
20	1/2"	FC20P5M0255M	FC12P5M0255M	2-25,5	145,01
20	1/2"	FC20P5M0475M	FC12P5M0475M	2,5-47,5	145,01
25	3/4"	FC25P5M0010M	FC34P5M0010M	1-10	152,34
25	3/4"	FC25P5M0019M	FC34P5M0019M	1-19	152,34
25	3/4"	FC25P5M0045M	FC34P5M0045M	2-45	152,34
25	3/4"	FC25P5M0130M	FC34P5M0130M	4-130	152,34
32	1"	FC32P5M0015M	FC10P5M0015M	1-15	172,84
32	1"	FC32P5M0040M	FC10P5M0040M	2-40	172,84
32	1"	FC32P5M0110M	FC10P5M0110M	5-110	172,84
32	1"	FC32P5M0260M	FC10P5M0260M	10-260	172,84

Flujómetro corto para **Hidróxido de sodio (NaOH) 50%**.

Densidad: 1,53 kg/l - 20°C. Cuerpo: POLYSULFON. Juntas: EPDM.



FCIV / FCFV

encolar. rosca.

FLOTADOR PP ROJO

Diámetro		Ref.		Escala l/h	€
Encolar	Roscar	Encolar	Roscar		
16	3/8"	FC16T2M0014	FC38T2M0014	1,4-14	86,42
16	3/8"	FC16T2M0018	FC38T2M0018	2-18	86,42
16	3/8"	FC16T2M0045	FC38T2M0045	5-45	86,42
16	3/8"	FC16T2M0090	FC38T2M0090	10-90	86,42
16	3/8"	FC16T2M0140	FC38T2M0140	14-140	86,43
20	1/2"	FC20T2M0023	FC12T2M0023	2-23	90,82
20	1/2"	FC20T2M0045	FC12T2M0045	5-45	90,82
20	1/2"	FC20T2M0090	FC12T2M0090	10-90	90,82
20	1/2"	FC20T2M0140	FC12T2M0140	14-140	90,82
20	1/2"	FC20T2M0185	FC12T2M0185	19-185	90,82
20	1/2"	FC20T2M0300	FC12T2M0300	30-300	90,82
25	3/4"	FC25T2M0075	FC34T2M0075	7,5-75	95,20
25	3/4"	FC25T2M0140	FC34T2M0140	14-140	95,20
25	3/4"	FC25T2M0185	FC34T2M0185	19-185	95,20
25	3/4"	FC25T2M0325	FC34T2M0325	30-325	95,20
25	3/4"	FC25T2M0600	FC34T2M0600	45-600	95,20
32	1"	FC32T2M0185	FC10T2M0185	19-185	111,33
32	1"	FC32T2M0280	FC10T2M0280	28-280	111,33
32	1"	FC32T2M0550	FC10T2M0550	55-500	111,33
32	1"	FC32T2M0900	FC10T2M0900	90-900	111,33

FLOTADOR PP ROJO CON IMÁN INTERIOR

incorporado para contacto exterior (suministrado aparte)

16	3/8"	FC16T2M0014M	FC38T2M0014M	1,4-14	130,37
16	3/8"	FC16T2M0018M	FC38T2M0018M	2-18	130,37
16	3/8"	FC16T2M0045M	FC38T2M0045M	5-45	130,37
16	3/8"	FC16T2M0090M	FC38T2M0090M	10-90	130,37
16	3/8"	FC16T2M0140M	FC38T2M0140M	14-140	130,37
20	1/2"	FC20T2M0023M	FC12T2M0023M	2-23	133,29
20	1/2"	FC20T2M0045M	FC12T2M0045M	5-45	133,29
20	1/2"	FC20T2M0090M	FC12T2M0090M	10-90	133,29
20	1/2"	FC20T2M0140M	FC12T2M0140M	14-140	133,29
20	1/2"	FC20T2M0185M	FC12T2M0185M	19-185	133,29
20	1/2"	FC20T2M0300M	FC12T2M0300M	30-300	133,29
25	3/4"	FC25T2M0075M	FC34T2M0075M	7,5-75	139,16
25	3/4"	FC25T2M0140M	FC34T2M0140M	14-140	139,16
25	3/4"	FC25T2M0185M	FC34T2M0185M	19-185	139,16
25	3/4"	FC25T2M0325M	FC34T2M0325M	30-325	139,16
25	3/4"	FC25T2M0600M	FC34T2M0600M	45-600	139,16
32	1"	FC32T2M0185M	FC10T2M0185M	19-185	162,59
32	1"	FC32T2M0280M	FC10T2M0280M	28-280	162,59
32	1"	FC32T2M0550M	FC10T2M0550M	55-500	162,59
32	1"	FC32T2M0900M	FC10T2M0900M	90-900	162,59

Flujómetro corto para **Ácido clorhídrico (HCl) 30-33%**.

Densidad: 1,16 kg/l - 20°C. Cuerpo: **PVC Transparente**. Juntas: **EPDM**.



FCIV / FCFV

encolar. roscar.

FLOTADOR PP ROJO

Diámetro		Ref.		Escala l/h	€
Encolar	Roscar	Encolar	Roscar		
16	3/8"	FC16P2M0014	FC38P2M0014	1,4-14	98,14
16	3/8"	FC16P2M0018	FC38P2M0018	2-18	98,14
16	3/8"	FC16P2M0045	FC38P2M0045	5-45	98,14
16	3/8"	FC16P2M0090	FC38P2M0090	10-90	98,14
16	3/8"	FC16P2M0140	FC38P2M0140	14-140	98,14
20	1/2"	FC20P2M0023	FC12P2M0023	2-23	103,99
20	1/2"	FC20P2M0045	FC12P2M0045	5-45	103,99
20	1/2"	FC20P2M0090	FC12P2M0090	10-90	103,99
20	1/2"	FC20P2M0140	FC12P2M0140	14-140	103,99
20	1/2"	FC20P2M0185	FC12P2M0185	19-185	103,99
20	1/2"	FC20P2M0300	FC12P2M0300	30-300	103,99
25	3/4"	FC25P2M0075	FC34P2M0075	7,5-75	111,33
25	3/4"	FC25P2M0140	FC34P2M0140	14-140	111,33
25	3/4"	FC25P2M0185	FC34P2M0185	19-185	111,33
25	3/4"	FC25P2M0325	FC34P2M0325	30-325	111,33
25	3/4"	FC25P2M0600	FC34P2M0600	45-600	111,33
32	1"	FC32P2M0185	FC10P2M0185	19-185	130,37
32	1"	FC32P2M0280	FC10P2M0280	28-280	130,37
32	1"	FC32P2M0550	FC10P2M0550	55-500	130,37
32	1"	FC32P2M0900	FC10P2M0900	90-900	130,37

FLOTADOR PP ROJO CON IMÁN INTERIOR

incorporado para contacto exterior (suministrado aparte)

16	3/8"	FC16P2M0014M	FC38P2M0014M	1,4-14	143,56
16	3/8"	FC16P2M0018M	FC38P2M0018M	2-18	143,56
16	3/8"	FC16P2M0045M	FC38P2M0045M	5-45	143,56
16	3/8"	FC16P2M0090M	FC38P2M0090M	10-90	143,56
16	3/8"	FC16P2M0140M	FC38P2M0140M	14-140	143,56
20	1/2"	FC20P2M0023M	FC12P2M0023M	2-23	147,94
20	1/2"	FC20P2M0045M	FC12P2M0045M	5-45	147,94
20	1/2"	FC20P2M0090M	FC12P2M0090M	10-90	147,94
20	1/2"	FC20P2M0140M	FC12P2M0140M	14-140	147,94
20	1/2"	FC20P2M0185M	FC12P2M0185M	19-185	147,94
20	1/2"	FC20P2M0300M	FC12P2M0300M	30-300	147,94
25	3/4"	FC25P2M0075M	FC34P2M0075M	7,5-75	155,26
25	3/4"	FC25P2M0140M	FC34P2M0140M	14-140	155,26
25	3/4"	FC25P2M0185M	FC34P2M0185M	19-185	155,26
25	3/4"	FC25P2M0325M	FC34P2M0325M	30-325	155,26
25	3/4"	FC25P2M0600M	FC34P2M0600M	45-600	155,26
32	1"	FC32P2M0185M	FC10P2M0185M	19-185	181,66
32	1"	FC32P2M0280M	FC10P2M0280M	28-280	181,66
32	1"	FC32P2M0550M	FC10P2M0550M	55-500	181,66
32	1"	FC32P2M0900M	FC10P2M0900M	90-900	181,66

Flujómetro corto para **Ácido clorhídrico (HCl) 30-33%**.

Densidad: 1,16 kg/l - 20°C. Cuerpo: **POLYSULFON**. Juntas: **EPDM**.



FCIV / FCFV

encolar. roscar.

FLOTADOR PP ROJO

Diámetro		Ref. Encolar	Ref. Roscar	Escala Nm ³ /h	€
Encolar	Roscar				
16	3/8"	FC16D0M0025	FC38D0M0025	0,025-0,25	93,77
16	3/8"	FC16D0M0004	FC38D0M0004	0,04-0,4	93,77
16	3/8"	FC16D0M0001	FC38D0M0001	0,1-1	93,77
16	3/8"	FC16D0M0002	FC38D0M0002	0,2-2	93,77
20	1/2"	FC20D0M0045	FC12D0M0045	0,045-0,45	96,68
20	1/2"	FC20D0M0009	FC12D0M0009	0,09-0,9	96,68
20	1/2"	FC20D0M0015	FC12D0M0015	0,15-1,5	96,68
20	1/2"	FC20D0M0025	FC12D0M0025	0,25-2,5	96,68
20	1/2"	FC20D0M0038	FC12D0M0038	0,38-3,8	96,68
20	1/2"	FC20D0M0048	FC12D0M0048	0,4-4,8	96,68
25	3/4"	FC25D0M0012	FC34D0M0012	0,12-1,2	102,55
25	3/4"	FC25D0M0025	FC34D0M0025	0,3-2,5	102,55
25	3/4"	FC25D0M0045	FC34D0M0045	0,45-4,5	102,55
25	3/4"	FC25D0M0065	FC34D0M0065	0,6-6,5	102,55
25	3/4"	FC25D0M0011	FC34D0M0011	1,1-11	102,55
32	1"	FC32D0M0004	FC10D0M0004	0,6-4	112,77
32	1"	FC32D0M0007	FC10D0M0007	0,7-7	112,77
32	1"	FC32D0M0011	FC10D0M0011	1,1-11	112,77
32	1"	FC32D0M0014	FC10D0M0014	2-14	112,77

FLOTADOR PP ROJO CON IMÁN INTERIOR

incorporado para contacto exterior (suministrado aparte)

16	3/8"	FC16D0M0025M	FC38D0M0025M	0,025-0,25	137,70
16	3/8"	FC16D0M0004M	FC38D0M0004M	0,04-0,4	137,70
16	3/8"	FC16D0M0001M	FC38D0M0001M	0,1-1	137,70
16	3/8"	FC16D0M0002M	FC38D0M0002M	0,2-2	137,70
20	1/2"	FC20D0M0045M	FC12D0M0045M	0,045-0,45	140,62
20	1/2"	FC20D0M0009M	FC12D0M0009M	0,09-0,9	140,62
20	1/2"	FC20D0M0015M	FC12D0M0015M	0,15-1,5	140,62
20	1/2"	FC20D0M0025M	FC12D0M0025M	0,25-2,5	140,62
20	1/2"	FC20D0M0038M	FC12D0M0038M	0,38-3,8	140,62
20	1/2"	FC20D0M0048M	FC12D0M0048M	0,4-4,8	140,62
25	3/4"	FC25D0M0012M	FC34D0M0012M	0,12-1,2	146,48
25	3/4"	FC25D0M0025M	FC34D0M0025M	0,3-2,5	146,48
25	3/4"	FC25D0M0045M	FC34D0M0045M	0,45-4,5	146,48
25	3/4"	FC25D0M0065M	FC34D0M0065M	0,6-6,5	146,48
25	3/4"	FC25D0M0011M	FC34D0M0011M	1,1-11	146,48
32	1"	FC32D0M0004M	FC10D0M0004M	0,6-4	164,05
32	1"	FC32D0M0007M	FC10D0M0007M	0,7-7	164,05
32	1"	FC32D0M0011M	FC10D0M0011M	1,1-11	164,05
32	1"	FC32D0M0014M	FC10D0M0014M	2-14	164,05

Flujómetro corto para Aire.

Densidad: 1,013 bar abs. - 20°C. Cuerpo: TROGAMID. Juntas: EPDM.



S1

Ref.	Descripción	€
MSMIN02	Contacto de MÍNIMA para diámetros 16-20-25 *	99,62
MSMAX02	Contacto de MÁXIMA para diámetros 16-20-25 *	99,62
MSMIN01	Contacto de MÍNIMA para diámetros 32 *	99,62
MSMAX01	Contacto de MÁXIMA para diámetros 32 *	99,62
	Escala especial	Consultar
	Doble escala	Consultar

Contactos exteriores.

Sólo utilizables con flujómetros que incorporen imán exterior
 * Para usar con flotador con imán incorporado



I

d	Ref.	Descripción	€
16	QBIC016	Manguito C-PVC	7,17
20	QBIC020	Manguito C-PVC	7,12
25	QBIC025	Manguito C-PVC	8,33
32	QBIC032	Manguito C-PVC	10,83
20	QBIGM020	Manguito PP-H	3,03
25	QBIGM025	Manguito PP-H	3,08
32	QBIGM032	Manguito PP-H	3,28
20	QBIGF020	Manguito PVDF	9,06
25	QBIGF025	Manguito PVDF	11,72
32	QBIGF032	Manguito PVDF	13,06

Manguitos.

Para cada flujómetro es necesario pedir 2 manguitos

16	EFC034	Tuerca C-PVC	5,72
20	EFC100	Tuerca C-PVC	6,37
25	EFC114	Tuerca C-PVC	7,38
32	EFC112	Tuerca C-PVC	10,70
20	EFGM100	Tuerca PP-H	5,79
25	EFGM114	Tuerca PP-H	6,00
32	EFGM112	Tuerca PP-H	6,96
20	EFGF100	Tuerca PVDF	14,93
25	EFGF114	Tuerca PVDF	20,38
32	EFGF112	Tuerca PVDF	25,27

Tuercas.

Para cada flujómetro es necesario pedir 2 tuercas

16	OR3062F	Junta FKM	3,46
20	OR4081F	Junta FKM	10,61
25	OR4112F	Junta FKM	2,00
32	OR4131F	Junta FKM	5,65

Juntas.

Para cada flujómetro es necesario pedir 2 juntas

Bajo pedido disponemos también de conexiones rosca hembra de 3/8" a 1" en acero inoxidable AISI 316 y en acero al carbono.



FSIV / FSFV

encolar. roscar.

FLOTADOR INOX AISI 316

Diámetro		Ref. Encolar	Ref. Roscar	Escala l/h	€
Encolar	Roscar				
25	3/4"	FS25D1X0250	FS34D1X0250	25-250	125,97
25	3/4"	FS25D1X0400	FS34D1X0400	40-400	125,97
25	3/4"	FS25D1X0640	FS34D1X0640	60-640	125,97
25	3/4"	FS25D1X1000	FS34D1X1000	100-1000	125,97
32	1"	FS32D1X0400	FS10D1X0400	40-400	143,56
32	1"	FS32D1X0640	FS10D1X0640	60-640	143,56
32	1"	FS32D1X1000	FS10D1X1000	100-1000	143,56
32	1"	FS32D1X1600	FS10D1X1600	150-1600	143,56
40	1 1/4"	FS40D1X1600	FS14D1X1600	150-1600	193,36
40	1 1/4"	FS40D1X2500	FS14D1X2500	200-2500	193,36
40	1 1/4"	FS40D1X4000	FS14D1X4000	400-4000	193,36
50	1 1/2"	FS50D1X2500	FS12D1X2500	200-2500	228,50
50	1 1/2"	FS50D1X4000	FS12D1X4000	400-4000	228,50
50	1 1/2"	FS50D1X5000	FS12D1X5000	500-5000	228,50
63	2"	FS63D1X4000	FS20D1X4000	400-4000	306,15
63	2"	FS63D1X6000	FS20D1X6000	600-6000	306,15
63	2"	FS63D1X0010	FS20D1X0010	1000-10000	306,15
75		FS75D1X0015		1500-15000	531,75
75		FS75D1X0020		2000-20000	531,75
75		FS75D1X0050		10000-50000	531,75

FLOTADOR PP ROJO

25	3/4"	FS25D1M0150	FS34D1M0150	15-150	125,97
25	3/4"	FS25D1M0250	FS34D1M0250	25-250	125,97
25	3/4"	FS25D1M0450	FS34D1M0450	45-450	125,97
25	3/4"	FS25D1M0700	FS34D1M0700	70-700	125,97
32	1"	FS32D1M0250	FS10D1M0250	25-250	143,56
32	1"	FS32D1M0400	FS10D1M0400	40-400	143,56
32	1"	FS32D1M0650	FS10D1M0650	65-650	143,56
32	1"	FS32D1M1000	FS10D1M1000	100-1000	143,56
40	1 1/4"	FS40D1M1000	FS14D1M1000	100-1000	193,36
40	1 1/4"	FS40D1M1600	FS14D1M1600	160-1600	193,36
40	1 1/4"	FS40D1M2500	FS14D1M2500	200-2500	193,36
50	1 1/2"	FS50D1M1600	FS12D1M1600	150-1600	228,50
50	1 1/2"	FS50D1M2200	FS12D1M2200	200-2200	228,50
50	1 1/2"	FS50D1M2500	FS12D1M2500	250-2500	228,50
63	2"	FS63D1M2500	FS20D1M2500	250-2500	306,15
63	2"	FS63D1M3500	FS20D1M3500	350-3500	306,15
63	2"	FS63D1M5000	FS20D1M5000	500-5000	306,15
75		FS75D1M8000		1000-8000	531,75
75		FS75D1M0010		1000-10000	531,75
75		FS75D1M0025		5000-25000	531,75

Flujómetro largo para H₂O.

Densidad: 1 kg/l - 20°C. Cuerpo: TROGAMID. Juntas: EPDM.



FSIV / FSFV

encolar. roscar.

FLOTADOR INOX AISI 316 CON IMÁN INTERIOR incorporado para contacto exterior (suministrado aparte)

S1

Diámetro		Ref. Encolar	Ref. Roscar	Escala l/h	€
Encolar	Roscar				
25	¾"	FS25D1X0250M	FS34D1X0250M	25-250	180,19
25	¾"	FS25D1X0400M	FS34D1X0400M	40-400	180,19
25	¾"	FS25D1X0640M	FS34D1X0640M	60-640	180,19
25	¾"	FS25D1X1000M	FS34D1X1000M	100-1000	180,19
32	1"	FS32D1X0400M	FS10D1X0400M	40-400	194,83
32	1"	FS32D1X0640M	FS10D1X0640M	60-640	194,83
32	1"	FS32D1X1000M	FS10D1X1000M	100-1000	194,83
32	1"	FS32D1X1600M	FS10D1X1600M	150-1600	194,83
40	1¼"	FS40D1X1600M	FS14D1X1600M	150-1600	249,03
40	1¼"	FS40D1X2500M	FS14D1X2500M	200-2500	249,03
40	1¼"	FS40D1X4000M	FS14D1X4000M	400-4000	249,03
50	1½"	FS50D1X2500M	FS12D1X2500M	200-2500	288,55
50	1½"	FS50D1X4000M	FS12D1X4000M	400-4000	288,55
50	1½"	FS50D1X5000M	FS12D1X5000M	500-5000	288,55
63	2"	FS63D1X4000M	FS20D1X4000M	400-4000	374,99
63	2"	FS63D1X6000M	FS20D1X6000M	600-6000	374,99
63	2"	FS63D1X0010M	FS20D1X0010M	1000-10000	374,99
75		FS75D1X0015M		1500-15000	678,21
75		FS75D1X0020M		2000-20000	678,21
75		FS75D1X0050M		10000-50000	678,21

FLOTADOR PP ROJO CON IMÁN INTERIOR incorporado para contacto exterior (suministrado aparte)

25	¾"	FS25D1M0150M	FS34D1M0150M	15-150	180,19
25	¾"	FS25D1M0250M	FS34D1M0250M	25-250	180,19
25	¾"	FS25D1M0450M	FS34D1M0450M	45-450	180,19
25	¾"	FS25D1M0700M	FS34D1M0700M	70-700	180,19
32	1"	FS32D1M0250M	FS10D1M0250M	25-250	194,83
32	1"	FS32D1M0400M	FS10D1M0400M	40-400	194,83
32	1"	FS32D1M0650M	FS10D1M0650M	65-650	194,83
32	1"	FS32D1M1000M	FS10D1M1000M	100-1000	194,83
40	1¼"	FS40D1M1000M	FS14D1M1000M	100-1000	249,03
40	1¼"	FS40D1M1600M	FS14D1M1600M	160-1600	249,03
40	1¼"	FS40D1M2500M	FS14D1M2500M	200-2500	249,03
50	1½"	FS50D1M1600M	FS12D1M1600M	150-1600	288,55
50	1½"	FS50D1M2200M	FS12D1M2200M	200-2200	288,55
50	1½"	FS50D1M2500M	FS12D1M2500M	250-2500	288,55
63	2"	FS63D1M2500M	FS20D1M2500M	250-2500	374,99
63	2"	FS63D1M3500M	FS20D1M3500M	350-3500	374,99
63	2"	FS63D1M5000M	FS20D1M5000M	500-5000	374,99
75		FS75D1M8000M		1000-8000	678,21
75		FS75D1M0010M		1000-10000	678,21
75		FS75D1M0025M		5000-25000	678,21

Flujómetro largo para H₂O.

Densidad: 1 kg/l - 20°C. Cuerpo: TROGAMID. Juntas: EPDM.



FSIV / FSFV

encolar. roscar.

FLOTADOR INOX AISI 316

Diámetro		Ref. Encolar	Ref. Roscar	Escala l/h	€
Encolar	Roscar				
25	3/4"	FS25T1X0250	FS34T1X0250	25-250	120,11
25	3/4"	FS25T1X0400	FS34T1X0400	40-400	120,11
25	3/4"	FS25T1X0640	FS34T1X0640	60-640	120,11
25	3/4"	FS25T1X1000	FS34T1X1000	100-1000	120,11
32	1"	FS32T1X0400	FS10T1X0400	40-400	136,23
32	1"	FS32T1X0640	FS10T1X0640	60-640	136,23
32	1"	FS32T1X1000	FS10T1X1000	100-1000	136,23
32	1"	FS32T1X1600	FS10T1X1600	150-1600	136,23
40	1 1/4"	FS40T1X1600	FS14T1X1600	150-1600	184,55
40	1 1/4"	FS40T1X2500	FS14T1X2500	200-2500	184,55
40	1 1/4"	FS40T1X4000	FS14T1X4000	400-4000	184,55
50	1 1/2"	FS50T1X2500	FS12T1X2500	200-2500	216,80
50	1 1/2"	FS50T1X4000	FS12T1X4000	400-4000	216,80
50	1 1/2"	FS50T1X5000	FS12T1X5000	500-5000	216,80
63	2"	FS63T1X4000	FS20T1X4000	400-4000	290,04
63	2"	FS63T1X6000	FS20T1X6000	600-6000	290,04
63	2"	FS63T1X0010	FS20T1X0010	1000-10000	290,04
75		FS75T1X0015		1500-15000	505,35
75		FS75T1X0020		2000-20000	505,35
75		FS75T1X0050		10000-50000	505,35

FLOTADOR PP ROJO

25	3/4"	FS25T1M0150	FS34T1M0150	15-150	120,11
25	3/4"	FS25T1M0250	FS34T1M0250	25-250	120,11
25	3/4"	FS25T1M0450	FS34T1M0450	45-450	120,11
25	3/4"	FS25T1M0700	FS34T1M0700	70-700	120,11
32	1"	FS32T1M0250	FS10T1M0250	25-250	136,23
32	1"	FS32T1M0400	FS10T1M0400	40-400	136,23
32	1"	FS32T1M0650	FS10T1M0650	65-650	136,23
32	1"	FS32T1M1000	FS10T1M1000	100-1000	136,23
40	1 1/4"	FS40T1M1000	FS14T1M1000	100-1000	184,55
40	1 1/4"	FS40T1M1600	FS14T1M1600	160-1600	184,55
40	1 1/4"	FS40T1M2500	FS14T1M2500	200-2500	184,55
50	1 1/2"	FS50T1M1600	FS12T1M1600	150-1600	216,80
50	1 1/2"	FS50T1M2200	FS12T1M2200	200-2200	216,80
50	1 1/2"	FS50T1M2500	FS12T1M2500	250-2500	216,80
63	2"	FS63T1M2500	FS20T1M2500	250-2500	290,04
63	2"	FS63T1M3500	FS20T1M3500	350-3500	290,04
63	2"	FS63T1M5000	FS20T1M5000	500-5000	290,04
75		FS75T1M8000		1000-8000	505,35
75		FS75T1M0010		1000-10000	505,35
75		FS75T1M0025		5000-25000	505,35

Flujómetro largo para H₂O.

Densidad: 1 kg/l - 20°C. Cuerpo: PVC Transparente. Juntas: EPDM.



FSIV / FSFV

encolar. roscar.

FLOTADOR INOX AISI 316 CON IMÁN INTERIOR incorporado para contacto exterior (suministrado aparte)

S1

Diámetro		Ref. Encolar	Ref. Roscar	Escala l/h	€
Encolar	Roscar				
25	¾"	FS25T1X0250M	FS34T1X0250M	25-250	174,31
25	¾"	FS25T1X0400M	FS34T1X0400M	40-400	174,31
25	¾"	FS25T1X0640M	FS34T1X0640M	60-640	174,31
25	¾"	FS25T1X1000M	FS34T1X1000M	100-1000	174,31
32	1"	FS32T1X0400M	FS10T1X0400M	40-400	187,50
32	1"	FS32T1X0640M	FS10T1X0640M	60-640	187,50
32	1"	FS32T1X1000M	FS10T1X1000M	100-1000	187,50
32	1"	FS32T1X1600M	FS10T1X1600M	150-1600	187,50
40	1¼"	FS40T1X1600M	FS14T1X1600M	150-1600	240,24
40	1¼"	FS40T1X2500M	FS14T1X2500M	200-2500	240,24
40	1¼"	FS40T1X4000M	FS14T1X4000M	400-4000	240,24
50	1½"	FS50T1X2500M	FS12T1X2500M	200-2500	276,87
50	1½"	FS50T1X4000M	FS12T1X4000M	400-4000	276,87
50	1½"	FS50T1X5000M	FS12T1X5000M	500-5000	276,87
63	2"	FS63T1X4000M	FS20T1X4000M	400-4000	358,89
63	2"	FS63T1X6000M	FS20T1X6000M	600-6000	358,89
63	2"	FS63T1X0010MF	FS20T1X0010M	1000-10000	358,89
75		S75T1X0015MF		1500-15000	651,86
75		S75T1X0020MF		2000-20000	651,86
75		S75T1X0050MF		10000-50000	651,86

FLOTADOR PP ROJO CON IMÁN INTERIOR incorporado para contacto exterior (suministrado aparte)

25	¾"	FS25T1M0150M	FS34T1M0150M	15-150	174,31
25	¾"	FS25T1M0250M	FS34T1M0250M	25-250	174,31
25	¾"	FS25T1M0450M	FS34T1M0450M	45-450	174,31
25	¾"	FS25T1M0700M	FS34T1M0700M	70-700	174,31
32	1"	FS32T1M0250M	FS10T1M0250M	25-250	187,50
32	1"	FS32T1M0400M	FS10T1M0400M	40-400	187,50
32	1"	FS32T1M0650M	FS10T1M0650M	65-650	187,50
32	1"	FS32T1M1000M	FS10T1M1000M	100-1000	187,50
40	1¼"	FS40T1M1000M	FS14T1M1000M	100-1000	240,24
40	1¼"	FS40T1M1600M	FS14T1M1600M	160-1600	240,24
40	1¼"	FS40T1M2500M	FS14T1M2500M	200-2500	240,24
50	1½"	FS50T1M1600M	FS12T1M1600M	150-1600	276,87
50	1½"	FS50T1M2200M	FS12T1M2200M	200-2200	276,87
50	1½"	FS50T1M2500M	FS12T1M2500M	250-2500	276,87
63	2"	FS63T1M2500M	FS20T1M2500M	250-2500	358,89
63	2"	FS63T1M3500M	FS20T1M3500M	350-3500	358,89
63	2"	FS63T1M5000M	FS20T1M5000M	500-5000	358,89
75		FS75T1M8000M		1000-8000	651,86
75		FS75T1M0010M		1000-10000	651,86
75		FS75T1M0025M		5000-25000	651,86

Flujómetro largo para H₂O.

Densidad: 1 kg/l - 20°C. Cuerpo: PVC Transparente. Juntas: EPDM.



FSIV / FSFV

encolar. roscar.

FLOTADOR INOX AISI 316

Diámetro		Ref.		Escala l/h	€
Encolar	Roscar	Encolar	Roscar		
25	3/4"	FS25P1X0250	FS34P1X0250	25-250	156,73
25	3/4"	FS25P1X0400	FS34P1X0400	40-400	156,73
25	3/4"	FS25P1X0640	FS34P1X0640	60-640	156,73
25	3/4"	FS25P1X1000	FS34P1X1000	100-1000	156,73
32	1"	FS32P1X0400	FS10P1X0400	40-400	180,19
32	1"	FS32P1X0640	FS10P1X0640	60-640	180,19
32	1"	FS32P1X1000	FS10P1X1000	100-1000	180,19
32	1"	FS32P1X1600	FS10P1X1600	150-1600	180,19
40	1 1/4"	FS40P1X1600	FS14P1X1600	150-1600	232,93
40	1 1/4"	FS40P1X2500	FS14P1X2500	200-2500	232,93
40	1 1/4"	FS40P1X4000	FS14P1X4000	400-4000	232,93
50	1 1/2"	FS50P1X2500	FS12P1X2500	200-2500	285,64
50	1 1/2"	FS50P1X4000	FS12P1X4000	400-4000	285,64
50	1 1/2"	FS50P1X5000	FS12P1X5000	500-5000	285,64
63	2"	FS63P1X4000	FS20P1X4000	400-4000	382,31
63	2"	FS63P1X6000	FS20P1X6000	600-6000	382,31
63	2"	FS63P1X0010	FS20P1X0010	1000-10000	382,31
75		FS75P1X0015		1500-15000	665,03
75		FS75P1X0020		2000-20000	665,03
75		FS75P1X0050		10000-50000	665,03

FLOTADOR PP ROJO

25	3/4"	FS25P1M0150	FS34P1M0150	15-150	156,73
25	3/4"	FS25P1M0250	FS34P1M0250	25-250	156,73
25	3/4"	FS25P1M0450	FS34P1M0450	45-450	156,73
25	3/4"	FS25P1M0700	FS34P1M0700	70-700	156,73
32	1"	FS32P1M0250	FS10P1M0250	25-250	180,19
32	1"	FS32P1M0400	FS10P1M0400	40-400	180,19
32	1"	FS32P1M0650	FS10P1M0650	65-650	180,19
32	1"	FS32P1M1000	FS10P1M1000	100-1000	180,19
40	1 1/4"	FS40P1M1000	FS14P1M1000	100-1000	232,93
40	1 1/4"	FS40P1M1600	FS14P1M1600	160-1600	232,93
40	1 1/4"	FS40P1M2500	FS14P1M2500	200-2500	232,93
50	1 1/2"	FS50P1M1600	FS12P1M1600	150-1600	285,64
50	1 1/2"	FS50P1M2200	FS12P1M2200	200-2200	285,64
50	1 1/2"	FS50P1M2500	FS12P1M2500	250-2500	285,64
63	2"	FS63P1M2500	FS20P1M2500	250-2500	382,31
63	2"	FS63P1M3500	FS20P1M3500	350-3500	382,31
63	2"	FS63P1M5000	FS20P1M5000	500-5000	382,31
75		FS75P1M8000		1000-8000	665,03
75		FS75P1M0010		1000-10000	665,03
75		FS75P1M0025		5000-25000	665,03

Flujómetro largo para H₂O.

Densidad: 1 kg/l - 20°C. Cuerpo: POLYSULFON. Juntas: EPDM.



FSIV / FSFV

encolar. roscar.

FLOTADOR INOX AISI 316 CON IMÁN INTERIOR incorporado para contacto exterior (suministrado aparte)

S1

Diámetro		Ref. Encolar	Ref. Roscar	Escala l/h	€
Encolar	Roscar				
25	¾"	FS25P1X0250M	FS34P1X0250M	25-250	210,93
25	¾"	FS25P1X0400M	FS34P1X0400M	40-400	210,93
25	¾"	FS25P1X0640M	FS34P1X0640M	60-640	210,93
25	¾"	FS25P1X1000M	FS34P1X1000M	100-1000	210,93
32	1"	FS32P1X0400M	FS10P1X0400M	40-400	231,43
32	1"	FS32P1X0640M	FS10P1X0640M	60-640	231,43
32	1"	FS32P1X1000M	FS10P1X1000M	100-1000	231,43
32	1"	FS32P1X1600M	FS10P1X1600M	150-1600	231,43
40	1¼"	FS40P1X1600M	FS14P1X1600M	150-1600	288,55
40	1¼"	FS40P1X2500M	FS14P1X2500M	200-2500	288,55
40	1¼"	FS40P1X4000M	FS14P1X4000M	400-4000	288,55
50	1½"	FS50P1X2500M	FS12P1X2500M	200-2500	345,70
50	1½"	FS50P1X4000M	FS12P1X4000M	400-4000	345,70
50	1½"	FS50P1X5000M	FS12P1X5000M	500-5000	345,70
63	2"	FS63P1X4000M	FS20P1X4000M	400-4000	451,17
63	2"	FS63P1X6000M	FS20P1X6000M	600-6000	451,17
63	2"	FS63P1X0010M	FS20P1X0010M	1000-10000	451,17
75		FS75P1X0015M		1500-15000	811,52
75		FS75P1X0020M		2000-20000	811,52
75		FS75P1X0050M		10000-50000	811,52

FLOTADOR PP ROJO CON IMÁN INTERIOR incorporado para contacto exterior (suministrado aparte)

25	¾"	FS25P1M0150M	FS34P1M0150M	15-150	210,93
25	¾"	FS25P1M0250M	FS34P1M0250M	25-250	210,93
25	¾"	FS25P1M0450M	FS34P1M0450M	45-450	210,93
25	¾"	FS25P1M0700M	FS34P1M0700M	70-700	210,93
32	1"	FS32P1M0250M	FS10P1M0250M	25-250	231,43
32	1"	FS32P1M0400M	FS10P1M0400M	40-400	231,43
32	1"	FS32P1M0650M	FS10P1M0650M	65-650	231,43
32	1"	FS32P1M1000M	FS10P1M1000M	100-1000	231,43
40	1¼"	FS40P1M1000M	FS14P1M1000M	100-1000	288,55
40	1¼"	FS40P1M1600M	FS14P1M1600M	160-1600	288,55
40	1¼"	FS40P1M2500M	FS14P1M2500M	200-2500	288,55
50	1½"	FS50P1M1600M	FS12P1M1600M	150-1600	345,70
50	1½"	FS50P1M2200M	FS12P1M2200M	200-2200	345,70
50	1½"	FS50P1M2500M	FS12P1M2500M	250-2500	345,70
63	2"	FS63P1M2500M	FS20P1M2500M	250-2500	451,17
63	2"	FS63P1M3500M	FS20P1M3500M	350-3500	451,17
63	2"	FS63P1M5000M	FS20P1M5000M	500-5000	451,17
75		FS75P1M8000M		1000-8000	811,52
75		FS75P1M0010M		1000-10000	811,52
75		FS75P1M0025M		5000-25000	811,52

Flujómetro largo para **H₂O**.

Densidad: 1 kg/l - 20°C. Cuerpo: **POLYSULFON**. Juntas: **EPDM**.



FSIV / FSFV

encolar. roscar.

FLOTADOR INOX AISI 316

Diámetro		Ref. Encolar	Ref. Roscar	Escala l/h	€
Encolar	Roscar				
25	3/4"	FS25T3X0125	FS34T3X0125	6-125	136,47
25	3/4"	FS25T3X0240	FS34T3X0240	10-240	136,47
25	3/4"	FS25T3X0425	FS34T3X0425	25-425	136,47
25	3/4"	FS25T3X0725	FS34T3X0725	35-725	136,47
32	1"	FS32T3X0240	FS10T3X0240	10-240	154,80
32	1"	FS32T3X0420	FS10T3X0420	20-420	154,80
32	1"	FS32T3X0700	FS10T3X0700	25-700	154,80
32	1"	FS32T3X1200	FS10T3X1200	50-1200	154,80
40	1 1/4"	FS40T3X1150	FS14T3X1150	50-1150	209,70
40	1 1/4"	FS40T3X1900	FS14T3X1900	100-1900	209,70
40	1 1/4"	FS40T3X3200	FS14T3X3200	200-3200	209,70
50	1 1/2"	FS50T3X1700	FS12T3X1700	100-1700	246,35
50	1 1/2"	FS50T3X3000	FS12T3X3000	200-3000	246,35
50	1 1/2"	FS50T3X3700	FS12T3X3700	200-3700	246,35
63	2"	FS63T3X3000	FS20T3X3000	100-3000	329,58
63	2"	FS63T3X4700	FS20T3X4700	250-4700	329,58
63	2"	FS63T3X8500	FS20T3X8500	500-8500	329,58
75		FS75T3X0012		1000-12000	574,24
75		FS75T3X0165		1500-16500	574,24
75		FS75T3X0043		8800-43000	574,24

FLOTADOR PP ROJO

25	3/4"	FS25T3M0054	FS34T3M0054	2,5-54	136,47
25	3/4"	FS25T3M0115	FS34T3M0115	6-115	136,47
25	3/4"	FS25T3M0235	FS34T3M0235	11-235	136,47
25	3/4"	FS25T3M0410	FS34T3M0410	28-410	136,47
32	1"	FS32T3M0125	FS10T3M0125	6-125	154,80
32	1"	FS32T3M0100	FS10T3M0100	10-100	154,80
32	1"	FS32T3M0395	FS10T3M0395	11-395	154,80
32	1"	FS32T3M0650	FS10T3M0650	25-650	154,80
40	1 1/4"	FS40T3M0600	FS14T3M0600	25-600	209,70
40	1 1/4"	FS40T3M1100	FS14T3M1100	55-1100	209,70
40	1 1/4"	FS40T3M1700	FS14T3M1700	100-1700	209,70
50	1 1/2"	FS50T3M1000	FS12T3M1000	50-1000	246,35
50	1 1/2"	FS50T3M1500	FS12T3M1500	100-1500	246,35
50	1 1/2"	FS50T3M1600	FS12T3M1600	120-1600	246,35
63	2"	FS63T3M1700	FS20T3M1700	60-1700	329,58
63	2"	FS63T3M2500	FS20T3M2500	90-2500	329,58
63	2"	FS63T3M4000	FS20T3M4000	200-4000	329,58
75		FS75T3M6000		670-6000	574,24
75		FS75T3M7500		500-7500	574,24
75		FS75T3M0022		4400-22000	574,24

Flujómetro largo para **Hidróxido de sodio (NaOH) 30%**.
 Densidad: 1,33 kg/l - 20°C. Cuerpo: **PVC Transparente**. Juntas: **EPDM**.



FSIV / FSFV

encolar. roscar.

FLOTADOR INOX AISI 316 CON IMÁN INTERIOR incorporado para contacto exterior (suministrado aparte)

S1

Diámetro		Ref. Encolar	Ref. Roscar	Escala l/h	€
Encolar	Roscar				
25	¾"	FS25T3X0125M	FS34T3X0125M	6-125	198,08
25	¾"	FS25T3X0240M	FS34T3X0240M	10-240	198,08
25	¾"	FS25T3X0425M	FS34T3X0425M	25-425	198,08
25	¾"	FS25T3X0725M	FS34T3X0725M	35-725	198,08
32	1"	FS32T3X0240M	FS10T3X0240M	10-240	213,05
32	1"	FS32T3X0420M	FS10T3X0420M	20-420	213,05
32	1"	FS32T3X0700M	FS10T3X0700M	25-700	213,05
32	1"	FS32T3X1200M	FS10T3X1200M	50-1200	213,05
40	1¼"	FS40T3X1150M	FS14T3X1150M	50-1150	272,98
40	1¼"	FS40T3X1900M	FS14T3X1900M	100-1900	272,98
40	1¼"	FS40T3X3200M	FS14T3X3200M	200-3200	272,98
50	1½"	FS50T3X1700M	FS12T3X1700M	100-1700	314,60
50	1½"	FS50T3X3000M	FS12T3X3000M	200-3000	314,60
50	1½"	FS50T3X3700M	FS12T3X3700M	200-3700	314,60
63	2"	FS63T3X3000M	FS20T3X3000M	100-3000	407,81
63	2"	FS63T3X4700M	FS20T3X4700M	250-4700	407,81
63	2"	FS63T3X8500M	FS20T3X8500M	500-8500	407,81
75		FS75T3X0012M		1000-12000	740,69
75		FS75T3X0165M		1500-16500	740,69
75		FS75T3X0043M		8800-43000	740,69

FLOTADOR PP ROJO CON IMÁN INTERIOR incorporado para contacto exterior (suministrado aparte)

25	¾"	FS25T3M0054M	FS34T3M0054M	2,5-54	198,08
25	¾"	FS25T3M0115M	FS34T3M0115M	6-115	198,08
25	¾"	FS25T3M0235M	FS34T3M0235M	11-235	198,08
25	¾"	FS25T3M0410M	FS34T3M0410M	28-410	198,08
32	1"	FS32T3M0125M	FS10T3M0125M	6-125	213,05
32	1"	FS32T3M0100M	FS10T3M0100M	10-100	213,05
32	1"	FS32T3M0395M	FS10T3M0395M	11-395	213,05
32	1"	FS32T3M0650M	FS10T3M0650M	25-650	213,05
40	1¼"	FS40T3M0600M	FS14T3M0600M	25-600	272,98
40	1¼"	FS40T3M1100M	FS14T3M1100M	55-1100	272,98
40	1¼"	FS40T3M1700M	FS14T3M1700M	100-1700	272,98
50	1½"	FS50T3M1000M	FS12T3M1000M	50-1000	314,60
50	1½"	FS50T3M1500M	FS12T3M1500M	100-1500	314,60
50	1½"	FS50T3M1600M	FS12T3M1600M	120-1600	314,60
63	2"	FS63T3M1700M	FS20T3M1700M	60-1700	407,81
63	2"	FS63T3M2500M	FS20T3M2500M	90-2500	407,81
63	2"	FS63T3M4000M	FS20T3M4000M	200-4000	407,81
75		FS75T3M6000M		670-6000	740,69
75		FS75T3M7500M		500-7500	740,69
75		FS75T3M0022M		4400-22000	740,69

Flujómetro largo para **Hidróxido de sodio (NaOH) 30%**.

Densidad: 1,33 kg/l - 20°C. Cuerpo: **PVC Transparente**. Juntas: **EPDM**.



FSIV / FSFV

encolar. roscar.

FLOTADOR INOX AISI 316

Diámetro		Ref.		Escala l/h	€
Encolar	Roscar	Encolar	Roscar		
25	3/4"	FS25P3X0125	FS34P3X0125	6-125	178,09
25	3/4"	FS25P3X0240	FS34P3X0240	10-240	178,09
25	3/4"	FS25P3X0425	FS34P3X0425	25-425	178,09
25	3/4"	FS25P3X0725	FS34P3X0725	35-725	178,09
32	1"	FS32P3X0240	FS10P3X0240	10-240	204,72
32	1"	FS32P3X0420	FS10P3X0420	20-420	204,72
32	1"	FS32P3X0700	FS10P3X0700	25-700	204,72
32	1"	FS32P3X1200	FS10P3X1200	50-1200	204,72
40	1 1/4"	FS40P3X1150	FS14P3X1150	50-1150	264,68
40	1 1/4"	FS40P3X1900	FS14P3X1900	100-1900	264,68
40	1 1/4"	FS40P3X3200	FS14P3X3200	200-3200	264,68
50	1 1/2"	FS50P3X1700	FS12P3X1700	100-1700	324,58
50	1 1/2"	FS50P3X3000	FS12P3X3000	200-3000	324,58
50	1 1/2"	FS50P3X3700	FS12P3X3700	200-3700	324,58
63	2"	FS63P3X3000	FS20P3X3000	100-3000	434,42
63	2"	FS63P3X4700	FS20P3X4700	250-4700	434,42
63	2"	FS63P3X8500	FS20P3X8500	500-8500	434,42
75		FS75P3X0012		1000-12000	755,68
75		FS75P3X0165		1500-16500	755,68
75		FS75P3X0043		8800-43000	755,68

FLOTADOR PP ROJO

25	3/4"	FS25P3M0054	FS34P3M0054	2,5-54	178,09
25	3/4"	FS25P3M0115	FS34P3M0115	6-115	178,09
25	3/4"	FS25P3M0235	FS34P3M0235	11-235	178,09
25	3/4"	FS25P3M0410	FS34P3M0410	28-410	178,09
32	1"	FS32P3M0125	FS10P3M0125	6-125	204,72
32	1"	FS32P3M0100	FS10P3M0100	10-100	204,72
32	1"	FS32P3M0395	FS10P3M0395	11-395	204,72
32	1"	FS32P3M0650	FS10P3M0650	25-650	204,72
40	1 1/4"	FS40P3M0600	FS14P3M0600	25-600	264,68
40	1 1/4"	FS40P3M1100	FS14P3M1100	55-1100	264,68
40	1 1/4"	FS40P3M1700	FS14P3M1700	100-1700	264,68
50	1 1/2"	FS50P3M1000	FS12P3M1000	50-1000	324,58
50	1 1/2"	FS50P3M1500	FS12P3M1500	100-1500	324,58
50	1 1/2"	FS50P3M1600	FS12P3M1600	120-1600	324,58
63	2"	FS63P3M1700	FS20P3M1700	60-1700	434,42
63	2"	FS63P3M2500	FS20P3M2500	90-2500	434,42
63	2"	FS63P3M4000	FS20P3M4000	200-4000	434,42
75		FS75P3M6000		670-6000	755,68
75		FS75P3M7500		500-7500	755,68
75		FS75P3M0022		4400-22000	755,68

Flujómetro largo para **Hidróxido de sodio (NaOH) 30%**.
 Densidad: 1,33 kg/l - 20°C. Cuerpo: **POLYSULFON**. Juntas: **EPDM**.



FSIV / FSFV

encolar. roscar.

FLOTADOR INOX AISI 316 CON IMÁN INTERIOR incorporado para contacto exterior (suministrado aparte)

S1

Diámetro		Ref. Encolar	Ref. Roscar	Escala l/h	€
Encolar	Roscar				
25	¾"	FS25P3X0125M	FS34P3X0125M	6-125	239,70
25	¾"	FS25P3X0240M	FS34P3X0240M	10-240	239,70
25	¾"	FS25P3X0425M	FS34P3X0425M	25-425	239,70
25	¾"	FS25P3X0725M	FS34P3X0725M	35-725	239,70
32	1"	FS32P3X0240M	FS10P3X0240M	10-240	262,98
32	1"	FS32P3X0420M	FS10P3X0420M	20-420	262,98
32	1"	FS32P3X0700M	FS10P3X0700M	25-700	262,98
32	1"	FS32P3X1200M	FS10P3X1200M	50-1200	262,98
40	1¼"	FS40P3X1150M	FS14P3X1150M	50-1150	327,89
40	1¼"	FS40P3X1900M	FS14P3X1900M	100-1900	327,89
40	1¼"	FS40P3X3200M	FS14P3X3200M	200-3200	327,89
50	1½"	FS50P3X1700M	FS12P3X1700M	100-1700	392,82
50	1½"	FS50P3X3000M	FS12P3X3000M	200-3000	392,82
50	1½"	FS50P3X3700M	FS12P3X3700M	200-3700	392,82
63	2"	FS63P3X3000M	FS20P3X3000M	100-3000	512,67
63	2"	FS63P3X4700M	FS20P3X4700M	250-4700	512,67
63	2"	FS63P3X8500M	FS20P3X8500M	500-8500	512,67
75		FS75P3X0012M		1000-12000	922,14
75		FS75P3X0165M		1500-16500	922,14
75		FS75P3X0043M		8800-43000	922,14

FLOTADOR PP ROJO CON IMÁN INTERIOR incorporado para contacto exterior (suministrado aparte)

25	¾"	FS25P3M0054M	FS34P3M0054M	2,5-54	239,70
25	¾"	FS25P3M0115M	FS34P3M0115M	6-115	239,70
25	¾"	FS25P3M0235M	FS34P3M0235M	11-235	239,70
25	¾"	FS25P3M0410M	FS34P3M0410M	28-410	239,70
32	1"	FS32P3M0125M	FS10P3M0125M	6-125	262,98
32	1"	FS32P3M0100M	FS10P3M0100M	10-100	262,98
32	1"	FS32P3M0395M	FS10P3M0395M	11-395	262,98
32	1"	FS32P3M0650M	FS10P3M0650M	25-650	262,98
40	1¼"	FS40P3M0600M	FS14P3M0600M	25-600	327,89
40	1¼"	FS40P3M1100M	FS14P3M1100M	55-1100	327,89
40	1¼"	FS40P3M1700M	FS14P3M1700M	100-1700	327,89
50	1½"	FS50P3M1000M	FS12P3M1000M	50-1000	392,82
50	1½"	FS50P3M1500M	FS12P3M1500M	100-1500	392,82
50	1½"	FS50P3M1600M	FS12P3M1600M	120-1600	392,82
63	2"	FS63P3M1700M	FS20P3M1700M	60-1700	512,67
63	2"	FS63P3M2500M	FS20P3M2500M	90-2500	512,67
63	2"	FS63P3M4000M	FS20P3M4000M	200-4000	512,67
75		FS75P3M6000M		670-6000	922,14
75		FS75P3M7500M		500-7500	922,14
75		FS75P3M0022M		4400-22000	922,14

Flujómetro largo para **Hidróxido de sodio (NaOH) 30%**.

Densidad: 1,33 kg/l - 20°C. Cuerpo: **POLYSULFON**. Juntas: **EPDM**.



FSIV / FSFV

encolar. roscar.

FLOTADOR INOX AISI 316

Diámetro		Ref. Encolar	Ref. Roscar	Escala l/h	€
Encolar	Roscar				
25	3/4"	FS25T5X0027	FS34T5X0027	1-27	136,47
25	3/4"	FS25T5X0070	FS34T5X0070	2,5-70	136,47
25	3/4"	FS25T5X0170	FS34T5X0170	5-170	136,47
25	3/4"	FS25T5X0350	FS34T5X0350	15-350	136,47
32	1"	FS32T5X0065	FS10T5X0065	2,5-65	154,80
32	1"	FS32T5X0145	FS10T5X0145	5-145	154,80
32	1"	FS32T5X0330	FS10T5X0330	10-330	154,80
32	1"	FS32T5X0675	FS10T5X0675	25-675	154,80
40	1 1/4"	FS40T5X0550	FS14T5X0550	25-550	209,70
40	1 1/4"	FS40T5X1100	FS14T5X1100	50-1100	209,70
40	1 1/4"	FS40T5X2000	FS14T5X2000	100-2000	209,70
50	1 1/2"	FS50T5X1000	FS12T5X1000	50-1000	246,35
50	1 1/2"	FS50T5X1900	FS12T5X1900	50-1900	246,35
50	1 1/2"	FS50T5X2500	FS12T5X2500	100-2500	246,35
63	2"	FS63T5X1800	FS20T5X1800	50-1800	329,58
63	2"	FS63T5X3100	FS20T5X3100	100-3100	329,58
63	2"	FS63T5X6000	FS20T5X6000	250-6000	329,58
75		FS75T5X9000		250-9000	574,24
75		FS75T5X0125		500-12500	574,24
75		FS75T5X0040		8200-40000	574,24

FLOTADOR PP ROJO

25	3/4"	FS25T5M0095	FS34T5M0095	0,5-9,5	136,47
25	3/4"	FS25T5M0023	FS34T5M0023	1,5-23	136,47
25	3/4"	FS25T5M0065	FS34T5M0065	3-65	136,47
25	3/4"	FS25T5M0145	FS34T5M0145	7-145	136,47
32	1"	FS32T5M0020	FS10T5M0020	1-20	154,80
32	1"	FS32T5M0050	FS10T5M0050	2,5-50	154,80
32	1"	FS32T5M0130	FS10T5M0130	5,5-130	154,80
32	1"	FS32T5M0260	FS10T5M0260	10-260	154,80
40	1 1/4"	FS40T5M0200	FS14T5M0200	10-200	209,70
40	1 1/4"	FS40T5M0500	FS14T5M0500	20-500	209,70
40	1 1/4"	FS40T5M0950	FS14T5M0950	25-950	209,70
50	1 1/2"	FS50T5M0425	FS12T5M0425	25-425	246,35
50	1 1/2"	FS50T5M0800	FS12T5M0800	25-800	246,35
50	1 1/2"	FS50T5M0950	FS12T5M0950	40-950	246,35
63	2"	FS63T5M0800	FS20T5M0800	30-800	329,58
63	2"	FS63T5M1400	FS20T5M1400	40-1400	329,58
63	2"	FS63T5M2500	FS20T5M2500	80-2500	329,58
75		FS75T5M3800		330-3800	574,24
75		FS75T5M5200		170-5200	574,24
75		FS75T5M0020		4100-20000	574,24

Flujómetro largo para **Hidróxido de sodio (NaOH) 50%**.
 Densidad: 1,53 kg/l - 20°C. Cuerpo: **PVC Transparente**. Juntas: **EPDM**.



FSIV / FSFV

encolar. roscar.

FLOTADOR INOX AISI 316 CON IMÁN INTERIOR incorporado para contacto exterior (suministrado aparte)

S1

Diámetro		Ref. Encolar	Ref. Roscar	Escala l/h	€
Encolar	Roscar				
25	¾"	FS25T5X0027M	FS34T5X0027M	1-27	198,08
25	¾"	FS25T5X0070M	FS34T5X0070M	2,5-70	198,08
25	¾"	FS25T5X0170M	FS34T5X0170M	5-170	198,08
25	¾"	FS25T5X0350M	FS34T5X0350M	15-350	198,08
32	1"	FS32T5X0065M	FS10T5X0065M	2,5-65	213,05
32	1"	FS32T5X0145M	FS10T5X0145M	5-145	213,05
32	1"	FS32T5X0330M	FS10T5X0330M	10-330	213,05
32	1"	FS32T5X0675M	FS10T5X0675M	25-675	213,05
40	1¼"	FS40T5X0550M	FS14T5X0550M	25-550	272,98
40	1¼"	FS40T5X1100M	FS14T5X1100M	50-1100	272,98
40	1¼"	FS40T5X2000M	FS14T5X2000M	100-2000	272,98
50	1½"	FS50T5X1000M	FS12T5X1000M	50-1000	314,60
50	1½"	FS50T5X1900M	FS12T5X1900M	50-1900	314,60
50	1½"	FS50T5X2500M	FS12T5X2500M	100-2500	314,60
63	2"	FS63T5X1800M	FS20T5X1800M	50-1800	407,81
63	2"	FS63T5X3100M	FS20T5X3100M	100-3100	407,81
63	2"	FS63T5X6000M	FS20T5X6000M	250-6000	407,81
75		FS75T5X9000M		250-9000	740,69
75		FS75T5X0125M		500-12500	740,69
75		FS75T5X0040M		8200-40000	740,69

FLOTADOR PP ROJO CON IMÁN INTERIOR incorporado para contacto exterior (suministrado aparte)

25	¾"	FS25T5M0095M	FS34T5M0095M	0,5-9,5	198,08
25	¾"	FS25T5M0023M	FS34T5M0023M	1,5-23	198,08
25	¾"	FS25T5M0065M	FS34T5M0065M	3-65	198,08
25	¾"	FS25T5M0145M	FS34T5M0145M	7-145	198,08
32	1"	FS32T5M0020M	FS10T5M0020M	1-20	213,05
32	1"	FS32T5M0050M	FS10T5M0050M	2,5-50	213,05
32	1"	FS32T5M0130M	FS10T5M0130M	5,5-130	213,05
32	1"	FS32T5M0260M	FS10T5M0260M	10-260	213,05
40	1¼"	FS40T5M0200M	FS14T5M0200M	10-200	272,98
40	1¼"	FS40T5M0500M	FS14T5M0500M	20-500	272,98
40	1¼"	FS40T5M0950M	FS14T5M0950M	25-950	272,98
50	1½"	FS50T5M0425M	FS12T5M0425M	25-425	314,60
50	1½"	FS50T5M0800M	FS12T5M0800M	25-800	314,60
50	1½"	FS50T5M0950M	FS12T5M0950M	40-950	314,60
63	2"	FS63T5M0800M	FS20T5M0800M	30-800	407,81
63	2"	FS63T5M1400M	FS20T5M1400M	40-1400	407,81
63	2"	FS63T5M2500M	FS20T5M2500M	80-2500	407,81
75		FS75T5M3800M		330-3800	740,69
75		FS75T5M5200M		170-5200	740,69
75		FS75T5M0020M		4100-20000	740,69

Flujómetro largo para **Hidróxido de sodio (NaOH) 50%**.

Densidad: 1,53 kg/l - 20°C. Cuerpo: PVC Transparente. Juntas: EPDM.



FSIV / FSFV

encolar. roscar.

FLOTADOR INOX AISI 316

Diámetro		Ref. Encolar	Ref. Roscar	Escala l/h	€
Encolar	Roscar				
25	¾"	FS25P5X0027	FS34P5X0027	1-27	178,09
25	¾"	FS25P5X0070	FS34P5X0070	2,5-70	178,09
25	¾"	FS25P5X0170	FS34P5X0170	5-170	178,09
25	¾"	FS25P5X0350	FS34P5X0350	15-350	178,09
32	1"	FS32P5X0065	FS10P5X0065	2,5-65	204,72
32	1"	FS32P5X0145	FS10P5X0145	5-145	204,72
32	1"	FS32P5X0330	FS10P5X0330	10-330	204,72
32	1"	FS32P5X0675	FS10P5X0675	25-675	204,72
40	1¼"	FS40P5X0550	FS14P5X0550	25-550	264,68
40	1¼"	FS40P5X1100	FS14P5X1100	50-1100	264,68
40	1¼"	FS40P5X2000	FS14P5X2000	100-2000	264,68
50	1½"	FS50P5X1000	FS12P5X1000	50-1000	324,58
50	1½"	FS50P5X1900	FS12P5X1900	50-1900	324,58
50	1½"	FS50P5X2500	FS12P5X2500	100-2500	324,58
63	2"	FS63P5X1800	FS20P5X1800	50-1800	434,42
63	2"	FS63P5X3100	FS20P5X3100	100-3100	434,42
63	2"	FS63P5X6000	FS20P5X6000	250-6000	434,42
75		FS75P5X9000		250-9000	755,68
75		FS75P5X0125		500-12500	755,68
75		FS75P5X0040		8200-40000	755,68

FLOTADOR PP ROJO

25	¾"	FS25P5M0095	FS34P5M0095	0,5-9,5	178,09
25	¾"	FS25P5M0023	FS34P5M0023	1,5-23	178,09
25	¾"	FS25P5M0065	FS34P5M0065	3-65	178,09
25	¾"	FS25P5M0145	FS34P5M0145	7-145	178,09
32	1"	FS32P5M0020	FS10P5M0020	1-20	204,72
32	1"	FS32P5M0050	FS10P5M0050	2,5-50	204,72
32	1"	FS32P5M0130	FS10P5M0130	5,5-130	204,72
32	1"	FS32P5M0260	FS10P5M0260	10-260	204,72
40	1¼"	FS40P5M0200	FS14P5M0200	10-200	264,68
40	1¼"	FS40P5M0500	FS14P5M0500	20-500	264,68
40	1¼"	FS40P5M0950	FS14P5M0950	25-950	264,68
50	1½"	FS50P5M0425	FS12P5M0425	25-425	324,58
50	1½"	FS50P5M0800	FS12P5M0800	25-800	324,58
50	1½"	FS50P5M0950	FS12P5M0950	40-950	324,58
63	2"	FS63P5M0800	FS20P5M0800	30-800	434,42
63	2"	FS63P5M1400	FS20P5M1400	40-1400	434,42
63	2"	FS63P5M2500	FS20P5M2500	80-2500	434,42
75		FS75P5M3800		330-3800	755,68
75		FS75P5M5200		170-5200	755,68
75		FS75P5M0020		4100-20000	755,68

Flujómetro largo para **Hidróxido de sodio (NaOH) 50%**.
 Densidad: 1,53 kg/l - 20°C. Cuerpo: **POLYSULFON**. Juntas: **EPDM**.



FSIV / FSFV

encolar. rosca.

FLOTADOR INOX AISI 316 CON IMÁN INTERIOR incorporado para contacto exterior (suministrado aparte)

S1

Diámetro		Ref. Encolar	Ref. Roscar	Escala l/h	€
Encolar	Roscar				
25	¾"	FS25P5X0027M	FS34P5X0027M	1-27	239,70
25	¾"	FS25P5X0070M	FS34P5X0070M	2,5-70	239,70
25	¾"	FS25P5X0170M	FS34P5X0170M	5-170	239,70
25	¾"	FS25P5X0350M	FS34P5X0350M	15-350	239,70
32	1"	FS32P5X0065M	FS10P5X0065M	2,5-65	262,98
32	1"	FS32P5X0145M	FS10P5X0145M	5-145	262,98
32	1"	FS32P5X0330M	FS10P5X0330M	10-330	262,98
32	1"	FS32P5X0675M	FS10P5X0675M	25-675	262,98
40	1¼"	FS40P5X0550M	FS14P5X0550M	25-550	327,89
40	1¼"	FS40P5X1100M	FS14P5X1100M	50-1100	327,89
40	1¼"	FS40P5X2000M	FS14P5X2000M	100-2000	327,89
50	1½"	FS50P5X1000M	FS12P5X1000M	50-1000	392,82
50	1½"	FS50P5X1900M	FS12P5X1900M	50-1900	392,82
50	1½"	FS50P5X2500M	FS12P5X2500M	100-2500	392,82
63	2"	FS63P5X1800M	FS20P5X1800M	50-1800	512,67
63	2"	FS63P5X3100M	FS20P5X3100M	100-3100	512,67
63	2"	FS63P5X6000M	FS20P5X6000M	250-6000	512,67
75		FS75P5X9000M		250-9000	922,14
75		FS75P5X0125M		500-12500	922,14
75		FS75P5X0040M		8200-40000	922,14

FLOTADOR PP ROJO CON IMÁN INTERIOR incorporado para contacto exterior (suministrado aparte)

25	¾"	FS25P5M0095M	FS34P5M0095M	0,5-9,5	239,70
25	¾"	FS25P5M0023M	FS34P5M0023M	1,5-23	239,70
25	¾"	FS25P5M0065M	FS34P5M0065M	3-65	239,70
25	¾"	FS25P5M0145M	FS34P5M0145M	7-145	239,70
32	1"	FS32P5M0020M	FS10P5M0020M	1-20	262,98
32	1"	FS32P5M0050M	FS10P5M0050M	2,5-50	262,98
32	1"	FS32P5M0130M	FS10P5M0130M	5,5-130	262,98
32	1"	FS32P5M0260M	FS10P5M0260M	10-260	262,98
40	1¼"	FS40P5M0200M	FS14P5M0200M	10-200	327,89
40	1¼"	FS40P5M0500M	FS14P5M0500M	20-500	327,89
40	1¼"	FS40P5M0950M	FS14P5M0950M	25-950	327,89
50	1½"	FS50P5M0425M	FS12P5M0425M	25-425	392,82
50	1½"	FS50P5M0800M	FS12P5M0800M	25-800	392,82
50	1½"	FS50P5M0950M	FS12P5M0950M	40-950	392,82
63	2"	FS63P5M0800M	FS20P5M0800M	30-800	512,67
63	2"	FS63P5M1400M	FS20P5M1400M	40-1400	512,67
63	2"	FS63P5M2500M	FS20P5M2500M	80-2500	512,67
75		FS75P5M3800M		330-3800	922,14
75		FS75P5M5200M		170-5200	922,14
75		FS75P5M0020M		4100-20000	922,14

Flujómetro largo para **Hidróxido de sodio (NaOH) 50%**.

Densidad: 1,53 kg/l - 20°C. Cuerpo: POLYSULFON. Juntas: EPDM.



FSIV / FSFV

encolar. roscar.

FLOTADOR PP ROJO

Diámetro		Ref. Encolar	Ref. Roscar	Escala l/h	€
Encolar	Roscar				
25	3/4"	FS25T2M0140	FS34T2M0140	14-140	136,47
25	3/4"	FS25T2M0230	FS34T2M0230	23-230	136,47
25	3/4"	FS25T2M0420	FS34T2M0420	42-420	136,47
25	3/4"	FS25T2M0650	FS34T2M0650	65-650	136,47
32	1"	FS32T2M0230	FS10T2M0230	23-230	154,80
32	1"	FS32T2M0370	FS10T2M0370	37-370	154,80
32	1"	FS32T2M0600	FS10T2M0600	60-600	154,80
32	1"	FS32T2M0900	FS10T2M0900	90-900	154,80
40	1 1/4"	FS40T2M0900	FS14T2M0900	90-900	209,70
40	1 1/4"	FS40T2M1500	FS14T2M1500	150-1500	209,70
40	1 1/4"	FS40T2M2300	FS14T2M2300	200-2300	209,70
50	1 1/2"	FS50T2M1500	FS12T2M1500	140-1500	246,35
50	1 1/2"	FS50T2M2000	FS12T2M2000	190-2000	246,35
50	1 1/2"	FS50T2M2300	FS12T2M2300	230-2300	246,35
63	2"	FS63T2M2300	FS20T2M2300	230-2300	329,58
63	2"	FS63T2M3200	FS20T2M3200	330-3200	329,58
63	2"	FS63T2M4600	FS20T2M4600	470-4600	329,58
75		FS75T2M7500		950-7500	574,24
75		FS75T2M9300		930-9300	574,24
75		FS75T2M0023		4700-23000	574,24

FLOTADOR PP ROJO CON IMÁN INTERIOR

incorporado para contacto exterior (suministrado aparte)

25	3/4"	FS25T2M0140M	FS34T2M0140M	14-140	198,08
25	3/4"	FS25T2M0230M	FS34T2M0230M	23-230	198,08
25	3/4"	FS25T2M0420M	FS34T2M0420M	42-420	198,08
25	3/4"	FS25T2M0650M	FS34T2M0650M	65-650	198,08
32	1"	FS32T2M0230M	FS10T2M0230M	23-230	213,05
32	1"	FS32T2M0370M	FS10T2M0370M	37-370	213,05
32	1"	FS32T2M0600M	FS10T2M0600M	60-600	213,05
32	1"	FS32T2M0900M	FS10T2M0900M	90-900	213,05
40	1 1/4"	FS40T2M0900M	FS14T2M0900M	90-900	272,98
40	1 1/4"	FS40T2M1500M	FS14T2M1500M	150-1500	272,98
40	1 1/4"	FS40T2M2300M	FS14T2M2300M	200-2300	272,98
50	1 1/2"	FS50T2M1500M	FS12T2M1500M	140-1500	314,60
50	1 1/2"	FS50T2M2000M	FS12T2M2000M	190-2000	314,60
50	1 1/2"	FS50T2M2300M	FS12T2M2300M	230-2300	314,60
63	2"	FS63T2M2300M	FS20T2M2300M	230-2300	407,81
63	2"	FS63T2M3200M	FS20T2M3200M	330-3200	407,81
63	2"	FS63T2M4600M	FS20T2M4600M	470-4600	407,81
75		FS75T2M7500M		950-7500	740,69
75		FS75T2M9300M		930-9300	740,69
75		FS75T2M0023M		4700-23000	740,69

Flujómetro largo para **Ácido clorhídrico (HCl) 30-33%**.

Densidad: 1,16 kg/l - 20°C. Cuerpo: **PVC Transparente**. Juntas: **EPDM**.



FSIV / FSFV

encolar. roscar.

FLOTADOR PP ROJO

Diámetro		Ref. Encolar	Ref. Roscar	Escala l/h	€
Encolar	Roscar				
25	¾"	FS25P2M0140	FS34P2M0140	14-140	178,09
25	¾"	FS25P2M0230	FS34P2M0230	23-230	178,09
25	¾"	FS25P2M0420	FS34P2M0420	42-420	178,09
25	¾"	FS25P2M0650	FS34P2M0650	65-650	178,09
32	1"	FS32P2M0230	FS10P2M0230	23-230	204,72
32	1"	FS32P2M0370	FS10P2M0370	37-370	204,72
32	1"	FS32P2M0600	FS10P2M0600	60-600	204,72
32	1"	FS32P2M0900	FS10P2M0900	90-900	204,72
40	1¼"	FS40P2M0900	FS14P2M0900	90-900	264,68
40	1¼"	FS40P2M1500	FS14P2M1500	150-1500	264,68
40	1¼"	FS40P2P2300	FS14P2P2300	200-2300	264,68
50	1½"	FS50P2M1500	FS12P2M1500	140-1500	324,58
50	1½"	FS50P2P2000	FS12P2P2000	190-2000	324,58
50	1½"	FS50P2P2300	FS12P2P2300	230-2300	324,58
63	2"	FS63P2P2300	FS20P2P2300	230-2300	434,42
63	2"	FS63P2M3200	FS20P2M3200	330-3200	434,42
63	2"	FS63P2M4600	FS20P2M4600	470-4600	434,42
75		FS75P2M7500		950-7500	755,68
75		FS75P2M9300		930-9300	755,68
75		FS75P2M0023		4700-23000	755,68

FLOTADOR PP ROJO CON IMÁN INTERIOR incorporado para contacto exterior (suministrado aparte)

25	¾"	FS25P2M0140M	FS34P2M0140M	14-140	239,70
25	¾"	FS25P2M0230M	FS34P2M0230M	23-230	239,70
25	¾"	FS25P2M0420M	FS34P2M0420M	42-420	239,70
25	¾"	FS25P2M0650M	FS34P2M0650M	65-650	239,70
32	1"	FS32P2M0230M	FS10P2M0230M	23-230	262,98
32	1"	FS32P2M0370M	FS10P2M0370M	37-370	262,98
32	1"	FS32P2M0600M	FS10P2M0600M	60-600	262,98
32	1"	FS32P2M0900M	FS10P2M0900M	90-900	262,98
40	1¼"	FS40P2M0900M	FS14P2M0900M	90-900	327,89
40	1¼"	FS40P2M1500M	FS14P2M1500M	150-1500	327,89
40	1¼"	FS40P2M2300M	FS14P2M2300M	200-2300	327,89
50	1½"	FS50P2M1500M	FS12P2M1500M	140-1500	392,82
50	1½"	FS50P2M2000M	FS12P2M2000M	190-2000	392,82
50	1½"	FS50P2M2300M	FS12P2M2300M	230-2300	392,82
63	2"	FS63P2M2300M	FS20P2M2300M	230-2300	512,67
63	2"	FS63P2M3200M	FS20P2M3200M	330-3200	512,67
63	2"	FS63P2M4600M	FS20P2M4600M	470-4600	512,67
75		FS75P2M7500M		950-7500	922,14
75		FS75P2M9300M		930-9300	922,14
75		FS75P2M0023M		4700-23000	922,14

Flujómetro largo para **Ácido clorhídrico (HCl) 30-33%**.
 Densidad: 1,16 kg/l - 20°C. Cuerpo: **POLYSULFON**. Juntas: **EPDM**.



FSIV / FSFV

encolar. roscar.

FLOTADOR PP ROJO

Diámetro		Ref. Encolar	Ref. Roscar	Escala Nm³/h	€
Encolar	Roscar				
25	¾"	FS25D0M0025	FS34D0M0025	0,2-2,5	149,80
25	¾"	FS25D0M0004	FS34D0M0004	0,3-4	149,80
25	¾"	FS25D0M0065	FS34D0M0065	0,5-6,5	149,80
25	¾"	FS25D0M0010	FS34D0M0010	1-10	149,80
32	1"	FS32D0M0004	FS10D0M0004	0,4-4	168,10
32	1"	FS32D0M0065	FS10D0M0065	0,5-6,5	168,10
32	1"	FS32D0M0010	FS10D0M0010	1-10	168,10
32	1"	FS32D0M0016	FS10D0M0016	1,5-16	168,10
40	1¼"	FS40D0M0016	FS14D0M0016	1,5-16	224,70
40	1¼"	FS40D0M0025	FS14D0M0025	2-25	224,70
40	1¼"	FS40D0M0040	FS14D0M0040	4-40	224,70
50	1½"	FS50D0M0025	FS12D0M0025	2-25	261,33
50	1½"	FS50D0M0040	FS12D0M0040	4-40	261,33
50	1½"	FS50D0M0050	FS12D0M0050	5-50	261,33
63	2"	FS63D0M0040	FS20D0M0040	4-40	341,19
63	2"	FS63D0M0064	FS20D0M0064	6-64	341,19
63	2"	FS63D0M0100	FS20D0M0100	10-100	341,19
75		FS75D0M0140		15-140	584,23
75		FS75D0M0200		20-200	584,23

FLOTADOR PP ROJO CON IMÁN INTERIOR incorporado para contacto exterior (suministrado aparte)

25	¾"	FS25D0M0025M	FS34D0M0025M	0,2-2,5	211,39
25	¾"	FS25D0M0004M	FS34D0M0004M	0,3-4	211,39
25	¾"	FS25D0M0065M	FS34D0M0065M	0,5-6,5	211,39
25	¾"	FS25D0M0010M	FS34D0M0010M	1-10	211,39
32	1"	FS32D0M0004M	FS10D0M0004M	0,4-4	226,37
32	1"	FS32D0M0065M	FS10D0M0065M	0,5-6,5	226,37
32	1"	FS32D0M0010M	FS10D0M0010M	1-10	226,37
32	1"	FS32D0M0016M	FS10D0M0016M	1,5-16	226,37
40	1¼"	FS40D0M0016M	FS14D0M0016M	1,5-16	287,96
40	1¼"	FS40D0M0025M	FS14D0M0025M	2-25	287,96
40	1¼"	FS40D0M0040M	FS14D0M0040M	4-40	287,96
50	1½"	FS50D0M0025M	FS12D0M0025M	2-25	297,15
50	1½"	FS50D0M0040M	FS12D0M0040M	4-40	297,15
50	1½"	FS50D0M0050M	FS12D0M0050M	5-50	297,15
63	2"	FS63D0M0040M	FS20D0M0040M	4-40	419,46
63	2"	FS63D0M0064M	FS20D0M0064M	6-64	419,46
63	2"	FS63D0M0100M	FS20D0M0100M	10-100	419,46
75		FS75D0M0140M		15-140	744,17
75		FS75D0M0200M		20-200	744,17

Flujómetro largo para **Aire**.

Densidad: 1,013 bar abs. - 20°C. Cuerpo: **TROGAMID**. Juntas: **EPDM**.



S1

Ref.	Descripción	€
MSMIN01	Contacto de MÍNIMA para flujómetros FS *	99,62
MSMAX01	Contacto de MÁXIMA para flujómetros FS *	99,62
	Escala especial	Consultar
	Doble escala	Consultar

Contactos exteriores.

Sólo utilizables con flujómetros que incorporen imán exterior
* Para usar con flotador con imán incorporado



I

d	Ref.	Descripción	€
25	QBIC025	Manguito C-PVC	8,33
32	QBIC032	Manguito C-PVC	10,83
40	QBIC040	Manguito C-PVC	13,28
50	QBIC050	Manguito C-PVC	17,68
63	QBIC063	Manguito C-PVC	23,60
25	QBIGM025	Manguito PP-H	3,08
32	QBIGM032	Manguito PP-H	3,28
40	QBIGM040	Manguito PP-H	4,06
50	QBIGM050	Manguito PP-H	4,86
63	QBIGM063	Manguito PP-H	5,17
25	QBIGF025	Manguito PVDF	11,72
32	QBIGF032	Manguito PVDF	13,06
40	QBIGF040	Manguito PVDF	16,66
50	QBIGF050	Manguito PVDF	18,98
63	QBIGF063	Manguito PVDF	26,33

Manguitos. Para cada flujómetro es necesario pedir 2 manguitos

d	Ref.	Descripción	€
25	EFC114	Tuerca C-PVC	7,38
32	EFC112	Tuerca C-PVC	10,70
40	EFC200	Tuerca C-PVC	12,17
50	EFC214	Tuerca C-PVC	19,93
63	EFC234	Tuerca C-PVC	28,43
25	EFGM114	Tuerca PP-H	6,00
32	EFGM112	Tuerca PP-H	6,96
40	EFGM200	Tuerca PP-H	8,89
50	EFGM214	Tuerca PP-H	13,77
63	EFGM234	Tuerca PP-H	22,20
25	EFGF114	Tuerca PVDF	20,38
32	EFGF112	Tuerca PVDF	25,27
40	EFGF200	Tuerca PVDF	34,74
50	EFGF214	Tuerca PVDF	50,67
63	EFGF234	Tuerca PVDF	78,78

Tuercas. Para cada flujómetro es necesario pedir 2 tuercas

25	OR4112F	Junta FKM	2,00
32	OR4131F	Junta FKM	5,65
40	OR0150F	Junta FKM	11,12
50	OR4200F	Junta FKM	8,67
63	OR4275F	Junta FKM	13,80
75	OR6325F	Junta FKM	22,15

Juntas.

Para cada flujómetro es necesario pedir 2 juntas

Bajo pedido disponemos también de conexiones rosca hembra de 3/8" a 1" en acero inoxidable AISI 316 y en acero al carbono.



M9.02

R

Ref.	Montaje	Salidas	Voltaje	€
M9.02.P1	En panel	1x(4-20mA), 2x(S.S.R.), 1 relé	12-24 VDC	682,00
M9.02.W1	En pared	1x(4-20mA), 2x(S.S.R.), 1 relé	12-24 VDC	789,10
M9.02.W2	En pared	1x(4-20mA), 2x(S.S.R.), 1 relé	110-230 VAC	890,25

Monitor y transmisor de caudal.

Para sensores de caudal.



M9.02

R

Ref.	Longitud sensor	Material sensor	Juntas	Voltaje	€
M9.02.01	L0	C-PVC	EPDM	12-24 VDC	1.151,22
M9.02.02	L0	C-PVC	FKM	12-24 VDC	1.151,22
M9.02.03	L1	PVDF	EPDM	12-24 VDC	1.169,50
M9.02.04	L1	PVDF	FKM	12-24 VDC	1.169,50
M9.02.05	L0	PVDF	EPDM	12-24 VDC	1.273,06
M9.02.06	L0	PVDF	FKM	12-24 VDC	1.273,06
M9.02.07	L1	PVDF	EPDM	12-24 VDC	1.463,46
M9.02.08	L1	PVDF	FKM	12-24 VDC	1.463,46
M9.02.09	L0	INOX 316 L	EPDM	12-24 VDC	1.450,19
M9.02.10	L0	INOX 316 L	FKM	12-24 VDC	1.450,19
M9.02.11	L1	INOX 316 L	EPDM	12-24 VDC	1.482,73
M9.02.12	L1	INOX 316 L	FKM	12-24 VDC	1.482,73

Monitor y transmisor de caudal con sensor de paletas.

Montaje directo y compacto. Salidas 1x(4-20mA), 2x(S.S.R.), 1 relé.



M9.00

R

Ref.	Longitud sensor	Material sensor	Juntas	Voltaje	€
M9.00.01	L0	C-PVC	EPDM	12-24 VDC	1.075,57
M9.00.02	L0	C-PVC	FKM	12-24 VDC	1.075,57
M9.00.03	L1	PVDF	EPDM	12-24 VDC	1.093,86
M9.00.04	L1	PVDF	FKM	12-24 VDC	1.093,86
M9.00.05	L0	PVDF	EPDM	12-24 VDC	1.197,43
M9.00.06	L0	PVDF	FKM	12-24 VDC	1.197,43
M9.00.07	L1	PVDF	EPDM	12-24 VDC	1.387,84
M9.00.08	L1	PVDF	FKM	12-24 VDC	1.387,84
M9.00.09	L0	INOX 316 L	EPDM	12-24 VDC	1.374,58
M9.00.10	L0	INOX 316 L	FKM	12-24 VDC	1.374,58
M9.00.11	L1	INOX 316 L	EPDM	12-24 VDC	1.407,12
M9.00.12	L1	INOX 316 L	FKM	12-24 VDC	1.407,12

Monitor y transmisor de caudal **2 HILOS** con sensor de paletas.

Montaje directo y compacto. Salidas 1x(4-20mA), 1x(S.S.R.).



M9.00

R

Ref.	Montaje	Salidas	Voltaje	€
M9.00.P1	En panel	1x(4-20mA), 1x(S.S.R.)	12-24 VDC	613,87
M9.00.W1	En pared	1x(4-20mA), 1x(S.S.R.)	12-24 VDC	721,00
M9.00.W2	En pared	1x(4-20mA), 1x(S.S.R.)	110-230 VAC	822,16

Monitor y transmisor de caudal **2 HILOS.**

Para sensores de caudal.

Longitud L0 para diámetros de ø 20-110 mm. Longitud L1 para diámetros de 125-450 mm.

El pedido estándar se compone de sensor + pantalla + accesorios de conexión al tubo. Disponemos de instrucciones de funcionamiento de los modelos.



M9.20

R

Ref.	Montaje	€
M9.20.P1	En panel	705,94
M9.20.W1	En pared	813,07

Monitor de caudal **A BATERÍAS**.

Para sensores de caudal.



M9.20

R

Ref.	Longitud sensor	Material sensor	Juntas	€
M9.20.01	L0	C-PVC	EPDM	1.177,86
M9.20.02	L0	C-PVC	FKM	1.177,86
M9.20.03	L1	PVDF	EPDM	1.196,15
M9.20.04	L1	PVDF	FKM	1.196,15
M9.20.05	L0	PVDF	EPDM	1.299,72
M9.20.06	L0	PVDF	FKM	1.299,72
M9.20.07	L1	PVDF	EPDM	1.490,14
M9.20.08	L1	PVDF	FKM	1.490,14
M9.20.09	L0	INOX 316 L	EPDM	1.476,89
M9.20.10	L0	INOX 316 L	FKM	1.476,89
M9.20.11	L1	INOX 316 L	EPDM	1.509,42
M9.20.12	L1	INOX 316 L	FKM	1.509,42

Monitor de caudal con sensor de paletas **A BATERÍAS**.

Montaje directo y compacto.



M9.50

R

Ref.	Montaje	Salidas	Voltaje	€
M9.50.P1	En panel	2x(4-20mA), 2x(S.S.R.), 2 relés	12-24 VDC	941,07
M9.50.W1	En pared	2x(4-20mA), 2x(S.S.R.), 2 relés	12-24 VDC	1.076,38
M9.50.W2	En pared	2x(4-20mA), 2x(S.S.R.), 2 relés	110-230 VAC	1.205,58

Monitor de control de trasvase. Para sensores de caudal.



M9.03

R

Ref.	Montaje	Salidas	Voltaje	€
M9.03.P1	En panel	2x(4-20mA), 2x(S.S.R.), 2 relés	12-24 VDC	1.213,52
M9.03.W1	En pared	2x(4-20mA), 2x(S.S.R.), 2 relés	12-24 VDC	1.356,32
M9.03.W2	En pared	2x(4-20mA), 2x(S.S.R.), 2 relés	110-230 VAC	1.491,20

Monitor y transmisor de caudal **DOBLE**. Para sensores de caudal.



M9.05

R

Ref.	Montaje	Salidas	Voltaje	€
M9.05.P1	En panel	2x(4-20mA), 2x(S.S.R.), 2 relés	12-24 VDC	907,57
M9.05.W1	En pared	2x(4-20mA), 2x(S.S.R.), 2 relés	12-24 VDC	1.050,35
M9.05.W2	En pared	2x(4-20mA), 2x(S.S.R.), 2 relés	110-230 VAC	1.185,20

Monitor y transmisor de conductividad. Para sensores de conductividad.

Longitud L0 para diámetros de ø 20-110 mm. Longitud L1 para diámetros de 125-450 mm.

El pedido estándar se compone de sensor + pantalla + accesorios de conexión al tubo. Disponemos de instrucciones de funcionamiento de los modelos.



M9.06

R

Ref.	Montaje	Salidas	Voltaje	€
M9.06.P1	En panel	2x(4-20mA), 2x(S.S.R.), 2 reles	12-24 VDC	914,88
M9.06.W1	En pared	2x(4-20mA), 2x(S.S.R.), 2 reles	12-24 VDC	1.057,67
M9.06.W2	En pared	2x(4-20mA), 2x(S.S.R.), 2 reles	110-230 VAC	1.192,50

Monitor y transmisor de pH / ORP.

Para sensores de pH/ORP.



M9.07

R

Ref.	Montaje	Salidas	Voltaje	€
M9.07.P1	En panel	2x(4-20mA), 2x(S.S.R.), 2 reles	12-24 VDC	1.211,81
M9.07.W1	En pared	2x(4-20mA), 2x(S.S.R.), 2 reles	12-24 VDC	1.354,68
M9.07.W2	En pared	2x(4-20mA), 2x(S.S.R.), 2 reles	110-230 VAC	1.489,55

Monitor y transmisor de doble parámetro: **CONDUCTIVIDAD - CAUDAL**.



M9.08

R

Ref.	Montaje	Salidas	Voltaje	€
M9.08.P1	En panel	2x(4-20mA), 2x(S.S.R.), 2 reles	12-24 VDC	1.219,19
M9.08.W1	En pared	2x(4-20mA), 2x(S.S.R.), 2 reles	12-24 VDC	1.361,98
M9.08.W2	En pared	2x(4-20mA), 2x(S.S.R.), 2 reles	110-230 VAC	1.496,84

Monitor y transmisor de doble parámetro: **pH / ORP - CAUDAL**.



M9.10

R

Ref.	Montaje	Salidas	Voltaje	€
M9.10.P1	En panel	2x(4-20mA), 2x(S.S.R.), 2 reles	12-24 VDC	1.156,31
M9.10.W1	En pared	2x(4-20mA), 2x(S.S.R.), 2 reles	12-24 VDC	1.299,11
M9.10.W2	En pared	2x(4-20mA), 2x(S.S.R.), 2 reles	110-230 VAC	1.433,98

Monitor y transmisor analógico de doble parámetro.

Longitud L0 para diámetros de ø 20-110 mm. Longitud L1 para diámetros de 125-450 mm.

El pedido estándar se compone de sensor + pantalla + accesorios de conexión al tubo. Disponemos de instrucciones de funcionamiento de los modelos.



F3.00.H.XX

Ref.	Longitud sensor	Material sensor	Juntas	Protección	€
F3.00.H.01	L0	C-PVC	EPDM	IP68	320,93
F3.00.H.02	L0	C-PVC	FKM	IP68	320,93
F3.00.H.03	L1	C-PVC	EPDM	IP68	336,93
F3.00.H.04	L1	C-PVC	FKM	IP68	336,93
F3.00.H.05	L0	PVDF	EPDM	IP68	429,44
F3.00.H.06	L0	PVDF	FKM	IP68	429,44
F3.00.H.07	L1	PVDF	EPDM	IP68	557,36
F3.00.H.08	L1	PVDF	FKM	IP68	557,36
F3.00.H.09	L0	INOX 316	EPDM	IP68	600,99
F3.00.H.10	L0	INOX 316	FKM	IP68	600,99
F3.00.H.11	L1	INOX 316	EPDM	IP68	630,94
F3.00.H.12	L1	INOX 316	FKM	IP68	630,94

Sensor de caudal de paletas versión remota
Alimentación 12-24 VDC. **VERSIÓN HALL.**

R

Ref.	Longitud sensor	Material sensor	Juntas	Protección	€
F3.00.H.13	L0	C-PVC	EPDM	IP65	320,93
F3.00.H.14	L0	C-PVC	FKM	IP65	320,93
F3.00.H.15	L1	PVDF	EPDM	IP65	336,93
F3.00.H.16	L1	PVDF	FKM	IP65	336,93
F3.00.H.17	L0	PVDF	EPDM	IP65	429,44
F3.00.H.18	L0	PVDF	FKM	IP65	429,44
F3.00.H.19	L1	PVDF	EPDM	IP65	557,36
F3.00.H.20	L1	PVDF	FKM	IP65	557,36
F3.00.H.21	L0	INOX 316	EPDM	IP65	600,99
F3.00.H.22	L0	INOX 316	FKM	IP65	600,99
F3.00.H.23	L1	INOX 316	EPDM	IP65	630,94
F3.00.H.24	L1	INOX 316	FKM	IP65	630,94

Marcados en amarillo los modelos estándar

F3.00.C.XX

Ref.	Longitud sensor	Material sensor	Juntas	Protección	€
F3.00.C.01	L0	C-PVC	EPDM	IP68	320,93
F3.00.C.02	L0	C-PVC	FKM	IP68	320,93
F3.00.C.03	L1	PVDF	EPDM	IP68	336,93
F3.00.C.04	L1	PVDF	FKM	IP68	336,93
F3.00.C.05	L0	PVDF	EPDM	IP68	429,44
F3.00.C.06	L0	PVDF	FKM	IP68	429,44
F3.00.C.07	L1	PVDF	EPDM	IP68	557,36
F3.00.C.08	L1	PVDF	FKM	IP68	557,36
F3.00.C.09	L0	INOX 316	EPDM	IP68	600,99
F3.00.C.10	L0	INOX 316	FKM	IP68	600,99
F3.00.C.11	L1	INOX 316	EPDM	IP68	630,94
F3.00.C.12	L1	INOX 316	FKM	IP68	630,94

Sensor de caudal de paletas versión remota
Alimentación 3-5 VDC. **VERSIÓN COIL.**



R

Ref.	Longitud sensor	Material sensor	Juntas	Protección	€
F3.00.C.13	L0	C-PVC	EPDM	IP65	320,93
F3.00.C.14	L0	C-PVC	FKM	IP65	320,93
F3.00.C.15	L1	PVDF	EPDM	IP65	336,93
F3.00.C.16	L1	PVDF	FKM	IP65	336,93
F3.00.C.17	L0	PVDF	EPDM	IP65	429,44
F3.00.C.18	L0	PVDF	FKM	IP65	429,44
F3.00.C.19	L1	PVDF	EPDM	IP65	557,36
F3.00.C.20	L1	PVDF	FKM	IP65	557,36
F3.00.C.21	L0	INOX 316	EPDM	IP65	600,99
F3.00.C.22	L0	INOX 316	FKM	IP65	600,99
F3.00.C.23	L1	INOX 316	EPDM	IP65	630,94
F3.00.C.24	L1	INOX 316	FKM	IP65	630,94

Longitud L0 para diámetros de ø 20-110 mm. Longitud L1 para diámetros de 125-450 mm.

El pedido estándar se compone de sensor + pantalla + accesorios de conexión al tubo. Disponemos de instrucciones de funcionamiento de los modelos.



F3.00.P.XX

R

Ref.	Longitud sensor	Material sensor	Juntas	Protección	€
F3.00.P.01	L0	C-PVC	EPDM	IP68	336,93
F3.00.P.02	L0	C-PVC	FKM	IP68	336,93
F3.00.P.03	L1	PVDF	EPDM	IP68	344,92
F3.00.P.04	L1	PVDF	FKM	IP68	344,92
F3.00.P.05	L0	PVDF	EPDM	IP68	448,84
F3.00.P.06	L0	PVDF	FKM	IP68	448,84
F3.00.P.07	L1	PVDF	EPDM	IP68	568,77
F3.00.P.08	L1	PVDF	FKM	IP68	568,77
F3.00.P.09	L0	INOX 316	EPDM	IP68	608,75
F3.00.P.10	L0	INOX 316	FKM	IP68	608,75
F3.00.P.11	L1	INOX 316	EPDM	IP68	639,81
F3.00.P.12	L1	INOX 316	FKM	IP68	639,81

Ref.	Longitud sensor	Material sensor	Juntas	Protección	€
F3.00.P.13	L0	C-PVC	EPDM	IP65	336,93
F3.00.P.14	L0	C-PVC	FKM	IP65	336,93
F3.00.P.15	L1	PVDF	EPDM	IP65	344,92
F3.00.P.16	L1	PVDF	FKM	IP65	344,92
F3.00.P.17	L0	PVDF	EPDM	IP65	448,84
F3.00.P.18	L0	PVDF	FKM	IP65	448,84
F3.00.P.19	L1	PVDF	EPDM	IP65	568,77
F3.00.P.20	L1	PVDF	FKM	IP65	568,77
F3.00.P.21	L0	INOX 316	EPDM	IP65	608,75
F3.00.P.22	L0	INOX 316	FKM	IP65	608,75
F3.00.P.23	L1	INOX 316	EPDM	IP65	639,81
F3.00.P.24	L1	INOX 316	FKM	IP65	639,81

Sensor de caudal de paletas versión remota.

Alimentación 12-24 VDC. [Para conexión directa a PLC.](#)



IP68



IP65

F3.01.H.XX

R

Ref.	Longitud sensor	Material sensor	Juntas	Protección	€
F3.01.H.01	L0	C-PVC	EPDM	IP68	259,26
F3.01.H.02	L0	C-PVC	FKM	IP68	259,26
F3.01.H.03	L1	PVDF	EPDM	IP68	272,97
F3.01.H.04	L1	PVDF	FKM	IP68	272,97
F3.01.H.05	L0	PVDF	EPDM	IP68	350,62
F3.01.H.06	L0	PVDF	FKM	IP68	350,62
F3.01.H.07	L1	PVDF	EPDM	IP68	493,41
F3.01.H.08	L1	PVDF	FKM	IP68	493,41
F3.01.H.09	L0	INOX 316	EPDM	IP68	483,46
F3.01.H.10	L0	INOX 316	FKM	IP68	483,46
F3.01.H.11	L1	INOX 316	EPDM	IP68	507,86
F3.01.H.12	L1	INOX 316	FKM	IP68	507,86

Recambio sensor de caudal de paletas versión compacta.

Alimentación 5-24 VDC. [VERSIÓN HALL.](#)

F3.01.C.XX

R

Ref.	Longitud sensor	Material sensor	Juntas	Protección	€
F3.01.C.01	L0	C-PVC	EPDM	IP68	259,26
F3.01.C.02	L0	C-PVC	FKM	IP68	259,26
F3.01.C.03	L1	PVDF	EPDM	IP68	272,97
F3.01.C.04	L1	PVDF	FKM	IP68	272,97
F3.01.C.05	L0	PVDF	EPDM	IP68	350,62
F3.01.C.06	L0	PVDF	FKM	IP68	350,62
F3.01.C.07	L1	PVDF	EPDM	IP68	493,41
F3.01.C.08	L1	PVDF	FKM	IP68	493,41
F3.01.C.09	L0	INOX 316	EPDM	IP68	483,46
F3.01.C.10	L0	INOX 316	FKM	IP68	483,46
F3.01.C.11	L1	INOX 316	EPDM	IP68	507,86
F3.01.C.12	L1	INOX 316	FKM	IP68	507,86

Recambio sensor de caudal de paletas versión compacta.

Alimentación 3-5 VDC. [VERSIÓN COIL.](#)

Longitud L0 para diámetros de ø 20-110 mm. Longitud L1 para diámetros de 125-450 mm.

El pedido estándar se compone de sensor + pantalla + accesorios de conexión al tubo. Disponemos de instrucciones de funcionamiento de los modelos.



F3.20.X.01

R

Ref.	Longitud sensor mm.	Material sensor	Versión	Protección	€
F3.20.H.01	107	INOX 316	HALL	IP68	503,84
F3.20.P.01	107	INOX 316	Directo a PLC	IP68	529,04

Sensor de caudal de paletas para
ALTAS PRESIONES Y TEMPERATURAS.



F3.10.H.XX

R

Ref.	Longitud sensor mm.	Material sensor	Juntas	Protección	€
F3.10.H.01	41	ABS	EPDM	IP65	132,47
F3.10.P.01	41	ABS	FKM	IP65	132,47

Minisensor de caudal de paletas
 Alimentación 5-24 VDC. **VERSIÓN HALL.**



F6.30

R

Ref.	Longitud sensor	Material sensor	Juntas	Protección	€
F6.30.01	L0	C-PVC	EPDM	IP65	844,21
F6.30.02	L0	C-PVC	FKM	IP65	844,21
F6.30.03	L1	PVDF	EPDM	IP65	863,72
F6.30.04	L1	PVDF	FKM	IP65	863,72
F6.30.05	L0	PVDF	EPDM	IP65	974,33
F6.30.06	L0	PVDF	FKM	IP65	974,33
F6.30.07	L1	PVDF	EPDM	IP65	1.177,65
F6.30.08	L1	PVDF	FKM	IP65	1.177,65
F6.30.09	L0	INOX 316	EPDM	IP65	1.184,18
F6.30.10	L0	INOX 316	FKM	IP65	1.184,18
F6.30.11	L1	INOX 316	EPDM	IP65	1.219,95
F6.30.12	L1	INOX 316	FKM	IP65	1.219,95

Transmisor de caudal de paletas **CON SALIDA 4-20 mA.**
 Alimentación 5-24 VDC. **VERSIÓN HALL.**
 Rango caudal: 0,15 - 8 m/s.



F3.05.XX

R

Ref.	Longitud sensor	Material sensor	Juntas	Protección	€
F3.05.01	L0	C-PVC	EPDM	IP65	288,31
F3.05.02	L0	C-PVC	FKM	IP65	288,31
F3.05.03	L1	PVDF	EPDM	IP65	306,04
F3.05.04	L1	PVDF	FKM	IP65	306,04
F3.05.05	L0	PVDF	EPDM	IP65	450,21
F3.05.06	L0	PVDF	FKM	IP65	450,21
F3.05.07	L1	PVDF	EPDM	IP65	477,91
F3.05.08	L1	PVDF	FKM	IP65	477,91
F3.05.09	L0	INOX 316	EPDM	IP65	546,66
F3.05.10	L0	INOX 316	FKM	IP65	546,66
F3.05.11	L1	INOX 316	EPDM	IP65	574,40
F3.05.12	L1	INOX 316	FKM	IP65	574,40

Sensor de caudal de paletas.
INTERRUPTOR DE CAUDAL. BATCH CONTROLER.
 Transmite una señal de apertura al detectar ausencia de caudal.

Longitud L0 para diámetros de ø 20-110 mm. Longitud L1 para diámetros de 125-450 mm.
 El pedido estándar se compone de sensor + pantalla + accesorios de conexión al tubo. Disponemos de instrucciones de funcionamiento de los modelos.



F6.60

R

Ref.	Longitud sensor	Material sensor	Juntas	Protección	€
F6.60.09	L0	INOX 316L/PVDF	EPDM	IP65	1.343,12
F6.60.10	L0	INOX 316L/PVDF	FKM	IP65	1.343,12
F6.60.11	L1	INOX 316L/PVDF	EPDM	IP65	1.379,06
F6.60.12	L1	INOX 316L/PVDF	FKM	IP65	1.379,06
F6.60.33	L0	CuNi/PVDF	EPDM	IP65	1.468,89
F6.60.34	L0	CuNi/PVDF	FKM	IP65	1.468,89
F6.60.35	L1	CuNi/PVDF	EPDM	IP65	1.504,82
F6.60.36	L1	CuNi/PVDF	FKM	IP65	1.504,82
F6.60.38	L0	INOX 316/PEEK	FKM	IP65	1.468,89
F6.60.40	L1	INOX 316/PEEK	FKM	IP65	1.504,82

Sensor de caudal electromagnético **BIDIRECCIONAL**.
 Alimentación 12-24 VDC. **VERSIÓN CIEGA**. Rango caudal: 0,15 - 8 m/s.



F6.63

R

Ref.	Longitud sensor	Material sensor	Juntas	Protección	€
F6.63.09	L0	INOX 316L/PVDF	EPDM	IP65	1.141,79
F6.63.10	L0	INOX 316L/PVDF	FKM	IP65	1.141,79
F6.63.11	L1	INOX 316L/PVDF	EPDM	IP65	1.172,33
F6.63.12	L1	INOX 316L/PVDF	FKM	IP65	1.172,33
F6.63.33	L0	CuNi/PVDF	EPDM	IP65	1.248,70
F6.63.34	L0	CuNi/PVDF	FKM	IP65	1.248,70
F6.63.35	L1	CuNi/PVDF	EPDM	IP65	1.279,25
F6.63.36	L1	CuNi/PVDF	FKM	IP65	1.279,25
F6.63.38	L0	INOX 316/PEEK	FKM	IP65	1.248,70
F6.63.40	L1	INOX 316/PEEK	FKM	IP65	1.279,25

Sensor de caudal electromagnético **MONODIRECCIONAL**.
 Alimentación 12-24 VDC. **VERSIÓN CIEGA**. Rango caudal: 0,15 - 8 m/s.



F6.61.01

R

Ref.	Material cuerpo	Protección	Longitud mm.	€
F6.61.01	INOX 304/PVDF/INOX 316L	IP65	615	2.894,12

Sensor de caudal electromagnético para tomas en carga.
 Alimentación 12-24 VDC. **VERSIÓN HOT TAP**.
 Rango caudal: 0,15 - 8 m/s.



F3.8X.H.0X

R

Ref.	Caudal	Material	Engranajes	Juntas	€
F3.81.H.01	10-100 l/h	PP	ECTFE	FKM	599,40
F3.81.H.02	10-100 l/h	ECTFE	ECTFE	FKM	881,96
F3.81.H.03	10-100 l/h	INOX 316 L	ECTFE	FKM	1.124,15
F3.82.H.01	25-150 l/h	PP	ECTFE	FKM	599,40
F3.82.H.02	25-150 l/h	ECTFE	ECTFE	FKM	881,96
F3.82.H.03	25-150 l/h	INOX 316 L	ECTFE	FKM	1.124,15

Sensor oval para caudales bajos. Versión especial con salida 4-20mA bajo pedido.
 Alimentación 12-24 VDC. Protección IP65.



ULF01.X.X

R

Ref.	Voltaje	Versión	Material	€
ULF01.H.0	5-24 VDC	HALL	POM-FKM	205,87
ULF01.H.2	5-24 VDC	HALL	ECTFE-FKM	508,58
ULF01.H.3	5-24 VDC	HALL	ECTFE-KALREZ	795,18
ULF01.R.0	-	REED	POM-FKM	224,02
ULF01.R.2	-	REED	ECTFE-FKM	478,32
ULF01.R.3	-	REED	ECTFE-KALREZ	748,76

Sensor para caudales bajos entre 1,5-100 l/h. Protección IP65.



ULF03.X.X

R

Ref.	Voltaje	Versión	Material	€
ULF03.H.0	5-24 VDC	HALL	POM-FKM	205,87
ULF03.H.2	5-24 VDC	HALL	ECTFE-FKM	508,58
ULF03.H.3	5-24 VDC	HALL	ECTFE-KALREZ	795,18
ULF03.R.0	-	REED	POM-FKM	224,02
ULF03.R.2	-	REED	ECTFE-FKM	478,32
ULF03.R.3	-	REED	ECTFE-KALREZ	748,76

Sensor para caudales bajos entre 6-250 l/h. Protección IP65.

Longitud L0 para diámetros de ø 20-110 mm. Longitud L1 para diámetros de 125-450 mm.
 El pedido estándar se compone de sensor + pantalla + accesorios de conexión al tubo. Disponemos de instrucciones de funcionamiento de los modelos.



pH200/ORP200

Ref.	Descripción	Cable (venta aparte)	Conexión	Instalación	R €
PH200C	Electrodo combinado pH/referencia	No necesario	5 metros cable	EG50P, EG75P, MK150200, MIFV20X05, MIMC20X05	169,97
PH222CD	Electrodo combinado pH/referencia doble toma tipo cartucho	CN653, CN653TC1	Twist-Lock (BNC)	EG50P, EG75P, MIFV20X05, MIMC20X05	210,17
PH223CD	Electrodo combinado pH/referencia doble toma tipo cartucho para accesorios FLS	CN653	Twist-Lock (BNC)	F3.SP2.4	243,06
PH222CDTC	Electrodo combinado pH/referencia doble toma tipo cartucho con Pt 1000	CN653	Twist-Lock (BNC)	F3.SP2.4	541,30
ORP200C	Electrodo combinado ORP/referencia	No necesario	5 metros cable	EG50P, EG75P, MK150200, MIFV20X05, MIMC20X05	228,44
ORP222CD	Electrodo combinado ORP/referencia doble toma tipo cartucho	CN653	Twist-Lock (BNC)	EG50P, EG75P, MIFV20X05, MIMC20X05	330,09
ORP223CD	Electrodo combinado de ORP/referencia doble toma tipo cartucho para accesorios FLS	CN653	Twist-Lock (BNC)	F3.SP2.4	364,66

Electrodo de pH / Electrodo de ORP.

Rango de funcionamiento: 0-14 pH / Rango de funcionamiento: ± 2000 Mv.

Cuerpo epóxico.



pH400/ORP400

Ref.	Descripción	Cable (venta aparte)	Conexión	Instalación	R €
PH431CD	Electrodo combinado de pH/referencia doble toma	No necesario	S7	GEG135	548,33
PH435CD	Electrodo combinado de pH/referencia doble toma para altas temperaturas	CE5S7	S7	GEG135, EG135SE	668,36
ORP431CD	Electrodo combinado de ORP/referencia de doble toma	No necesario	S7	GEG135	612,74

Electrodo de pH / Electrodo de ORP.

Rango de funcionamiento: 0-14 pH / Rango de funcionamiento: ± 1000 Mv.

Cuerpo de cristal.



ORP600/pH600

Ref.	Descripción	Cable (venta aparte)	Conexión	Instalación	R €
ORP660CD	Electrodo de superficie plana combinado de ORP con doble toma de C-PVC	CN653	Twist-Lock (BNC)	EG66P, MK660	568,38
ORP650CD	Electrodo de superficie plana combinado de ORP con doble toma de C-PVC	CN653 / CN653 TC1	Twist-Lock (BNC)	MIFV20X05, MIMC20X05	568,38
ORP655CD	Electrodo de superficie plana combinado de ORP con doble toma de C-PVC y gel de relleno presurizado	CN653	Twist-Lock (BNC)	WT675, WT675 TC1	596,69
ORP660CDDA	Electrodo combinado de pH/ORP de superficie plana con interrupción de bucle de tierra. Aplicaciones: presencia de corrientes parásitas	CN653	Twist-Lock (BNC)	EG66P, MK660	1.078,26
ORP650CDDA	Electrodo combinado de pH/ORP de superficie plana con interrupción de bucle de tierra. Aplicaciones: presencia de corrientes parásitas	CN653 / CN653 TC1	Twist-Lock (BNC)	MIFV20X05, MIMC20X05	1.046,61
PH660CD	Electrodo de pH superficie plana combinado doble toma de C-PVC	CN653	Twist-Lock (BNC)	EG66P, MK660	478,81
PH650CD	Electrodo de pH superficie plana combinado doble toma de C-PVC	CN653 / CN653 TC1	Twist-Lock (BNC)	MIFV20X05, MIMC20X05	478,81
PH655CD	Electrodo de pH superficie plana combinado, doble toma de C-PVC y con gel de relleno presurizado	CN653	Twist-Lock (BNC)	WT675, WT675 TC1	502,57
PH660CDHF	Electrodo de pH superficie plana combinado doble toma de C-PVC. Líquidos con HF (máx. 2%)	CN653	Twist-Lock (BNC)	EG66P, MK660	585,74
PH650CDHF	Electrodo de pH superficie plana combinado doble toma de C-PVC. Líquidos con HF (máx. 2%)	CN653 / CN653 TC1	Twist-Lock (BNC)	MIFV20X05, MIMC20X05	695,39
PH655CDHF	Electrodo de pH superficie plana combinado, doble toma de C-PVC y con gel de relleno presurizado. Líquidos con HF (máx. 2%)	CN653	Twist-Lock (BNC)	WT675, WT675 TC1	695,39
PH660CDDA	Electrodo combinado de pH de superficie plana con interrupción de bucle de tierra. Aplicaciones: presencia de corrientes parásitas	CN653	Twist-Lock (BNC)	EG66P, MK660	915,59
PH650CDDA	Electrodo combinado de pH de superficie plana con interrupción de bucle de tierra. Aplicaciones: presencia de corrientes parásitas	CN653 / CN653 TC1	Twist-Lock (BNC)	MIFV20X05, MIMC20X05	915,59
PH660CDLC	Electrodo de pH con superficie plana combinado y doble toma de C-PVC. Líquidos con baja conductividad (<100 ms)	CN653	Twist-Lock (BNC)	EG66P, MK660	517,19
PH650CDLC	Electrodo de pH con superficie plana combinado y doble toma de C-PVC. Líquidos con baja conductividad (<100 ms)	CN653 / CN653 TC1	Twist-Lock (BNC)	MIFV20X05, MIMC20X05	609,51
PH655CDLC	Electrodo de pH con superficie plana combinado, doble toma de C-PVC y con gel de relleno presurizado. Líquidos con baja conductividad (<100 ms)	CN653	Twist-Lock (BNC)	WT675, WT675 TC1	609,51

Electrodo de ORP / Electrodo de PH.

De superficie plana.

pH800

Ref.	Descripción	Aplicación / Rango operativo	Conexión	Instalación	R €
PH870CDTC	Electrodo pH Ryton doble unión con Pt1000	0-14 pH (0-12,3 pH sin Na + error)	5 metros	¾" NPT	781,46
PH870CDTCHM	Electrodo pH Ryton doble unión con Pt1000	0-14 pH (0-12,3 pH sin Na + error) Montaje horizontal	5 metros	¾" NPT	849,06
PH870CDTCLC	Electrodo pH Ryton doble unión con Pt1000	0-14 pH (0-12,3 pH sin Na + error) Baja conductividad (<100 µS)	5 metros	¾" NPT	832,15
PH870CDTCHF	Electrodo pH Ryton doble unión con Pt1000	0-14 pH (0-12,3 pH sin Na + error) Presencia de HF (max 2%)	5 metros	¾" NPT	882,86

Electrodo de pH.

De superficie plana.



C150/C200

Ref.	Descripción	Rango funcionamiento	Constante de celda	Conexión	Instalación	R €
C150.01TC	Sensor de conductividad en grafito con sensor de temperatura	0,1 µS a 2.000 µS	0,1 Cell	5 metros	EG50P, EG75P, MIFV20X05, MIMC20X05	320,45
C150.1TC	Sensor de conductividad en grafito con sensor de temperatura	1µS a 20.000 µS	1,0 Cell	5 metros	EG50P, EG75P, MIFV20X05, MIMC20X05, MK150200	320,45
C200.01TC	Sensor de conductividad en grafito con sensor de temperatura	0,1 µS a 2.000 µS	0,1 Cell	5 metros	EG50P, EG75P, MIFV20X05, MIMC20X05	409,87
C200.1TC	Sensor de conductividad en grafito con sensor de temperatura	1 µS a 20.000 µS	1,0 Cell	5 metros	EG50P, EG75P, MIFV20X05, MIMC20X05	409,87
C200.10TC	Sensor de conductividad en grafito con sensor de temperatura	10 µS a 200.000 µS	10,0 Cell	5 metros	EG50P, EG75P, MIFV20X05, MIMC20X05	409,87

Sensor de conductividad.

De cuerpo epóxico.



C6.30

Ref.	Descripción	Rango funcionamiento	Conexión	Instalación	R €
C6.30.01	Transmisor de conductividad inductivo con sensor de temperatura incluido	0-10 mS	3 metros	Rosca macho 1 ½" NPT	1.361,51
C6.30.02	Transmisor de conductividad inductivo con sensor de temperatura incluido	0-100 mS	3 metros	Rosca macho 1 ½" NPT	1.361,51
C6.30.03	Transmisor de conductividad inductivo con sensor de temperatura incluido	0-1.000 mS	3 metros	Rosca macho 1 ½" NPT	1.361,51

Transmisor de conductividad inductivo

Cuerpo en C-PVC.



C100/C300

Ref.	Descripción	Rango funcionamiento	Constante de celda	Conexión	Instalación	R €
C100.01TC	Sensor de PP con electrodo de conductividad en acero inox con sensor de temperatura	0,1 µS a 2.000 µS	0,1 Cell	Conector 4 clavijas	Rosca macho 3/4" BSP	286,91
C100.02TC	Sensor de PP con electrodo de conductividad en acero inox con sensor de temperatura	0,2 µS a 4.000 µS	0,2 Cell	Conector 4 clavijas	Rosca macho 3/4" BSP	286,91
C100.1TC	Sensor de PP con electrodo de conductividad en acero inox con sensor de temperatura	1 µS a 20.000 µS	1,0 Cell	Conector 4 clavijas	Rosca macho 3/4" BSP	286,91
C300.001TC	Sensor con cuerpo y electrodos de conductividad en acero inox.	0,055 µS a 200 µS	0,01 Cell	3 metros	EG12 SS	568,21
C300.001TCCK	Sensor con cuerpo y electrodo de conductividad en acero inox con certificado de constante de Cell	0,055 µS a 200 µS	0,01 Cell	3 metros	EG12 SS	724,00
C300.10TC	Sensor con cuerpo y electrodos de conductividad en acero inox.	10 µS a 200.000 µS	10,0 Cell	3 metros	EG12 SS	568,21

Sensor de conductividad.

C100 cuerpo en PP y C300 cuerpo en inox.



d x Rh	Ref.	DN	Material	Longitud sensor	Juntas	€
20	TFIV20B	15	PVC-U	L0	EPDM	82,83
25	TFIV25B	20	PVC-U	L0	EPDM	82,83
32	TFIV32B	25	PVC-U	L0	EPDM	104,10
40	TFIV40B	32	PVC-U	L0	EPDM	104,10
50	TFIV50B	40	PVC-U	L0	EPDM	115,95
20	TFIV20D	15	PVC-U	L0	FKM	82,83
25	TFIV25D	20	PVC-U	L0	FKM	82,83
32	TFIV32D	25	PVC-U	L0	FKM	104,10
40	TFIV40D	32	PVC-U	L0	FKM	104,10
50	TFIV50D	40	PVC-U	L0	FKM	115,95
20	TFIM20B	15	PP-H	L0	EPDM	95,84
25	TFIM25B	20	PP-H	L0	EPDM	95,84
32	TFIM32B	25	PP-H	L0	EPDM	123,04
40	TFIM40B	32	PP-H	L0	EPDM	123,04
50	TFIM50B	40	PP-H	L0	EPDM	140,79
20	TFIM20D	15	PP-H	L0	FKM	95,84
25	TFIM25D	20	PP-H	L0	FKM	95,84
32	TFIM32D	25	PP-H	L0	FKM	123,04
40	TFIM40D	32	PP-H	L0	FKM	123,04
50	TFIM50D	40	PP-H	L0	FKM	140,79

d x Rh	Ref.	DN	Material	Longitud sensor	Juntas	€
20	TFIF20B	15	PVDF	L0	EPDM	154,99
25	TFIF25B	20	PVDF	L0	EPDM	154,99
32	TFIF32B	25	PVDF	L0	EPDM	165,65
40	TFIF40B	32	PVDF	L0	EPDM	165,65
50	TFIF50B	40	PVDF	L0	EPDM	186,93
20	TFIF20D	15	PVDF	L0	FKM	154,99
25	TFIF25D	20	PVDF	L0	FKM	154,99
32	TFIF32D	25	PVDF	L0	FKM	165,65
40	TFIF40D	32	PVDF	L0	FKM	165,65
50	TFIF50D	40	PVDF	L0	FKM	186,93
20	TFIV20BE	15	PVC-U+PE	L0	EPDM	82,83
25	TFIV25BE	20	PVC-U+PE	L0	EPDM	82,83
32	TFIV32BE	25	PVC-U+PE	L0	EPDM	104,10
40	TFIV40BE	32	PVC-U+PE	L0	EPDM	104,10
50	TFIV50BE	40	PVC-U+PE	L0	EPDM	115,95
20	TFIV20DE	15	PVC-U+PE	L0	FKM	82,83
25	TFIV25DE	20	PVC-U+PE	L0	FKM	82,83
32	TFIV32DE	25	PVC-U+PE	L0	FKM	104,10
40	TFIV40DE	32	PVC-U+PE	L0	FKM	104,10
50	TFIV50DE	40	PVC-U+PE	L0	FKM	115,95
1/2"	TFFX20	15	INOX316	L0		239,00
3/4"	TFFX25	20	INOX316	L0		239,00
1"	TFFX32	25	INOX316	L0		239,00
1 1/4"	TFFX40	32	INOX316	L0		259,11

Te Otras conexiones disponibles bajo pedido



Ref.	Rango	Material	€
HF6004	0-400 mbarg	PVDF, PUR, FKM cerámica	1.081,49
HF6010	0-1.000 mbarg	PVDF, PUR, FKM cerámica	1.081,49
HF6100	0-10 barg	PVDF, PUR, FKM cerámica	1.081,49
HF6160	0-16 barg	PVDF, PUR, FKM cerámica	1.081,49

Transmisor de presión y nivel de profundidad



INDUSTRIA

Medición

Accesorios de instalación y recambios



d	Ref.	DN	Material	Longitud sensor	R	€
50-225	WAIXLO	40-200	Inox 316L	L0		127,79
250-600	WAIXL1	225-600	Inox 316L	L1		144,33

Inserto para tubos metálicos.



Ref.	Descripción	R	€
WAIXHP	Kit inserto adaptación Inox 316 para F3.20.X.01		300,97

Accesorio de instalación para sensor **F3.20.X.01**.

De Ø 50 a Ø 225 (DN40 A DN200).



Ref.	Cuerpo	DN	R	€
WAIXHT	Inox 316L	350-400		127,79

Adaptador para toma en carga para sensores.



TM

d	Ref.	DN	Cuerpo	Conexión	R	€
20	TMIV20MF	15	PVC-U	H encolar		44,96
25	TMIV25MF	20	PVC-U	H encolar		47,31
32	TMIV32MF	25	PVC-U	H encolar		47,31
40	TMIV40MF	32	PVC-U	H encolar		49,69
50	TMIV50MF	40	PVC-U	H encolar		49,69
1¼"	TMFODN23	23	Latón	M roscar		192,86

Te para minisensor **F3.10.H.XX**.



d	Ref.	DN	Cuerpo	Longitud sensor	Juntas	R	€
63	SVIC063BVC	50	PVC-U	L0	EPDM		93,69
75	SVIC075BVC	65	PVC-U	L0	EPDM		123,52
90	SVIC090BVC	80	PVC-U	L0	EPDM		123,52
110	SVIC110BVC	100	PVC-U	L0	EPDM		134,16
125	SVIC125BVC	110	PVC-U	L1	EPDM		142,70
140	SVIC140BVC	125	PVC-U	L1	EPDM		149,07
160	SVIC160BVC	150	PVC-U	L1	EPDM		186,34
200	SVIC200BVC	180	PVC-U	L1	EPDM		186,34
225	SVIC225BVC	200	PVC-U	L1	EPDM		193,80
110	SVIC110DVC	100	PVC-U	L0	FKM		134,16
125	SVIC125DVC	110	PVC-U	L1	FKM		142,70
250	SMIC250IVC	225	PP	L0	NBR		241,36
280	SMIC280IVC	250	PP	L1	NBR		269,74
315	SMIC315IVC	300	PP	L1	NBR		269,74

Collarín para tubos de PVC-U y C-PVC.

Inserto en C-PVC.



d	Ref.	DN	Cuerpo	Longitud sensor	Juntas	R	€
63	SVIC063BME	50	PVC-U	L0	EPDM		93,69
75	SVIC075BME	65	PVC-U	L0	EPDM		123,52
90	SVIC090BME	80	PVC-U	L0	EPDM		123,52
110	SVIC110BME	100	PVC-U	L0	EPDM		134,16
125	SVIC125BME	110	PVC-U	L1	EPDM		142,70
140	SVIC140BME	125	PVC-U	L1	EPDM		149,07
160	SVIC160BME	150	PVC-U	L1	EPDM		186,34
200	SVIC200BME	180	PVC-U	L1	EPDM		186,34
225	SVIC225BME	200	PVC-U	L1	EPDM		193,80
110	SVIC110DME	100	PVC-U	L0	FKM		134,16
125	SVIC125DME	110	PVC-U	L1	FKM		142,70
250	SMIC250IME	225	PP	L0	NBR		241,36
280	SMIC280IME	250	PP	L1	NBR		269,74
315	SMIC315IME	300	PP	L1	NBR		269,74

Collarín para tubos de PP-H y PE.

Inserto en C-PVC.



R

d	Ref.	DN	Cuerpo	Longitud sensor	Juntas	€
63	SVIF063BF	50	PVC-U	L0	EPDM	121,39
75	SVIF075BF	65	PVC-U	L0	EPDM	160,78
90	SVIF090BF	80	PVC-U	L0	EPDM	160,78
110	SVIF110BF	100	PVC-U	L0	EPDM	174,63

Collarín **para tubos de PVDF.**

Inserto en PVDF.



R

d	Ref.	DN	Cuerpo	Longitud sensor	Juntas	€
63	SVIF063BF	50	PVC-U	L0	FKM	121,39
75	SVIF075BF	65	PVC-U	L0	FKM	160,78
90	SVIF090BF	80	PVC-U	L0	FKM	160,78
110	SVIF110BF	100	PVC-U	L0	FKM	174,63

Collarín **para tubos de PVDF.**

Inserto en PVDF.



R

Ref.	DN	Cuerpo	Longitud sensor	Tolerancia	€
SZIC080I	80	Acero+inox	L0	88-104	152,64
SZIC100I	100	Acero+inox	L0	112-126	157,36
SZIC125I	125	Acero+inox	L0	140-154	201,13
SZIC150I	150	Acero+inox	L0	168-184	212,95
SZIC200I	200	Acero+inox	L1	218-244	222,43
SZIC250I	250	Acero+inox	L1	272-295	235,43
SZIC300I	300	Acero+inox	L1	322-354	249,63
SZIC350I	350	Acero+inox	L1	356-414	270,93
SZIC400I	400	Acero+inox	L1	406-472	307,62
SZIC450I	450	Acero+inox	L1	457-534	373,87

Collarín metálico.

Junta en NBR. Inserto en C-PVC.



R

Ref.	DN	Cuerpo	Longitud sensor	Tolerancia	€
SZIC080IHT	80	Acero+inox	L0	88-104	152,64
SZIC100IHT	100	Acero+inox	L0	112-126	157,36
SZIC125IHT	125	Acero+inox	L0	140-154	201,13
SZIC150IHT	150	Acero+inox	L0	168-184	212,95
SZIC200IHT	200	Acero+inox	L1	218-244	222,43
SZIC250IHT	250	Acero+inox	L1	272-295	235,43
SZIC300IHT	300	Acero+inox	L1	322-354	249,63
SZIC350IHT	350	Acero+inox	L1	356-414	270,93
SZIC400IHT	400	Acero+inox	L1	406-472	307,62
SZIC450IHT	450	Acero+inox	L1	457-534	373,87

Collarín metálico **con toma en carga.**

Salida 2" rosca hembra. Junta en NBR.

Longitud L0 para diámetros de ø 20-110 mm. Longitud L1 para diámetros de 125-450 mm.

Adaptadores para instalación en línea, sumergibles e instalación Wet-Tap.

R

	Ref.	Cuerpo	Descripción	Para electrodos	€
	EG12SS	Inox	Prensaestopas de electrodos macho 1/2"	C300	146,67
	TCONIV32E	PVC-U	Accesorio en T ø 32 DN25	C150-200	85,21
	TCONIV40E	PVC-U	Accesorio en T ø 40 DN32	C150-200	89,47
	TCONIV50E	PVC-U	Accesorio en T ø 50 DN40	C150-200	93,95
	TCONIC32E	C-PVC	Accesorio en T ø 32 DN25	C150-200	94,60
	TCONIC40E	C-PVC	Accesorio en T ø 40 DN32	C150-200	99,34
	TCONIC50E	C-PVC	Accesorio en T ø 50 DN40	C150-200	104,30
	TPHIV32E	PVC-U	Accesorio en T ø 32 DN25	PH/ORP200 (NO p/PH223CD,ORP223CD)	85,20
	TPHIV40E	PVC-U	Accesorio en T ø 40 DN32	PH/ORP200 (NO p/PH223CD,ORP223CD)	66,92
	TPHIV50E	PVC-U	Accesorio en T ø 50 DN40	PH/ORP200 (NO p/PH223CD,ORP223CD)	93,94
	TPHIC32E	C-PVC	Accesorio en T ø 32 DN25	PH/ORP200 (NO p/PH223CD,ORP223CD)	75,68
	TPHIC40E	C-PVC	Accesorio en T ø 40 DN32	PH/ORP200 (NO p/PH223CD,ORP223CD)	79,48
	TPHIC50E	C-PVC	Accesorio en T ø 50 DN40	PH/ORP200 (NO p/PH223CD,ORP223CD)	83,43
	TPHIC32C	C-PVC	Accesorio en T ø 32 DN25	PH660-ORP660	94,62
	TPHIC40C	C-PVC	Accesorio en T ø 40 DN32	PH660-ORP660	98,40
	TPHIC50C	C-PVC	Accesorio en T ø 50 DN40	PH660-ORP660	102,37
	EG66P	C-PVC	Prensaestopas de electrodos macho 3/4"	PH660-ORP660	54,35
	MK660	C-PVC	Kit de instalación (adaptador + tapón amarillo) para accesorios FLS hasta DN100 (4")	PH660-ORP660	27,95
	MK150200	C-PVC	Kit de instalación (EG50P + adaptador + tapón amarillo) para accesorios FLS hasta DN100 (4")	PH200C, ORP200C, C150.1, C150.01TC	59,00
	GEG135SE	PP	Prensaestopas para electrodo PG13.5 con protección de cabeza de electrodo 1 1/4" G.M.	PH430CD, ORP430CD, PH435CD	227,73
	F3.SP2.4	PVC-U	Tapón de electrodo color amarillo para accesorios FLS hasta DN100 (4")	PH223CD, ORP223CD	18,30
	GEG135	PVC-U	Prensaestopas para electrodo PG13.5 o cuerpo de 12 mm y 1 1/2" G.M.	PH-ORP400	21,75
	EG50P	PP	Prensaestopas de electrodo macho 1/2"	PH-ORP200 (NO para PH223CD, ORP223CD), C150-200, T970278, T970196	29,51
	EG75P	PP	Prensaestopas de electrodo macho 3/4"	PH-ORP200 (NO para PH223CD, ORP223CD), 0-200, T970278, T970196	29,51
	EG135FS	PVDF/FKM	Prensaestopas corto p/electrodo PG13.5 1/2"	PH-ORP430, PH435CD	59,81
	EG135FL	PVDF/FKM	Prensaestopas largo p/electrodo PG13.5 1/2"	PH-ORP430, PH435CD	65,76

Adaptadores para instalación en inmersión.

R

	Ref.	Cuerpo	Descripción	Para electrodos	€
	MIFV20X05	PVC-U	Doble toma 20 x 1/2" (tubería suministrada por el cliente)	PH200C-ORP200C (con EG50P), PH222CD ORP222CD (con CN653), (GEG135), PH650 ORP650 (CON CN653), C150-200 (CON EG50P)	3,13
	MIMC20X05	C-PVC	Doble toma 20 x 1/2" (tubería suministrada por el cliente)	PH200C-ORP200C (con EG50P), PH222CD ORP222CD (con CN653), (GEG135), PH650 ORP650 (CON CN653), C150-200 (CON EG50P)	13,98

Adaptadores para toma en carga u horizontal.

R

	Ref.	Cuerpo	Descripción	Para electrodos	€
	WT675	C-PVC	Prensaestopa de electrodo para instalación con toma en carga: inserción máxima 300 mm (12")	PH655-ORP655	665,37
	WT675TC1	C-PVC/SS	Prensaestopa de electrodo para instalación con toma en carga: inserción máxima 300 mm (12")	PH655-ORP655	993,61

Recambios para monitor M9.00.

R

Ref.	Descripción	€
M9.SP4.1	Prensaestopas de cable completo PG11 (2 juntas tóricas y capuchón)	6,67
M9.LN1	Tuerca de bloqueo de plástico para M9.02	33,58
M9.SN1	2 Tornillos de fijación de plástico para instalación en panel de todos los monitores FLS (excepto para M9.02)	33,58
M9.SP7	Recambio de batería 3,6 voltios (2,4 Ah). Batería de litio cloruro de tionilo (sólo para M9.20)	116,78
M9.KUSB	Cable USB para productos FLS, 1,5 metros de longitud	17,24

Recambios para sensor de caudal de paletas F3.00.

R

Ref.	Descripción	€
F3.SP1	Enchufe de cable de 4 clavijas según DIN 43650	38,08
F3.SP2.1	Tapón negro para sensor versión HALL	18,30
F3.SP2.2	Tapón rojo para sensor versión COIL	18,30
F3.SP2.4	Tapón amarillo para sensor versión PLC	18,30
F3.SP2.6	Tapón en inox AISI 316 para sensor en inox versión HALL y COIL	41,14
F3.SP3.1	Juntas tóricas para cuerpo del sensor en EPDM	3,07
F3.SP3.2	Juntas tóricas para cuerpo del sensor en FKM	4,58
F3.SP4.2	Kit rotor. Rotor en ECTFE (Halar®) con cojinetes y eje en cerámica mecanizada	153,85
F3.SP4.3	Kit rotor. Rotor en ECTFE (Halar®) con eje en acero inox	94,44
F3.SP5.1	Toma de sensor en C-PVC	42,65
F3.SP5.2	Toma de sensor en PVDF	60,52
F3.SP5.3	Toma de sensor en acero inox	22,84
F3.SP6	Cable eléctrico (precio por metro), 22AWG, 3 cond.	3,41

Recambios para sensor de caudal de paletas para altas presiones F3.20.

R

Ref.	Descripción	€
F3.SP4.3	Kit rotor. Rotor en ECTFE (Halar®) con eje en acero inox	94,44
F3.SP8	Kit de juntas y tornillos. Tornillos en acero inox y junta en grafito	39,70

Recambios para transmisor de caudal de paletas F6.30.

R

Ref.	Descripción	€
F6.KC1	Kit de montaje compacto. Adaptador de plástico con capuchón compacto y tuerca de bloqueo	97,58
M9.SP4.1	Prensaestopas de cable completo PG11 (2 juntas tóricas y capuchón)	6,67
F3.SP3.1	Juntas tóricas para cuerpo del sensor en EPDM	3,07
F3.SP3.2	Juntas tóricas para cuerpo del sensor en FKM	4,58
F6.30.SP1S	Dispositivo electrónico con salida 4-20 mA y salida de impulsos de frecuencia/volumen para sensor de caudal de paletas	902,98
M9.KUSB	Cable USB para productos FLS, 1,5 metros de longitud	17,24

Recambios para minisensor de caudal de paletas F3.10.

R

Ref.	Descripción	€
F3.SP2.7	Tapa de sensor gris	7,19
F3.SP3.3	Juntas tóricas para cuerpo del sensor en EPDM	3,13
F3.SP3.4	Juntas tóricas para cuerpo del sensor en FKM	4,64
F3.SP11	Kit rotor. Rotor de PVC con eje en AISI 316L	48,03
M9.KUSB	Cable USB para productos FLS, 1,5 metros de longitud	17,24

Recambios para sensor de caudal de paletas interruptor de caudal (Batch Controller) F3.05.

R

Ref.	Descripción	€
F3.SP1	Enchufe de cable de 4 clavijas según DIN 43650	38,08
F3.SP2.1	Tapón negro para sensor versión HALL	18,30
F3.SP3.1	Juntas tóricas para cuerpo del sensor en EPDM	3,07
F3.SP3.2	Juntas tóricas para cuerpo del sensor en FKM	4,58
F3.SP4.2	Kit rotor. Rotor en ECTFE (Halar®) con cojinetes y eje en cerámica mecanizada	153,85
F3.SP5.1	Toma de sensor en C-PVC	42,65
F3.SP5.2	Toma de sensor en PVDF	60,52
F3.SP5.3	Toma de sensor en acero inox	22,84

Recambios para sensor de caudal electromagnético para tomas en carga F6.61.

R

Ref.	Descripción	€
F6.KC1	Kit de montaje compacto. Adaptador de plástico con capuchón compacto y tuerca de bloqueo	97,58
M9.SP4.1	Prensaestopas de cable completo PG11 (2 juntas tóricas y capuchón)	6,67
F1.SP3	Válvula de aislamiento esférica de latón 2"	121,36
F1.SP5	Válvula de aislamiento esférica de latón 1¼"	121,36
F1.SP6	Reducción roscada macho-hembra 2"-1¼" en acero cincado	12,77
F1.SP7	Reducción roscada macho(NPT)-hembra 2"-1¼" en acero cincado	12,77
F6.60M.SP1S	Dispositivo electrónico de medición magnética con salida 4-20 mA y salida de impulsos de frecuencia/volumen.	902,98
F3.61M.SP01	Sensor de caudal de medidor electromagnético para inserción con toma en carga. Cuerpo en inox 304/PVDF	2.418,14
M9.KUSB	Cable USB para productos FLS, 1,5 metros de longitud	17,24



Recambios para sensor de caudal electromagnético F6.60

R

Ref.	Descripción	€
F6.KC1	Kit de montaje compacto. Adaptador de plástico con capuchón compacto y tuerca de bloqueo	97,58
M9.SP4.1	Prensaestopas de cable completo PG11 (2 juntas tóricas y capuchón)	6,67
F3.SP3.1	Juntas tóricas para cuerpo del sensor en EPDM	3,07
F3.SP3.2	Juntas tóricas para cuerpo del sensor en FKM	4,58
F6.60.SP1S	Dispositivo electrónico de medición magnética con salida 4-20 mA y salida de impulsos de frec./volum. para sensor bidireccional	902,98
F3.60M.SP09	Sensor de caudal bidireccional p/medidor electromagn. Cuerpo en inox 316L/PVDF. Juntas tóricas en EPDM. Long. L0	817,52
F3.60M.SP10	Sensor de caudal bidireccional p/medidor electromagn. Cuerpo en inox 316L/PVDF. Juntas tóricas en FKM. Long. L0	817,42
F3.60M.SP11	Sensor de caudal bidireccional p/medidor electromagn. Cuerpo en inox 316L/PVDF. Juntas tóricas en EPDM. Long. L1	871,32
F3.60M.SP12	Sensor de caudal bidireccional p/medidor electromagn. Cuerpo en inox 316L/PVDF. Juntas tóricas en FKM. Long. L1	871,32
F3.60M.SP13	Sensor de caudal bidireccional p/medidor electromagn. Cuerpo en CuNi/PVDF. Juntas tóricas en EPDM. Long. L0	943,20
F3.60M.SP14	Sensor de caudal bidireccional p/medidor electromagn. Cuerpo en CuNi/PVDF. Juntas tóricas en FKM. Long. L0	943,20
F3.60M.SP15	Sensor de caudal bidireccional p/medidor electromagn. Cuerpo en CuNi/PVDF. Juntas tóricas en EPDM. Long. L1	997,09
F3.60M.SP16	Sensor de caudal bidireccional p/medidor electromagn. Cuerpo en CuNi/PVDF. Juntas tóricas en FKM. Long. L1	997,09
F3.60M.SP17	Sensor de caudal bidireccional p/medidor electromagn. Cuerpo en inox316L/PEEK. Juntas tóricas en FKM. Long. L0	943,20
F3.60M.SP18	Sensor de caudal bidireccional p/medidor electromagn. Cuerpo en inox316L/PEEK. Juntas tóricas en FKM. Long. L1	997,09
M9.KUSB	Cable USB para productos FLS, 1,5 metros de longitud	17,24





Recambios para monitor M9.00.

R

Ref.	Descripción	€
 F6.KC1	Kit de montaje compacto. Adaptador de plástico con capuchón compacto y tuerca de bloqueo (sólo para monitor M9.02)	97,58
 M9.KW1	Kit de montaje mural. Caja plástica de 144 x 144 mm para instalación mural de todos los monitores de montaje en panel	142,80
 M9.KW2	Kit de montaje mural con alimentación. Caja plástica de 144 x 144 mm para instalación mural de todos los monitores de montaje en panel y fuente de alimentación de 110/230 VAC a 24DC incluida	277,65
M9.KUSB	Cable USB para productos FLS 1,5 metros de longitud	17,24



Recambios para electrodos de pH/ORP

R

	Ref.	Descripción	€
	CN653	Montaje cable universal de 5 metros. Para electrodos: PH222CD, OPR222CD, ORP223CD, PH-ORP600	193,72
	CN65310M	Montaje cable universal de 10 metros. Para electrodos: PH222CD, OPR222CD, ORP223CD, PH-ORP600	239,41
	CN65315M	Montaje cable universal de 15 metros. Para electrodos: PH222CD, OPR222CD, ORP223CD, PH-ORP600	285,08
	CN653TC1	Montaje de cable sumergible de 5 metros con compensación de temperatura. Para electrodos PH222CD, PH223CD, PH650CD, PH650CDHF, PH650CDDA, PH650CDLC	542,80
	CE5S7	Montaje cable de 5 metros. Para electrodos: PH435CD, PH430CD, ORP430CD	146,20
	CE10S7	Montaje cable de 10 metros. Para electrodos: PH435CD, PH430CD, ORP430CD	173,62
	CE15S7	Montaje cable de 15 metros. Para electrodos: PH435CD, PH430CD, ORP430CD	201,03
	B104	Solución tampón pH 4,01	49,33
	B107	Solución tampón pH 7,00	49,33
	B110	Solución tampón pH 10,00	49,33
	B3KCL	Solución tampón pH solución 3KCl	58,91
	B475	Solución tampón ORP 475 mV	49,33

Recambios para sensores de conductividad.

R

	Ref.	Descripción	€
	T970278	Sensor de temperatura PT100 con dos cables (5 metros) y cuerpo epóxico **	137,06
	T970196	Sensor de temperatura PT100 con dos cables (5 metros) y cuerpo epóxico ** (sin metal ni contacto)	347,23
	B0018	Solución tampón de conductividad para calibración de baja conductividad (18 microsiemens)	82,24
	B1417	Solución tampón de conductividad para calibración de conductividad (1.417 microsiemens)	82,24

** +5 € / metro cable

Tubo y accesorios
Válvulas manuales
Válvulas actuadas
Válvulas de control de presión

Sistema PP-H Socket

INDUSTRIA





Sistema PP-H Socket





INDUSTRIA

Sistema PP-H Socket

Tubo y accesorios

**T1**

d	Ref.	PN	Longitud barras	€/m.
20	PIPEM11020	10	5 m.	2,24
25	PIPEM11025	10	5 m.	3,15
32	PIPEM11032	10	5 m.	4,42
40	PIPEM11040	10	5 m.	5,72
50	PIPEM11050	10	5 m.	8,52
63	PIPEM11063	10	5 m.	13,44
75	PIPEM11075	10	5 m.	19,00
90	PIPEM11090	10	5 m.	27,03
110	PIPEM11110	10	5 m.	40,07
125	PIPEM11125	10	5 m.	52,82
140	PIPEM11140	10	5 m.	66,43
160	PIPEM11160	10	5 m.	84,63
180	PIPEM11180	10	5 m.	115,12
200	PIPEM11200	10	5 m.	139,69
225	PIPEM11225	10	5 m.	177,50
250	PIPEM11250	10	5 m.	225,84
280	PIPEM11280	10	5 m.	272,40
315	PIPEM11315	10	5 m.	351,50
355	PIPEM11355	10	5 m.	533,14
400	PIPEM11400	10	5 m.	672,49
450	PIPEM11450	10	5 m.	932,31
500	PIPEM11500	10	5 m.	1.149,99

Tubo PP-H (100) SDR11 (PN10). También disponible en PN6 hasta Ø800. Precios: consultar
 Para soldar socket y a testa. Para otros diámetros consultar disponibilidad.

**T****TIM**

d	Ref.	Pack	€
20	TIM020	10	3,11
25	TIM025	10	3,43
32	TIM032	10	4,00
40	TIM040	5	5,14
50	TIM050	5	9,18
63	TIM063	2	11,73
75	TIM075	-	27,19
90	TIM090	-	43,90
110	TIM110	-	55,71

Te a 90°.
 H-H-H para fusión socket.

**GIM****T**

d	Ref.	Pack	€
20	GIM020	10	2,64
25	GIM025	10	3,11
32	GIM032	10	3,76
40	GIM040	5	4,78
50	GIM050	5	8,80
63	GIM063	2	11,44
75	GIM075	-	23,79
90	GIM090	-	29,27
110	GIM110	-	43,90

Codo 90°.
 H-H para fusión socket.

**HIM****T**

d	Ref.	Pack	€
20	HIM020	10	3,76
25	HIM025	10	4,00
32	HIM032	10	4,94
40	HIM040	5	6,84
50	HIM050	5	8,80
63	HIM063	2	11,73
75	HIM075	-	27,19
90	HIM090	-	37,52
110	HIM110	-	54,87

Codo 45°.
 H-H para fusión socket.

**MIM****T**

d	Ref.	Pack	€
20	MIM020	10	1,81
25	MIM025	10	2,07
32	MIM032	10	2,39
40	MIM040	5	2,88
50	MIM050	5	5,50
63	MIM063	2	8,36
75	MIM075	-	11,63
90	MIM090	-	16,62
110	MIM110	-	26,08

Manguito.
 H-H para fusión socket.



MIMM

T

d x Rh	Ref.	Pack	€
20 x 1/2"	MIMM020012	10	3,53
25 x 3/4"	MIMM025034	10	4,48
32 x 1"	MIMM032100	10	5,71
40 x 1 1/4"	MIMM040114	5	6,84
50 x 1 1/2"	MIMM050112	5	11,24
63 x 2"	MIMM063200	2	14,23

Manguito mixto reforzado.
 H-H para fusión socket-roscar.



RIM

T

dm x dh	Ref.	Pack	€
25 x 20	RIM025020	10	2,56
32 x 20	RIM032020	10	3,11
32 x 25	RIM032025	10	3,11
40 x 25	RIM040025	10	3,68
40 x 32	RIM040032	10	3,68
50 x 32	RIM050032	5	4,78
50 x 40	RIM050040	5	4,67
63 x 32	RIM063032	5	5,57
63 x 50	RIM063050	5	5,71
75 x 50	RIM075050	-	10,21
75 x 63	RIM075063	-	10,21
90 x 63	RIM090063	-	14,23
90 x 75	RIM090075	-	14,00
110 x 63	RIM110063	-	19,52
110 x 90	RIM110090	-	20,15

Reducción cónica.
 M-H para fusión socket.



GRAM

T

d	Ref.	Pack	€
3/4"	GRAM034	10	5,50
1"	GRAM100	10	5,97
1 1/4"	GRAM114	10	7,47
1 1/2"	GRAM112	5	8,63
3"	GRAM300	-	36,61

Manguito portabridas estriado ANSI 150 lbs.
 H para fusión socket.



QRNM

T

d	Ref.	Pack	€
20	QRNM020	10	4,42
25	QRNM025	10	4,60
32	QRNM032	10	4,99
40	QRNM040	5	6,15
50	QRNM050	5	7,19
63	QRNM063	2	8,92
75	QRNM075	-	19,32
90	QRNM090	-	30,50
110	QRNM110	-	42,21

Manguito portabridas estriado.
 H para fusión socket.



ODC

B1

d	Ref.	DN	€
20	ODC020	15	4,27
25	ODC025	20	5,08
32	ODC032	25	5,88
40	ODC040	32	7,20
50	ODC050	40	9,30
63	ODC063	50	10,35
75	ODC075	65	15,42
90	ODC090	80	17,03
110	ODC110	100	23,39

Brida loca.
 UNI 2223 PN10.
 En C-PVC para manguito portabridas.



ODB

T1

d	Ref.	DN	€
20	ODB020	15	7,15
25	ODB025	20	7,86
32	ODB032	25	10,13
40	ODB040	32	12,28
50	ODB050	40	14,36
63	ODB063	50	17,85
75	ODB075	65	19,73
90	ODB090	80	23,50
**125	ODB125	100	28,36

Brida loca.

En PP con alma de acero.

PN10. Para manguito portabridas.

Versión ANSI 150 lbs (ver OAB página 370)

Más diámetros en página 370

** Para usar con portabridas QRNM110



CIM

T

d	Ref.	Pack	€
20	CIM020	10	2,39
25	CIM025	10	2,39
32	CIM032	10	2,96
40	CIM040	5	3,50
50	CIM050	5	5,01
63	CIM063	2	6,46
75	CIM075	-	11,83
90	CIM090	-	13,71
110	CIM110	-	18,95

Tapón.

H para fusión socket.



AIM

T

d x P1 x P2	Ref.	Pack	€
20 x 22 x 20	AIM020022020	10	2,70
25 x 27 x 25	AIM025027025	10	3,43
32 x 32 x 30	AIM032032030	10	4,18
40 x 42 x 40	AIM040042040	5	7,24
50 x 52 x 50	AIM050052050	5	9,02
63 x 64 x 60	AIM063064060	5	10,03

Espiga.

M para fusión socket.



BIGM

T

d	Ref. EPDM	Pack	€ EPDM	€ FKM
20	BIGM020E	10	10,34	12,00
25	BIGM025E	10	11,44	13,13
32	BIGM032E	10	13,13	15,54
40	BIGM040E	2	16,62	20,82
50	BIGM050E	2	23,74	29,27
63	BIGM063E	2	33,87	40,35

Unión 3 piezas.

H-H para fusión socket.

Código en FKM termina en "F" en lugar de "E"



BIFGM

T

d x Rh	Ref. EPDM	Pack	€ EPDM	€ FKM
20 x 1/2"	BIFGM020012E	10	15,54	18,19
25 x 3/4"	BIFGM025034E	10	17,10	19,59
32 x 1"	BIFGM032100E	10	17,91	21,39
40 x 1 1/4"	BIFGM040114E	2	27,95	35,54
50 x 1 1/2"	BIFGM050112E	2	40,89	50,72
63 x 2"	BIFGM063200E	2	46,96	55,71

Unión 3 piezas mixto.

H-H para fusión socket-rosocar.

Código en FKM termina en "F" en lugar de "E"



BIFOM

T

d x Rh	Ref.	Pack	€ EPDM
20 x 1/2"	BIFOM020012E	40	18,22
25 x 3/4"	BIFOM025034E	16	22,20
32 x 1"	BIFOM032100E	10	27,77
40 x 1 1/4"	BIFOM040114E	8	34,24
50 x 1 1/2"	BIFOM050112E	4	44,22
63 x 2"	BIFOM063200E	-	57,42

Unión 3 piezas mixto PP-H / latón.

Junta en EPDM.

H-H para fusión socket-rosocar latón.



BIROM

d x Rm	Ref.	Pack	€ EPDM	T € FKM
20 x 1/2"	BIROM020012E	35	20,51	
25 x 3/4"	BIROM025034E	15	24,78	
32 x 1"	BIROM032100E	8	31,83	
40 x 1 1/4"	BIROM040114E	8	42,01	
50 x 1 1/2"	BIROM050112E	4	51,73	
63 x 2"	BIROM063200E	-	66,70	

Unión 3 piezas mixto PP-H / latón.
Junta en EPDM.
H-M para fusión socket-rosocar latón.



BIFXM

d x Rh	Ref. EPDM	Pack	€ EPDM	T € FKM
20 x 1/2"	BIFXM020012E	40	78,04	79,69
25 x 3/4"	BIFXM025034E	16	94,83	96,55
32 x 1"	BIFXM032100E	14	110,47	112,89
40 x 1 1/4"	BIFXM040114E	8	133,54	137,76
50 x 1 1/2"	BIFXM050112E	4	146,44	151,95
63 x 2"	BIFXM063200E	2	160,90	167,37

Unión 3 piezas mixto PP-H / inox A316L.
Junta en EPDM o FKM.
Código en FKM termina en "F" en lugar de "E"
H-H para fusión socket-rosocar inox.



BIRXM

d x Rm	Ref. EPDM	Pack	€ EPDM	T € FKM
20 x 1/2"	BIRXM020012E	35	87,81	89,47
25 x 3/4"	BIRXM025034E	15	105,74	107,42
32 x 1"	BIRXM032100E	12	126,76	129,15
40 x 1 1/4"	BIRXM040114E	8	163,84	168,06
50 x 1 1/2"	BIRXM050112E	4	171,40	176,90
63 x 2"	BIRXM063200E	-	186,93	193,41

Unión 3 piezas mixto PP-H / inox A316L.
Junta en EPDM o FKM.
Código en FKM termina en "F" en lugar de "E"
H-M para fusión socket-rosocar inox.



VKDIM

d	Ref. EPDM	DN	€ EPDM	V € FKM
16	VKDIM016E	10	44,05	53,23
20	VKDIM020E	15	44,18	53,30
25	VKDIM025E	20	52,16	61,78
32	VKDIM032E	25	64,42	78,79
40	VKDIM040E	32	79,81	95,88
50	VKDIM050E	40	103,32	121,86
63	VKDIM063E	50	128,82	162,90

Válvula de bola DUAL BLOCK®.
Asiento PTFE (teflón). Bidireccional.
Código en FKM termina en "F" en lugar de "E"
H-H para fusión socket.



VKDFM

Rh	Ref. EPDM	DN	€ EPDM	V € FKM
1/2"	VKDFM012E	15	52,16	61,78
3/4"	VKDFM034E	20	58,55	68,72
1"	VKDFM100E	25	83,06	93,67
1 1/4"	VKDFM114E	32	88,32	106,45
1 1/2"	VKDFM112E	40	113,91	133,10
2"	VKDFM200E	50	145,90	181,04

Válvula de bola DUAL BLOCK®.
Asiento PTFE (teflón). Bidireccional.
Código en FKM termina en "F" en lugar de "E"
H-H rosocar.



VKDIM

d	Ref. EPDM	DN	€ EPDM	V € FKM
75	VKDIM075E	65	309,58	458,51
90	VKDIM090E	80	389,13	576,37
110	VKDIM110E	100	471,12	672,62

Válvula de bola DUAL BLOCK®.
Asiento PTFE (teflón). Bidireccional.
Código en FKM termina en "F" en lugar de "E"
H-H para fusión socket.



VKDDM

d	Ref. EPDM	DN	V	
			€ EPDM	€ FKM
20	VKDDM020E	15	44,18	53,30
25	VKDDM025E	20	52,16	61,78
32	VKDDM032E	25	64,42	78,79
40	VKDDM040E	32	79,81	95,88
50	VKDDM050E	40	103,32	121,86
63	VKDDM063E	50	128,82	162,90

Válvula de bola DUAL BLOCK®. Código en FKM termina en "F" en lugar de "E"
Asiento PTFE (teflón). Bidireccional.
M-M para fusión socket.



VKDOM

d	Ref. EPDM	DN	V	
			€ EPDM	€ FKM
20	VKDOM020E	15	89,08	102,90
25	VKDOM025E	20	104,65	118,53
32	VKDOM032E	25	130,90	151,39
40	VKDOM040E	32	170,81	192,81
50	VKDOM050E	40	202,60	218,55
63	VKDOM063E	50	249,83	289,69

Válvula de bola DUAL BLOCK®. Código en FKM termina en "F" en lugar de "E"
Con brida loca. Asiento PTFE (teflón). Bidireccional.

Versión con bridas ANSI 150 lbs al mismo precio



VKDDM

d	Ref. EPDM	DN	V	
			€ EPDM	€ FKM
75	VKDDM075E	65	309,58	458,51
90	VKDDM090E	80	389,13	576,37
110	VKDDM110E	100	471,12	672,62

Válvula de bola DUAL BLOCK®. Código en FKM termina en "F" en lugar de "E"
Asiento PTFE (teflón). Bidireccional.
M-M para fusión socket.



VKDOM

d	Ref. EPDM	DN	V	
			€ EPDM	€ FKM
75	VKDOM075E	65	417,94	585,83
90	VKDOM090E	80	525,33	736,33
110	VKDOM110E	100	636,03	866,34

Válvula de bola DUAL BLOCK®. Código en FKM termina en "F" en lugar de "E"
Con brida loca. Asiento PTFE (teflón). ANSI y DIN Bidireccional.



VKRBM

d	Ref. EPDM	DN	V	
			€ EPDM	€ FKM
20	VKRBM020E	15	185,28	194,86
25	VKRBM025E	20	205,35	216,57
32	VKRBM032E	25	241,12	257,56
40	VKRBM040E	32	271,64	290,82
50	VKRBM050E	40	337,45	358,73
63	VKRBM063E	50	360,73	400,09

Válvula de bola REGULACIÓN DUAL BLOCK®. Código en FKM termina en "F" en lugar de "E"
Asiento PTFE (teflón). Bidireccional
M-M para soldadura a testa.



VKRIM

d	Ref. EPDM	DN	V	
			€ EPDM	€ FKM
16	VKRIM016E	10	180,37	189,53
20	VKRIM020E	15	180,47	189,59
25	VKRIM025E	20	200,01	209,64
32	VKRIM032E	25	235,77	250,15
40	VKRIM040E	32	264,18	280,26
50	VKRIM050E	40	327,91	346,48
63	VKRIM063E	50	349,00	383,10

Válvula de bola REGULACIÓN DUAL BLOCK®. Código en FKM termina en "F" en lugar de "E"
Asiento PTFE (teflón). Bidireccional
H-H para fusión socket.



VKRFM

Rh	Ref. EPDM	DN	€ EPDM	V € FKM
3/8"	VKRFM038E	10	188,45	198,10
1/2"	VKRFM012E	15	188,45	198,10
3/4"	VKRFM034E	20	206,39	216,56
1"	VKRFM100E	25	254,44	265,04
1 1/4"	VKRFM114E	32	272,69	290,82
1 1/2"	VKRFM112E	40	338,48	357,68
2"	VKRFM200E	50	366,08	401,22

Válvula de bola **REGULACIÓN DUAL BLOCK®**. Código en FKM termina en "F" en lugar de "E"

Asiento PTFE (teflón). Bidireccional
H-H roscar.



VKRDM

d	Ref. EPDM	DN	€ EPDM	V € FKM
20	VKRDM020E	15	180,47	189,59
25	VKRDM025E	20	200,01	209,64
32	VKRDM032E	25	235,77	250,15
40	VKRDM040E	32	264,18	280,26
50	VKRDM050E	40	327,91	346,48
63	VKRDM063E	50	349,00	383,10

Válvula de bola **REGULACIÓN DUAL BLOCK®**. Código en FKM termina en "F" en lugar de "E"

Asiento PTFE (teflón). Bidireccional
M-M para fusión socket.



VKDBM

d	Ref. EPDM	DN	€ EPDM	V € FKM
20	VKDBM020E	15	48,97	58,54
25	VKDBM025E	20	57,50	68,73
32	VKDBM032E	25	69,75	86,20
40	VKDBM040E	32	87,26	106,45
50	VKDBM050E	40	112,86	134,15
63	VKDBM063E	50	140,56	179,89

Válvula de bola **DUAL BLOCK®**. Código en FKM termina en "F" en lugar de "E"

Asiento PTFE (teflón). Bidireccional
M-M para soldadura a testa.



VKDBEM

d	Ref. EPDM	DN	€ EPDM	V € FKM
20	VKDBEM020E	15	48,97	58,54
25	VKDBEM025E	20	57,50	68,72
32	VKDBEM032E	25	69,75	86,20
40	VKDBEM040E	32	87,26	106,45
50	VKDBEM050E	40	112,86	134,15
63	VKDBEM063E	50	140,56	179,89

Válvula de bola **DUAL BLOCK®**. Código en FKM termina en "F" en lugar de "E"

Asiento PTFE (teflón). Bidireccional
Long spigot PE100 SDR11.



VKDBM

d	Ref. EPDM	DN	€ EPDM	V € FKM
75	VKDBM075E	65	340,21	494,50
90	VKDBM090E	80	428,28	622,32
110	VKDBM110E	100	517,55	727,16

Válvula de bola **DUAL BLOCK®**. Código en FKM termina en "F" en lugar de "E"

Asiento PTFE (teflón). Bidireccional
M-M para soldadura a testa.



VKDBEM

d	Ref. EPDM	DN	€ EPDM	V € FKM
75	VKDBEM075E	65	340,21	494,50
90	VKDBEM090E	80	428,28	622,32
110	VKDBEM110E	100	517,55	727,16

Válvula de bola **DUAL BLOCK®**. Código en FKM termina en "F" en lugar de "E"

Asiento PTFE (teflón). Bidireccional
Long spigot PE100 SDR11.



Sistema PP-H Socket

Válvulas de 3 vías



VKRBEM

d	Ref. EPDM	DN	€ EPDM	V € FKM
20	VKRBEM020E	15	185,28	194,86
25	VKRBEM025E	20	205,35	216,56
32	VKRBEM032E	25	241,12	257,56
40	VKRBEM040E	32	271,64	290,82
50	VKRBEM050E	40	337,45	358,73
63	VKRBEM063E	50	360,73	400,09

Válvula de bola **REGULACIÓN** DUAL BLOCK®. Código en FKM termina en "F" en lugar de "E"

Asiento PTFE (teflón). Bidireccional
Long spigot PE100 SDR11.



VKROM

d	Ref. EPDM	DN	€ EPDM	V € FKM
20	VKROM020E	15	225,40	239,20
25	VKROM025E	20	252,49	266,37
32	VKROM032E	25	302,25	322,77
40	VKROM040E	32	355,18	377,17
50	VKROM050E	40	427,19	443,15
63	VKROM063E	50	470,01	509,89

Válvula de bola **REGULACIÓN** DUAL BLOCK®. Código en FKM termina en "F" en lugar de "E"

Asiento PTFE (teflón). Bidireccional
Con Brida DIN 2501.



VKROAM

d	Ref. EPDM	DN	€ EPDM	V € FKM
1/2"	VKROAM012E	15	225,40	239,20
3/4"	VKROAM034E	20	252,49	266,37
1"	VKROAM100E	25	302,25	322,77
1 1/4"	VKROAM114E	32	355,18	377,17
1 1/2"	VKROAM112E	40	427,19	443,15
2"	VKROAM200E	50	470,01	509,89

Válvula de bola **REGULACIÓN** DUAL BLOCK®. Código en FKM termina en "F" en lugar de "E"

Asiento PTFE (teflón). Bidireccional
Con bridas ANSI 150 lbs.



TKDIM

d x d x Rh	Ref.	DN	Apertura	V € EPDM
32 x 32 x 1/4"	TKDIM032ED	25	Derecha	Consultar
32 x 32 x 1/4"	TKDIM032ES	25	Izquierda	Consultar

Válvula de bola 3 vías **DESALACIÓN**. DUAL BLOCK®. H-H-H para fusión socket-rosca 1/4" toma muestras. Asiento PTFE (teflón).

Bajo pedido
suministramos otros diámetros
Disponibles también
con juntas en FKM



TKDIM

d	Ref. EPDM	DN	€ EPDM	V € FKM
20	TKDIM020E	15	79,25	89,55
25	TKDIM025E	20	89,05	102,39
32	TKDIM032E	25	114,26	131,40
40	TKDIM040E	32	130,33	153,79
50	TKDIM050E	40	154,26	192,83
63	TKDIM063E	50	195,06	243,83

Válvula de bola 3 vías **DUAL BLOCK®. PASO T.** Código en FKM termina en "F" en lugar de "E"

H-H-H para fusión socket. Asiento PTFE (teflón).



TKDFM

Rh	Ref. EPDM	DN	€ EPDM	V € FKM
1/2"	TKDFM012E	15	88,19	98,51
3/4"	TKDFM034E	20	99,32	112,66
1"	TKDFM100E	25	127,41	144,55
1 1/4"	TKDFM114E	32	145,72	169,18
1 1/2"	TKDFM112E	40	173,53	212,08
2"	TKDFM200E	50	219,47	268,23

Válvula de bola 3 vías **DUAL BLOCK®. PASO T.** Código en FKM termina en "F" en lugar de "E"

H-H-H roscar. Asiento PTFE (teflón).



LKDIM

d	Ref. EPDM	DN	€ EPDM	V € FKM
20	LKDIM020E	15	92,67	102,99
25	LKDIM025E	20	104,43	117,78
32	LKDIM032E	25	133,98	151,13
40	LKDIM040E	32	153,45	176,90
50	LKDIM050E	40	183,15	221,74
63	LKDIM063E	50	231,62	280,43

Válvula de bola 3 vías
DUAL BLOCK®. **PASO L.**
H-H-H para fusión socket. Asiento PTFE (teflón).
Código en FKM termina en "F"
en lugar de "E"



LKDFM

Rh	Ref. EPDM	DN	€ EPDM	V € FKM
½"	LKDFM012E	15	101,62	111,93
¾"	LKDFM034E	20	114,66	128,01
1"	LKDFM100E	25	147,11	164,26
1¼"	LKDFM114E	32	168,78	192,28
1½"	LKDFM112E	40	202,47	241,00
2"	LKDFM200E	50	256,01	304,80

Válvula de bola 3 vías
DUAL BLOCK®. **PASO L.**
H-H-H roscar. Asiento PTFE (teflón).
Código en FKM termina en "F"
en lugar de "E"



SETFLOM

d DIN	d ANSI	Ref. DIN	€ DIN 2501	V € ANSI
20	½"	SETFLOM020	32,27	32,27
25	¾"	SETFLOM025	37,32	37,33
32	1"	SETFLOM032	40,96	40,96
40	1¼"	SETFLOM040	54,30	54,30
50	1½"	SETFLOM050	56,47	56,47
63	2"	SETFLOM063	72,14	72,15
75	2½"	SETFLOM075	160,71	
90	3"	SETFLOM090	195,27	
110	4"	SETFLOM110	228,18	

Set embridado.
Compuesto por 1 brida, 1 anillo fijación y 1 tuerca.
Para Válvulas VKD / VKR / TKD / RVU / VRU .
d. 75-90-110,
es el mismo artículo
para DIN y ANSI



FKOM/FM

d	Ref. EPDM	DN	€ EPDM	G € FKM
50	FKOMFM050E	40	196,62	296,44
63	FKOMFM063E	50	208,20	313,89
75	FKOMFM075E	65	231,34	348,74
90	FKOMFM090E	80	251,49	374,18
110	FKOMFM110E	100	273,39	400,43
125	FKOMFM140E	125	362,77	536,28
140	FKOMFM140E	125	362,77	536,28
160	FKOMFM160E	150	400,43	575,71
200	FKOMFM225E	200	518,75	747,47
225	FKOMFM225E	200	518,75	747,47
250**	FKOMFM280E	250	1.652,88	2.674,74
280**	FKOMFM280E	250	1.652,88	2.674,74
315**	FKOMFM315E	300	1.802,76	2.916,64
355**	FKOMFM355E	350	2.832,02	5.149,87
400**	FKOMFM400E	400	3.271,11	6.616,67

Válvula de mariposa industrial.
A EJE LIBRE.
Para actuar. Cuerpo en PPGR,
eje inoxidable y disco en PP-H.
Código en FKM termina en "F"
en lugar de "E"
** ANSI 150 lbs bajo pedido
al mismo precio.

**FKOM/LM**

d	Ref. EPDM	DN	G	
			€ EPDM	€ FKM
50	FKOMLM050E	40	230,90	329,24
63	FKOMLM063E	50	244,47	348,57
75	FKOMLM075E	65	271,64	387,30
90	FKOMLM090E	80	285,65	406,58
110	FKOMLM110E	100	310,21	434,63
125	FKOMLM140E	125	411,84	582,71
140	FKOMLM140E	125	411,84	582,71
160	FKOMLM160E	150	445,12	606,38
200	FKOMLM225E	200	576,56	786,88
225	FKOMLM225E	200	576,56	786,88

Válvula de mariposa industrial.
CON MANETA.

Cuerpo en PPGR,

eje inoxidable y disco en PP-H.

Código en FKM termina en "F"
en lugar de "E"

**FKOM/RM**

d	Ref. EPDM	DN	G	
			€ EPDM	€ FKM
75	FKOMRM075E	65	623,92	738,69
90	FKOMRM090E	80	637,91	757,98
110	FKOMRM110E	100	662,43	786,88
125	FKOMRM140E	125	764,13	934,99
140	FKOMRM140E	125	764,13	934,99
160	FKOMRM160E	150	797,41	958,65
200	FKOMRM225E	200	1.008,59	1.218,91
225	FKOMRM225E	200	1.008,59	1.218,91
250**	FKOMRM280E	250	1.903,52	2.925,42
280**	FKOMRM280E	250	1.903,52	2.925,42
315**	FKOMRM315E	300	2.053,39	3.167,27
355**	FKOMRM355E	350	3.478,18	5.796,04
400**	FKOMRM400E	400	3.917,28	7.262,82

Válvula de mariposa industrial.
CON VOLANTE.

Cuerpo en PPGR,

eje inoxidable y disco en PP-H.

Código en FKM termina en "F"
en lugar de "E"

** ANSI 150 lbs bajo pedido
al mismo precio.

**FKOM/FM**

d	Ref. EPDM	DN	G	
			€ EPDM	€ FKM
75	FKOLMFM075E	65	339,97	457,42
90	FKOLMFM090E	80	393,44	516,11
110	FKOLMFM110E	100	427,60	554,66
125	FKOLMFM140E	125	568,68	742,18
140	FKOLMFM140E	125	568,68	742,18
160	FKOLMFM160E	150	623,03	798,28
200	FKOLMFM225E	200	749,21	977,91
225	FKOLMFM225E	200	749,21	977,91

Válvula de mariposa industrial.
A EJE LIBRE. LUG ISO-DIN

Para actuar. Cuerpo en PPGR,
eje inoxidable y disco en PP-H.

Código en FKM termina en "F"
en lugar de "E"

**FKOM/LM**

d	Ref. EPDM	DN	G	
			€ EPDM	€ FKM
75	FKOLMLM075E	65	380,31	495,96
90	FKOLMLM090E	80	427,62	548,55
110	FKOLMLM110E	100	464,43	588,87
125	FKOLMLM140E	125	617,75	788,62
140	FKOLMLM140E	125	617,75	788,62
160	FKOLMLM160E	150	667,73	828,95
200	FKOLMLM225E	200	807,07	1.017,35
225	FKOLMLM225E	200	807,07	1.017,35

Válvula de mariposa industrial.
CON MANETA. LUG ISO-DIN

Cuerpo en PPGR,
eje inoxidable y disco en PP-H.

Código en FKM termina en "F"
en lugar de "E"



FKOM/RM

d	Ref. EPDM	DN	G	
			€ EPDM	€ FKM
75	FKOLMRM075E	65	732,56	847,34
90	FKOLMRM090E	80	779,90	899,92
110	FKOLMRM110E	100	816,70	941,11
125	FKOLMRM140E	125	970,02	1.140,90
140	FKOLMRM140E	125	970,02	1.140,90
160	FKOLMRM160E	150	1.020,01	1.181,21
200	FKOLMRM225E	200	1.239,03	1.449,34
225	FKOLMRM225E	200	1.239,03	1.449,34

Válvula de mariposa industrial.
CON VOLANTE. LUG ISO-DIN

Cuerpo en PPGR,
 eje inoxidable y disco en PP-H.

Código en FKM termina en "F"
 en lugar de "E"



FKOM/FM

d	Ref. EPDM	DN	G	
			€ EPDM	€ FKM
2½"	FKOALMFM212E	65	394,31	511,75
3"	FKOALMFM300E	80	450,40	573,07
4"	FKOALMFM400E	100	489,81	616,90
5"	FKOALMFM500E	125	651,06	824,57
6"	FKOALMFM600E	150	712,42	887,66
8"	FKOALMFM800E	200	863,96	1.092,67
10"	FKOALMFM810E	250	2.757,66	3.779,53
12"	FKOALMFM812E	300	2.932,88	4.046,75

Válvula de mariposa industrial.
A EJE LIBRE. LUG ANSI

Para actuar. Cuerpo en PPGR,
 eje inoxidable y disco en PP-H.

Código en FKM termina en "F"
 en lugar de "E"



FKOM/LM

d	Ref. EPDM	DN	G	
			€ EPDM	€ FKM
½"	FKOALMLM212E	65	434,62	550,28
3"	FKOALMLM300E	80	484,54	605,50
4"	FKOALMLM400E	100	526,65	651,05
5"	FKOALMLM500E	125	700,12	871,00
6"	FKOALMLM600E	150	757,09	918,32
8"	FKOALMLM800E	200	921,78	1.132,10

Válvula de mariposa industrial.
CON MANETA. LUG ANSI

Cuerpo en PPGR,
 eje inoxidable y disco en PP-H.

Código en FKM termina en "F"
 en lugar de "E"



FKOM/RM

d	Ref. EPDM	DN	G	
			€ EPDM	€ FKM
2½"	FKOALMRM212E	65	786,88	901,68
3"	FKOALMRM300E	80	836,83	956,88
4"	FKOALMRM400E	100	878,89	1.003,35
5"	FKOALMRM500E	125	1.052,41	1.223,26
6"	FKOALMRM600E	150	1.109,37	1.270,57
8"	FKOALMRM800E	200	1.353,80	1.564,12
10"	FKOALMRM810E	250	3.008,35	4.030,23
12"	FKOALMRM812E	300	3.183,51	4.297,39

Válvula de mariposa industrial.
CON VOLANTE. LUG ANSI

Cuerpo en PPGR,
 eje inoxidable y disco en PP-H.

Código en FKM termina en "F"
 en lugar de "E"

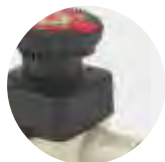

Sistema PP-H Socket

Válvulas de membrana



DKDM

d	Ref. EPDM	DN	PN	€ EPDM	€ FKM	U € PTFE
20	DKDM020E	15	10	80,06	123,93	142,61
25	DKDM025E	20	10	86,65	132,71	150,29
32	DKDM032E	25	10	101,97	146,94	164,55
40	DKDM040E	32	10	119,51	194,15	214,90
50	DKDM050E	40	10	155,69	230,32	251,09
63	DKDM063E	50	10	188,67	314,71	312,58
75	DKDM075E	65	10	226,41	377,66	375,09

Válvula de membrana
DIALOCK®.

M-M para soldar socket.

Código en FKM termina en "F"
en lugar de "E"
Código en PTFE termina en "P"
en lugar de "E"



DKOM

d	Ref. EPDM	DN	PN	€ EPDM	€ FKM	U € PTFE
20	DKOM020E	15	10	121,21	165,08	183,75
25	DKOM025E	20	10	130,23	176,28	193,89
32	DKOM032E	25	10	147,07	192,04	209,63
40	DKOM040E	32	10	178,93	253,57	274,31
50	DKOM050E	40	10	217,85	292,44	313,22
63	DKOM063E	50	10	274,90	400,99	398,81
75	DKOM075E	65	10	357,37	521,27	518,45

Válvula de membrana
DIALOCK®.

Con bridas DIN.

Código en FKM termina en "F"
en lugar de "E"
Código en PTFE termina en "P"
en lugar de "E"



VMDM

d	Ref. EPDM	DN	€ EPDM	€ FKM	U € PTFE*
90	VMDM090E	80	503,36	863,05	671,14
110	VMDM110E	100	668,97	1.265,49	876,21

Válvula de membrana.
M-M para fusión socket.

Código en FKM termina en "F"
en lugar de "E"
Código en PTFE termina en "P"
en lugar de "E"
*PN6



VMOM

d	Ref. EPDM	DN	€ EPDM	€ FKM	U € PTFE*
90	VMOM090E	80	672,73	1.032,41	840,51
110	VMOM110E	100	861,51	1.458,01	1.068,72

Válvula de membrana.
Con bridas DIN. Bajo pedido
con bridas ANSI 150 lbs. mismo precio.

Código en FKM termina en "F"
en lugar de "E"
Código en PTFE termina en "P"
en lugar de "E"
*PN6



DKLDM

d	Ref. EPDM	DN	PN	€ EPDM	€ FKM	U € PTFE
20	DKLDM020E	15	10	167,71	211,58	230,29
25	DKLDM025E	20	10	174,30	220,36	237,96
32	DKLDM032E	25	10	189,64	234,60	252,19
40	DKLDM040E	32	10	207,15	281,82	302,57
50	DKLDM050E	40	10	268,38	343,02	363,79
63	DKLDM063E	50	10	301,37	427,41	425,27
75	DKLDM075E	65	10	361,64	512,89	510,33

Válvula de membrana
DIALOCK®. **CON LIMITADOR
DE CARRERA.**

M-M para soldar socket.

Código en FKM termina en "F"
en lugar de "E"
Código en PTFE termina en "P"
en lugar de "E"



DKOAM

d	Ref. EPDM	DN	PN	€ EPDM	€ FKM	U € PTFE
½"	DKOAM012E	15	10	121,21	165,08	183,75
¾"	DKOAM034E	20	10	130,23	176,28	193,89
1"	DKOAM100E	25	10	147,07	192,04	209,63
1¼"	DKOAM114E	32	10	178,93	253,57	274,31
1½"	DKOAM112E	40	10	217,85	292,44	313,22
2"	DKOAM200E	50	10	274,90	400,99	398,81
2½"	DKOAM212E	65	10	357,37	521,27	518,34

Válvula de membrana
DIALOCK®.

Con bridas ANSI 150 lbs.

Código en FKM termina en "F"
en lugar de "E"
Código en PTFE termina en "P"
en lugar de "E"



DKUIM

d	Ref. EPDM	DN	PN	€ EPDM	€ FKM	U € PTFE
20	DKUIM020E	15	10	93,23	137,09	155,69
25	DKUIM025E	20	10	99,79	145,85	163,37
32	DKUIM032E	25	10	116,26	161,22	178,69
40	DKUIM040E	32	10	134,95	209,50	230,32
50	DKUIM050E	40	10	172,80	245,68	266,43
63	DKUIM063E	50	10	211,63	337,74	335,55

Válvula de membrana
DIALOCK®.
Con enlaces H-H para soldar socket.

Código en FKM termina en "F"
en lugar de "E"
Código en PTFE termina en "P"
en lugar de "E"



DKLUIM

d	Ref. EPDM	DN	PN	€ EPDM	€ FKM	U € PTFE
20	DKLUIM020E	15	10	180,89	224,75	243,34
25	DKLUIM025E	20	10	187,47	233,51	251,01
32	DKLUIM032E	25	10	203,93	248,88	266,35
40	DKLUIM040E	32	10	222,60	297,17	317,98
50	DKLUIM050E	40	10	285,50	358,37	379,13
63	DKLUIM063E	50	10	324,33	450,45	448,25

Válvula de membrana
DIALOCK®. **CON LIMITADOR
DE CARRERA.**

Código en FKM termina en "F"
en lugar de "E"
Código en PTFE termina en "P"
en lugar de "E"

Con enlaces H-H para soldar socket.

CMDM CMIM

M-M fusión socket. H-H fusión socket.



CMUIM CMFM

H-H enlaces socket H-H roscar.

d-Rh	Ref. EPDM	DN	€ EPDM	€ FKM	U € PTFE
20	CMDM020E	15	92,16	97,57	105,33
16	CMIM016E	12	51,53	70,21	79,00
20	CMIM020E	15	51,53	70,21	79,00
20	CMUIM020E	15	82,21	99,80	109,65
3/8"	CMFM038E	12	51,53	70,21	79,00
1/2"	CMFM012E	15	51,53	70,21	79,00

Válvula de membrana compacta.

Código en FKM termina en "F"
en lugar de "E"
Código en PTFE termina en "P"
en lugar de "E"



VRUIM

d	Ref. EPDM	DN	PN	€ EPDM	V € FKM
20	VRUIM020E	15	10	48,35	52,30
25	VRUIM025E	20	10	54,69	59,95
32	VRUIM032E	25	10	56,79	65,01
40	VRUIM040E	32	10	69,02	79,05
50	VRUIM050E	40	10	78,09	95,60
63	VRUIM063E	50	10	119,34	145,2

Válvula anti-retorno inclinada.
Juntas en EPDM o FKM.
H-H con enlaces para fusión socket.

Código en FKM termina en "F"
en lugar de "E"



VRUFM

Rh	Ref.	DN	PN	Pack	V € FKM
1/2"	VRUFM012F	15	10	2	55,45
3/4"	VRUFM034F	20	10	2	63,51
1"	VRUFM100F	25	10	2	70,21
1 1/4"	VRUFM114F	32	10	2	83,79
1 1/2"	VRUFM112F	40	10	2	101,36
2"	VRUFM200F	50	10	2	152,54

Válvula anti-retorno inclinada.
Juntas en FKM.
H-H con enlaces para roscar.



VRIM

d	Ref. EPDM	DN	PN	€ EPDM	V € FKM
75	VRIM075E	65	6	267,87	291,76
90	VRIM090E	80	4	437,51	480,27

Válvula anti-retorno inclinada.
Juntas en EPDM o FKM.
H-H para fusión socket
(sin enlaces en los extremos).

Código en FKM termina en "F"
en lugar de "E"



RVUIM

d	Ref. EPDM	DN	PN	V	
				€ EPDM	€ FKM
20	RVUIM020E	15	10	56,48	61,34
25	RVUIM025E	20	10	70,61	76,48
32	RVUIM032E	25	10	85,47	89,47
40	RVUIM040E	32	10	93,60	104,11
50	RVUIM050E	40	10	102,02	120,04
63	RVUIM063E	50	10	140,93	165,27

Filtro inclinado.

Juntas en EPDM o FKM.

H-H con enlaces para fusión socket.

Código en FKM termina en "F"
 en lugar de "E"



RVUFM

Rh	Ref.	DN	PN	Pack	V	
					€ FKM	€ FKM
½"	RVUFM012F	15	10	2	65,02	
¾"	RVUFM034F	20	10	2	81,10	
1"	RVUFM100F	25	10	2	96,65	
1¼"	RVUFM114F	32	10	2	110,34	
1½"	RVUFM112F	40	10	2	127,25	
2"	RVUFM200F	50	10	2	173,52	

Filtro inclinado.

Juntas en FKM.

H-H con enlaces para roscar.



RVIM

d	Ref. EPDM	DN	PN	V	
				€ EPDM	€ FKM
75	RVIM075E	65	6	180,44	184,19
90	RVIM090E	80	4	223,27	236,38
110	RVIM110E	100	4	408,73	465,38

Filtro inclinado.

Juntas en EPDM o FKM.

H-H para fusión socket

(sin enlaces en los extremos).

Código en FKM termina en "F"
 en lugar de "E"



SRIM

d	Ref.	DN	PN	Pack	V	
					€ FKM	€ FKM
20	SRIM020F	15	10	2	50,03	
25	SRIM025F	20	10	2	55,39	
32	SRIM032F	25	10	2	60,72	
40	SRIM040F	32	10	2	74,57	
50	SRIM050F	40	10	2	88,32	
63	SRIM063F	50	10	2	132,57	

Válvula de bola anti-retorno

Juntas en FKM.

M-H para fusión socket.



FROM

d	Ref. EPDM	DN	PN	€ EPDM	V € FKM
40	FROM040E	32	6	230,98	374,02
50	FROM050E	40	6	230,98	379,03
63	FROM063E	50	6	244,93	401,87
75	FROM075E	65	6	300,52	498,74
90	FROM090E	80	6	327,83	558,84
110	FROM110E	100	6	402,84	670,14
140	FROM140E	125	6	535,98	841,04
160	FROM160E	150	6	554,33	910,00
225	FROM225E	200	6	697,46	1.076,42
280	FROM280E	250	6	1.066,96	1.580,15
315	FROM315E	300	6	1.496,70	2.106,65

Válvula anti-retorno de clapeta sin resorte.
 ISO/DIN.

Código en FKM termina en "F" en lugar de "E"



FROM

d	Ref. EPDM	DN	PN	€ EPDM	V € FKM
40	FROM040EMLX	32	6	308,45	451,51
50	FROM050EMLX	40	6	308,45	456,52
63	FROM063EMLX	50	6	327,34	484,32
75	FROM075EMLX	65	6	387,42	585,61
90	FROM090EMLX	80	6	419,21	650,20
110	FROM110EMLX	100	6	503,67	770,94
140	FROM140EMLX	125	6	636,82	941,83
160	FROM160EMLX	150	6	684,33	1.040,05
225	FROM225EMLX	200	6	845,85	1.224,82
280	FROM280EMLX	250	6	1.244,34	1.757,53
315	FROM315EMLX	300	6	1.701,37	2.311,33

Válvula anti-retorno de clapeta con resorte inox.
 ISO/DIN.

Código en FKM termina en "FMLX" en lugar de "EMLX"



FROAM

d	Ref. EPDM	DN	PN	€ EPDM	V € FKM
1¼"	FROAM114E	32	6	283,87	426,93
1½"	FROAM112E	40	6	270,98	423,98
2"	FROAM200E	50	6	294,18	451,14
2½"	FROAM212E	65	6	357,06	555,25
3"	FROAM300E	80	6	393,69	624,68
4"	FROAM400E	100	6	477,80	750,00
5"	FROAM500E	125	6	636,31	941,32
6"	FROAM600E	150	6	653,34	1.008,99
8"	FROAM800E	200	6	847,80	1.226,81
10"	FROAM810E	250	6	1.260,62	1.773,74
12"	FROAM812E	300	6	1.818,55	2.428,57

Válvula anti-retorno de clapeta sin resorte.
 ANSI 150 lbs.

Código en FKM termina en "F" en lugar de "E"



FROAM

d	Ref. EPDM	DN	PN	€ EPDM	V € FKM
40	FROAM114EMLX	32	6	361,34	504,40
50	FROAM112EMLX	40	6	348,46	501,45
63	FROAM200EMLX	50	6	376,59	533,58
75	FROAM212EMLX	65	6	443,97	642,15
90	FROAM300EMLX	80	6	485,08	716,03
110	FROAM400EMLX	100	6	578,61	850,81
140	FROAM500EMLX	125	6	737,14	1.042,14
160	FROAM600EMLX	150	6	783,36	1.139,00
225	FROAM800EMLX	200	6	996,22	1.375,23
280	FROAM810EMLX	250	6	1.437,98	1.951,09
315	FROAM812EMLX	300	6	2.023,24	2.633,23

Válvula anti-retorno de clapeta con resorte inox.
 ANSI 150 lbs.

Código en FKM termina en "FMLX" en lugar de "EMLX"

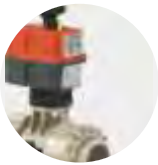

INDUSTRIA

Sistema PP-H Socket

Válvulas de bola actuadas



VKDIM/CE

soldar

VKDFM/CE

roscar.



K

ACTUACIÓN ELÉCTRICA

ACTUACIÓN ELÉCTRICA CON BLOQUEO DE SEGURIDAD

d-Rh	24-240 V AC/DC		24-240 V AC/DC		24-240 V AC/DC		24-240 V AC/DC	
	Ref.	€ EPDM	Ref.	€ FKM	Ref.	€ EPDM	Ref.	€ FKM
16	VKME016E2D	584,64	VKME016F2D	597,81	VKME016E2BD	1.079,50	VKME016F2BD	1.092,68
20	VKME020E2D	584,78	VKME020F2D	597,91	VKME020E2BD	1.079,64	VKME020F2BD	1.092,78
25	VKME025E2D	598,84	VKME025F2D	612,69	VKME025E2BD	1.093,72	VKME025F2BD	1.107,55
32	VKME032E2D	616,47	VKME032F2D	637,16	VKME032E2BD	1.111,34	VKME032F2BD	1.132,03
40	VKME040E2D	645,09	VKME040F2D	668,24	VKME040E2BD	1.139,96	VKME040F2BD	1.163,12
50	VKME050E2D	678,91	VKME050F2D	705,60	VKME050E2BD	1.173,80	VKME050F2BD	1.200,48
63	VKME063E2D	718,80	VKME063F2D	767,87	VKME063E2BD	1.213,68	VKME063F2BD	1.262,75
75	VKME075E2D	1.156,42	VKME075F2D	1.272,72	VKME075E2BD	1.651,30	VKME075F2BD	1.767,57
90	VKME090E2D	1.271,01	VKME090F2D	1.417,20	VKME090E2BD	1.765,88	VKME090F2BD	1.912,08
110	VKME110E2D	1.725,98	VKME110F2D	1.872,09	VKME110E2BD	2.220,84	VKME110F2BD	2.366,97
3/8"	VKME038E2D	596,27	VKME038F2D	610,14	VKME038E2BD	1.091,13	VKME038F2BD	1.105,00
1/2"	VKME012E2D	596,27	VKME012F2D	610,14	VKME012E2BD	1.091,13	VKME012F2BD	1.105,00
3/4"	VKME034E2D	608,03	VKME034F2D	622,65	VKME034E2BD	1.102,90	VKME034F2BD	1.117,53
1"	VKME100E2D	643,36	VKME100F2D	658,64	VKME100E2BD	1.138,23	VKME100F2BD	1.153,50
1 1/4"	VKME114E2D	657,37	VKME114F2D	683,43	VKME114E2BD	1.152,21	VKME114F2BD	1.178,31
1 1/2"	VKME112E2D	694,16	VKME112F2D	721,83	VKME112E2BD	1.189,04	VKME112F2BD	1.216,67
2"	VKME200E2D	743,36	VKME200F2D	793,97	VKME200E2BD	1.238,25	VKME200F2BD	1.288,86

Válvula de bola motorizada en PP-H 2 vías DUAL BLOCK®. Actuación eléctrica.

Disponemos de otras conexiones bajo pedido: bridas, soldar macho y roscar (NPT)
Bajo pedido podemos suministrar otros actuadores: VALPES, BELIMO...
Bajo pedido también disponibles en 12 V AC/DC

VKRIM/CE

soldar.

VKRFM/CE

roscar.



K

ACTUACIÓN ELÉCTRICA 24-240 V AC/DC CON POSICIONADOR 4-20 mA

d	Ref.	€ EPDM	Ref.	€ FKM	Ref.	€ EPDM	Ref.	€ FKM	Rh
16	VRME016E2PD	1.194,85	VRME016F2PD	1.208,03	VRME038E2PD	1.206,50	VRME038F2PD	1.220,38	3/8"
20	VRME020E2PD	1.195,02	VRME020F2PD	1.208,16	VRME012E2PD	1.206,50	VRME012F2PD	1.220,38	1/2"
25	VRME025E2PD	1.225,68	VRME025F2PD	1.239,59	VRME034E2PD	1.234,88	VRME034F2PD	1.249,50	3/4"
32	VRME032E2PD	1.277,22	VRME032F2PD	1.297,91	VRME100E2PD	1.304,04	VRME100F2PD	1.319,33	1"
40	VRME040E2PD	1.324,51	VRME040F2PD	1.347,61	VRME114E2PD	1.336,73	VRME114F2PD	1.362,87	1 1/4"
50	VRME050E2PD	1.416,23	VRME050F2PD	1.443,03	VRME112E2PD	1.431,44	VRME112F2PD	1.459,11	1 1/2"
63	VRME063E2PD	1.449,80	VRME063F2PD	1.498,89	VRME200E2PD	1.474,35	VRME200F2PD	1.524,99	2"

Válvula de bola REGULACIÓN motorizada en PP-H 2 vías DUAL BLOCK®. Actuación eléctrica con posicionador 4-20 mA

Disponemos de otras conexiones bajo pedido: bridas, soldar macho y roscar (NPT)
Bajo pedido podemos suministrar otros actuadores: VALPES, BELIMO...
Bajo pedido también disponibles en 12 V AC/DC



K

VKDIM/CP

soldar.

VKDFM/CP

roscar.

ACTUACIÓN NEUMÁTICA ALUMINIO

ACTUACIÓN NEUMÁTICA ALUMINIO CON ELECTROVÁLVULA, FINALES DE CARRERA (ELECTROMECAÑICOS) Y REGULADORES DE ESCAPE

d-Rh	DOBLE EFECTO		SIMPLE EFECTO		DOBLE EFECTO		SIMPLE EFECTO	
	Ref.	€	Ref.	€	Ref.	€	Ref.	€
16	VKMP016EDED	283,62	VKMP016ESED	311,01	VKMP016EDEFD	462,63	VKMP016ESEFD	499,48
20	VKMP020EDED	283,77	VKMP020ESED	311,17	VKMP020EDEFD	462,77	VKMP020ESEFD	499,63
25	VKMP025EDED	297,84	VKMP025ESED	325,23	VKMP025EDEFD	476,83	VKMP025ESEFD	513,69
32	VKMP032EDED	315,47	VKMP032ESED	342,86	VKMP032EDEFD	494,47	VKMP032ESEFD	531,32
40	VKMP040EDED	344,10	VKMP040ESED	371,49	VKMP040EDEFD	523,08	VKMP040ESEFD	559,94
50	VKMP050EDED	377,92	VKMP050ESED	458,50	VKMP050EDEFD	556,91	VKMP050ESEFD	646,97
63	VKMP063EDED	417,80	VKMP063ESED	568,77	VKMP063EDEFD	596,80	VKMP063ESEFD	757,22
75	VKMP075EDED	711,48	VKMP075ESED	818,31	VKMP075EDEFD	890,47	VKMP075ESEFD	1.006,78
90	VKMP090EDED	826,08	VKMP090ESED	932,90	VKMP090EDEFD	1.005,07	VKMP090ESEFD	1.121,36
110	VKMP110EDED	968,17	VKMP110ESED	1.346,25	VKMP110EDEFD	1.147,18	VKMP110ESEFD	1.534,72
3/8"	VKMP038EDED	295,28	VKMP038ESED	322,67	VKMP038EDEFD	474,27	VKMP038ESEFD	511,12
	VKMP012EDED	295,28	VKMP012ESED	322,67	VKMP012EDEFD	474,27	VKMP012ESEFD	511,12
	VKMP034EDED	307,03	VKMP034ESED	334,42	VKMP034EDEFD	486,02	VKMP034ESEFD	522,88
	VKMP100EDED	342,35	VKMP100ESED	369,76	VKMP100EDEFD	521,35	VKMP100ESEFD	558,20
	VKMP114EDED	356,37	VKMP114ESED	383,76	VKMP114EDEFD	535,36	VKMP114ESEFD	572,22
	VKMP112EDED	393,15	VKMP112ESED	473,76	VKMP112EDEFD	572,17	VKMP112ESEFD	662,21
2"	VKMP200EDED	442,39	VKMP200ESED	593,37	VKMP200EDEFD	621,38	VKMP200ESEFD	781,82
16	VKMP016FDED	296,81	VKMP016FSED	324,22	VKMP016FDEFD	475,80	VKMP016FSEFD	512,67
20	VKMP020FDED	296,91	VKMP020FSED	324,30	VKMP020FDEFD	475,90	VKMP020FSEFD	512,75
25	VKMP025FDED	311,69	VKMP025FSED	339,10	VKMP025FDEFD	490,70	VKMP025FSEFD	527,55
32	VKMP032FDED	336,16	VKMP032FSED	363,57	VKMP032FDEFD	515,16	VKMP032FSEFD	552,01
40	VKMP040FDED	367,24	VKMP040FSED	394,63	VKMP040FDEFD	546,24	VKMP040FSEFD	583,09
50	VKMP050FDED	404,59	VKMP050FSED	485,20	VKMP050FDEFD	583,60	VKMP050FSEFD	673,67
63	VKMP063FDED	466,86	VKMP063FSED	617,85	VKMP063FDEFD	645,87	VKMP063FSEFD	806,31
75	VKMP075FDED	827,78	VKMP075FSED	934,60	VKMP075FDEFD	1.006,78	VKMP075FSEFD	1.123,05
90	VKMP090FDED	972,26	VKMP090FSED	1.079,09	VKMP090FDEFD	1.151,26	VKMP090FSEFD	1.267,55
110	VKMP110FDED	1.114,32	VKMP110FSED	1.492,40	VKMP110FDEFD	1.293,31	VKMP110FSEFD	1.680,84
3/8"	VKMP038FDED	309,14	VKMP038FSED	336,52	VKMP038FDEFD	488,12	VKMP038FSEFD	524,97
1/2"	VKMP012FDED	309,14	VKMP012FSED	336,52	VKMP012FDEFD	488,12	VKMP012FSEFD	524,97
3/4"	VKMP034FDED	321,67	VKMP034FSED	349,03	VKMP034FDEFD	500,64	VKMP034FSEFD	537,49
1"	VKMP100FDED	357,63	VKMP100FSED	385,03	VKMP100FDEFD	536,64	VKMP100FSEFD	573,49
1 1/4"	VKMP114FDED	382,43	VKMP114FSED	409,84	VKMP114FDEFD	561,43	VKMP114FSEFD	598,27
1 1/2"	VKMP112FDED	420,81	VKMP112FSED	501,41	VKMP112FDEFD	599,80	VKMP112FSEFD	689,86
2"	VKMP200FDED	492,98	VKMP200FSED	643,97	VKMP200FDEFD	671,98	VKMP200FSEFD	832,41

Válvula de bola motorizada en PP-H 2 vías DUAL BLOCK®. Actuación neumática

Disponemos de otras conexiones bajo pedido: bridas, soldar macho y roscar (NPT)
Las válvulas neumáticas se configuran NC (normalmente cerrada) de serie.
La configuración NA (normalmente abierta) se debe especificar en el pedido



K

VKRIM/CP

soldar.

VKRFM/CP

roscar.

ACTUACIÓN NEUMÁTICA ALUMINIO DOBLE EFECTO
CON POSICIONADOR 4-20 mA

ACTUACIÓN NEUMÁTICA ALUMINIO SIMPLE EFECTO
CON POSICIONADOR 4-20 mA

d-Rh	Ref.	€ EPDM	Ref.	€ FKM	Ref.	€ EPDM	Ref.	€ FKM
16	VRMP016EDEPD	2.074,56	VRMP016FDEPD	2.087,75	VRMP016ESEPD	2.101,96	VRMP016FSEPD	2.115,14
20	VRMP020EDEPD	2.074,70	VRMP020FDEPD	2.087,86	VRMP020ESEPD	2.102,11	VRMP020FSEPD	2.115,22
25	VRMP025EDEPD	2.105,40	VRMP025FDEPD	2.119,28	VRMP025ESEPD	2.132,77	VRMP025FSEPD	2.146,68
32	VRMP032EDEPD	2.156,89	VRMP032FDEPD	2.177,60	VRMP032ESEPD	2.184,30	VRMP032FSEPD	2.204,99
40	VRMP040EDEPD	2.204,23	VRMP040FDEPD	2.227,34	VRMP040ESEPD	2.231,64	VRMP040FSEPD	2.254,75
50	VRMP050EDEPD	2.295,92	VRMP050FDEPD	2.322,69	VRMP050ESEPD	2.376,53	VRMP050FSEPD	2.403,30
63	VRMP063EDEPD	2.329,51	VRMP063FDEPD	2.378,58	VRMP063ESEPD	2.480,49	VRMP063FSEPD	2.529,57
3/8"	VRMP038EDEPD	2.086,21	VRMP038FDEPD	2.100,06	VRMP038ESEPD	2.113,61	VRMP038FSEPD	2.127,46
1/2"	VRMP012EDEPD	2.086,21	VRMP012FDEPD	2.100,06	VRMP012ESEPD	2.113,61	VRMP012FSEPD	2.127,46
3/4"	VRMP034EDEPD	2.114,59	VRMP034FDEPD	2.129,21	VRMP034ESEPD	2.141,96	VRMP034FSEPD	2.156,59
1"	VRMP100EDEPD	2.183,74	VRMP100FDEPD	2.199,02	VRMP100ESEPD	2.211,13	VRMP100FSEPD	2.226,42
1 1/4"	VRMP114EDEPD	2.216,44	VRMP114FDEPD	2.242,58	VRMP114ESEPD	2.243,85	VRMP114FSEPD	2.269,94
1 1/2"	VRMP112EDEPD	2.311,16	VRMP112FDEPD	2.338,80	VRMP112ESEPD	2.391,77	VRMP112FSEPD	2.419,42
2"	VRMP200EDEPD	2.354,05	VRMP200FDEPD	2.404,72	VRMP200ESEPD	2.505,04	VRMP200FSEPD	2.555,68

Válvula de bola **REGULACIÓN** motorizada en PP-H 2 vías DUAL BLOCK®.

Actuación neumática con posicionador 4-20 mA

Disponemos de otras conexiones bajo pedido: bridas, soldar macho y roscar (NPT)

Las válvulas neumáticas se configuran NC (normalmente cerrada) de serie. La configuración NA (normalmente abierta) se debe especificar en el pedido

VKRIM/CP

encolar.

VKRFM/CP

roscar.

ACTUACIÓN NEUMÁTICA POLIAMIDA DOBLE EFECTO
CON POSICIONADOR 4-20 mA

ACTUACIÓN NEUMÁTICA POLIAMIDA SIMPLE EFECTO
CON POSICIONADOR 4-20 mA

d-Rh	Ref.	€ EPDM	Ref.	€ FKM	Ref.	€ EPDM	Ref.	€ FKM
16	VRMP016EDEPP	1.682,27	VRMP016FDEPP	1.695,46	VRMP016ESEPP	1.702,92	VRMP016FSEPP	1.716,11
20	VRMP020EDEPP	1.682,41	VRMP020FDEPP	1.695,56	VRMP020ESEPP	1.703,05	VRMP020FSEPP	1.716,21
25	VRMP025EDEPP	1.713,09	VRMP025FDEPP	1.726,97	VRMP025ESEPP	1.733,73	VRMP025FSEPP	1.747,65
32	VRMP032EDEPP	1.764,60	VRMP032FDEPP	1.785,30	VRMP032ESEPP	1.878,13	VRMP032FSEPP	1.898,83
40	VRMP040EDEPP	1.811,94	VRMP040FDEPP	1.835,05	VRMP040ESEPP	1.925,47	VRMP040FSEPP	1.948,56
50	VRMP050EDEPP	1.903,62	VRMP050FDEPP	1.930,41	VRMP050ESEPP	2.125,53	VRMP050FSEPP	2.152,29
63	VRMP063EDEPP	2.119,28	VRMP063FDEPP	2.168,36	VRMP063ESEPP	2.178,62	VRMP063FSEPP	2.227,69
3/8"	VRMP038EDEPP	1.693,92	VRMP038FDEPP	1.707,78	VRMP038ESEPP	1.714,58	VRMP038FSEPP	1.728,43
1/2"	VRMP012EDEPP	1.693,92	VRMP012FDEPP	1.693,92	VRMP012ESEPP	1.714,58	VRMP012FSEPP	1.728,43
3/4"	VRMP034EDEPP	1.722,30	VRMP034FDEPP	1.736,90	VRMP034ESEPP	1.742,96	VRMP034FSEPP	1.757,56
1"	VRMP100EDEPP	1.791,44	VRMP100FDEPP	1.806,73	VRMP100ESEPP	1.904,97	VRMP100FSEPP	1.920,24
1 1/4"	VRMP114EDEPP	1.824,14	VRMP114FDEPP	1.850,29	VRMP114ESEPP	1.937,67	VRMP114FSEPP	1.963,80
1 1/2"	VRMP112EDEPP	1.918,87	VRMP112FDEPP	1.946,52	VRMP112ESEPP	2.140,75	VRMP112FSEPP	2.168,40
2"	VRMP200EDEPP	2.143,82	VRMP200FDEPP	2.194,47	VRMP200ESEPP	2.203,15	VRMP200FSEPP	2.253,80

Válvula de bola **REGULACIÓN** motorizada en PP-H 2 vías DUAL BLOCK®.

Actuación neumática con posicionador 4-20 mA

Disponemos de otras conexiones bajo pedido: bridas, soldar macho y roscar (NPT)

Las válvulas neumáticas se configuran NC (normalmente cerrada) de serie. La configuración NA (normalmente abierta) se debe especificar en el pedido



K

VKDIM/CP

soldar.

VKDFM/CP

roscar.

ACTUACIÓN NEUMÁTICA POLIAMIDA

ACTUACIÓN NEUMÁTICA POLIAMIDA CON ELECTROVÁLVULA, FINALES DE CARRERA (ELECTROMECAÑICOS) Y REGULADORES DE ESCAPE

d-Rh	DOBLE EFECTO		SIMPLE EFECTO		DOBLE EFECTO		SIMPLE EFECTO		
	Ref.	€	Ref.	€	Ref.	€	Ref.	€	
16	VKMP016EDEP	300,34	VKMP016ESEP	320,99	VKMP016EDEFPP	534,48	VKMP016ESEFP	555,14	
20	VKMP020EDEP	300,49	VKMP020ESEP	321,13	VKMP020EDEFPP	534,64	VKMP020ESEFP	555,28	
25	VKMP025EDEP	314,53	VKMP025ESEP	335,19	VKMP025EDEFPP	548,68	VKMP025ESEFP	569,33	
32	VKMP032EDEP	332,20	VKMP032ESEP	445,72	VKMP032EDEFPP	566,32	VKMP032ESEFP	679,86	
40	VKMP040EDEP	360,80	VKMP040ESEP	474,34	VKMP040EDEFPP	594,93	VKMP040ESEFP	708,49	
50	VKMP050EDEP	394,63	VKMP050ESEP	616,52	VKMP050EDEFPP	628,78	VKMP050ESEFP	850,67	
63	VKMP063EDEP	616,56	VKMP063ESEP	675,92	VKMP063EDEFPP	850,72	VKMP063ESEFP	910,05	
75	VKMP075EDEP	826,60	VKMP075ESEP	1.048,89	VKMP075EDEFPP	1.060,73	VKMP075ESEFP	1.283,03	
90	VKMP090EDEP	941,19	VKMP090ESEP	1.163,47	VKMP090EDEFPP	1.175,34	VKMP090ESEFP	1.397,62	
110	VKMP110EDEP	1.053,51	VKMP110ESEP	1.294,74	VKMP110EDEFPP	1.287,63	VKMP110ESEFP	1.528,89	

3/8"	VKMP038EDEP	311,99	VKMP038ESEP	332,64	VKMP038EDEFPP	546,15	VKMP038ESEFP	566,81	
	1/2"	VKMP012EDEP	311,99	VKMP012ESEP	332,64	VKMP012EDEFPP	546,15	VKMP012ESEFP	566,81
	3/4"	VKMP034EDEP	323,76	VKMP034ESEP	344,40	VKMP034EDEFPP	557,90	VKMP034ESEFP	578,55
	1"	VKMP100EDEP	359,06	VKMP100ESEP	472,59	VKMP100EDEFPP	593,21	VKMP100ESEFP	706,73
	1 1/4"	VKMP114EDEP	373,09	VKMP114ESEP	486,60	VKMP114EDEFPP	607,23	VKMP114ESEFP	720,75
	1 1/2"	VKMP112EDEP	409,88	VKMP112ESEP	631,76	VKMP112EDEFPP	644,03	VKMP112ESEFP	865,91
2"	VKMP200EDEP	641,16	VKMP200ESEP	700,50	VKMP200EDEFPP	875,30	VKMP200ESEFP	934,64	

16	VKMP016FDEP	313,53	VKMP016FSEP	334,18	VKMP016FDEFPP	547,67	VKMP016FSEFP	568,33	
20	VKMP020FDEP	313,63	VKMP020FSEP	334,28	VKMP020FDEFPP	547,78	VKMP020FSEFP	568,44	
25	VKMP025FDEP	328,40	VKMP025FSEP	349,03	VKMP025FDEFPP	562,55	VKMP025FSEFP	583,19	
32	VKMP032FDEP	352,89	VKMP032FSEP	466,40	VKMP032FDEFPP	587,03	VKMP032FSEFP	700,55	
40	VKMP040FDEP	383,95	VKMP040FSEP	497,48	VKMP040FDEFPP	618,11	VKMP040FSEFP	731,61	
50	VKMP050FDEP	421,32	VKMP050FSEP	643,20	VKMP050FDEFPP	655,46	VKMP050FSEFP	877,35	
63	VKMP063FDEP	665,66	VKMP063FSEP	724,99	VKMP063FDEFPP	899,78	VKMP063FSEFP	959,14	
75	VKMP075FDEP	942,87	VKMP075FSEP	1.165,15	VKMP075FDEFPP	1.177,02	VKMP075FSEFP	1.399,30	
90	VKMP090FDEP	1.087,39	VKMP090FSEP	1.309,67	VKMP090FDEFPP	1.321,54	VKMP090FSEFP	1.543,80	
110	VKMP110FDEP	1.199,61	VKMP110FSEP	1.440,86	VKMP110FDEFPP	1.433,75	VKMP110FSEFP	1.675,02	

3/8"	VKMP038FDEP	325,85	VKMP038FSEP	346,50	VKMP038FDEFPP	559,99	VKMP038FSEFP	580,64	
1/2"	VKMP012FDEP	311,99	VKMP012FSEP	346,50	VKMP012FDEFPP	546,15	VKMP012FSEFP	580,64	
3/4"	VKMP034FDEP	338,36	VKMP034FSEP	359,00	VKMP034FDEFPP	572,52	VKMP034FSEFP	593,17	
1"	VKMP100FDEP	374,35	VKMP100FSEP	487,87	VKMP100FDEFPP	608,52	VKMP100FSEFP	722,02	
1 1/4"	VKMP114FDEP	399,12	VKMP114FSEP	512,67	VKMP114FDEFPP	633,29	VKMP114FSEFP	746,81	
1 1/2"	VKMP112FDEP	437,52	VKMP112FSEP	659,40	VKMP112FDEFPP	671,66	VKMP112FSEFP	893,55	
2"	VKMP200FDEP	691,75	VKMP200FSEP	751,10	VKMP200FDEFPP	925,91	VKMP200FSEFP	985,24	

Válvula de bola motorizada en PP-H 2 vías DUAL BLOCK®. Actuación neumática

Disponemos de otras conexiones bajo pedido: bridas, soldar macho y roscar (NPT)
 Las válvulas neumáticas se configuran NC (normalmente cerrada) de serie.
 La configuración NA (normalmente abierta) se debe especificar en el pedido



K

LKDIM/CE

soldar.

LKDFM/CE

roscar.

d-Rh	ACTUACIÓN ELÉCTRICA				ACTUACIÓN ELÉCTRICA CON BLOQUE DE SEGURIDAD			
	24-240 V AC/DC		24-240 V AC/DC		24-240 V AC/DC		24-240 V AC/DC	
	Ref.	€ EPDM	Ref.	€ FKM	Ref.	€ EPDM	Ref.	€ FKM
20	LKME020E2D	654,60	LKME020F2D	669,42	LKME020E2BD	1.149,47	LKME020F2BD	1.164,29
25	LKME025E2D	674,08	LKME025F2D	693,30	LKME025E2BD	1.168,94	LKME025F2BD	1.188,16
32	LKME032E2D	716,59	LKME032F2D	741,30	LKME032E2BD	1.211,47	LKME032F2BD	1.236,15
40	LKME040E2D	751,05	LKME040F2D	784,85	LKME040E2BD	1.245,93	LKME040F2BD	1.279,70
50	LKME050E2D	793,84	LKME050F2D	849,34	LKME050E2BD	1.288,70	LKME050F2BD	1.344,20
63	LKME063E2D	866,76	LKME063F2D	936,99	LKME063E2BD	1.361,65	LKME063F2BD	1.431,86
1/2"	LKME012E2D	667,47	LKME012F2D	682,32	LKME012E2BD	1.162,35	LKME012F2BD	1.177,18
3/4"	LKME034E2D	688,79	LKME034F2D	708,00	LKME034E2BD	1.183,67	LKME034F2BD	1.202,88
1"	LKME100E2D	735,50	LKME100F2D	760,20	LKME100E2BD	1.230,39	LKME100F2BD	1.255,08
1 1/4"	LKME114E2D	773,14	LKME114F2D	806,97	LKME114E2BD	1.268,00	LKME114F2BD	1.301,83
1 1/2"	LKME112E2D	821,62	LKME112F2D	877,09	LKME112E2BD	1.316,52	LKME112F2BD	1.371,97
2"	LKME200E2D	901,88	LKME200F2D	972,06	LKME200E2BD	1.396,75	LKME200F2BD	1.466,93

Válvula de bola motorizada en PP-H 3 vías DUAL BLOCK®. Actuación eléctrica

Estándar paso en L, paso en T opcional, al mismo precio. Bajo pedido podemos suministrar otros actuadores: VALPES, BELIMO... Disponemos de otras conexiones bajo pedido: bridas, soldar macho y roscar (NPT)

Bajo pedido también disponibles en 12 V AC/DC



LKDIM/CP

soldar.

LKDFM/CP

roscar.

K

ACTUACIÓN NEUMÁTICA ALUMINIO

ACTUACIÓN NEUMÁTICA ALUMINIO CON ELECTROVÁLVULA, FINALES DE CARRERA (ELECTROMECAÑICOS) Y REGULADORES DE ESCAPE

	d-Rh	DOBLE EFECTO		SIMPLE EFECTO		DOBLE EFECTO		SIMPLE EFECTO	
		Ref.	€	Ref.	€	Ref.	€	Ref.	€
SOLDAR EPDM	20	LKMP020EDED	353,61	LKMP020ESED	380,98	LKMP020EDEFD	532,59	LKMP020ESEFD	569,44
	25	LKMP025EDED	373,09	LKMP025ESED	400,46	LKMP025EDEFD	552,06	LKMP025ESEFD	588,93
	32	LKMP032EDED	415,61	LKMP032ESED	442,99	LKMP032EDEFD	594,59	LKMP032ESEFD	631,44
	40	LKMP040EDED	450,06	LKMP040ESED	530,65	LKMP040EDEFD	629,06	LKMP040ESEFD	719,10
	50	LKMP050EDED	524,73	LKMP050ESED	643,80	LKMP050EDEFD	703,72	LKMP050ESEFD	832,27
	63	LKMP063EDED	597,67	LKMP063ESED	716,75	LKMP063EDEFD	776,65	LKMP063ESEFD	905,22
ROSCAR EPDM	1/2"	LKMP012EDED	366,47	LKMP012ESED	393,88	LKMP012EDEFD	545,48	LKMP012ESEFD	582,33
	3/4"	LKMP034EDED	387,80	LKMP034ESED	415,20	LKMP034EDEFD	566,81	LKMP034ESEFD	603,63
	1"	LKMP100EDED	434,49	LKMP100ESED	461,91	LKMP100EDEFD	613,50	LKMP100ESEFD	650,37
	1 1/4"	LKMP114EDED	472,13	LKMP114ESED	552,74	LKMP114EDEFD	651,13	LKMP114ESEFD	741,18
	1 1/2"	LKMP112EDED	552,52	LKMP112ESED	671,62	LKMP112EDEFD	731,52	LKMP112ESEFD	860,07
	2"	LKMP200EDED	632,76	LKMP200ESED	751,86	LKMP200EDEFD	811,76	LKMP200ESEFD	940,32
SOLDAR FKM	20	LKMP020FDED	368,41	LKMP020FSED	395,82	LKMP020FDEFD	547,41	LKMP020FSEFD	584,28
	25	LKMP025FDED	392,30	LKMP025FSED	419,69	LKMP025FDEFD	571,30	LKMP025FSEFD	608,15
	32	LKMP032FDED	440,28	LKMP032FSED	467,68	LKMP032FDEFD	619,28	LKMP032FSEFD	656,14
	40	LKMP040FDED	483,85	LKMP040FSED	564,44	LKMP040FDEFD	662,85	LKMP040FSEFD	752,89
	50	LKMP050FDED	580,24	LKMP050FSED	699,32	LKMP050FDEFD	759,24	LKMP050FSEFD	887,78
	63	LKMP063FDED	667,88	LKMP063FSED	786,97	LKMP063FDEFD	846,88	LKMP063FSEFD	975,43
ROSCAR FKM	1/2"	LKMP012FDED	381,29	LKMP012FSED	408,70	LKMP012FDEFD	560,30	LKMP012FSEFD	597,15
	3/4"	LKMP034FDED	407,00	LKMP034FSED	434,41	LKMP034FDEFD	586,00	LKMP034FSEFD	622,87
	1"	LKMP100FDED	459,18	LKMP100FSED	486,60	LKMP100FDEFD	638,19	LKMP100FSEFD	675,04
	1 1/4"	LKMP114FDED	505,97	LKMP114FSED	586,57	LKMP114FDEFD	684,96	LKMP114FSEFD	775,03
	1 1/2"	LKMP112FDED	607,99	LKMP112FSED	727,08	LKMP112FDEFD	786,97	LKMP112FSEFD	915,53
	2"	LKMP200FDED	702,96	LKMP200FSED	822,04	LKMP200FDEFD	881,96	LKMP200FSEFD	1.010,48

Válvula de bola motorizada en PP-H 3 vías DUAL BLOCK®. Actuación neumática

Estándar paso en L, paso en T opcional al mismo precio. Disponemos de otras conexiones bajo pedido: bridas, soldar macho y roscar (NPT). Las válvulas neumáticas se configuran NC (normalmente cerrada) de serie. La configuración NA (normalmente abierta) se debe especificar en el pedido.

**LKDIM/CP**

soldar.

LKDFM/CP

roscar.

ACTUACIÓN NEUMÁTICA POLIAMIDA

ACTUACIÓN NEUMÁTICA POLIAMIDA CON ELECTROVÁLVULA, FINALES DE CARRERA (ELECTROMECÁNICOS) Y REGULADORES DE ESCAPE

	d-Rh	DOBLE EFECTO		SIMPLE EFECTO		DOBLE EFECTO		SIMPLE EFECTO		K
		Ref.	€	Ref.	€	Ref.	€	Ref.	€	
S O L D A R E P D M	20	LKMP020EDEP	405,49	LKMP020ESEP	426,15	LKMP020EDEFPP	639,62	LKMP020ESEFP	660,27	S O L D A R E P D M
	25	LKMP025EDEP	465,29	LKMP025ESEP	485,91	LKMP025EDEFPP	699,43	LKMP025ESEFP	720,07	
	32	LKMP032EDEP	507,82	LKMP032ESEP	621,31	LKMP032EDEFPP	741,95	LKMP032ESEFP	855,46	
	40	LKMP040EDEP	555,54	LKMP040ESEP	777,42	LKMP040EDEFPP	789,70	LKMP040ESEFP	1.011,56	
	50	LKMP050EDEP	681,29	LKMP050ESEP	817,99	LKMP050EDEFPP	915,43	LKMP050ESEFP	1.052,15	
	63	LKMP063EDEP	822,16	LKMP063ESEP	881,50	LKMP063EDEFPP	1.056,2	LKMP063ESEFP	1.115,64	

	d-Rh	DOBLE EFECTO		SIMPLE EFECTO		DOBLE EFECTO		SIMPLE EFECTO		K
		Ref.	€	Ref.	€	Ref.	€	Ref.	€	
R O S C A R E P D M	1/2"	LKMP012EDEP	418,35	LKMP012ESEP	439,00	LKMP012EDEFPP	652,49	LKMP012ESEFP	673,15	R O S C A R E P D M
	3/4"	LKMP034EDEP	480,01	LKMP034ESEP	500,64	LKMP034EDEFPP	714,16	LKMP034ESEFP	734,81	
	1"	LKMP100EDEP	526,73	LKMP100ESEP	640,25	LKMP100EDEFPP	760,87	LKMP100ESEFP	874,39	
	1 1/4"	LKMP114EDEP	577,63	LKMP114ESEP	799,50	LKMP114EDEFPP	811,76	LKMP114ESEFP	1.033,66	
	1 1/2"	LKMP112EDEP	709,08	LKMP112ESEP	845,80	LKMP112EDEFPP	943,23	LKMP112ESEFP	1.079,96	
	2"	LKMP200EDEP	857,26	LKMP200ESEP	916,62	LKMP200EDEFPP	1.091,42	LKMP200ESEFP	1.150,76	

	d-Rh	DOBLE EFECTO		SIMPLE EFECTO		DOBLE EFECTO		SIMPLE EFECTO		K
		Ref.	€	Ref.	€	Ref.	€	Ref.	€	
S O L D A R F K M	20	LKMP020FDEP	420,29	LKMP020FSEP	440,94	LKMP020FDEFPP	654,44	LKMP020FSEFP	675,10	S O L D A R F K M
	25	LKMP025FDEP	484,50	LKMP025FSEP	505,14	LKMP025FDEFPP	718,64	LKMP025FSEFP	739,29	
	32	LKMP032FDEP	532,48	LKMP032FSEP	646,01	LKMP032FDEFPP	766,64	LKMP032FSEFP	880,17	
	40	LKMP040FDEP	589,32	LKMP040FSEP	811,22	LKMP040FDEFPP	823,48	LKMP040FSEFP	1.045,35	
	50	LKMP050FDEP	736,79	LKMP050FSEP	873,51	LKMP050FDEFPP	970,94	LKMP050FSEFP	1.107,66	
	63	LKMP063FDEP	892,37	LKMP063FSEP	951,71	LKMP063FDEFPP	1.126,53	LKMP063FSEFP	1.185,86	

	d-Rh	DOBLE EFECTO		SIMPLE EFECTO		DOBLE EFECTO		SIMPLE EFECTO		K
		Ref.	€	Ref.	€	Ref.	€	Ref.	€	
R O S C A R F K M	1/2"	LKMP012FDEP	433,19	LKMP012FSEP	453,83	LKMP012FDEFPP	667,34	LKMP012FSEFP	687,99	R O S C A R F K M
	3/4"	LKMP034FDEP	499,22	LKMP034FSEP	519,86	LKMP034FDEFPP	733,36	LKMP034FSEFP	754,00	
	1"	LKMP100FDEP	551,40	LKMP100FSEP	664,93	LKMP100FDEFPP	785,55	LKMP100FSEFP	899,08	
	1 1/4"	LKMP114FDEP	611,47	LKMP114FSEP	833,34	LKMP114FDEFPP	845,62	LKMP114FSEFP	1.067,48	
	1 1/2"	LKMP112FDEP	764,54	LKMP112FSEP	901,26	LKMP112FDEFPP	998,69	LKMP112FSEFP	1.135,41	
	2"	LKMP200FDEP	927,43	LKMP200FSEP	986,79	LKMP200FDEFPP	1.161,58	LKMP200FSEFP	1.220,93	

Válvula de bola motorizada en PP-H 3 vías DUAL BLOCK®. Actuación neumática

Estándar paso en L, paso en T opcional, al mismo precio. Disponemos de otras conexiones bajo pedido: bridas, soldar macho y roscar (NPT). Las válvulas neumáticas se configuran NC (normalmente cerrada) de serie. La configuración NA (normalmente abierta) se debe especificar en el pedido.

**FKOM/CE**

K

ACTUACIÓN ELÉCTRICA**ACTUACIÓN ELÉCTRICA CON BLOQUE DE SEGURIDAD**

d	24-240 V AC/DC		24-240 V AC/DC		24-240 V AC/DC		24-240 V AC/DC	
	Ref.	€ EPDM	Ref.	€ FKM	Ref.	€ EPDM	Ref.	€ FKM
50	FKME050E2D	780,28	FKME050F2D	927,86	FKME050E2BD	1.275,17	FKME050F2BD	1.422,71
63	FKME063E2D	797,41	FKME063F2D	953,66	FKME063E2BD	1.292,28	FKME063F2BD	1.448,53
75	FKME075E2D	1.063,24	FKME075F2D	1.236,82	FKME075E2BD	1.558,12	FKME075F2BD	1.731,70
90	FKME090E2D	1.093,05	FKME090F2D	1.274,43	FKME090E2BD	1.587,91	FKME090F2BD	1.769,32
110	FKME110E2D	1.125,44	FKME110F2D	1.313,24	FKME110E2BD	1.620,32	FKME110F2BD	1.808,11
125	FKME140E2D	1.583,99	FKME140F2D	1.840,45	FKME140E2BD	2.078,86	FKME140F2BD	2.335,34
140	FKME140E2D	1.583,99	FKME140F2D	1.840,45	FKME140E2BD	2.078,86	FKME140F2BD	2.335,34
160	FKME160E2D	1.855,47	FKME160F2D	2.114,63	FKME160E2BD	2.434,58	FKME160F2BD	2.693,74
200	FKME225E2D	2.158,76	FKME225F2D	2.496,85	FKME225E2BD	2.737,84	FKME225F2BD	3.075,96
225	FKME225E2D	2.158,76	FKME225F2D	2.496,85	FKME225E2BD	2.737,84	FKME225F2BD	3.075,96
250	FKME280E2D	3.901,89	FKME280F2D	5.412,52	FKME280E2BD	4.481,00	FKME280F2BD	5.991,62
280	FKME280E2D	3.901,89	FKME280F2D	5.412,52	FKME280E2BD	4.481,00	FKME280F2BD	5.991,62
315	FKME315E2D	4.123,41	FKME315F2D	5.770,15	FKME315E2BD	4.702,51	FKME315F2BD	6.349,26
355	FKME355E2D	9.878,57	FKME355F2D	13.385,36				
400	FKME400E2D	11.021,65	FKME400F2D	16.083,26				

Válvula de mariposa motorizada
cuerpo en PPGR y disco en PP-H
Actuación eléctrica

Bajo pedido podemos suministrar otros actuadores: VALPES, BELIMO...
[Bajo pedido también disponibles en 12 V AC/DC](#)



FKOM/CP

K

ACTUACIÓN NEUMÁTICA ALUMINIO

ACTUACIÓN NEUMÁTICA ALUMINIO CON ELECTROVÁLVULA, FINALES DE CARRERA (ELECTROMECÁNICOS) Y REGULADORES DE ESCAPE

d	DOBLE EFECTO		SIMPLE EFECTO		DOBLE EFECTO		SIMPLE EFECTO	
	Ref.	€	Ref.	€	Ref.	€	Ref.	€
50	FKMP050EDED	478,97	FKMP050ESED	559,59	FKMP050EDEFD	657,97	FKMP050ESEFD	748,04
63	FKMP063EDED	496,10	FKMP063ESED	576,72	FKMP063EDEFD	675,10	FKMP063ESEFD	765,15
75	FKMP075EDED	562,19	FKMP075ESED	681,29	FKMP075EDEFD	741,18	FKMP075ESEFD	869,72
90	FKMP090EDED	647,79	FKMP090ESED	754,62	FKMP090EDEFD	826,78	FKMP090ESEFD	943,08
110	FKMP110EDED	680,22	FKMP110ESED	1.082,37	FKMP110EDEFD	859,19	FKMP110ESEFD	1.270,81
125	FKMP140EDED	841,51	FKMP140ESED	1.445,88	FKMP140EDEFD	1.020,52	FKMP140ESEFD	1.634,32
140	FKMP140EDED	841,51	FKMP140ESED	1.445,88	FKMP140EDEFD	1.020,52	FKMP140ESEFD	1.634,32
160	FKMP160EDED	897,19	FKMP160ESED	1.501,53	FKMP160EDEFD	1.076,19	FKMP160ESEFD	1.689,98
200	FKMP225EDED	1.324,38	FKMP225ESED	2.153,84	FKMP225EDEFD	1.503,38	FKMP225ESEFD	2.342,28
225	FKMP225EDED	1.324,38	FKMP225ESED	2.153,84	FKMP225EDEFD	1.503,38	FKMP225ESEFD	2.342,28
250	FKMP280EDED	3.228,94	FKMP280ESED	4.987,41	FKMP280EDEFD	3.407,92	FKMP280ESEFD	5.175,87
280	FKMP280EDED	3.228,94	FKMP280ESED	4.987,41	FKMP280EDEFD	3.407,92	FKMP280ESEFD	5.175,87
315	FKMP315EDED	3.689,60	FKMP315ESED	6.117,36	FKMP315EDEFD	3.868,61	FKMP315ESEFD	6.305,82
355	FKMP355EDED	5.656,89	FKMP355ESED	7.486,40				
400	FKMP400EDED	6.321,22	FKMP400ESED	9.802,27				

50	FKMP050FDED	626,53	FKMP050FSED	707,13	FKMP050EDEFD	805,54	FKMP050FSEFD	895,60
63	FKMP063FDED	652,36	FKMP063FSED	732,97	FKMP063EDEFD	831,34	FKMP063FSEFD	921,41
75	FKMP075FDED	735,78	FKMP075FSED	854,86	FKMP075EDEFD	914,76	FKMP075FSEFD	1.043,29
90	FKMP090FDED	829,19	FKMP090FSED	936,03	FKMP090EDEFD	1.008,18	FKMP090FSEFD	1.124,49
110	FKMP110FDED	867,99	FKMP110FSED	1.270,14	FKMP110EDEFD	1.046,98	FKMP110FSEFD	1.458,59
125	FKMP140FDED	1.098,00	FKMP140FSED	1.702,36	FKMP140EDEFD	1.277,01	FKMP140FSEFD	1.890,82
140	FKMP140FDED	1.098,00	FKMP140FSED	1.702,36	FKMP140EDEFD	1.277,01	FKMP140FSEFD	1.890,82
160	FKMP160FDED	1.156,32	FKMP160FSED	1.760,68	FKMP160EDEFD	1.335,32	FKMP160FSEFD	1.949,13
200	FKMP225FDED	1.662,48	FKMP225FSED	2.491,94	FKMP225EDEFD	1.841,49	FKMP225FSEFD	2.680,39
225	FKMP225FDED	1.662,48	FKMP225FSED	2.491,94	FKMP225EDEFD	1.841,49	FKMP225FSEFD	2.680,39
250	FKMP280FDED	4.739,57	FKMP280FSED	6.498,05	FKMP280EDEFD	4.918,57	FKMP280FSEFD	6.686,50
280	FKMP280FDED	4.739,57	FKMP280FSED	6.498,05	FKMP280EDEFD	4.918,57	FKMP280FSEFD	6.686,50
315	FKMP315FDED	5.336,37	FKMP315FSED	7.764,10	FKMP315EDEFD	5.515,35	FKMP315FSEFD	7.952,56
355	FKMP355FDED	9.163,67	FKMP355FSED	10.993,18				
400	FKMP400FDED	11.382,81	FKMP400FSED	14.863,90				

Válvula de mariposa motorizada
 cuerpo en PPGR y disco en PP-H
 Actuación neumática

Las válvulas neumáticas se configuran NC (normalmente cerrada) de serie.
 La configuración NA (normalmente abierta) se debe especificar en el pedido



FKOM/CP

K

ACTUACIÓN NEUMÁTICA POLIAMIDA

ACTUACIÓN NEUMÁTICA POLIAMIDA CON ELECTROVÁLVULA, FINALES DE CARRERA (ELECTROMECÁNICOS) Y REGULADORES DE ESCAPE

d	DOBLE EFECTO		SIMPLE EFECTO		DOBLE EFECTO		SIMPLE EFECTO	
	Ref.	€	Ref.	€	Ref.	€	Ref.	€
50	FKMP050EDEP	574,41	FKMP050ESEP	719,98	FKMP050EDEFPP	808,54	FKMP050ESEFPP	954,13
63	FKMP063EDEP	591,53	FKMP063ESEP	737,10	FKMP063EDEFPP	825,67	FKMP063ESEFPP	971,24
75	FKMP075EDEP	625,72	FKMP075ESEP	771,28	FKMP075EDEFPP	859,86	FKMP075ESEFPP	1.005,44
90	FKMP090EDEP	741,44	FKMP090ESEP	800,77	FKMP090EDEFPP	975,59	FKMP090ESEFPP	1.034,92
110	FKMP110EDEP	773,85	FKMP110ESEP	1.007,38	FKMP110EDEFPP	1.008,00	FKMP110ESEFPP	1.241,52
125	FKMP140EDEP	898,32	FKMP140ESEP	1.399,62	FKMP140EDEFPP	1.132,46	FKMP140ESEFPP	1.633,76
140	FKMP140EDEP	898,32	FKMP140ESEP	1.399,62	FKMP140EDEFPP	1.132,46	FKMP140ESEFPP	1.633,76
160	FKMP160EDEP	1.117,78	FKMP160ESEP	1.455,28	FKMP160EDEFPP	1.351,92	FKMP160ESEFPP	1.689,43
200	FKMP225EDEP	1.307,78	FKMP225ESEP	2.004,29	FKMP225EDEFPP	1.541,93	FKMP225ESEFPP	2.238,43
225	FKMP225EDEP	1.307,78	FKMP225ESEP	2.004,29	FKMP225EDEFPP	1.541,93	FKMP225ESEFPP	2.238,43
250*	FKMP280EDEP	3.388,36	FKMP280ESEP	4.881,46	FKMP280EDEFPP	3.622,51	FKMP280ESEFPP	5.115,61
280*	FKMP280EDEP	3.388,36	FKMP280ESEP	4.881,46	FKMP280EDEFPP	3.622,51	FKMP280ESEFPP	5.115,61
315*	FKMP315EDEP	3.609,88	FKMP315ESEP	5.102,99	FKMP315EDEFPP	3.844,02	FKMP315ESEFPP	5.337,14
355	FKMP355EDEP	Consultar	FKMP355ESEP	Consultar				
400	FKMP400EDEP	Consultar	FKMP400ESEP	Consultar				

50	FKMP050FDEP	721,97	FKMP050FSEP	867,53	FKMP050FDEFPP	956,12	FKMP050FSEFPP	1.101,68
63	FKMP063FDEP	747,78	FKMP063FSEP	893,34	FKMP063FDEFPP	981,91	FKMP063FSEFPP	1.127,51
75	FKMP075FDEP	799,30	FKMP075FSEP	944,87	FKMP075FDEFPP	1.033,45	FKMP075FSEFPP	1.179,01
90	FKMP090FDEP	922,84	FKMP090FSEP	982,18	FKMP090FDEFPP	1.157,00	FKMP090FSEFPP	1.216,32
110	FKMP110FDEP	961,64	FKMP110FSEP	1.195,17	FKMP110FDEFPP	1.195,79	FKMP110FSEFPP	1.429,32
125	FKMP140FDEP	1.154,78	FKMP140FSEP	1.656,08	FKMP140FDEFPP	1.388,92	FKMP140FSEFPP	1.890,24
140	FKMP140FDEP	1.154,78	FKMP140FSEP	1.656,08	FKMP140FDEFPP	1.388,92	FKMP140FSEFPP	1.890,24
160	FKMP160FDEP	1.376,94	FKMP160FSEP	1.714,41	FKMP160FDEFPP	1.611,07	FKMP160FSEFPP	1.948,56
200	FKMP225FDEP	1.645,89	FKMP225FSEP	2.342,39	FKMP225FDEFPP	1.880,03	FKMP225FSEFPP	2.576,55
225	FKMP225FDEP	1.645,89	FKMP225FSEP	2.342,39	FKMP225FDEFPP	1.880,03	FKMP225FSEFPP	2.576,55
250*	FKMP280FDEP	4.898,98	FKMP280FSEP	6.392,09	FKMP280FDEFPP	5.133,13	FKMP280FSEFPP	6.626,24
280*	FKMP280FDEP	4.898,98	FKMP280FSEP	6.392,09	FKMP280FDEFPP	5.133,13	FKMP280FSEFPP	6.626,24
315*	FKMP315FDEP	5.256,62	FKMP315FSEP	6.749,73	FKMP315FDEFPP	5.490,77	FKMP315FSEFPP	6.983,87
355	FKMP355FDEP	Consultar	FKMP355FSEP	Consultar				
400	FKMP400FDEP	Consultar	FKMP400FSEP	Consultar				

Válvula de mariposa motorizada
 cuerpo en PPGR y disco en PP-H
 Actuación neumática

Las válvulas neumáticas se configuran NC (normalmente cerrada) de serie.
 La configuración NA (normalmente abierta) se debe especificar en el pedido
 * Actuadores de aluminio



INDUSTRIA

Sistema PP-H Socket Válvulas de solenoide



DK/CP NC

d	Modelo	DN	Ref. EPDM	€ EPDM
20	DKDM/CP NC	15	DKDMNC020E	226,42
25	DKDM/CP NC	20	DKDMNC025E	239,82
32	DKDM/CP NC	25	DKDMNC032E	291,84
40	DKDM/CP NC	32	DKDMNC040E	384,72
50	DKDM/CP NC	40	DKDMNC050E	435,09
63	DKDM/CP NC	50	DKDMNC063E	603,85
75	DKDM/CP NC	65	DKDMNC075E	363,52
90	VMDM/CP NC	80	VMDMNC090E	1.096,22
110	VMDM/CP NC	100	VMDMNC110E	1.362,91



VM/CP NC

Ref. FKM	€ FKM	Ref. PTFE	L € PTFE
DKDMNC020F	262,16	DKDMNC020P	277,82
DKDMNC025F	276,33	DKDMNC025P	290,48
DKDMNC032F	335,64	DKDMNC032P	353,13
DKDMNC040F	455,70	DKDMNC040P	474,84
DKDMNC050F	514,77	DKDMNC050P	535,63
DKDMNC063F	755,85	DKDMNC063P	733,72
DKDMNC075F	907,03	DKDMNC075P	880,47
VMDMNC090F	1.445,83	VMDMNC090P	1.259,18
VMDMNC110F	1.697,95	VMDMNC110P	1.516,74

Válvula neumática **NORMALMENTE CERRADA.**
M-M para soldar socket.



DK/CP NO

d	Modelo	DN	Ref. EPDM	€ EPDM
20	DKDM/CP NO	15	DKDMNO020E	188,84
25	DKDM/CP NO	20	DKDMNO025E	202,25
32	DKDM/CP NO	25	DKDMNO032E	252,75
40	DKDM/CP NO	32	DKDMNO040E	267,83
50	DKDM/CP NO	40	DKDMNO050E	312,96
63	DKDM/CP NO	50	DKDMNO063E	400,97
75	DKDM/CP NO	65	DKDMNO075E	481,15
90	VMDM/CP NO	80	VMDMNO090E	760,21
110	VMDM/CP NO	100	VMDMNO110E	1.081,54



VM/CP NO

Ref. FKM	€ FKM	Ref. PTFE	L € PTFE
DKDMNO020F	224,61	DKDMNO020P	240,25
DKDMNO025F	238,77	DKDMNO025P	252,93
DKDMNO032F	318,46	DKDMNO032P	337,99
DKDMNO040F	362,73	DKDMNO040P	387,61
DKDMNO050F	415,65	DKDMNO050P	443,75
DKDMNO063F	572,11	DKDMNO063P	567,26
DKDMNO075F	686,55	DKDMNO075P	680,71
VMDMNO090F	1.168,03	VMDMNO090P	950,25
VMDMNO110F	1.522,43	VMDMNO110P	1.144,56

Válvula neumática **NORMALMENTE ABIERTA.**
M-M para soldar socket.



DK/CP DE

d	Modelo	DN	Ref. EPDM	€ EPDM
20	DKDMA/CP DE	15	DKDMA020E	151,29
25	DKDMA/CP DE	20	DKDMA025E	164,69
32	DKDMA/CP DE	25	DKDMA032E	221,79
40	DKDMA/CP DE	32	DKDMA040E	243,48
50	DKDMA/CP DE	40	DKDMA050E	284,51
63	DKDMA/CP DE	50	DKDMA063E	364,52
75	DKDMA/CP DE	65	DKDMA075E	437,41
90	VMDMA/CP DE	80	VMDMA090E	933,16
110	VMDMA/CP DE	100	VMDMA110E	1.247,58



VM/CP DE

Ref. FKM	€ FKM	Ref. PTFE	L € PTFE
DKDMA020F	187,03	DKDMA020P	202,68
DKDMA025F	201,20	DKDMA025P	215,35
DKDMA032F	283,20	DKDMA032P	301,57
DKDMA040F	329,75	DKDMA040P	352,37
DKDMA050F	377,85	DKDMA050P	403,42
DKDMA063F	520,10	DKDMA063P	515,68
DKDMA075F	660,24	DKDMA075P	618,83
VMDMA090F	1.340,99	VMDMA090P	1.123,19
VMDMA110F	1.566,22	VMDMA110P	1.352,92

Válvula neumática **DOBLE EFECTO**
M-M para soldar socket.



DK/CP NC

d	Modelo	DN	Ref. EPDM	€ EPDM	Ref. FKM	€ FKM	Ref. PTFE	L € PTFE
20	DKUIM/CP NC	15	DKUIMNC020E	236,85	DKUIMNC020F	273,37	DKUIMNC020P	289,03
25	DKUIM/CP NC	20	DKUIMNC025E	251,01	DKUIMNC025F	273,37	DKUIMNC025P	301,67
32	DKUIM/CP NC	25	DKUIMNC032E	305,83	DKUIMNC032F	349,65	DKUIMNC032P	367,19
40	DKUIM/CP NC	32	DKUIMNC040E	399,61	DKUIMNC040F	470,57	DKUIMNC040P	490,73
50	DKUIM/CP NC	40	DKUIMNC050E	451,23	DKUIMNC050F	530,87	DKUIMNC050P	551,73
63	DKUIM/CP NC	50	DKUIMNC063E	627,56	DKUIMNC063F	761,21	DKUIMNC063P	757,41

Válvula neumática **NORMALMENTE CERRADA.**

Con enlaces H-H para soldar socket.



DK/CP NO

d	Modelo	DN	Ref. EPDM	€ EPDM	Ref. FKM	€ FKM	Ref. PTFE	L € PTFE
20	DKUIM/CP NO	15	DKUIMNO020E	199,29	DKUIMNO020F	235,80	DKUIMNO020P	251,46
25	DKUIM/CP NO	20	DKUIMNO025E	213,46	DKUIMNO025F	235,80	DKUIMNO025P	264,09
32	DKUIM/CP NO	25	DKUIMNO032E	267,96	DKUIMNO032F	326,57	DKUIMNO032P	298,32
40	DKUIM/CP NO	32	DKUIMNO040E	287,04	DKUIMNO040F	381,95	DKUIMNO040P	406,79
50	DKUIM/CP NO	40	DKUIMNO050E	333,72	DKUIMNO050F	436,45	DKUIMNO050P	464,52
63	DKUIM/CP NO	50	DKUIMNO063E	432,77	DKUIMNO063F	602,67	DKUIMNO063P	599,00

Válvula neumática **NORMALMENTE ABIERTA.**

Con enlaces H-H para soldar socket.



DK/CP DE

d	Modelo	DN	Ref. EPDM	€ EPDM	Ref. FKM	€ FKM	Ref. PTFE	L € PTFE
20	DKUIM/CP DE	15	DKUIMDA020E	161,72	DKUIMDA020F	198,23	DKUIMDA020P	213,87
25	DKUIM/CP DE	20	DKUIMDA025E	175,88	DKUIMDA025F	198,23	DKUIMDA025P	226,53
32	DKUIM/CP DE	25	DKUIMDA032E	236,12	DKUIMDA032F	290,42	DKUIMDA032P	315,89
40	DKUIM/CP DE	32	DKUIMDA040E	260,94	DKUIMDA040F	347,21	DKUIMDA040P	369,81
50	DKUIM/CP DE	40	DKUIMDA050E	303,37	DKUIMDA050F	396,77	DKUIMDA050P	422,29
63	DKUIM/CP DE	50	DKUIMDA063E	393,42	DKUIMDA063F	547,88	DKUIMDA063P	544,55

Válvula neumática **DOBLE EFECTO.**

Con enlaces H-H para soldar socket.



INDUSTRIA

Sistema PP-H Socket

Válvulas de membrana actuadas

**DK/CP NC****VM/CP NC**

d	Modelo	DN	Ref. EPDM	€ EPDM	Ref. FKM	€ FKM	Ref. PTFE	L € PTFE
20	DKOM/CP NC	15	DKOMNC020E	260,38	DKOMNC020F	296,13	DKOMNC020P	311,79
25	DKOM/CP NC	20	DKOMNC025E	275,82	DKOMNC025F	312,30	DKOMNC025P	326,45
32	DKOM/CP NC	25	DKOMNC032E	335,56	DKOMNC032F	379,38	DKOMNC032P	396,91
40	DKOM/CP NC	32	DKOMNC040E	442,39	DKOMNC040F	513,39	DKOMNC040P	532,56
50	DKOM/CP NC	40	DKOMNC050E	500,36	DKOMNC050F	580,04	DKOMNC050P	600,88
63	DKOM/CP NC	50	DKOMNC063E	694,44	DKOMNC063F	846,45	DKOMNC063P	824,31
75	DKOM/CP NC	65	DKOMNC075E	833,34	DKOMNC075F	1.015,74	DKOMNC075P	989,17
90	VMOM/CP NC	80	VMOMNC090E	1.260,64	VMOMNC090F	1.610,26	VMOMNC090P	1.423,62
110	VMOM/CP NC	100	VMOMNC110E	1.567,33	VMOMNC110F	1.901,82	VMOMNC110P	1.720,98

Válvula neumática **NORMALMENTE CERRADA.**

Disponibles con bridas ANSI 150 libras al mismo precio

Con bridas DIN.

**DK/CP NO****VM/CP NO**

d	Modelo	DN	Ref. EPDM	€ EPDM	Ref. FKM	€ FKM	Ref. PTFE	L € PTFE
20	DKOM/CP NO	15	DKOMNO020E	222,80	DKOMNO020F	258,57	DKOMNO020P	274,22
25	DKOM/CP NO	20	DKOMNO025E	238,24	DKOMNO025F	274,74	DKOMNO025P	288,88
32	DKOM/CP NO	25	DKOMNO032E	302,49	DKOMNO032F	368,19	DKOMNO032P	328,38
40	DKOM/CP NO	32	DKOMNO040E	331,31	DKOMNO040F	426,21	DKOMNO040P	451,08
50	DKOM/CP NO	40	DKOMNO050E	384,74	DKOMNO050F	487,44	DKOMNO050P	515,55
63	DKOM/CP NO	50	DKOMNO063E	500,59	DKOMNO063F	671,77	DKOMNO063P	666,90
75	DKOM/CP NO	65	DKOMNO075E	600,71	DKOMNO075F	806,12	DKOMNO075P	800,28
90	VMOM/CP NO	80	VMOMNO090E	924,64	VMOMNO090F	1.332,43	VMOMNO090P	1.114,67
110	VMOM/CP NO	100	VMOMNO110E	1.231,06	VMOMNO110F	1.573,70	VMOMNO110P	1.347,47

Válvula neumática **NORMALMENTE ABIERTA.**

Disponibles con bridas ANSI 150 libras al mismo precio

Con bridas DIN.

**DK/CP DE****VM/CP DE**

d	Modelo	DN	Ref. EPDM	€ EPDM	Ref. FKM	€ FKM	Ref. PTFE	L € PTFE
20	DKOM/CP DE	15	DKOMDA020E	185,24	DKOMDA020F	221,01	DKOMDA020P	236,65
25	DKOM/CP DE	20	DKOMDA025E	200,67	DKOMDA025F	237,17	DKOMDA025P	251,32
32	DKOM/CP DE	25	DKOMDA032E	268,64	DKOMDA032F	330,05	DKOMDA032P	298,54
40	DKOM/CP DE	32	DKOMDA040E	301,21	DKOMDA040F	387,47	DKOMDA040P	410,07
50	DKOM/CP DE	40	DKOMDA050E	349,76	DKOMDA050F	443,13	DKOMDA050P	468,68
63	DKOM/CP DE	50	DKOMDA063E	455,08	DKOMDA063F	610,70	DKOMDA063P	606,27
75	DKOM/CP DE	65	DKOMDA075E	546,10	DKOMDA075F	732,84	DKOMDA075P	727,53
90	VMOM/CP DE	80	VMOMDA090E	1.097,60	VMOMDA090F	1.505,41	VMOMDA090P	1.287,64
110	VMOM/CP DE	100	VMOMDA110E	1.397,11	VMOMDA110F	1.777,97	VMOMDA110P	1.556,57

Válvula neumática **DOBLE EFECTO.**

Disponibles con bridas ANSI 150 libras al mismo precio

Con bridas DIN.

CMDM/CP NC *M-M para fusión socket*
CMIM/CP NC *H-H para fusión socket*
CMUIM/CP NC *H-H enlaces fusión socket*
CMFM/CP NC *H-H roscar.*

L

d-Rh	Ref. EPDM	DN	€ EPDM	€ FKM	€ PTFE
20	CMDMNC020E	15	103,40	136,72	154,23
16	CMIMNC016E	12	99,01	115,68	124,44
20	CMIMNC020E	15	99,01	115,68	124,44
20-1/2"	CMUIMNC020E	15	145,45	164,72	(A)173,49
3/8"	CMFMNC038E	12	99,01	115,68	124,44
1/2"	CMFMNC012E	15	99,01	115,68	124,44

Válvula de membrana compacta neumática
NORMALMENTE CERRADA.

Código en FKM termina en "F" en lugar de "E"
Código en PTFE termina en "P" en lugar de "E"
(A) = Juntas en FKM

CMDM/CP NO *M-M para fusión socket*
CMIM/CP NO *H-H para fusión socket*
CMUIM/CP NO *H-H enlaces fusión socket*
CMFM/CP NO *H-H roscar.*

L

d-Rh	Ref. EPDM	DN	€ EPDM	€ FKM	€ PTFE
20	CMDMNO020E	15	102,52	134,07	152,47
16	CMIMNO016E	12	98,14	113,92	122,67
20	CMIMNO020E	15	98,14	113,92	122,67
20-1/2"	CMUIMNO020E	15	143,72	162,08	(A)171,75
3/8"	CMFMNO038E	12	98,14	113,92	122,67
1/2"	CMFMNO012E	15	98,14	113,92	122,67

Válvula de membrana compacta neumática
NORMALMENTE ABIERTA.

Código en FKM termina en "F" en lugar de "E"
Código en PTFE termina en "P" en lugar de "E"
(A) = Juntas en FKM

CMDM/CP DE *M-M para fusión socket*
CMIM/CP DE *H-H para fusión socket*
CMUIM/CP DE *H-H enlaces fusión socket*
CMFM/CP DE *H-H roscar.*

L

d-Rh	Ref. EPDM	DN	€ EPDM	€ FKM	€ PTFE
20	CMDMDA020E	15	102,52	134,07	152,47
16	CMIMDA016E	12	98,14	113,92	122,67
20	CMIMDA020E	15	98,14	113,92	122,67
20-1/2"	CMUIMDA020E	15	143,72	162,08	(A)171,75
3/8"	CMFMDA038E	12	98,14	113,92	122,67
1/2"	CMFMDA012E	15	98,14	113,92	122,67

Válvula de membrana compacta neumática
DOBLE EFECTO.

Código en FKM termina en "F" en lugar de "E"
Código en PTFE termina en "P" en lugar de "E"
(A) = Juntas en FKM

**DKBDM/CP NC**

d	Ref. EPDM	DN	PN	L € EPDM
20	DKBDMNC020E	15	6	210,65
25	DKBDMNC025E	20	6	223,12
32	DKBDMNC032E	25	6	275,82
40	DKBDMNC040E	32	6	343,43
50	DKBDMNC050E	40	6	359,10
63	DKBDMNC063E	50	6	498,32
75	DKBDMNC075E	65	6	597,99

Válvula de membrana neumática
Normalmente Cerrada.
M-M soldar socket

Actuador a pistón

DKBUIM/CP NC

d	Ref. EPDM	DN	PN	L € EPDM
20	DKBUIMNC020E	15	6	220,37
25	DKBUIMNC025E	20	6	233,55
32	DKBUIMNC032E	25	6	289,11
40	DKBUIMNC040E	32	6	356,72
50	DKBUIMNC050E	40	6	372,38
63	DKBUIMNC063E	50	6	517,90

Válvula de membrana neumática
Normalmente Cerrada.

Actuador a pistón

Con enlaces H-H para soldar socket

**DKBOM/CP NC**

d	Ref. EPDM	DN	PN	L € EPDM
20	DKBOMNC020E	15	6	242,24
25	DKBOMNC025E	20	6	256,61
32	DKBOMNC032E	25	6	323,19
40	DKBOMNC040E	32	6	405,86
50	DKBOMNC050E	40	6	424,35
63	DKBOMNC063E	50	6	588,90
75	DKBOMNC075E	65	6	765,58

Válvula de membrana neumática
Normalmente Cerrada.

Con bridas DIN

Actuador a pistón

**DKBOAM/CP NC**

d	Ref. EPDM	DN	PN	L € EPDM
1/2"	DKBOAMNC012E	15	6	242,24
3/4"	DKBOAMNC034E	20	6	256,61
1"	DKBOAMNC100E	25	6	323,19
1 1/4"	DKBOAMNC114E	32	6	405,86
1 1/2"	DKBOAMNC112E	40	6	424,35
2"	DKBOAMNC200E	50	6	585,29
2 1/2"	DKBOAMNC212E	65	6	765,58

Válvula de membrana neumática
Normalmente Cerrada.

Con bridas ANSI 150 lbs

Actuador a pistón



VSF

d	Ref. EPDM	DN	PN	L	
				€ EPDM	€ PTFE
16	VSFBM016E	10	10	281,58	319,43
20	VSFBM020E	15	10	331,57	340,96
25	VSFBM025E	20	10	365,53	390,74
32	VSFBM032E	25	10	386,83	408,43
40	VSFBM040E	32	10	488,21	522,14
50	VSFBM050E	40	10	813,21	849,83
63	VSFBM063E	50	10	1.092,18	1.103,39

Válvula de sobrepresión-alivio.
M-M para soldadura a testa.

Código en PTFE termina en "P"
en lugar de "E"
Rango de calibración: 0,5 - 10 bars



VCP

d	Ref. EPDM	DN	PN	L	
				€ EPDM	€ PTFE
16	VCPBM016E	10	10	257,07	278,81
20	VCPBM020E	15	10	257,07	278,81
25	VCPBM025E	20	10	343,71	368,05
32	VCPBM032E	25	10	369,21	398,97
40	VCPBM040E	32	10	470,76	495,06
50	VCPBM050E	40	10	726,48	753,15
63	VCPBM063E	50	10	950,46	972,24

Válvula retenedora de presión.
M-M para soldadura a testa.

Código en PTFE termina en "P"
en lugar de "E"
Rango de calibración: 0,5 - 10 bars



VPR

d	Ref. EPDM	DN	PN	L	
				€ EPDM	€ FKM
16	VPRBM016E	10	10	717,99	744,34
20	VPRBM020E	15	10	717,99	744,34
25	VPRBM025E	20	10	916,33	956,45
32	VPRBM032E	25	10	916,33	956,45
40	VPRBM040E	32	10	1.103,19	1.152,93
50	VPRBM050E	40	10	1.103,19	1.152,93
63	VPRBM063E	50	10	1.560,00	1.608,81

Válvula reductora de presión.
M-M para soldadura a testa.

Código en FKM termina en "F"
en lugar de "E"
Rango de calibración: 0,5 - 9 bars



MANGUITO

V

d	Ref.	Para válvulas	€
16	ENDIM016	VKD-VKR-TKD-SR-RV-VR	9,41
20	ENDIM020	VKD-VKR-TKD-SR-RV-VR	9,41
25	ENDIM025	VKD-VKR-TKD-SR-RV-VR	11,18
32	ENDIM032	VKD-VKR-TKD-SR-RV-VR	12,36
40	ENDIM040	VKD-VKR-TKD-SR-RV-VR	15,28
50	ENDIM050	VKD-VKR-TKD-SR-RV-VR	17,58
63	ENDIM063	VKD-VKR-TKD-SR-RV-VR	22,27
75	ENDIM075	VKD	52,76
90	ENDIM090	VKD	57,59
110	ENDIM110	VKD	79,96

Conector final en PP-H.
H para soldar socket.



MANGUITO

V

Rh	Ref.	Para válvulas	€
3/8"	ENDFM038	VKD-VKR-TKD-SR-RV-VR	9,41
1/2"	ENDFM012	VKD-VKR-TKD-SR-RV-VR	9,41
3/4"	ENDFM034	VKD-VKR-TKD-SR-RV-VR	11,18
1"	ENDFM100	VKD-VKR-TKD-SR-RV-VR	12,36
1 1/4"	ENDFM114	VKD-VKR-TKD-SR-RV-VR	15,28
1 1/2"	ENDFM112	VKD-VKR-TKD-SR-RV-VR	17,58
2"	ENDFM200	VKD-VKR-TKD-SR-RV-VR	22,27

Conector final en PP-H.
H rosca gas.



MANGUITO

V

Rh	Ref.	Para válvulas	€
1/2"	ENDNM012	VKD-VKR-TKD-SR-RV-VR	9,41
3/4"	ENDNM034	VKD-VKR-TKD-SR-RV-VR	11,18
1"	ENDNM100	VKD-VKR-TKD-SR-RV-VR	12,36
1 1/4"	ENDNM114	VKD-VKR-TKD-SR-RV-VR	15,28
1 1/2"	ENDNM112	VKD-VKR-TKD-SR-RV-VR	17,58
2"	ENDNM200	VKD-VKR-TKD-SR-RV-VR	22,27

Conector final en PP-H.
H rosca NPT.



MANGUITO

V

d	Ref.	Para válvulas	€
20	ENDDM020	VKD-VKR-TKD-SR-RV-VR	9,41
25	ENDDM025	VKD-VKR-TKD-SR-RV-VR	11,18
32	ENDDM032	VKD-VKR-TKD-SR-RV-VR	12,36
40	ENDDM040	VKD-VKR-TKD-SR-RV-VR	15,28
50	ENDDM050	VKD-VKR-TKD-SR-RV-VR	17,58
63	ENDDM063	VKD-VKR-TKD-SR-RV-VR	22,27
75	ENDDM075	VKD	52,76
90	ENDDM090	VKD	57,59
110	ENDDM110	VKD	79,96

Conector final en PP-H.
M para soldar socket.



Q-BBM/L

T1

d	Ref.	Para válvulas de membrana	€
20	QBBML11020	CM-DK	4,43
25	QBBML11025	CM-DK	5,35
32	QBBML11032	CM-DK	6,57
40	QBBML11040	CM-DK	8,53
50	QBBML11050	CM-DK	9,01
63	QBBML11063	CM-DK	12,96

Conector final en PP SDR11.
Para soldar a testa o electrofusión.



CVDM

V

d	Ref.	Para válvulas	€
20	CVDM11020	VKD-VKR-TKD-SR-RV-VR	4,44
25	CVDM11025	VKD-VKR-TKD-SR-RV-VR	5,21
32	CVDM11032	VKD-VKR-TKD-SR-RV-VR	6,40
40	CVDM11040	VKD-VKR-TKD-SR-RV-VR	7,98
50	CVDM11050	VKD-VKR-TKD-SR-RV-VR	10,35
63	CVDM11063	VKD-VKR-TKD-SR-RV-VR	13,32
75	CVDM11075	VKD	26,94
90	CVDM11090	VKD	33,86
110	CVDM11110	VKD	41,02

Conector final en PP-H SDR11.
Para soldar a testa o electrofusión.

Accesorios

Sistema PP-H testa / butt welding

INDUSTRIA





Sistema PP-H Testa





GBM

d	Ref. PN6	T1	
		€ PN6 SDR 17,6	€ PN10 SDR 11
20			GBM11020 3,28
25			GBM11025 3,41
32			GBM11032 3,53
40			GBM11040 4,58
50	GBM17050 5,50		GBM11050 5,77
63	GBM17063 7,61		GBM11063 8,26
75	GBM17075 11,15		GBM11075 11,37
90	GBM17090 14,55		GBM11090 16,55
110	GBM17110 30,63		GBM11110 31,46
125	GBM17125 38,96		GBM11125 44,33
140	GBM17140 56,58		GBM11140 59,25
160	GBM17160 60,67		GBM11160 72,19
180	GBM17180 77,14		GBM11180 85,47
200	GBM17200 95,53		GBM11200 127,38
225	GBM17225 117,75		GBM11225 151,92
250	GBM17250 198,86		GBM11250 292,46
280	GBM17280 258,43		GBM11280 380,26
315	GBM17315 357,03		GBM11315 524,97
355	GBM17355 810,22		GBM11355 1.099,65
400	GBM17400 1.128,23		GBM11400 1.510,10
450	GBM17450 1.453,83		GBM11450 1.953,21
500	GBM17500 1.834,54		GBM11500 2.519,64

Codo 90°.

M-M para soldar a testa.



HBM

d	Ref. PN6	T1	
		€ PN6 SDR 17,6	€ PN10 SDR 11
20			HBM11020 3,08
25			HBM11025 3,21
32			HBM11032 3,34
40			HBM11040 4,31
50	HBM17050 4,32		HBM11050 5,42
63	HBM17063 7,19		HBM11063 7,79
75	HBM17075 10,50		HBM11075 10,74
90	HBM17090 13,71		HBM11090 15,54
110	HBM17110 28,87		HBM11110 29,61
125	HBM17125 36,68		HBM11125 41,72
140	HBM17140 53,28		HBM11140 55,78
160	HBM17160 58,76		HBM11160 67,96
180	HBM17180 94,51		HBM11180 105,13
200	HBM17200 129,30		HBM11200 143,67
225	HBM17225 154,26		HBM11225 171,27
250	HBM17250 298,51		HBM11250 331,70
280	HBM17280 450,77		HBM11280 500,85
315	HBM17315 560,96		HBM11315 626,65

Codo 45°.

M-M para soldar a testa.

CBM

d	Ref. PN6	T1	
		€ PN6 SDR 17,6	€ PN10 SDR 11
20			CBM11020 4,26
25			CBM11025 4,67
32			CBM11032 5,90
40			CBM11040 7,34
50			CBM11050 9,57
63	CBM17063 12,63		CBM11063 12,63
75	CBM17075 19,55		CBM11075 19,55
90	CBM17090 29,68		CBM11090 29,68
110	CBM17110 40,23		CBM11110 40,23
125	CBM17125 50,19		CBM11125 43,48
140	CBM17140 54,38		CBM11140 54,38
160	CBM17160 60,96		CBM11160 60,96
180	CBM17180 79,24		CBM11180 79,24

Tapón.

M para soldar a testa.

d	Ref. PN6	T1	
		€ PN6 SDR 17,6	€ PN10 SDR 11
200	CBM17200 98,69		CBM11200 98,69
225	CBM17225 117,82		CBM11225 117,82
250	CBM17250 150,21		CBM11250 150,21
280	CBM17280 212,86		CBM11280 212,86
315	CBM17315 284,25		CBM11315 284,25
355	CBM17355 367,46		CBM11355 312,80
400	CBM17400 454,91		CBM11400 428,82
450	CBM17450 626,35		CBM11450 648,56
500	CBM17500 749,91		CBM11500 824,72
560	CBM17560 956,12		
630	CBM17630 1.450,57		
710	CBM17710 2.189,40		
800	CBM17800 3.432,51		

**QBM**

d	€ PN6		T1	
	Ref. PN6	SDR 17,6	Ref. PN10	€ PN10 SDR 11
20			QBM11020	2,97
25			QBM11025	2,97
32			QBM11032	3,51
40	QBM17040	4,04	QBM11040	4,20
50	QBM17050	4,74	QBM11050	5,14
63	QBM17063	5,77	QBM11063	6,42
75	QBM17075	6,81	QBM11075	7,61
90	QBM17090	9,98	QBM11090	10,90
110	QBM17110	12,69	QBM11110	14,03
125	QBM17125	15,58	QBM11125	16,91
140	QBM17140	18,13	QBM11140	19,75
160	QBM17160	22,41	QBM11160	24,92
180	QBM17180	32,73	QBM11180	38,67
200	QBM17200	40,92	QBM11200	42,54
225	QBM17225	45,85	QBM11225	47,42
250	QBM17250	65,53	QBM11250	71,98
280	QBM17280	71,98	QBM11280	78,63
315	QBM17315	87,88	QBM11315	92,65
355	QBM17355	215,73	QBM11355	235,60
400	QBM17400	435,96	QBM11400	464,09
450	QBM17450	506,39	QBM11450	535,82
500	QBM17500	624,28	QBM11500	678,54
560	QBM17560	747,27	QBM11560	880,30
630	QBM17630	865,43	QBM11630	1.048,60
710	QBM17710	1.271,01		
800	QBM17800	1.843,23		
900	QBM17900	3.386,06		
1.000	QBM171000	5.551,29		

Manguito portabridas.

M para soldar a testa.

**TBM**

d	€ PN6		T1	
	Ref. PN6	SDR 17,6	Ref. PN10	€ PN10 SDR 11
20			TBM11020	2,62
25			TBM11025	2,62
32			TBM11032	3,30
40			TBM11040	5,25
50	TBM17050	8,32	TBM11050	7,11
63	TBM17063	8,53	TBM11063	10,99
75	TBM17075	17,43	TBM11075	22,13
90	TBM17090	24,88	TBM11090	33,05
110	TBM17110	41,29	TBM11110	48,55
125	TBM17125	57,22	TBM11125	66,85
140	TBM17140	67,53	TBM11140	84,70
160	TBM17160	126,99	TBM11160	142,48
180	TBM17180	155,98	TBM11180	182,61
200	TBM17200	213,02	TBM11200	261,66
225	TBM17225	250,07	TBM11225	311,26
250	TBM17250	331,91	TBM11250	395,97
280	TBM17280	375,13	TBM11280	535,36
315	TBM17315	498,94	TBM11315	760,50
355	TBM17355	1.074,42	TBM11355	1.272,82
400	TBM17400	1.468,52	TBM11400	1.900,52
450	TBM17450	2.013,01	TBM11450	2.475,04
500	TBM17500	2.590,53	TBM11500	3.163,21

Te 90°.

M-M-M para soldar a testa.



TRBM

T1

d x dr	Ref. PN6	€ PN6 SDR 176	Ref. PN10	€ PN10 SDR 11	d x dr	Ref. PN6	€ PN6 SDR 176	Ref. PN10	€ PN10 SDR 11
63 x 50*	TRBM17063050	20,50	TRBM11063050	22,16	180 x 63	TRBM17180063	207,78	TRBM11180063	242,94
75 x 32*			TRBM11075032	34,71	180 x 75	TRBM17180075	207,78	TRBM11180075	242,94
75 x 50*	TRBM17075050	31,06	TRBM11075050	34,71	180 x 90*	TRBM17180090	250,80	TRBM11180090	277,89
75 x 63*	TRBM17075063	31,59	TRBM11075063	35,38	180 x 110*	TRBM17180110	214,13	TRBM11180110	277,89
90 x 32			TRBM11090032	43,89	180 x 125	TRBM17180125	214,13	TRBM11180125	250,73
90 x 50			TRBM11090050	45,09	180 x 160*	TRBM17180160	250,80	TRBM11180160	277,89
90 x 63*	TRBM17090063	44,19	TRBM11090063	49,43	200 x 63*	TRBM17200063	283,53	TRBM11200063	348,35
90 x 75*	TRBM17090075	44,57	TRBM11090075	49,83	200 x 90*	TRBM17200090	286,71	TRBM11200090	352,05
110 x 32			TRBM11110032	64,76	200 x 110*	TRBM17200110	289,87	TRBM11200110	355,67
110 x 50			TRBM11110050	66,11	200 x 125*	TRBM17200125	292,81	TRBM11200125	359,62
110 x 63*	TRBM17110063	65,53	TRBM11110063	73,32	200 x 160*	TRBM17200160	296,49	TRBM11200160	363,52
110 x 75*	TRBM17110075	65,53	TRBM11110075	73,32	225 x 75*	TRBM17225075	423,24	TRBM11225075	469,79
110 x 90*	TRBM17110090	67,11	TRBM11110090	74,33	225 x 90*	TRBM17225090	423,24	TRBM11225090	469,79
125 x 63			TRBM11125063	92,49	225 x 110*	TRBM17225110	424,67	TRBM11225110	471,70
125 x 90*			TRBM11125090	101,97	225 x 125	TRBM17225125	340,48	TRBM11225125	422,97
125 x 110*	TRBM17125110	91,02	TRBM11125110	101,97	225 x 160*	TRBM17225160	425,83	TRBM11225160	473,36
140 x 63	TRBM17140063	90,08	TRBM11140063	116,04	225 x 180*	TRBM17225180	426,57	TRBM11225180	474,99
140 x 75	TRBM17140075	90,50	TRBM11140075	116,04	250 x 110	TRBM17250110	446,67	TRBM11250110	558,24
140 x 90	TRBM17140090	91,96	TRBM11140090	117,88	250 x 160	TRBM17250160	455,75	TRBM11250160	569,75
140 x 110	TRBM17140110	93,85	TRBM11140110	117,88	315 x 110			TRBM11315110	1.261,08
160 x 63*	TRBM17160063	180,37	TRBM11160063	200,49	315 x 225			TRBM11315225	1.318,43
160 x 75*	TRBM17160075	185,89	TRBM11160075	202,17	315 x 250			TRBM11315250	1.318,43
160 x 90*	TRBM17160090	185,89	TRBM11160090	202,17					
160 x 110*	TRBM17160110	187,64	TRBM11160110	202,17					
160 x 125	TRBM17160125	175,00	TRBM11160125	195,66					

Te a 90° reducida.

M-M para soldar a testa.

* Espigots LARGOS

**QBM FK**

T1

d Válvula	d Tubo	Ref. PN6	€ PN6 SDR 176	Ref. PN10	€ PN10 SDR 11
50	50	QPM17050	5,95	QPM11050	6,46
63	63	QPM17063	7,25	QPM11063	7,99
75	75	QPM17075	8,60	QPM11075	9,63
90	90	QPM17090	12,55	QPM11090	13,72
110	110	QPM17110	15,95	QPM11110	18,21
140	125	QPM17125	19,50	QPM11125	21,22
160	140	QPM17140	22,67	QPM11140	24,79
160	160	QPM17160	28,10	QPM11FK160	48,03
160	180	QPM17180	43,51	QPM11180	51,33
225	200	QBM17FK200	78,59	QPM11FK200	81,81
225	225	QPM17225	57,34	QPM11FK225	91,13
280	250	QPM17250	82,00	QPM11FK250	138,34
280	280	QBM17FK280	133,66	QPM11FK280	151,11
315	315	QBM17FK315	168,92	QPM11FK315	178,05
355	350	QBM17FK355	400,85	QPM11FK355	438,46
400	400	QBM17FK400	758,00	QPM11FK400	816,42

Manguito portabridas

para válvulas de mariposa FE/FK.

M para soldar a testa.

**QBAM**

T1

d	Ref. PN6	€ PN6 SDR 176	Ref. PN10	€ PN10 SDR 11
¾"			QBAM11034	3,92
1"			QBAM11100	4,64
1¼"	QBAM17114	5,32	QBAM11114	5,53
1½"	QBAM17112	6,25	QBAM11112	6,79
3"	QBAM17300	13,20	QBAM11300	14,36

Manguito portabridas largo

ANSI 150 lbs.

M para soldar a testa.

**ODB**

T1

d	Ref.	DN	PN	€
20	ODB020	15	16	7,15
25	ODB025	20	16	7,86
32	ODB032	25	16	10,13
40	ODB040	32	16	12,28
50	ODB050	40	16	14,36
63	ODB063	50	16	17,85
75	ODB075	65	16	19,73
90	ODB090	80	16	23,50
110	ODB110	100	16	28,36
125	ODB125	100	16	28,36
140	ODB140	125	16	42,41
140	ODB140DN125	*125	16	43,72
160	ODB160	150	16	43,19
180	ODB180	150	16	49,53
200	ODB200	200	10	64,88
225	ODB225	200	10	64,88
225	ODB225DN200	*200	10	89,82
250	ODB250	250	10	81,21
280	ODB280	250	10	82,73
280	ODB280DN250	*250	10	93,00
315	ODB315	300	10	126,32
315	ODB315DN300	*300	10	136,21
355	ODB355	350	10	236,49
400	ODB400	400	10	341,28
450	ODB450	450	10	610,21
500	ODB500	500	10	610,21
560	ODB560	600	10	827,52
630	ODB630	600	10	827,52

Brida loca PP con alma de acero
DIN 2501 DIN 16962/16963.

* Para portabridas PVC-U

A partir de Ø 75 no utilizar
con portabridas socket
(sólo testa)

**OAB**

T1

d	Ref.	DN	€
½"	OAB012	15	9,56
¾"	OAB034	20	11,91
1"	OAB100	25	14,03
1¼"	OAB114	32	16,18
1½"	OAB112	40	20,16
2"	OAB200	50	25,08
2½"	OAB212	65	30,96
3"	OAB300	80	36,31
4"	OAB400	100	47,36
6"	OAB600	150	89,46
8"	OAB800	200	129,44
10"	OAB810	250	166,69
12"	OAB812	300	257,13
14"	OAB814	350	485,15
16"	OAB816	400	591,55

Brida loca PP con alma de acero
ANSI 150 lbs.

A partir de Ø 75 no utilizar
con portabridas socket
(sólo testa)

**ODBC**

T1

d	Ref.	DN	PN	€
20	ODBC020	15	16	54,62
25	ODBC025	20	16	55,47
32	ODBC032	25	16	56,88
40	ODBC040	32	16	60,92
50	ODBC050	40	16	69,01
63	ODBC063	50	16	75,12
75	ODBC075	65	16	88,01
90	ODBC090	80	16	96,85
110/125	ODBC110	100	16	132,32
140	ODBC140	125	16	162,48
160/180	ODBC160	150	16	205,04
200/225	ODBC200	200	10	227,73
250/280	ODBC250	250	10	297,59
315	ODBC315	300	10	434,45
355	ODBC355	350	10	849,84
400	ODBC400	400	10	970,80

Brida ciega PP con alma de acero DIN 2501.

**OABC**

T1

d	Ref.	DN	€
½"	OABC012	15	68,30
¾"	OABC034	20	69,27
1"	OABC100	25	70,95
1¼"	OABC114	32	76,04
1½"	OABC112	40	86,35
2"	OABC200	50	93,95
2½"	OABC212	65	107,36
3"	OABC300	80	121,04
4"	OABC400	100	165,39
6"	OABC600	150	256,41
8"	OABC800	200	284,74
10"	OABC810	250	371,82
12"	OABC812	300	543,40

Brida ciega PP con alma de acero
ANSI 150 lbs.



RBM

d x dr	Ref. PN6	€ PN6 SDR 17,6	Ref. PN10	€ PN10 SDR 11
25 x 20			RBM11025020	4,36
32 x 20			RBM11032020	5,05
32 x 25			RBM11032025	5,05
40 x 20			RBM11040020	5,79
40 x 25			RBM11040025	5,79
40 x 32			RBM11040032	5,79
50 x 25			RBM11050025	6,07
50 x 32	RBM17050032	5,79	RBM11050032	6,07
50 x 40	RBM17050040	5,79	RBM11050040	6,07
63 x 32	RBM17063032	6,97	RBM11063032	7,37
63 x 40	RBM17063040	6,97	RBM11063040	7,37
63 x 50	RBM17063050	6,97	RBM11063050	7,37
75 x 32	RBM17075032	9,01	RBM11075032	9,44
75 x 40	RBM17075040	9,01	RBM11075040	9,44
75 x 50	RBM17075050	9,01	RBM11075050	9,44
75 x 63	RBM17075063	9,01	RBM11075063	9,44
90 x 50	RBM17090050	10,02	RBM11090050	10,47
90 x 63	RBM17090063	10,02	RBM11090063	10,47
90 x 75	RBM17090075	10,02	RBM11090075	10,47
110 x 50	RBM17110050	12,78	RBM11110050	13,37
110 x 63	RBM17110063	12,78	RBM11110063	13,37
110 x 75	RBM17110075	12,78	RBM11110075	13,37
110 x 90	RBM17110090	12,78	RBM11110090	13,37
125 x 63	RBM17125063	16,39	RBM11125063	17,17
125 x 75	RBM17125075	16,39	RBM11125075	17,17
125 x 90	RBM17125090	16,39	RBM11125090	17,17
125 x 110	RBM17125110	16,39	RBM11125110	17,17
140 x 75	RBM17140075	19,87	RBM11140075	20,82
140 x 90	RBM17140090	19,87	RBM11140090	20,82
140 x 110	RBM17140110	19,87	RBM11140110	20,82
140 x 125	RBM17140125	19,87	RBM11140125	20,82
160 x 90	RBM17160090	23,20	RBM11160090	24,42
160 x 110	RBM17160110	23,20	RBM11160110	24,42
160 x 125	RBM17160125	23,20	RBM11160125	24,42
160 x 140	RBM17160140	23,20	RBM11160140	24,42
180 x 90	RBM17180090	36,44	RBM11180090	38,31
180 x 110	RBM17180110	34,32	RBM11180110	36,04
180 x 125	RBM17180125	31,69	RBM11180125	33,25
180 x 140	RBM17180140	30,05	RBM11180140	31,57
180 x 160	RBM17180160	28,66	RBM11180160	30,12
200 x 140	RBM17200140	82,19	RBM11200140	86,24
200 x 160	RBM17200160	72,68	RBM11200160	76,27
200 x 180	RBM17200180	65,01	RBM11200180	68,30

d x dr	Ref. PN6	€ PN6 SDR 17,6	Ref. PN10	T1 € PN10 SDR 11
225 x 140	RBM17225140	98,11	RBM11225140	103,04
225 x 160	RBM17225160	84,19	RBM11225160	88,40
225 x 180	RBM17225180	80,21	RBM11225180	84,16
225 x 200	RBM17225200	70,63	RBM11225200	74,17
250 x 160	RBM17250160	112,47	RBM11250160	118,05
250 x 180	RBM17250180	104,01	RBM11250180	109,21
250 x 200	RBM17250200	95,74	RBM11250200	100,50
250 x 225	RBM17250225	90,77	RBM11250225	95,22
280 x 200	RBM17280200	125,19	RBM11280200	131,52
280 x 225	RBM17280225	116,75	RBM11280225	122,61
280 x 250	RBM17280250	113,67	RBM11280250	118,05
315 x 200	RBM17315200	159,82	RBM11315200	167,81
315 x 225	RBM17315225	141,37	RBM11315225	148,49
315 x 250	RBM17315250	128,83	RBM11315250	135,23
315 x 280	RBM17315280	120,65	RBM11315280	126,72
355 x 200	RBM17355200	301,56	RBM11355200	316,59
355 x 225	RBM17355225	289,92	RBM11355225	304,38
355 x 250	RBM17355250	278,12	RBM11355250	291,98
355 x 280	RBM17355280	258,01	RBM11355280	270,93
355 x 315	RBM17355315	250,20	RBM11355315	262,70
400 x 225	RBM17400225	1.270,05	RBM11400225	1.353,00
400 x 250	RBM17400250	1.103,30	RBM11400250	1.241,02
400 x 280	RBM17400280	978,50	RBM11400280	978,75
400 x 315	RBM17400315	758,05	RBM11400315	758,05
400 x 355	RBM17400355	512,78	RBM11400355	518,27
450 x 280	RBM17450280	1.379,38	RBM11450280	1.379,38
450 x 315	RBM17450315	1.229,23	RBM11450315	1.229,23
450 x 355	RBM17450355	930,91	RBM11450355	930,91
450 x 400	RBM17450400	687,67	RBM11450400	687,67
500 x 280	RBM17500280	2.178,82	RBM11500280	2.241,13
500 x 315	RBM17500315	1.624,17	RBM11500315	1.669,38
500 x 355	RBM17500355	1.433,73	RBM11500355	1.537,43
500 x 400	RBM17500400	1.235,61	RBM11500400	1.348,74
500 x 450	RBM17500450	1.122,44	RBM11500450	1.216,81
560 x 355	RBM17560355	2.376,12	RBM11560355	2.504,62
560 x 400	RBM17560400	1.990,14	RBM11560400	2.301,48
560 x 450	RBM17560450	1.311,04	RBM11560450	1.367,70
560 x 500	RBM17560500	1.037,48	RBM11560500	1.112,93
630 x 355	RBM17630355	3.197,48		
630 x 400	RBM17630400	2.735,29		
630 x 450	RBM17630450	2.282,61		
630 x 500	RBM17630500	2.188,24		
630 x 560	RBM17630560	1.405,43		
710 x 500	RBM17710500	1.689,13		
710 x 560	RBM17710560	1.412,80		
710 x 630	RBM17710630	1.167,63		
800 x 560	RBM17800560	2.094,79		
800 x 630	RBM17800630	1.766,79		
800 x 710	RBM17800710	1.487,22		

Reducción concéntrica.

M-M para soldar a testa.

**DBMM**

T1

€ PN10
SDR 11

d x Rh	Ref.	€
20 x 1/2"	DBMM11020012	8,72
25 x 3/4"	DBMM11025034	11,24
32 x 1"	DBMM11032100	13,25
40 x 1 1/4"	DBMM11040114	15,51
50 x 1 1/2"	DBMM11050112	19,44
63 x 2"	DBMM11063200	23,00

Terminal rosca hembra largo.

M para soldar a testa o electrofusión - H roscar.

**KBFM**

T1

€ PN10
SDR 11

d x Rh	Ref.	€
20 x 1/2"	KBFM11020012	8,76
25 x 3/4"	KBFM11025034	10,50
32 x 1"	KBFM11032100	13,25
40 x 1 1/4"	KBFM11040114	15,95
50 x 1 1/2"	KBFM11050112	26,15
63 x 2"	KBFM11063200	33,00

Terminal rosca macho corto.

M para soldar a testa - M roscar.

**BBM/L**

T1

€
FKM

d	Ref. EPDM	€ EPDM	Ref. FKM	€ FKM
20	BBML11020E	16,77	BBML11020F	18,76
25	BBML11025E	20,91	BBML11025F	23,51
32	BBML11032E	21,52	BBML11032F	23,78
40	BBML11040E	30,52	BBML11040F	36,01
50	BBML11050E	38,15	BBML11050F	44,10
63	BBML11063E	50,07	BBML11063F	56,91

Unión 3 piezas largo.

SDR 11 (PN10).

M-M para soldar a testa y electrofusión.

**BBM/C**

T1

€
FKM

d	Ref. EPDM	€ EPDM	Ref. FKM	€ FKM
20	BBMC11020E	16,77	BBMC11020F	18,76
25	BBMC11025E	20,91	BBMC11025F	23,51
32	BBMC11032E	21,52	BBMC11032F	23,78
40	BBMC11040E	30,52	BBMC11040F	36,01
50	BBMC11050E	38,15	BBMC11050F	44,10
63	BBMC11063E	50,07	BBMC11063F	56,91

Unión 3 piezas corto.

SDR 11 (PN10).

M-M para soldar a testa.

**Q-BBM/L**

T1

€
SDR 11

d	Ref.	€
20	QBBML11020	4,43
25	QBBML11025	5,35
32	QBBML11032	6,57
40	QBBML11040	8,53
50	QBBML11050	9,01
63	QBBML11063	12,96
75	QBBML11075	18,40
90	QBBML11090	20,54
110	QBBML11110	26,73

Manguito porta tuerca unión 3 piezas largo.

M para soldar a testa y electrofusión.

**Q-BBM/C**

T1

€
SDR 11

d	Ref.	€
20	QBBMC11020	4,43
25	QBBMC11025	5,62
32	QBBMC11032	5,62
40	QBBMC11040	9,47
50	QBBMC11050	9,47
63	QBBMC11063	10,39
75	QBBMC11075	14,20
90	QBBMC11090	19,39
110	QBBMC11110	25,20

Manguito porta tuerca unión 3 piezas corto.

M para soldar a testa.

**F-BBM/L**

d	Ref.	T1 € SDR 11
20	FBBML11020	7,73
25	FBBML11025	9,67
32	FBBML11032	9,67
40	FBBML11040	14,39
50	FBBML11050	14,39
63	FBBML11063	17,04
75	FBBML11075	21,78
90	FBBML11090	27,90
110	FBBML11110	31,88

Manguito para tuerca unión 3 piezas largo.

SDR 11 (PN10).

M para soldar a testa y electrofusión.

**F-BBM/C**

d	Ref.	T1 € SDR 11
20	FBBMC11020	6,71
25	FBBMC11025	8,40
32	FBBMC11032	8,40
40	FBBMC11040	12,50
50	FBBMC11050	12,50
63	FBBMC11063	14,81
75	FBBMC11075	20,20
90	FBBMC11090	26,37
110	FBBMC11110	32,21

Manguito para tuerca unión 3 piezas corto.

SDR 11 (PN10).

M para soldar a testa.

**N-BBM**

d	Ref.	Rh	€
20	EFGM100	1"	5,79
25	EFGM114	1¼"	6,00
32	EFGM112	1½"	6,96
40	EFGM200	2"	8,89
50	EFGM214	2¼"	13,77
63	EFGM234	2¾"	22,20

Tuerca para unión 3 piezas BBM
largo y corto.

H roscar.

**O-BBM**

d	Ref. EPDM	€ EPDM	Ref. FKM	€ FKM
20	OR4081E	4,01	OR4081F	10,61
25	OR4112E	1,44	OR4112F	2,00
32	OR4131E	2,05	OR4131F	5,65
40	OR6162E	2,18	OR6162F	8,33
50	OR6187E	2,32	OR6187F	9,50
63	OR6237E	2,53	OR6237F	10,61

Junta tórica para unión 3 piezas BBM
largo y corto.

Tubo y accesorios
Válvulas manuales
Válvulas actuadas
Válvulas de control de presión

Sistema
PVDF

INDUSTRIA





Sistema PVDF



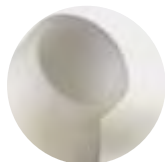

Y

d	Ref.	Epesor mm.	€/m.
16	PIPEF21016	1,9	21,04
20	PIPEF21020	1,9	31,54
25	PIPEF21025	1,9	40,61
32	PIPEF21032	2,4	66,20
40	PIPEF21040	2,4	82,92
50	PIPEF21050	3,0	128,22
63	PIPEF21063	3,0	164,17
75	PIPEF21075	3,6	233,60
90	PIPEF21090	4,3	334,41
110	PIPEF21110	5,3	500,09

Tubo PVDF ISO 10931-2.
PN16. Barras de 5 m.

Disponible en Pn10
de 63 a 110 mm.
Precios consultar



GIF

Y

d	Ref.	Pack	€
16	GIF016	10	5,57
20	GIF020	10	6,38
25	GIF025	10	7,89
32	GIF032	10	16,42
40	GIF040	5	26,35
50	GIF050	5	39,12
63	GIF063	2	66,31
75	GIF075	2	113,78
90	GIF090	2	168,62
110	GIF110	2	309,97

Codo 90°.

H-H para fusión socket.



HIF

Y

d	Ref.	Pack	€
20	HIF020	10	7,53
25	HIF025	10	10,97
32	HIF032	10	12,85
40	HIF040	5	21,58
50	HIF050	5	23,94
63	HIF063	5	38,64
75	HIF075	2	95,95
90	HIF090	2	145,83
110	HIF110	2	259,79

Codo 45°.

H-H para fusión socket.



TIF

Y

d	Ref.	Pack	€
16	TIF016	10	10,59
20	TIF020	10	11,16
25	TIF025	10	13,71
32	TIF032	10	20,35
40	TIF040	5	31,65
50	TIF050	5	48,29
63	TIF063	5	75,88
75	TIF075	2	143,58
90	TIF090	2	216,56
110	TIF110	2	397,44

Te a 90°.

H-H-H para fusión socket.



CIF

Y

d	Ref.	Pack	€
16*	CIF016	10	7,01
20	CIF020	10	7,89
25	CIF025	10	8,64
32	CIF032	10	9,94
40	CIF040	5	18,95
50	CIF050	5	22,31
63	CIF063	5	36,01
75	CIF075	2	37,80
90	CIF090	2	46,81
110	CIF110	2	68,75

Tapón.

H para fusión socket.



QRNF

Y

d	Ref.	Pack	€
20	QRNF020	10	7,23
25	QRNF025	10	9,09
32	QRNF032	10	9,26
40	QRNF040	5	15,40
50	QRNF050	5	18,21
63	QRNF063	2	27,78
75	QRNF075	2	53,40
90	QRNF090	2	72,89
110	QRNF110	2	94,75

Manguito portabridas.

H para fusión socket.



QRAF

Y

d	Ref.	Pack	€
¾"	QRAF034	10	10,92
1"	QRAF100	10	9,26
1¼"	QRAF114	5	18,47
1½"	QRAF112	5	21,85
3"	QRAF300	-	113,68

Manguito portabridas **ANSI 150 lbs.**

H para fusión socket.



MIF

Y

d	Ref.	Pack	€
20	MIF020	10	4,59
25	MIF025	10	5,45
32	MIF032	10	7,39
40	MIF040	5	11,16
50	MIF050	5	32,92
63	MIF063	2	47,35
75	MIF075	2	49,82
90	MIF090	2	77,03
110	MIF110	2	142,45

Manguito.

H-H para fusión socket.



RIF

Y

dm x dh	Ref.	Pack	€
20 x 16	RIF020016	10	6,62
25 x 20	RIF025020	10	7,78
32 x 25	RIF032025	10	10,45
40 x 25	RIF040025	10	12,77
40 x 32	RIF040032	10	14,44
50 x 32	RIF050032	5	15,54
50 x 40	RIF050040	5	18,20
63 x 32	RIF063032	5	21,84
63 x 50	RIF063050	5	23,18
75 x 63	RIF075063	2	48,29
90 x 63	RIF090063	2	52,63
90 x 75	RIF090075	2	52,63
110 x 90	RIF110090	2	79,44

Reducción cónica

M-H para fusión socket.



ODC

B1

d	Ref.	DN	€
20	ODC020	15	4,27
25	ODC025	20	5,08
32	ODC032	25	5,88
40	ODC040	32	7,20
50	ODC050	40	9,30
63	ODC063	50	10,35
75	ODC075	65	15,42
90	ODC090	80	17,03
110	ODC110	100	23,39

Brida loca.

UNI 2223 PN10. En C-PVC para manguito portabridas.



ODB

T1

d	Ref.	DN	€
20	ODB020	15	7,15
25	ODB025	20	7,86
32	ODB032	25	10,13
40	ODB040	32	12,28
50	ODB050	40	14,36
63	ODB063	50	17,85
75	ODB075	65	19,73
90	ODB090	80	23,50
125	**ODB125	100	28,36

Brida loca.

En PP con alma de acero.

PN10. Para manguito portabridas.

Versión ANSI 150 lbs (ver OAB página 370)

Más diámetros en página 370

**Para uso con portabridas QRNF110.



BIGF

Y

d	Ref.	Pack	€ FKM
20	BIGF020F	10	20,27
25	BIGF025F	10	27,33
32	BIGF032F	10	33,19
40	BIGF040F	2	47,35
50	BIGF050F	2	65,93
63	BIGF063F	2	99,61

Unión 3 piezas.

Junta FKM.

H-H para fusión socket.



INDUSTRIA

Sistema PVDF Válvulas de bola



BIFXF

d x Rh	Ref.	Y € FKM
20 x 1/2"	BIFXF020012F	91,82
25 x 3/4"	BIFXF025034F	135,92
32 x 1"	BIFXF032100F	167,54
40 x 1 1/4"	BIFXF040114F	228,42
50 x 1 1/2"	BIFXF050112F	244,11
63 x 2"	BIFXF063200F	284,01

Unión 3 piezas mixto PVDF / Inox A316L.

Junta FKM.

H-H para fusión socket - roscar inox



BIRXF

d x Rm	Ref.	Y € FKM
20 x 1/2"	BIRXF020012F	103,36
25 x 3/4"	BIRXF025034F	151,53
32 x 1"	BIRXF032100F	192,21
40 x 1 1/4"	BIRXF040114F	280,25
50 x 1 1/2"	BIRXF050112F	285,68
63 x 2"	BIRXF063200F	329,94

Unión 3 piezas mixto PVDF / Inox A316L.

Junta FKM.

H-M para fusión socket - roscar inox



VKDIF

d	Ref.	DN	PN	Z € FKM
16	VKDIF016F	10	16	105,46
20	VKDIF020F	15	16	109,56
25	VKDIF025F	20	16	136,51
32	VKDIF032F	25	16	175,18
40	VKDIF040F	32	16	226,84
50	VKDIF050F	40	16	326,85
63	VKDIF063F	50	16	485,91

Válvula de bola DUAL BLOCK®.

Asiento PTFE (teflón). Bidireccional.

H-H para fusión socket.

Disponemos de manguitos
roscados para estas válvulas



VKDDF

d	Ref. EPDM	DN	PN	Z € FKM
20	VKDDF020F	15	16	129,01
25	VKDDF025F	20	16	161,31
32	VKDDF032F	25	16	204,27
40	VKDDF040F	32	16	258,00
50	VKDDF050F	40	16	376,28
63	VKDDF063F	50	16	559,00

Válvula de bola DUAL BLOCK®.

Asiento PTFE (teflón). Bidireccional.

M-M para fusión socket.



VKDIF

d	Ref.	DN	PN	Z € FKM
75	VKDIF075F	65	16	1.261,63
90	VKDIF090F	80	16	1.589,03
110	VKDIF110F	100	16	2.315,98

Válvula de bola DUAL BLOCK®.

Asiento PTFE (teflón). Bidireccional.

H-H para fusión socket.



VKDDF

d	Ref.	DN	PN	Z € FKM
75	VKDDF075F	65	16	1.387,77
90	VKDDF090F	80	16	1.747,90
110	VKDDF110F	100	16	2.547,63

Válvula de bola DUAL BLOCK®.

Asiento PTFE (teflón). Bidireccional.

M-M para fusión socket.



VKDBF

d	Ref.	DN	PN	Z € FKM
20	VKDBF020F	15	16	129,01
25	VKDBF025F	20	16	161,31
32	VKDBF032F	25	16	204,27
40	VKDBF040F	32	16	258,00
50	VKDBF050F	40	16	376,28
63	VKDBF063F	50	16	559,00

Válvula de bola DUAL BLOCK®.
Asiento PTFE (teflón). Bidireccional.
M-M para fusión a tope.



VKDOF

d	Ref.	DN	PN	Z € FKM
20	VKDOF020F	15	16	241,42
25	VKDOF025F	20	16	292,43
32	VKDOF032F	25	16	377,65
40	VKDOF040F	32	16	463,36
50	VKDOF050F	40	16	667,39
63	VKDOF063F	50	16	901,30

Válvula de bola DUAL BLOCK®. [Versión con bridas ANSI 150 lbs al mismo precio](#)
Asiento PTFE (teflón). Bidireccional.
Con brida loca.



VKDBF

d	Ref.	DN	PN	Z € FKM
75	VKDBF075F	65	16	1.387,79
90	VKDBF090F	80	16	1.747,90
110	VKDBF110F	100	16	2.547,60

Válvula de bola DUAL BLOCK®.
Asiento PTFE (teflón). Bidireccional.
M-M para fusión a tope.



VKDOF

d	Ref.	DN	PN	Z € FKM
75	VKDOF075F	65	16	1.640,13
90	VKDOF090F	80	16	2.065,71
110	VKDOF110F	100	16	3.010,80

Válvula de bola DUAL BLOCK®.
Asiento PTFE (teflón). Bidireccional.
Con brida loca DIN y ANSI.



SETFLOF

d DIN	d ANSI	Ref. DIN	€ DIN 2501	Z € ANSI
20	1/2"	SETFLOF020	81,27	81,26
25	3/4"	SETFLOF025	102,24	102,24
32	1"	SETFLOF032	125,37	125,37
40	1 1/4"	SETFLOF040	169,97	169,97
50	1 1/2"	SETFLOF050	206,87	206,87

Set embridado.

Compuesto por 1 brida, 1 anillo fijación y 1 tuerca.
Para Válvulas VKD / VKR / SR.

d DIN	d ANSI	Ref. DIN	€ DIN 2501	Z € ANSI
63	2"	SETFLOF063	270,56	270,56
75	2 1/2"	SETFLOF075		416,04
90	3"	SETFLOF090		623,45
110	4"	SETFLOF110		803,44

d. 75-90-110, es el mismo artículo para DIN y ANSI



VKRIF

d	Ref.	DN	PN	Z € FKM
16	VKRIF016F	10	16	216,69
20	VKRIF020F	15	16	220,80
25	VKRIF025F	20	16	251,56
32	VKRIF032F	25	16	304,68
40	VKRIF040F	32	16	371,62
50	VKRIF050F	40	16	617,82
63	VKRIF063F	50	16	1.040,2

Válvula de bola **REGULACIÓN DUAL BLOCK®**.

Asiento PTFE (teflón). Bidireccional
H-H para fusión socket.



VKRDF

d	Ref.	DN	PN	Z € FKM
20	VKRDF020F	15	16	240,25
25	VKRDF025F	20	16	276,35
32	VKRDF032F	25	16	333,77
40	VKRDF040F	32	16	402,79
50	VKRDF050F	40	16	667,28
63	VKRDF063F	50	16	1.113,29

Válvula de bola **REGULACIÓN DUAL BLOCK®**.

Asiento PTFE (teflón). Bidireccional
M-M para fusión socket.



VKRBF

d	Ref.	DN	PN	Z € FKM
20	VKRBF020F	15	16	240,25
25	VKRBF025F	20	16	276,35
32	VKRBF032F	25	16	333,77
40	VKRBF040F	32	16	402,79
50	VKRBF050F	40	16	667,28
63	VKRBF063F	50	16	1.113,29

Válvula de bola **REGULACIÓN DUAL BLOCK®**.

Asiento PTFE (teflón). Bidireccional
M-M para fusión a tope.



VKROF

d	Ref.	DN	PN	Z € FKM
20	VKROF020F	15	16	352,66
25	VKROF025F	20	16	407,46
32	VKROF032F	25	16	507,15
40	VKROF040F	32	16	608,13
50	VKROF050F	40	16	958,38
63	VKROF063F	50	16	1.455,59

Válvula de bola **REGULACIÓN DUAL BLOCK®**.

Asiento PTFE (teflón). Bidireccional
Con brida DIN 2501.



VKROAF

d	Ref.	DN	PN	Z € FKM
½"	VKROAF012F	15	16	352,66
¾"	VKROAF034F	20	16	407,46
1"	VKROAF100F	25	16	507,15
1¼"	VKROAF114F	32	16	608,13
1½"	VKROAF112F	40	16	958,38
2"	VKROAF200F	50	16	1.455,59

Válvula de bola **REGULACIÓN DUAL BLOCK®**.

Asiento PTFE (teflón). Bidireccional
Con bridas ANSI 150 lbs.



INDUSTRIA

Sistema PVDF Válvulas de mariposa



FKOF/FM

d	Ref.	DN	G € FKM
50	FKOFFM050F	40	338,16
63	FKOFFM063F	50	358,05
75	FKOFFM075F	65	397,83
90	FKOFFM090F	80	426,84
110	FKOFFM110F	100	446,03
125	FKOFFM140F	125	592,35
140	FKOFFM140F	125	592,35
160	FKOFFM160F	150	633,58
200	FKOFFM225F	200	821,97
225	FKOFFM225F	200	821,97
250**	FKOFFM280F	250	3.050,72
280**	FKOFFM280F	250	3.050,72
315**	FKOFFM315F	300	3.326,79
355**	FKOFFM355F	355	6.870,04
400**	FKOFFM400F	400	8.420,77

Válvula de mariposa industrial.
A EJE LIBRE.

Para actuar. Cuerpo en PPGR,
eje inoxidable y disco en PVDF

** ANSI 150 lbs bajo pedido
al mismo precio.



FKOF/FM

d	Ref.	DN	G € FKM
75	FKOLFFM075F	65	506,47
90	FKOLFFM090F	80	568,79
110	FKOLFFM110F	100	600,25
125	FKOLFFM140F	125	798,27
140	FKOLFFM140F	125	798,27
160	FKOLFFM160F	150	856,12
200	FKOLFFM225F	200	1.052,40
225	FKOLFFM225F	200	1.052,40

Válvula de mariposa industrial.
A EJE LIBRE. LUG ISO-DIN.

Cuerpo en PPGR,
eje inoxidable y disco en PVDF



FKOF/LM

d	Ref.	DN	G € FKM
50	FKOFLM050F	40	378,38
63	FKOFLM063F	50	400,65
75	FKOFLM075F	65	445,12
90	FKOFLM090F	80	463,56
110	FKOFLM110F	100	492,47
125	FKOFLM140F	125	654,58
140	FKOFLM140F	125	654,58
160	FKOFLM160F	150	672,99
200	FKOFLM225F	200	872,75
225	FKOFLM225F	200	872,75

Válvula de mariposa industrial.

CON MANETA.

Cuerpo en PPGR,
eje inoxidable y disco en PVDF



FKOF/RM

d	Ref.	DN	G € FKM
75	FKOFRM075F	65	797,41
90	FKOFRM090F	80	815,83
110	FKOFRM110F	100	845,59
125	FKOFRM140F	125	1.006,84
140	FKOFRM140F	125	1.006,84
160	FKOFRM160F	150	1.025,25
200	FKOFRM225F	200	1.305,66
225	FKOFRM225F	200	1.305,66
250**	FKOFRM280F	250	3.301,37
280**	FKOFRM280F	250	3.301,37
315**	FKOFRM315F	300	3.577,44
355**	FKOFRM350F	350	7.471,11
400**	FKOFRM400F	400	9.021,82

Válvula de mariposa industrial.

CON VOLANTE.

Cuerpo en PPGR,
eje inoxidable y disco en PVDF

** ANSI 150 lbs bajo pedido
al mismo precio.



FKOF/LM

d	Ref.	DN	G € FKM
75	FKOLFLM075F	65	553,81
90	FKOLFLM090F	80	605,51
110	FKOLFLM110F	100	646,66
125	FKOLFLM140F	125	860,47
140	FKOLFLM140F	125	860,47
160	FKOLFLM160F	150	895,58
200	FKOLFLM225F	200	1.103,21
225	FKOLFLM225F	200	1.103,21

Válvula de mariposa industrial. **CON MANETA. LUG ISO-DIN.**
 Cuerpo en PPGR, eje inoxidable y disco en PVDF



FKOF/RM

d	Ref.	DN	G € FKM
75	FKOLFRM075F	65	906,09
90	FKOLFRM090F	80	957,74
110	FKOLFRM110F	100	999,81
125	FKOLFRM140F	125	1.212,75
140	FKOLFRM140F	125	1.212,75
160	FKOLFRM160F	150	1.247,79
200	FKOLFRM225F	200	1.536,07
225	FKOLFRM225F	200	1.536,07

Válvula de mariposa industrial. **CON VOLANTE. LUG ISO-DIN.**
 Cuerpo en PPGR, eje inoxidable y disco en PVDF



FKOF/FM

d	Ref.	DN	G € FKM
2½"	FKOALFFM212F	65	560,79
3"	FKOALFFM300F	80	625,67
4"	FKOALFFM400F	100	662,44
5"	FKOALFFM500F	125	880,63
6"	FKOALFFM600F	150	945,49
8"	FKOALFFM800F	200	1.165,54
10"	FKOALFFM810F	250	4.155,51
12"	FKOALFFM812F	300	4.456,90

Válvula de mariposa industrial. **A EJE LIBRE. LUG ANSI.**
 Para actuar. Cuerpo en PPGR, eje inoxidable y disco en PVDF



FKOF/LM

d	Ref.	DN	G € FKM
2½"	FKOALFLM212F	65	608,14
3"	FKOALFLM300F	80	662,44
4"	FKOALFLM400F	100	708,92
5"	FKOALFLM500F	125	942,84
6"	FKOALFLM600F	150	984,93
8"	FKOALFLM800F	200	1.217,96

Válvula de mariposa industrial. **CON MANETA. LUG ANSI.**
 Cuerpo en PPGR, eje inoxidable y disco en PVDF



FKOF/RM

d	Ref.	DN	G € FKM
2½"	FKOALFRM212F	65	960,40
3"	FKOALFRM300F	80	1.014,71
4"	FKOALFRM400F	100	1.062,03
5"	FKOALFRM500F	125	1.295,11
6"	FKOALFRM600F	150	1.337,17
8"	FKOALFRM800F	200	1.650,87
10"	FKOALFRM810F	250	4.406,14
12"	FKOALFRM812F	300	4.707,57

Válvula de mariposa industrial. **CON VOLANTE. LUG ANSI.**
 Cuerpo en PPGR, eje inoxidable y disco en PVDF



DKDF

d	Ref. EPDM	DN	PN	€ EPDM	€ FKM	A1 € PTFE
20	DKDF020E	15	10	116,26	159,04	177,60
25	DKDF025E	20	10	120,68	165,63	183,12
32	DKDF032E	25	10	139,27	183,12	199,56
40	DKDF040E	32	10	226,99	299,37	320,23
50	DKDF050E	40	10	260,99	334,47	355,35
63	DKDF063E	50	10	330,07	451,81	448,49
75	DKDF075E	65	10	396,08	542,18	538,19

Válvula de membrana
DIALOCK®.

M-M para soldar socket.

Código en FKM termina en "F"
en lugar de "E"
Código en PTFE termina en "P"
en lugar de "E"



DKOF

d	Ref. EPDM	DN	PN	€ EPDM	€ FKM	A1 € PTFE
20	DKOF020E	15	10	210,23	252,98	271,58
25	DKOF025E	20	10	218,72	263,65	281,15
32	DKOF032E	25	10	241,91	285,76	302,20
40	DKOF040E	32	10	379,99	452,35	473,22
50	DKOF050E	40	10	420,23	493,70	514,54
63	DKOF063E	50	10	547,52	669,26	665,92
75*	DKOF075E	65	10	711,76	870,05	865,69

Válvula de membrana
DIALOCK®.

Con bridas DIN.

Código en FKM termina en "F"
en lugar de "E"
Código en PTFE termina en "P"
en lugar de "E"



VMDF

d	Ref. EPDM	DN	€ EPDM	€ FKM	A1 € PTFE
90	VMDF090E	80	1.178,84	1.527,58	1.342,32
110	VMDF110E	100	1.499,06	2.081,41	1.700,88

Válvula de membrana.
M-M para fusión socket.

Código en FKM termina en "F"
en lugar de "E"
Código en PTFE termina en "P"
en lugar de "E"



VMOF

d	Ref. EPDM	DN	€ EPDM	€ FKM	A1 € PTFE
90	VMOF090E	80	1.510,26	1.858,98	1.673,73
110	VMOF110E	100	1.891,88	2.474,23	2.093,71

Válvula de membrana.
Con bridas DIN. Bajo pedido
con bridas ANSI 150 lbs,
la mismo precio.

Código en FKM termina en "F"
en lugar de "E"
Código en PTFE termina en "P"
en lugar de "E"



DKLDF

d	Ref. EPDM	DN	PN	€ EPDM	€ FKM	A1 € PTFE
20	DKLDF020E	15	10	203,93	246,70	265,26
25	DKLDF025E	20	10	208,34	253,27	270,79
32	DKLDF032E	25	10	226,92	270,79	287,22
40	DKLDF040E	32	10	314,66	387,03	407,88
50	DKLDF050E	40	10	373,71	447,18	468,05
63	DKLDF063E	50	10	442,78	564,52	561,19
75	DKLDF075E	65	10	531,34	677,42	673,44

Válvula de membrana
DIALOCK®. **CON LIMITADOR
DE CARRERA.**

M-M para soldar socket.

Código en FKM termina en "F"
en lugar de "E"
Código en PTFE termina en "P"
en lugar de "E"



DKOAF

d	Ref. EPDM	DN	PN	€ EPDM	€ FKM	A1 € PTFE
½"	DKOAF012E	15	10	210,23	252,98	271,58
¾"	DKOAF034E	20	10	218,72	263,65	281,15
1"	DKOAF100E	25	10	241,91	285,76	302,20
1¼"	DKOAF114E	32	10	379,99	452,35	473,22
1½"	DKOAF112E	40	10	420,23	493,70	514,54
2"	DKOAF200E	50	10	547,52	669,26	665,92
2 ½"	DKOAF212E	65	10	711,76	870,05	865,69

Válvula de membrana
DIALOCK®.

Con bridas ANSI 150 lbs.

Código en FKM termina en "F"
en lugar de "E"
Código en PTFE termina en "P"
en lugar de "E"



DKUIF

d	Ref. EPDM	DN	PN	A1		
				€ EPDM	€ FKM	€ PTFE
20	DKUIF020E	15	10	156,87	199,56	218,25
25	DKUIF025E	20	10	165,63	210,57	228,10
32	DKUIF032E	25	10	197,40	241,26	257,68
40	DKUIF040E	32	10	314,71	387,09	407,93
50	DKUIF050E	40	10	365,18	437,60	458,42
63	DKUIF063E	50	10	472,65	594,33	591,10

Válvula de membrana DIALOCK®.
Con enlaces H-H para soldar socket.

Código en FKM termina en "F" en lugar de "E"
Código en PTFE termina en "P" en lugar de "E"



DKLUIF

d	Ref. EPDM	DN	PN	A1		
				€ EPDM	€ FKM	€ PTFE
20	DKLUIF020E	15	10	244,52	287,22	305,91
25	DKLUIF025E	20	10	253,27	298,22	315,76
32	DKLUIF032E	25	10	285,04	328,92	345,34
40	DKLUIF040E	32	10	402,35	474,75	495,58
50	DKLUIF050E	40	10	477,89	550,29	571,13
63	DKLUIF063E	50	10	585,35	707,05	703,80

Válvula de membrana DIALOCK®.
CON LIMITADOR DE CARRERA.
Con enlaces H-H para soldar socket.

Código en FKM termina en "F" en lugar de "E"
Código en PTFE termina en "P" en lugar de "E"

CMDF CMIF
M-M fusión socket. H-H fusión socket.



CMUIF CMFF
H-H enlaces socket. H-H roscar.

d-Rh	Ref. EPDM	DN	A1		
			€ EPDM	€ FKM	€ PTFE
20	CMDF020E	15	106,42	114,29	119,51
16	CMIF016E	12	76,74	82,21	90,99
20	CMIF020E	15	85,57	100,93	110,63
20	CMUIF020E	15	111,93	119,51	125,03
3/8"	CMFF038E	12	76,74	82,21	90,99
1/2"	CMFF012E	15	85,57	100,93	110,63

Válvula de membrana compacta.

Código en FKM termina en "F" en lugar de "E"
Código en PIFE termina en "P" en lugar de "E"

FROF

d	Ref. FKM	DN	PN	Z	
				€ FKM	€ PTFE
40	FROF040FMLX	32	6	599,78	700,74
50	FROF050FMLX	40	6	603,62	710,73
63	FROF063FMLX	50	6	644,43	747,53
75	FROF075FMLX	65	6	660,45	783,06
90	FROF090FMLX	80	6	942,13	1.123,29
110	FROF110FMLX	100	6	1.152,26	1.362,04
140	FROF140FMLX	125	6	1.265,01	1.511,96
160	FROF160FMLX	150	6	2.011,59	2.391,18
225	FROF225FMLX	200	6	3.454,68	4.152,83
280	FROF280FMLX	250	6	5.160,52	6.261,70
315	FROF315FMLX	300	6	7.755,50	9.498,10

Válvula anti-retorno de clapeta con resorte inox. ISO/DIN.

Código en PTFE termina en "PMLX" en lugar de "FMLX"

FROF

d	Ref. FKM	DN	PN	Z	
				€ FKM	€ PTFE
40	FROF040F	32	6	532,21	633,13
50	FROF050F	40	6	536,05	643,16
63	FROF063F	50	6	572,51	675,58
75	FROF075F	65	6	584,61	707,27
90	FROF090F	80	6	862,44	1.043,57
110	FROF110F	100	6	1.064,33	1.274,08
140	FROF140F	125	6	1.177,06	1.424,01
160	FROF160F	150	6	1.898,16	2.277,74
225	FROF225F	200	6	3.325,21	4.023,34
280	FROF280F	250	6	5.005,80	6.106,94
315	FROF315F	300	6	7.576,95	9.319,57

Válvula anti-retorno de clapeta sin resorte. ISO/DIN.

Código en PTFE termina en "P" en lugar de "F"

FROAF

d	Ref. FKM	DN	PN	Z	
				€ FKM	€ PTFE
1 1/4"	FROAF114F	32	6	589,98	714,76
1 1/2"	FROAF112F	40	6	587,00	720,46
2"	FROAF200F	50	6	627,73	764,38
2 1/2"	FROAF212F	65	6	637,23	810,15
3"	FROAF300F	80	6	945,04	1.146,57
4"	FROAF400F	100	6	1.166,32	1.403,81
5"	FROAF500F	125	6	1.282,47	1.548,58
6"	FROAF600F	150	6	2.060,62	2.370,90
8"	FROAF800F	200	6	3.666,24	3.996,90
10"	FROAF810F	250	6	5.441,06	5.888,72
12"	FROAF812F	300	6	8.352,07	8.884,25

Válvula anti-retorno de clapeta sin resorte. ANSI 150 lbs.

Código en PTFE termina en "P" en lugar de "F"



INDUSTRIA

Sistema PVDF

Válvulas de bola actuadas



FROAF

d	Ref. FKM	DN	PN	Z	
				€ FKM	€ PTFE
1 1/4"	FROAF114FMLX	32	6	657,55	782,34
1 1/2"	FROAF112FMLX	40	6	654,60	788,05
2"	FROAF200FMLX	50	6	699,35	836,28
2 1/2"	FROAF212FMLX	65	6	713,05	885,95
3"	FROAF300FMLX	80	6	1.024,75	1.226,28
4"	FROAF400FMLX	100	6	1.254,32	1.491,77
5"	FROAF500FMLX	125	6	1.370,43	1.636,51
6"	FROAF600FMLX	150	6	2.174,03	2.484,32
8"	FROAF800FMLX	200	6	3.795,70	4.126,34
10"	FROAF810FMLX	250	6	5.595,80	6.043,44
12"	FROAF812FMLX	300	6	8.530,65	9.062,82

Válvula anti-retorno de clapeta con resorte inox. **ANSI 150 lbs.**

Código en PTFE termina en "FMLX" en lugar de "FMLX"

SRIF

d	Ref.	DN	PN	Pack	Z	
					€ FKM	€ PTFE
20	SRIF020F	15	16	1	147,99	
25	SRIF025F	20	16	1	182,10	
32	SRIF032F	25	16	1	211,90	
40	SRIF040F	32	16	1	370,52	
50	SRIF050F	40	16	1	399,25	
63	SRIF063F	50	16	1	674,98	

Válvula de bola anti-retorno
Juntas en FKM.
M-H para fusión socket.

VKDIF/CE

Soldar

ACTUACIÓN ELÉCTRICA
24-240 V AC/DC

ACTUACIÓN ELÉCTRICA CON BLOQUEO DE SEGURIDAD
24-240 V AC/DC

d	ACTUACIÓN ELÉCTRICA		ACTUACIÓN ELÉCTRICA CON BLOQUEO DE SEGURIDAD	
	Ref.	€	Ref.	€
16	VKFE016F2D	691,85	VKFE016F2BD	1.186,73
20	VKFE020F2D	698,51	VKFE020F2BD	1.193,38
25	VKFE025F2D	744,72	VKFE025F2BD	1.239,59
32	VKFE032F2D	807,22	VKFE032F2BD	1.302,10
40	VKFE040F2D	897,34	VKFE040F2BD	1.392,21
50	VKFE050F2D	1.059,17	VKFE050F2BD	1.554,03
63	VKFE063F2D	1.319,78	VKFE063F2BD	1.814,65
75	VKFE075F2D	2.752,52	VKFE075F2BD	3.247,38
90	VKFE090F2D	3.282,34	VKFE090F2BD	3.777,22
110	VKFE110F2D	4.795,79	VKFE110F2BD	5.290,67

Válvula de bola motorizada en PVDF 2 vías DUAL BLOCK®. Actuación eléctrica.

Disponemos de otras conexiones bajo pedido: bridas, soldar macho y roscar (GAS y NPT)
Bajo pedido podemos suministrar otros actuadores: VALPES, BELIMO...
Bajo pedido también disponibles en 12V AC/DC

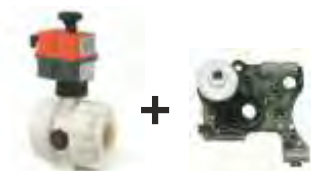

VKRIF/CE

Soldar

K

ACTUACIÓN ELÉCTRICA 24-240 V AC/DC CON POSICIONADOR 4-20 mA

d	Ref.	€
16	VRFE016F2PD	1.285,89
20	VRFE020F2PD	1.292,52
25	VRFE025F2PD	1.344,89
32	VRFE032F2PD	1.430,86
40	VRFE040F2PD	1.545,64
50	VRFE050F2PD	1.944,06
63	VRFE063F2PD	2.630,83

Válvula de bola **REGULACIÓN** motorizada en PVDF 2 vías DUAL BLOCK®.

Actuación eléctrica con posicionador 4-20 mA

Disponemos de otras conexiones bajo pedido: bridas, soldar macho y roscar (GAS y NPT)

Bajo pedido podemos suministrar otros actuadores: VALPES, BELIMO...

Bajo pedido también disponibles en 12V AC/DC

VKDIF/CP

Soldar

K

ACTUACIÓN NEUMÁTICA ALUMINIO

ACTUACIÓN NEUMÁTICA ALUMINIO CON ELECTROVÁLVULA, FINALES DE CARRERA (ELECTROMECAÑICOS) Y REGULADORES DE ESCAPE

d	DOBLE EFECTO		SIMPLE EFECTO		DOBLE EFECTO		SIMPLE EFECTO	
	Ref.	€	Ref.	€	Ref.	€	Ref.	€
16	VKFP016FDED	390,84	VKFP016FSED	418,25	VKFP016FDEFD	569,84	VKFP016FSEFD	606,70
20	VKFP020FDED	397,50	VKFP020FSED	424,90	VKFP020FDEFD	576,50	VKFP020FSEFD	613,35
25	VKFP025FDED	443,73	VKFP025FSED	471,10	VKFP025FDEFD	622,72	VKFP025FSEFD	659,56
32	VKFP032FDED	506,22	VKFP032FSED	533,61	VKFP032FDEFD	685,23	VKFP032FSEFD	722,07
40	VKFP040FDED	596,33	VKFP040FSED	623,72	VKFP040FDEFD	775,33	VKFP040FSEFD	812,18
50	VKFP050FDED	758,16	VKFP050FSED	838,77	VKFP050FDEFD	937,15	VKFP050FSEFD	1.027,23
63	VKFP063FDED	1.018,77	VKFP063FSED	1.169,75	VKFP063FDEFD	1.197,77	VKFP063FSEFD	1.358,21
75	VKFP075FDED	2.307,57	VKFP075FSED	2.414,39	VKFP075FDEFD	2.486,58	VKFP075FSEFD	2.602,86
90	VKFP090FDED	2.837,41	VKFP090FSED	2.944,22	VKFP090FDEFD	3.016,40	VKFP090FSEFD	3.132,69
110	VKFP110FDED	4.038,01	VKFP110FSED	4.416,07	VKFP110FDEFD	4.217,00	VKFP110FSEFD	4.604,54

Válvula de bola motorizada en PVDF 2 vías DUAL BLOCK®. Actuación neumática

Disponemos de otras conexiones bajo pedido: bridas, soldar macho y roscar (NPT)

Las válvulas neumáticas se configuran NC (normalmente cerrada) de serie.

La configuración NA (normalmente abierta) se debe especificar en el pedido



VKRIF/CP

Soldar

**ACTUACIÓN NEUMÁTICA ALUMINIO DOBLE EFECTO
 CON POSICIONADOR 4-20 mA**

**ACTUACIÓN NEUMÁTICA ALUMINIO SIMPLE EFECTO
 CON POSICIONADOR 4-20 mA**

d	Ref.	€	Ref.	€
16	VRFP016FDEPD	2.165,59	VRFP016FSEPD	2.192,98
20	VRFP020FDEPD	2.172,24	VRFP020FSEPD	2.199,65
25	VRFP025FDEPD	2.224,57	VRFP025FSEPD	2.251,98
32	VRFP032FDEPD	2.310,53	VRFP032FSEPD	2.337,94
40	VRFP040FDEPD	2.425,35	VRFP040FSEPD	2.452,74
50	VRFP050FDEPD	2.823,78	VRFP050FSEPD	2.904,39
63	VRFP063FDEPD	3.510,51	VRFP063FSEPD	3.661,51

Válvula de bola **REGULACIÓN** motorizada en PVDF 2 vías DUAL BLOCK®.

Actuación neumática con posicionador 4-20 mA

Disponemos de otras conexiones bajo pedido: bridas, soldar macho y roscar (NPT)
 Las válvulas neumáticas se configuran NC (normalmente cerrada) de serie.
 La configuración NA (normalmente abierta) se debe especificar en el pedido

VKDIF/CP

Soldar

ACTUACIÓN NEUMÁTICA POLIAMIDA

ACTUACIÓN NEUMÁTICA POLIAMIDA CON ELECTROVÁLVULA, FINALES DE CARRERA (ELECTROMECAÑICOS) Y REGULADORES DE ESCAPE

d	DOBLE EFECTO		SIMPLE EFECTO		DOBLE EFECTO		SIMPLE EFECTO	
	Ref.	€	Ref.	€	Ref.	€	Ref.	€
16	VKFP016FDEFP	407,58	VKFP016FSEFP	428,23	VKFP016FDEFP	641,71	VKFP016FSEFP	662,36
20	VKFP020FDEFP	414,22	VKFP020FSEFP	434,87	VKFP020FDEFP	648,36	VKFP020FSEFP	669,01
25	VKFP025FDEFP	460,41	VKFP025FSEFP	481,06	VKFP025FDEFP	694,57	VKFP025FSEFP	715,22
32	VKFP032FDEFP	522,93	VKFP032FSEFP	636,44	VKFP032FDEFP	757,08	VKFP032FSEFP	870,60
40	VKFP040FDEFP	613,05	VKFP040FSEFP	726,57	VKFP040FDEFP	847,20	VKFP040FSEFP	960,72
50	VKFP050FDEFP	774,86	VKFP050FSEFP	996,75	VKFP050FDEFP	1.009,01	VKFP050FSEFP	1.230,89
63	VKFP063FDEFP	1.217,56	VKFP063FSEFP	1.276,89	VKFP063FDEFP	1.451,71	VKFP063FSEFP	1.511,04
75	VKFP075FDEFP	2.422,68	VKFP075FSEFP	2.644,97	VKFP075FDEFP	2.656,84	VKFP075FSEFP	2.879,10
90	VKFP090FDEFP	2.952,51	VKFP090FSEFP	3.174,82	VKFP090FDEFP	3.186,65	VKFP090FSEFP	3.408,96
110	VKFP110FDEFP	4.123,30	VKFP110FSEFP	4.364,57	VKFP110FDEFP	4.357,45	VKFP110FSEFP	4.598,73

Válvula de bola motorizada en PVDF 2 vías DUAL BLOCK®. Actuación neumática

Disponemos de otras conexiones bajo pedido: bridas, soldar macho y roscar (GAS y NPT)
 Las válvulas neumáticas se configuran NC (normalmente cerrada) de serie.
 La configuración NA (normalmente abierta) se debe especificar en el pedido



INDUSTRIA

Sistema PVDF

Válvulas de mariposa actuadas



VKRIF/CP

Soldar

**ACTUACIÓN NEUMÁTICA POLIAMIDA DOBLE EFECTO
CON POSICIONADOR 4-20 mA**

**ACTUACIÓN NEUMÁTICA POLIAMIDA SIMPLE EFECTO
CON POSICIONADOR 4-20 mA**

d	Ref.	€ FKM	Ref.	€ FKM
16	VRFP016FDEPP	1.773,31	VRFP016FSEPP	1.793,96
20	VRFP020FDEPP	1.779,96	VRFP020FSEPP	1.800,61
25	VRFP025FDEPP	1.832,30	VRFP025FSEPP	1.852,93
32	VRFP032FDEPP	1.918,26	VRFP032FSEPP	2.031,77
40	VRFP040FDEPP	2.033,07	VRFP040FSEPP	2.146,58
50	VRFP050FDEPP	2.431,48	VRFP050FSEPP	2.653,38
63	VRFP063FDEPP	3.300,31	VRFP063FSEPP	3.359,64

Válvula de bola **REGULACIÓN** motorizada en PVDF 2 vías DUAL BLOCK®.

Actuación neumática con posicionador 4-20 mA

Disponemos de otras conexiones bajo pedido: bridas, soldar macho y roscar (NPT)

Las válvulas neumáticas se configuran NC (normalmente cerrada) de serie. La configuración NA (normalmente abierta) se debe especificar en el pedido

FKOF/CE

**ACTUACIÓN ELÉCTRICA
24-240 V AC/DC**

**ACTUACIÓN ELÉCTRICA CON BLOQUE DE SEGURIDAD
24-240 V AC/DC**

d	Ref.	€ FKM	Ref.	€ FKM
50	FKFE050F2D	1.009,42	FKFE050F2BD	1.504,30
63	FKFE063F2D	1.039,96	FKFE063F2BD	1.534,85
75	FKFE075F2D	1.332,77	FKFE075F2BD	1.827,62
90	FKFE090F2D	1.377,40	FKFE090F2BD	1.872,23
110	FKFE110F2D	1.406,83	FKFE110F2BD	1.901,69
125	FKFE140F2D	1.958,17	FKFE140F2BD	2.453,07
140	FKFE140F2D	1.958,17	FKFE140F2BD	2.453,07
160	FKFE160F2D	2.237,40	FKFE160F2BD	2.816,50
200	FKFE225F2D	2.655,30	FKFE225F2BD	3.234,41
225	FKFE225F2D	2.655,30	FKFE225F2BD	3.234,41
250	FKFE280F2D	6.147,69	FKFE280F2BD	6.726,78
280	FKFE280F2D	6.147,69	FKFE280F2BD	6.726,78
315	FKFE315F2D	6.572,05	FKFE315F2BD	7.151,17

Válvula de mariposa industrial motorizada cuerpo en PPGR y disco en PVDF.

Actuación eléctrica

Bajo pedido podemos suministrar otros actuadores: VALPES, BELIMO...

Bajo pedido también disponibles en 12V AC/DC



FKOF/CP

K

ACTUACIÓN NEUMÁTICA ALUMINIO

ACTUACIÓN NEUMÁTICA ALUMINIO CON ELECTROVÁLVULA, FINALES DE CARRERA (ELECTROMECAÑICOS) Y REGULADORES DE ESCAPE

d	DOBLE EFECTO		SIMPLE EFECTO		DOBLE EFECTO		SIMPLE EFECTO	
	Ref.	€	Ref.	€	Ref.	€	Ref.	€
50	FKFP050FDED	708,11	FKFP050FSED	788,73	FKFP050FDEFD	887,11	FKFP050FSEFD	977,18
63	FKFP063FDED	738,69	FKFP063FSED	819,29	FKFP063FDEFD	917,67	FKFP063FSEFD	1.007,73
75	FKFP075FDED	831,69	FKFP075FSED	950,81	FKFP075FDEFD	1.010,71	FKFP075FSEFD	1.139,24
90	FKFP090FDED	932,15	FKFP090FSED	1.038,97	FKFP090FDEFD	1.111,15	FKFP090FSEFD	1.227,41
110	FKFP110FDED	961,60	FKFP110FSED	1.363,73	FKFP110FDEFD	1.140,58	FKFP110FSEFD	1.552,19
125	FKFP140FDED	1.215,72	FKFP140FSED	1.820,08	FKFP140FDEFD	1.394,72	FKFP140FSEFD	2.008,52
140	FKFP140FDED	1.215,72	FKFP140FSED	1.820,08	FKFP140FDEFD	1.394,72	FKFP140FSEFD	2.008,52
160	FKFP160FDED	1.279,09	FKFP160FSED	1.883,46	FKFP160FDEFD	1.458,10	FKFP160FSEFD	2.071,90
200	FKFP225FDED	1.820,92	FKFP225FSED	2.650,38	FKFP225FDEFD	1.999,92	FKFP225FSEFD	2.838,86
225	FKFP225FDED	1.820,92	FKFP225FSED	2.650,38	FKFP225FDEFD	1.999,92	FKFP225FSEFD	2.838,86
250	FKFP280FDED	5.474,73	FKFP280FSED	7.233,19	FKFP280FDEFD	5.653,71	FKFP280FSEFD	7.421,66
280	FKFP280FDED	5.474,73	FKFP280FSED	7.233,19	FKFP280FDEFD	5.653,71	FKFP280FSEFD	7.421,66
315	FKFP315FDED	6.138,27	FKFP315FSED	8.566,01	FKFP315FDEFD	6.317,25	FKFP315FSEFD	8.754,48

Válvula de mariposa industrial motorizada cuerpo en PPGR y disco en PVDF.

Actuación neumática

Las válvulas neumáticas se configuran NC (normalmente cerrada) de serie. La configuración NA (normalmente abierta) se debe especificar en el pedido



FKOF/CP

K

ACTUACIÓN NEUMÁTICA POLIAMIDA

ACTUACIÓN NEUMÁTICA POLIAMIDA CON ELECTROVÁLVULA, FINALES DE CARRERA (ELECTROMECAÑICOS) Y REGULADORES DE ESCAPE

d	DOBLE EFECTO		SIMPLE EFECTO		DOBLE EFECTO		SIMPLE EFECTO	
	Ref.	€	Ref.	€	Ref.	€	Ref.	€
50	FKFP050FDEP	803,54	FKFP050FSEP	949,11	FKFP050FDEFP	1.037,67	FKFP050FSEFP	1.183,27
63	FKFP063FDEP	834,11	FKFP063FSEP	979,68	FKFP063FDEFP	1.068,24	FKFP063FSEFP	1.213,83
75	FKFP075FDEP	895,24	FKFP075FSEP	1.040,80	FKFP075FDEFP	1.129,39	FKFP075FSEFP	1.274,95
90	FKFP090FDEP	1.025,76	FKFP090FSEP	1.085,14	FKFP090FDEFP	1.259,92	FKFP090FSEFP	1.319,26
110	FKFP110FDEP	1.055,21	FKFP110FSEP	1.288,74	FKFP110FDEFP	1.289,37	FKFP110FSEFP	1.522,91
125	FKFP140FDEP	1.272,49	FKFP140FSEP	1.773,80	FKFP140FDEFP	1.506,63	FKFP140FSEFP	2.007,95
140	FKFP140FDEP	1.272,49	FKFP140FSEP	1.773,80	FKFP140FDEFP	1.506,63	FKFP140FSEFP	2.007,95
160	FKFP160FDEP	1.499,71	FKFP160FSEP	1.837,17	FKFP160FDEFP	1.733,85	FKFP160FSEFP	2.071,32
200	FKFP225FDEP	1.804,32	FKFP225FSEP	2.500,84	FKFP225FDEFP	2.038,48	FKFP225FSEFP	2.734,98
225	FKFP225FDEP	1.804,32	FKFP225FSEP	2.500,84	FKFP225FDEFP	2.038,48	FKFP225FSEFP	2.734,98
250*	FKFP280FDEP	5.634,14	FKFP280FSEP	7.127,25	FKFP280FDEFP	5.868,29	FKFP280FSEFP	7.361,40
280*	FKFP280FDEP	5.634,14	FKFP280FSEP	7.127,25	FKFP280FDEFP	5.868,29	FKFP280FSEFP	7.361,40
315*	FKFP315FDEP	6.058,53	FKFP315FSEP	7.551,64	FKFP315FDEFP	6.292,66	FKFP315FSEFP	7.785,78

Válvula de mariposa industrial motorizada cuerpo en PPGR y disco en PVDF.

Actuación neumática

Las válvulas neumáticas se configuran NC (normalmente cerrada) de serie. La configuración NA (normalmente abierta) se debe especificar en el pedido

* Actuadores de aluminio



INDUSTRIA

Sistema PVDF

Válvulas de membrana actuadas

**DK/CP NC****VM/CP NC**

d	Modelo	DN	€		€		L	€
			Ref. EPDM	EPDM	Ref. FKM	FKM		
20	DKDF/CP NC	15	DKDFNC020E	258,48	DKDFNC020F	297,18	DKDFNC020P	311,32
25	DKDF/CP NC	20	DKDFNC025E	269,65	DKDFNC025F	308,35	DKDFNC025P	323,24
32	DKDF/CP NC	25	DKDFNC032E	332,10	DKDFNC032F	375,04	DKDFNC032P	392,58
40	DKDF/CP NC	32	DKDFNC040E	495,13	DKDFNC040F	568,73	DKDFNC040P	588,00
50	DKDF/CP NC	40	DKDFNC050E	557,40	DKDFNC050F	636,10	DKDFNC050P	650,33
63	DKDF/CP NC	50	DKDFNC063E	761,21	DKDFNC063F	894,93	DKDFNC063P	893,00
75	DKDF/CP NC	65	DKDFNC075E	913,44	DKDFNC075F	1.073,93	DKDFNC075P	1.071,59
90	VMDF/CP NC	80	VMDFNC090E	1.787,61	VMDFNC090F	2.137,23	VMDFNC090P	1.950,57
110	VMDF/CP NC	100	VMDFNC110E	2.248,30	VMDFNC110F	2.581,83	VMDFNC110P	2.513,21

Válvula neumática **NORMALMENTE CERRADA.**

M-M soldar socket.

**DK/CP NO****VM/CP NO**

d	Modelo	DN	€		€		L	€
			Ref. EPDM	EPDM	Ref. FKM	FKM		
20	DKDF/CP NO	15	DKDFNO020E	220,89	DKDFNO020F	259,62	DKDFNO020P	273,76
25	DKDF/CP NO	20	DKDFNO025E	232,09	DKDFNO025F	270,78	DKDFNO025P	285,69
32	DKDF/CP NO	25	DKDFNO032E	254,26	DKDFNO032F	406,22	DKDFNO032P	425,56
40	DKDF/CP NO	32	DKDFNO040E	412,46	DKDFNO040F	506,24	DKDFNO040P	530,02
50	DKDF/CP NO	40	DKDFNO050E	469,45	DKDFNO050F	572,11	DKDFNO050P	600,24
63	DKDF/CP NO	50	DKDFNO063E	605,16	DKDFNO063F	775,05	DKDFNO063P	772,62
75	DKDF/CP NO	65	DKDFNO075E	726,17	DKDFNO075F	930,05	DKDFNO075P	927,13
90	VMDF/CP NO	80	VMDFNO090E	1.571,76	VMDFNO090F	1.978,59	VMDFNO090P	1.760,76
110	VMDF/CP NO	100	VMDFNO110E	1.976,84	VMDFNO110F	2.249,59	VMDFNO110P	2.268,68

Válvula neumática **NORMALMENTE ABIERTA.**

M-M soldar socket.

**DK/CP DE****VM/CP DE**

d	Modelo	DN	€		€		L	€
			Ref. EPDM	EPDM	Ref. FKM	FKM		
20	DKDF/CP DE	15	DKDFDA020E	183,33	DKDFDA020F	222,05	DKDFDA020P	236,21
25	DKDF/CP DE	20	DKDFDA025E	194,51	DKDFDA025F	233,22	DKDFDA025P	248,12
32	DKDF/CP DE	25	DKDFDA032E	302,46	DKDFDA032F	364,42	DKDFDA032P	382,69
40	DKDF/CP DE	32	DKDFDA040E	374,99	DKDFDA040F	460,21	DKDFDA040P	481,83
50	DKDF/CP DE	40	DKDFDA050E	426,77	DKDFDA050F	520,10	DKDFDA050P	545,68
63	DKDF/CP DE	50	DKDFDA063E	550,13	DKDFDA063F	704,59	DKDFDA063P	702,37
75	DKDF/CP DE	65	DKDFDA075E	660,16	DKDFDA075F	845,50	DKDFDA075P	842,85
90	VMDF/CP DE	80	VMDFDA090E	1.744,70	VMDFDA090F	2.151,52	VMDFDA090P	1.933,73
110	VMDF/CP DE	100	VMDFDA110E	2.194,38	VMDFDA110F	2.446,26	VMDFDA110P	2.491,50

Válvula neumática **DOBLE EFECTO**

M-M soldar socket.



DK/CP NC

d	Modelo	DN	Ref. EPDM	€ EPDM	Ref. FKM	€ FKM	Ref. PTFE	L € PTFE
20	DKUIF/CP NC	15	DKUIFNC020E	291,96	DKUIFNC020F	329,97	DKUIFNC020P	344,85
25	DKUIF/CP NC	20	DKUIFNC025E	306,85	DKUIFNC025F	345,61	DKUIFNC025P	360,51
32	DKUIF/CP NC	25	DKUIFNC032E	388,20	DKUIFNC032F	431,14	DKUIFNC032P	449,53
40	DKUIF/CP NC	32	DKUIFNC040E	580,10	DKUIFNC040F	653,71	DKUIFNC040P	673,00
50	DKUIF/CP NC	40	DKUIFNC050E	665,47	DKUIFNC050F	744,15	DKUIFNC050P	759,33
63	DKUIF/CP NC	50	DKUIFNC063E	911,02	DKUIFNC063F	1.044,65	DKUIFNC063P	1.042,76

Válvula neumática **NORMALMENTE CERRADA.**

Con enlaces H-H para soldar socket.



DK/CP NO

d	Modelo	DN	Ref. EPDM	€ EPDM	Ref. FKM	€ FKM	Ref. PTFE	L € PTFE
20	DKUIF/CP NO	15	DKUIFNO020E	254,38	DKUIFNO020F	292,40	DKUIFNO020P	307,28
25	DKUIF/CP NO	20	DKUIFNO025E	269,29	DKUIFNO025F	308,04	DKUIFNO025P	322,94
32	DKUIF/CP NO	25	DKUIFNO032E	413,39	DKUIFNO032F	480,24	DKUIFNO032P	498,97
40	DKUIF/CP NO	32	DKUIFNO040E	522,07	DKUIFNO040F	617,01	DKUIFNO040P	639,59
50	DKUIF/CP NO	* 40	DKUIFNO050E	608,81	DKUIFNO050F	711,49	DKUIFNO050P	739,72
63	DKUIF/CP NO	* 50	DKUIFNO063E	797,05	DKUIFNO063F	968,18	DKUIFNO063P	965,78

Válvula neumática **NORMALMENTE ABIERTA.**

Con enlaces H-H para soldar socket.

* Válvulas NO-DE



DK/CP DE

d	Modelo	DN	Ref. EPDM	€ EPDM	Ref. FKM	€ FKM	Ref. PTFE	L € PTFE
20	DKUIF/CP DE	15	DKUIFDA020E	216,83	DKUIFDA020F	254,83	DKUIFDA020P	269,72
25	DKUIF/CP DE	20	DKUIFDA025E	231,72	DKUIFDA025F	270,48	DKUIFDA025P	285,37
32	DKUIF/CP DE	25	DKUIFDA032E	370,87	DKUIFDA032F	433,40	DKUIFDA032P	451,14
40	DKUIF/CP DE	32	DKUIFDA040E	474,62	DKUIFDA040F	560,92	DKUIFDA040P	581,44
50	DKUIF/CP DE	40	DKUIFDA050E	553,45	DKUIFDA050F	646,82	DKUIFDA050P	672,36
63	DKUIF/CP DE	50	DKUIFDA063E	363,49	DKUIFDA063F	880,16	DKUIFDA063P	877,97

Válvula neumática **DOBLE EFECTO.**

Con enlaces H-H para soldar socket.



DK/CP NC



VM/CP NC

d	Modelo	DN	Ref. EPDM	€ EPDM	Ref. FKM	€ FKM	Ref. PTFE	L € PTFE
20	DKOF/CP NC	15	DKOFNC020E	335,99	DKOFNC020F	374,74	DKOFNC020P	388,89
25	DKOF/CP NC	20	DKOFNC025E	350,54	DKOFNC025F	389,25	DKOFNC025P	404,15
32	DKOF/CP NC	25	DKOFNC032E	431,75	DKOFNC032F	474,68	DKOFNC032P	492,22
40	DKOF/CP NC	32	DKOFNC040E	643,64	DKOFNC040F	717,27	DKOFNC040P	736,53
50	DKOF/CP NC	40	DKOFNC050E	724,64	DKOFNC050F	803,33	DKOFNC050P	817,58
63	DKOF/CP NC	50	DKOFNC063E	989,59	DKOFNC063F	1.123,29	DKOFNC063P	1.121,36
75	DKOF/CP NC	65	DKOFNC075E	1.187,49	DKOFNC075F	1.347,94	DKOFNC075P	1.345,63
90	VMOF/CP NC	80	VMOFNC090E	2.109,37	VMOFNC090F	2.458,97	VMOFNC090P	2.272,33
110	VMOF/CP NC	100	VMOFNC110E	2.653,02	VMOFNC110F	2.985,93	VMOFNC110P	2.917,70

Válvula neumática **NORMALMENTE CERRADA.**

Con bridas DIN.

Disponibles con bridas ANSI 150 libras al mismo precio



DK/CP NO



VM/CP NO

d	Modelo	DN	Ref. EPDM	€ EPDM	Ref. FKM	€ FKM	Ref. PTFE	L € PTFE
20	DKOF/CP NO	15	DKOFNO020E	298,41	DKOFNO020F	337,17	DKOFNO020P	351,32
25	DKOF/CP NO	20	DKOFNO025E	312,97	DKOFNO025F	351,68	DKOFNO025P	366,58
32	DKOF/CP NO	25	DKOFNO032E	462,14	DKOFNO032F	528,37	DKOFNO032P	547,71
40	DKOF/CP NO	32	DKOFNO040E	575,88	DKOFNO040F	669,63	DKOFNO040P	693,39
50	DKOF/CP NO	40	DKOFNO050E	653,38	DKOFNO050F	756,11	DKOFNO050P	784,19
63	DKOF/CP NO	50	DKOFNO063E	856,34	DKOFNO063F	1.026,28	DKOFNO063P	1.023,82
75	DKOF/CP NO	65	DKOFNO075E	1.027,61	DKOFNO075F	1.231,53	DKOFNO075P	1.228,59
90	VMOF/CP NO	80	VMOFNO090E	1.893,51	VMOFNO090F	2.300,35	VMOFNO090P	2.082,54
110	VMOF/CP NO	100	VMOFNO110E	2.381,50	VMOFNO110F	2.541,22	VMOFNO110P	2.673,98

Válvula neumática **NORMALMENTE ABIERTA.**

Con bridas DIN.

Disponibles con bridas ANSI 150 libras al mismo precio



DK/CP DE



VM/CP DE

d	Modelo	DN	Ref. EPDM	€ EPDM	Ref. FKM	€ FKM	Ref. PTFE	L € PTFE
20	DKOF/CP DE	15	DKOFDA020E	260,85	DKOFDA020F	299,60	DKOFDA020P	313,75
25	DKOF/CP DE	20	DKOFDA025E	275,40	DKOFDA025F	314,11	DKOFDA025P	329,01
32	DKOF/CP DE	25	DKOFDA032E	417,16	DKOFDA032F	479,14	DKOFDA032P	497,39
40	DKOF/CP DE	32	DKOFDA040E	523,52	DKOFDA040F	608,75	DKOFDA040P	630,36
50	DKOF/CP DE	40	DKOFDA050E	593,98	DKOFDA050F	687,37	DKOFDA050P	712,89
63	DKOF/CP DE	50	DKOFDA063E	778,49	DKOFDA063F	932,98	DKOFDA063P	930,74
75	DKOF/CP DE	65	DKOFDA075E	934,20	DKOFDA075F	1.119,58	DKOFDA075P	1.116,90
90	VMOF/CP DE	80	VMOFDA090E	2.066,48	VMOFDA090F	2.473,29	VMOFDA090P	2.255,48
110	VMOF/CP DE	100	VMOFDA110E	2.599,07	VMOFDA110F	2.732,28	VMOFDA110P	2.896,06

Válvula neumática **DOBLE EFECTO.**

Con bridas DIN.

Disponibles con bridas ANSI 150 libras al mismo precio

CMDF/CP NC *M-M para fusión socket*
CMIF/CP NC *H-H para fusión socket*
CMUIF/CP NC *H-H enlaces fusión socket*
CMFF/CP NC *H-H roscar.*



L

d-Rh	Ref. EPDM	DN	€ EPDM	€ FKM	€ PTFE
20	CMDFNC020E	15	147,19	158,61	162,08
16	CMIFNC016E	12	118,28	134,94	140,20
20	CMIFNC020E	15	127,93	143,71	149,87
20	CMUIFNC020E	15	173,45	190,15 (A)	196,28
3/8"	CMFFNC038E	12	120,04	134,07	140,20
1/2"	CMFFNC012E	15	127,93	143,71	149,87

Válvula de membrana compacta neumática
NORMALMENTE CERRADA.

Código en FKM termina en "F" en lugar de "E"
 Código en PTFE termina en "P" en lugar de "E"
 (A) = Juntas en FKM

CMDF/CP NO *M-M para fusión socket*
CMIF/CP NO *H-H para fusión socket*
CMUIF/CP NO *H-H enlaces fusión socket*
CMFF/CP NO *H-H roscar.*



L

d-Rh	Ref. EPDM	DN	€ EPDM	€ FKM	€ PTFE
20	CMDFNO020E	15	144,60	156,87	159,47
16	CMIFNO016E	12	115,68	134,07	138,47
20	CMIFNO020E	15	125,31	142,86	148,13
20	CMUIFNO020E	15	172,62	189,25 (A)	194,52
3/8"	CMFFNO038E	12	118,28	133,21	138,47
1/2"	CMFFNO012E	15	125,31	142,86	148,13

Válvula de membrana compacta neumática
NORMALMENTE ABIERTA.

Código en FKM termina en "F" en lugar de "E"
 Código en PTFE termina en "P" en lugar de "E"
 (A) = Juntas en FKM

CMDF/CP DE *M-M para fusión socket*
CMIF/CP DE *H-H para fusión socket*
CMUIF/CP DE *H-H enlaces fusión socket*
CMFF/CP DE *H-H roscar.*



L

d-Rh	Ref. EPDM	DN	€ EPDM	€ FKM	€ PTFE
20	CMDFDA020E	15	144,60	156,87	159,47
16	CMIFDA016E	12	115,68	134,07	138,47
20	CMIFDA020E	15	125,31	142,86	148,13
20	CMUIFDA020E	15	172,62	189,25 (A)	194,52
3/8"	CMFFDA038E	12	118,28	133,21	138,47
1/2"	CMFFDA012E	15	125,31	142,86	148,13

Válvula de membrana compacta neumática
DOBLE EFECTO.

Código en FKM termina en "F" en lugar de "E"
 Código en PTFE termina en "P" en lugar de "E"
 (A) = Juntas en FKM

**VSF**

d	Ref.	DN	PN	L € PTFE
16	VSFBF016P	10	10	951,78
20	VSFBF020P	15	10	972,15
25	VSFBF025P	20	10	1.299,69
32	VSFBF032P	25	10	1.538,59
40	VSFBF040P	32	10	2.354,38
50	VSFBF050P	40	10	2.826,42
63	VSFBF063P	50	10	3.020,14

Válvula de sobrepresión-alivio. **Rango de calibración: 0,5 - 10 bars**
M-M para soldadura a testa.

**VCP**

d	Ref.	DN	PN	L € PTFE
16	VCPBF016P	10	10	841,98
20	VCPBF020P	15	10	852,22
25	VCPBF025P	20	10	1.180,96
32	VCPBF032P	25	10	1.319,59
40	VCPBF040P	32	10	2.022,47
50	VCPBF050P	40	10	2.624,84
63	VCPBF063P	50	10	2.624,84

Válvula retenedora de presión. **Rango de calibración: 0,5 - 10 bars**
M-M para soldadura a testa.

**VPR**

d	Ref.	DN	PN	L € FKM
16	VPRBF016F	10	10	1.006,65
20	VPRBF020F	15	10	1.079,96
25	VPRBF025F	20	10	1.502,42
32	VPRBF032F	25	10	1.706,13
40	VPRBF040F	32	10	1.861,75
50	VPRBF050F	40	10	2.006,47
63	VPRBF063F	50	10	6.779,55

Válvula reductora de presión. **Rango de calibración: 0,5 - 9 bars**
M-M para soldadura a testa.

**VPR**

d	Ref.	DN	PN	L € FKM
16	VPRDF016E	10	10	1.006,65
20	VPRDF020E	15	10	1.079,96
25	VPRDF025E	20	10	1.502,42
32	VPRDF032E	25	10	1.706,13
40	VPRDF040E	32	10	1.861,75
50	VPRDF050E	40	10	2.006,47
63	VPRDF063E	50	10	6.779,55

Válvula reductora de presión. **Rango de calibración: 0,5 - 9 bars**
M-M para fusión socket.



INDUSTRIA

Sistema PVDF

Conectores

**MANGUITO**

Y

d	Ref.	Para válvulas	€
16	ENDIF016	VKD-VKR-SR	21,12
20	ENDIF020	VKD-VKR-SR	21,12
25	ENDIF025	VKD-VKR-SR	27,51
32	ENDIF032	VKD-VKR-SR	36,98
40	ENDIF040	VKD-VKR-SR	48,08
50	ENDIF050	VKD-VKR-SR	56,92
63	ENDIF063	VKD-VKR-SR	86,80
75	ENDIF075	VKD	184,79
90	ENDIF090	VKD	289,69
110	ENDIF110	VKD	511,78

Conector final en PVDF.
H para soldar socket.

MANGUITO

Y

d	Ref.	Para válvulas	€
20	ENDDF020	VKD-VKR-SR	21,12
25	ENDDF025	VKD-VKR-SR	27,51
32	ENDDF032	VKD-VKR-SR	36,98
40	ENDDF040	VKD-VKR-SR	48,08
50	ENDDF050	VKD-VKR-SR	56,92
63	ENDDF063	VKD-VKR-SR	86,80
75	ENDDF075	VKD	184,79
90	ENDDF090	VKD	289,69
110	ENDDF110	VKD	511,78

Conector final en PVDF.
M para soldar socket.

**MANGUITO**

Y

Rh	Ref.	Para válvulas	€
½"	ENDFF012	VKD-VKR-SR	21,12
¾"	ENDFF034	VKD-VKR-SR	27,51
1"	ENDFF100	VKD-VKR-SR	36,98
1¼"	ENDFF114	VKD-VKR-SR	48,08
1½"	ENDFF112	VKD-VKR-SR	56,92
2"	ENDFF200	VKD-VKR-SR	86,80

Conector final en PVDF.
H rosca GAS.

CVDF

Y

d	Ref.	Para válvulas	€
20	CVDF21020	VKD-VKR-SR	16,76
25	CVDF21025	VKD-VKR-SR	20,98
32	CVDF21032	VKD-VKR-SR	22,47
40	CVDF21040	VKD-VKR-SR	28,00
50	CVDF21050	VKD-VKR-SR	41,36
63	CVDF21063	VKD-VKR-SR	55,89
75	CVDF21075	VKD	152,67
90	CVDF21090	VKD	192,25
110	CVDF21110	VKD	280,24

Conector final en PVDF SDR21 PN16.
Para soldar a testa o electrofusión.

**CVDF**

Y

d	Ref.	Para válvulas	€
20	QBBFL21020	CM-DK	21,34
25	QBBFL21025	CM-DK	26,70
32	QBBFL21032	CM-DK	28,60
40	QBBFL21040	CM-DK	35,64
50	QBBFL21050	CM-DK	52,64
63	QBBFL21063	CM-DK	71,14

Conector final en PVDF SDR21 PN16.
Para soldar a testa o electrofusión.

MANGUITO

Y

Rh	Ref.	Para válvulas	€
½"	ENDNF012	VKD-VKR-SR	21,12
¾"	ENDNF034	VKD-VKR-SR	27,51
1"	ENDNF100	VKD-VKR-SR	36,98
1¼"	ENDNF114	VKD-VKR-SR	48,08
1½"	ENDNF112	VKD-VKR-SR	56,92
2"	ENDNF200	VKD-VKR-SR	86,80

Conector final en PVDF.
H rosca NPT.

Tubo y accesorios
Válvulas manuales
Válvulas actuadas

Sistema C-PVC

INDUSTRIA





Sistema C-PVC





INDUSTRIA

Sistema C-PVC

Tubo y accesorios



B1

d	Ref.	PN	€/m.
16	PIPEC13016	16	2,56
20	PIPEC13020	16	3,78
25	PIPEC13025	16	5,94
32	PIPEC13032	16	9,62
40	PIPEC13040	16	14,79
50	PIPEC13050	16	22,57
63	PIPEC13063	16	36,13
75	PIPEC13075	16	51,17
90	PIPEC13090	16	72,68
110	PIPEC13110	16	108,79
110	PIPEC21110	10	66,33
160	PIPEC13160	16	245,63
160	PIPEC21160	10	171,64
225	PIPEC21225	10	470,02

Tubo en C-PVC SDR 13,5

Barras de 5 m.



B1

HIC

d	Ref.	Pack	€
20	HIC020	10	3,45
25	HIC025	10	4,84
32	HIC032	10	5,88
40	HIC040	5	8,49
50	HIC050	5	13,60
63	HIC063	5	20,77
75	HIC075	-	31,99
90	HIC090	-	47,39
110	HIC110	-	77,23
160	HIC160	-	166,06
225*	HIC225	-	544,11

Codo 45°.

H-H encolar.

* PN10



B1

GIC

d	Ref.	Pack	€
16	GIC016	10	2,57
20	GIC020	10	2,89
25	GIC025	10	3,62
32	GIC032	10	4,31
40	GIC040	10	5,64
50	GIC050	5	9,83
63	GIC063	2	12,26
75	GIC075	-	23,39
90	GIC090	-	31,36
110	GIC110	-	57,50
160	GIC160	-	143,72
225*	GIC225	-	715,64

Codo 90°.

H-H encolar.

* PN10



B1

TIC

d	Ref.	Pack	€
16	TIC016	10	2,67
20	TIC020	10	3,21
25	TIC025	10	3,99
32	TIC032	10	4,84
40	TIC040	5	6,66
50	TIC050	5	11,19
63	TIC063	2	15,17
75	TIC075	-	31,36
90	TIC090	-	45,20
110	TIC110	-	69,75
160	TIC160	-	216,13
225*	TIC225	-	848,06

Te a 90°.

H-H-H encolar.

* PN10



TRIC

B1

d x dr	Ref.	Pack	€
25 x 20	TRIC025020	10	3,45
32 x 20	TRIC032020	10	5,88
32 x 25	TRIC032025	10	5,88
40 x 20	TRIC040020	10	8,26
40 x 25	TRIC040025	10	8,26
50 x 25	TRIC050025	10	13,60
50 x 32	TRIC050032	10	13,60
63 x 25	TRIC063025	5	19,72
63 x 32	TRIC063032	5	19,72
75 x 25	TRIC075025	-	37,96
90 x 25	TRIC090025	-	47,24
110 x 25	TRIC110025	-	60,59

Te a 90° reducida.
H-H-H encolar.



TIMC

B1

d x Rh	Ref.	Pack	€
16 x 3/8"	TIMC016038	10	5,88
20 x 1/2"	TIMC020012	10	6,40
25 x 3/4"	TIMC025034	10	6,66
32 x 1"	TIMC032100	10	8,26
40 x 1 1/4"	TIMC040114	10	10,05
50 x 1 1/2"	TIMC050112	10	15,42
63 x 2"	TIMC063200	5	19,20

Te a 90° mixta reforzada inox.
H-H-H encolar-rosca.



MIMC

B1

d x Rh	Ref.	Pack	€
16 x 3/8"	MIMC016038	10	3,78
20 x 1/2"	MIMC020012	10	3,99
25 x 3/4"	MIMC025034	10	4,50
32 x 1"	MIMC032100	10	5,61
40 x 1 1/4"	MIMC040114	5	7,71
50 x 1 1/2"	MIMC050112	5	10,05
63 x 2"	MIMC063200	5	13,32

Manguito mixto reforzado inox.
H-H encolar-rosca.



MIC

B1

d	Ref.	Pack	€
16	MIC016	10	1,86
20	MIC020	10	2,15
25	MIC025	10	2,40
32	MIC032	10	2,94
40	MIC040	5	3,21
50	MIC050	5	5,35
63	MIC063	2	8,26
75	MIC075	-	12,26
90	MIC090	-	20,77
110	MIC110	-	37,79
160	MIC160	-	88,32
225*	MIC225	-	394,60

Manguito.
H-H encolar.

* PN10



GIMC

B1

d x Rh	Ref.	Pack	€
16 x 3/8"	GIMC016038	10	3,91
20 x 1/2"	GIMC020012	10	4,67
25 x 3/4"	GIMC025034	10	5,35
32 x 1"	GIMC032100	10	7,71
40 x 1 1/4"	GIMC040114	10	9,55
50 x 1 1/2"	GIMC050112	10	13,83
63 x 2"	GIMC063200	5	18,68

Codo a 90° mixto reforzado inox.
H-H encolar-rosca.



KIFC

B1

dm x dh x Rm	Ref.	Pack	€
20 x 16 x 3/8"	KIFC20016038	10	3,21
25 x 20 x 1/2"	KIFC25020012	10	3,75
32 x 25 x 3/4"	KIFC32025034	10	3,99
40 x 32 x 1"	KIFC40032100	10	4,84
50 x 40 x 1 1/4"	KIFC50040114	5	5,88
63 x 50 x 1 1/2"	KIFC63050112	5	6,93
75 x 63 x 2"	KIFC75063200	-	11,74

Terminal rosca macho.
M-H encolar - M rosca



DIC

B1

dm x dh	Ref.	Pack	€
20 x 16	DIC020016	10	2,22
25 x 20	DIC025020	10	2,57
32 x 20	DIC032020	10	2,98
32 x 25	DIC032025	10	2,98
40 x 20	DIC040020	10	4,84
40 x 25	DIC040025	10	4,84
40 x 32	DIC040032	10	4,84
50 x 32	DIC050032	10	4,98
50 x 40	DIC050040	10	4,98
63 x 32	DIC063032	5	7,91
63 x 40	DIC063040	5	7,91
63 x 50	DIC063050	5	7,91
75 x 50	DIC075050	5	12,55
75 x 63	DIC075063	-	12,55
90 x 50	DIC090050	-	17,54
90 x 63	DIC090063	-	17,54
90 x 75	DIC090075	-	17,54
110 x 63	DIC110063	-	26,94
110 x 75	DIC110075	-	26,94
110 x 90	DIC110090	-	26,94
160 x 110	DIC160110	-	66,52
225 x 160*	DIC225160	-	272,30

Casquillo reducción.

* PN10

M-H encolar.



CIC

B1

d	Ref.	Pack	€
20	CIC020	10	2,16
25	CIC025	10	3,50
32	CIC032	10	4,58
40	CIC040	10	6,08
50	CIC050	10	9,70
63	CIC063	5	11,19
75	CIC075	-	17,69
90	CIC090	-	25,22
110	CIC110	-	33,89

Tapón hembra.

H encolar.



B1

d	Producto	€
TG724	1) Cola TEMPERGLUE 724	34,08
PCP70	1) Decapante Primer Cleaner P70	14,36
TGBISON	2) Cola TEMPERGLUE 100	34,08
PCBISON	2) Decapante TEMPERFIP 100	14,36

Cola y decapante.

Todas las latas son de 500 g.

- 1) TEMPERGLUE 724 debe utilizarse con PRIMER CLEANER P70. Cola especialmente recomendable para la unión de piezas de C-PVC en contacto con fluidos químicamente agresivos (como ácidos y bases)
- 2) TEMPERGLUE 100 debe utilizarse con TEMPERFIP 100.



QRC

B1

d	Ref.	DN	Pack	€
20	QRC020	15	10	3,47
25	QRC025	20	10	4,27
32	QRC032	25	10	5,08
40	QRC040	32	5	5,88
50	QRC050	40	5	6,15
63	QRC063	50	2	7,43
75	QRC075	65	-	11,19
90	QRC090	80	-	16,46
110	QRC110	100	-	25,56
160	QRC160	150	-	88,32
225*	QRC225	200	-	341,12

Manguito portabridas.

* PN10

H encolar. Para usar con brida ODC.



ODC

B1

d	Ref.	DN	Pack	€
20	ODC020	15	2	4,27
25	ODC025	20	2	5,08
32	ODC032	25	2	5,88
40	ODC040	32	2	7,20
50	ODC050	40	2	9,30
63	ODC063	50	2	10,35
75	ODC075	65	2	15,42
90	ODC090	80	2	17,03
110	ODC110	100	2	23,39

Brida loca.

UNI 2223 PN10/16. Para usar con portabridas QRC.



ODB

T1

d	Ref.	DN	€
20	ODB020	15	7,15
25	ODB025	20	7,86
32	ODB032	25	10,13
40	ODB040	32	12,28
50	ODB050	40	14,36
63	ODB063	50	17,85
75	ODB075	65	19,73
90	ODB090	80	23,50
**125	ODB125	100	28,36

Brida loca.

En PP con alma de acero.

PN10. Para manguito portabridas.

Versión ANSI 150 lbs (ver OAB página 370)

Más diámetros en página 370
** Para usar con portabridas QRNM110

**BIC**

d	Ref. EPDM	Pack	€ EPDM	B1 € FKM
16	BIC016E	10	9,55	12,71
20	BIC020E	10	10,69	13,84
25	BIC025E	10	11,50	15,45
32	BIC032E	10	13,83	18,97
40	BIC040E	10	18,68	26,23
50	BIC050E	10	25,84	34,53
63	BIC063E	2	36,71	46,37

Unión 3 piezas.

Junta en EPDM ó FKM.

H-H encolar.

Código en FKM termina en "F"
en lugar de "E"**BIFC**

d x Rh	Ref.	Pack	€ EPDM	B1 € FKM
16 x 3/8"	BIFC016038E	10	15,42	
20 x 1/2"	BIFC020012E	10	17,03	
25 x 3/4"	BIFC025034E	10	18,13	
32 x 1"	BIFC032100E	2	20,23	
40 x 1 1/4"	BIFC040114E	2	33,05	
50 x 1 1/2"	BIFC050112E	2	47,39	
63 x 2"	BIFC063200E	2	53,30	

Unión 3 piezas mixto.

Junta en EPDM.

H-H encolar-rosacar

**BIFOC**

d x Rh	Ref.	PN	Pack	U/	B1 € EPDM
16 x 3/8"	BIFOC016038E	16	50	100	19,81
20 x 1/2"	BIFOC020012E	16	40	80	23,79
25 x 3/4"	BIFOC025034E	16	20	40	31,37
32 x 1"	BIFOC032100E	16	14	28	37,05
40 x 1 1/4"	BIFOC040114E	16	8	16	51,73
50 x 1 1/2"	BIFOC050112E	16	4	8	63,23
63 x 2"	BIFOC063200E	16	-	12	82,81

Unión 3 piezas mixto C-PVC / Latón.

Junta en EPDM.

H-H encolar-rosacar latón.

**BIROC**

d x Rm	Ref.	PN	Pack	U/	B1 € EPDM
16 x 3/8"	BIROC016038E	16	50	100	21,54
20 x 1/2"	BIROC020012E	16	35	70	26,08
25 x 3/4"	BIROC025034E	16	15	30	32,96
32 x 1"	BIROC032100E	16	12	24	42,74
40 x 1 1/4"	BIROC040114E	16	8	16	60,75
50 x 1 1/2"	BIROC050112E	16	4	8	74,42
63 x 2"	BIROC063200E	16	-	10	93,78

Unión 3 piezas mixto C-PVC / Latón.

Junta en EPDM.

H-M encolar-rosacar latón.

**BIFXC**

d x Rh	Ref. EPDM	Pack	€ EPDM	B1 € FKM
16 x 3/8"	BIFXC016038E	50	48,52	49,96
20 x 1/2"	BIFXC020012E	40	51,59	54,37
25 x 3/4"	BIFXC025034E	20	55,18	59,21
32 x 1"	BIFXC032100E	14	64,65	68,53
40 x 1 1/4"	BIFXC040114E	8	88,19	96,50
50 x 1 1/2"	BIFXC050112E	4	102,34	113,21
63 x 2"	BIFXC063200E	-	132,19	141,63

Unión 3 piezas mixto

C-PVC / Inox A316L.

Junta en EPDM ó FKM.

H-H encolar-rosacar inox.

Código en FKM termina en "F"
en lugar de "E"**BIRXC**

d x Rm	Ref. EPDM	Pack	€ EPDM	B1 € FKM
16 x 3/8"	BIRXC016038E	50	50,43	52,78
20 x 1/2"	BIRXC020012E	35	52,87	56,49
25 x 3/4"	BIRXC025034E	15	57,28	61,92
32 x 1"	BIRXC032100E	12	67,09	71,21
40 x 1 1/4"	BIRXC040114E	8	91,27	99,66
50 x 1 1/2"	BIRXC050112E	4	107,38	116,58
63 x 2"	BIRXC063200E	-	157,31	166,48

Unión 3 piezas mixto

C-PVC / Inox A316L.

Junta en EPDM ó FKM.

H-M encolar-rosacar inox.

Código en FKM termina en "F"
en lugar de "E"

**VKDIC**

d	Ref. EPDM	DN	PN	C1	
				€ EPDM	€ FKM
16	VKDIC016E	10	16	56,94	73,99
20	VKDIC020E	15	16	56,94	73,99
25	VKDIC025E	20	16	61,79	79,90
32	VKDIC032E	25	16	73,99	90,00
40	VKDIC040E	32	16	86,19	101,63
50	VKDIC050E	40	16	104,53	128,30
63	VKDIC063E	50	16	132,17	166,06

Válvula de bola DUAL BLOCK®. Código en FKM termina en "F" en lugar de "E"
 Asiento PTFE (teflón). Bidireccional.
 H-H encolar.

**VKDOC**

d	Ref. EPDM	DN	PN	C1	
				€ EPDM	€ FKM
20	VKDOC020E	15	16	120,81	148,58
25	VKDOC025E	20	16	127,70	154,01
32	VKDOC032E	25	16	144,68	168,11
40	VKDOC040E	32	16	198,37	220,85
50	VKDOC050E	40	16	230,15	261,84
63	VKDOC063E	50	16	271,03	319,76

Válvula de bola DUAL BLOCK®. Código en FKM termina en "F" en lugar de "E"
 Asiento PTFE (teflón). Bidireccional.
 Con brida loca. **Versión con bridas ANSI 150 al mismo precio**

**VKDIC**

d	Ref. EPDM	DN	PN	C1	
				€ EPDM	€ FKM
75	VKDIC075E	65	16	387,26	500,87
90	VKDIC090E	80	16	508,08	642,46
110	VKDIC110E	100	16	613,03	747,43

Válvula de bola DUAL BLOCK®. Código en FKM termina en "F" en lugar de "E"
 Asiento PTFE (teflón). Bidireccional.
 H-H encolar.

**VKDOC**

d	Ref. EPDM	DN	PN	C1	
				€ EPDM	€ FKM
75	VKDOC075E	65	16	580,88	694,50
90	VKDOC090E	80	16	762,15	896,53
110	VKDOC110E	100	16	919,54	1.053,91

Válvula de bola DUAL BLOCK®. Código en FKM termina en "F" en lugar de "E"
 Asiento PTFE (teflón). Bidireccional.
 Con brida loca DIN y ANSI.



VKDDC

C1

d	Ref. EPDM	DN	PN	€ EPDM	€ FKM
20	VKDDC020E	15	16	65,46	82,55
25	VKDDC025E	20	16	70,82	84,12
32	VKDDC032E	25	16	85,18	102,10
40	VKDDC040E	32	16	99,00	114,44
50	VKDDC050E	40	16	114,44	143,19
63	VKDDC063E	50	16	148,68	184,74

Válvula de bola DUAL BLOCK®. Código en FKM termina en "F" en lugar de "E"

Asiento PTFE (teflón). Bidireccional.

M-M encolar.



VKDDC

C1

d	Ref. EPDM	DN	PN	€ EPDM	€ FKM
75	VKDDC075E	65	16	425,96	539,61
90	VKDDC090E	80	16	558,92	693,31
110	VKDDC110E	100	16	674,31	808,72

Válvula de bola DUAL BLOCK®. Código en FKM termina en "F" en lugar de "E"

Asiento PTFE (teflón). Bidireccional.

M-M encolar.



TKDIC

C1

d	Ref. EPDM	DN	PN	€ EPDM	€ FKM
16	TKDIC016E	10	16	108,21	117,12
20	TKDIC020E	15	16	108,21	117,12
25	TKDIC025E	20	16	117,39	129,25
32	TKDIC032E	25	16	140,53	155,25
40	TKDIC040E	32	16	173,94	195,22
50	TKDIC050E	40	16	193,43	229,18
63	TKDIC063E	50	16	246,01	291,15

Válvula de bola 3 vías DUAL BLOCK®. PASO T.

Asiento PTFE (teflón). H-H-H encolar.

Código en FKM termina en "F" en lugar de "E"

Disponemos de manguitos roscados para estas válvulas



VXEIC

C1

d	Ref. EPDM	DN	PN	U	€ EPDM	€ FKM
16	VXEIC016E	10	16	100	35,42	45,93
20	VXEIC020E	15	16	80	35,42	45,93
25	VXEIC025E	20	16	40	38,33	49,57
32	VXEIC032E	25	16	28	43,35	52,76
40	VXEIC040E	32	16	16	52,73	62,18
50	VXEIC050E	40	16	8	61,05	74,92
63	VXEIC063E	50	16	12	82,56	103,79

Válvula de bola maneta naranja.

Asiento PTFE (teflón). Bidireccional.

H-H encolar.

Código en FKM termina en "F" en lugar de "E"

Disponemos de manguitos roscados para estas válvulas



VXEIC

C1

d	Ref. EPDM	DN	PN	€ EPDM	€ FKM
75	VXEIC075E	65	16	254,18	300,31
90	VXEIC090E	80	16	328,40	384,31
110	VXEIC110E	100	16	462,36	552,47

Válvula de bola maneta naranja.

Asiento PTFE (teflón). Bidireccional.

H-H encolar.

Código en FKM termina en "F" en lugar de "E"

Disponemos de manguitos roscados para estas válvulas



LKDIC

C1

d	Ref. EPDM	DN	PN	€ EPDM	€ FKM
16	LKDIC016E	10	16	124,45	133,34
20	LKDIC020E	15	16	124,45	133,34
25	LKDIC025E	20	16	134,99	146,85
32	LKDIC032E	25	16	161,58	176,34
40	LKDIC040E	32	16	200,01	221,31
50	LKDIC050E	40	16	222,42	258,20
63	LKDIC063E	50	16	282,93	328,06

Válvula de bola 3 vías DUAL BLOCK®. PASO L.

Asiento PTFE (teflón). H-H-H encolar.

Código en FKM termina en "F" en lugar de "E"

Disponemos de manguitos roscados para estas válvulas

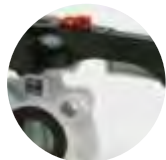

FKOC/FM

d	Ref. EPDM	DN	G	
			€ EPDM	€ FKM
50	FKOCFM050E	40	205,56	304,67
63	FKOCFM063E	50	217,66	322,55
75	FKOCFM075E	65	241,84	358,42
90	FKOCFM090E	80	262,89	384,69
110	FKOCFM110E	100	285,65	411,84
125	FKOCFM140E	125	379,44	551,18
140	FKOCFM140E	125	379,44	551,18
160	FKOCFM160E	150	418,87	589,76
200	FKOCFM225E	200	542,42	764,99
225	FKOCFM225E	200	542,42	764,99
250**	FKOCFM280E	250	1.728,23	2.750,09
280**	FKOCFM280E	250	1.728,23	2.750,09
315**	FKOCFM315E	300	1.884,28	2.999,02

Válvula de mariposa industrial.
A EJE LIBRE.

Para actuar. Cuerpo en PPGR,
eje inoxidable y disco en C-PVC.

Código en FKM termina en "F"
en lugar de "E"

** ANSI 150 lbs bajo pedido
al mismo precio.



FKOC/LM

d	Ref. EPDM	DN	G	
			€ EPDM	€ FKM
50	FKOCLM050E	40	241,34	338,16
63	FKOCLM063E	50	255,52	358,06
75	FKOCLM075E	65	283,90	397,83
90	FKOCLM090E	80	298,80	417,96
110	FKOCLM110E	100	324,23	446,90
125	FKOCLM140E	125	431,14	599,38
140	FKOCLM140E	125	431,14	599,38
160	FKOCLM160E	150	465,30	621,28
200	FKOCLM225E	200	601,98	805,29
225	FKOCLM225E	200	601,98	805,29

Válvula de mariposa industrial.
CON MANETA.

Cuerpo en PPGR,
eje inoxidable y disco en C-PVC.

Código en FKM termina en "F"
en lugar de "E"



FKOC/RM

d	Ref. EPDM	DN	G	
			€ EPDM	€ FKM
75	FKOCRM075E	65	637,05	750,96
90	FKOCRM090E	80	650,19	769,35
110	FKOCRM110E	100	677,37	799,16
125	FKOCRM140E	125	783,39	951,64
140	FKOCRM140E	125	783,39	951,64
160	FKOCRM160E	150	817,58	973,51
200	FKOCRM225E	200	1.034,90	1.237,31
225	FKOCRM225E	200	1.034,90	1.237,31
250**	FKOCRM280E	250	1.978,91	3.000,79
280**	FKOCRM280E	250	1.978,91	3.000,79
315**	FKOCRM315E	300	2.134,89	3.249,66

Válvula de mariposa industrial.
CON VOLANTE.

Cuerpo en PPGR,
eje inoxidable y disco en C-PVC.

Código en FKM termina en "F"
en lugar de "E"

** ANSI 150 lbs bajo pedido
al mismo precio.



FKOC/FM

d	Ref. EPDM	DN	G	
			€ EPDM	€ FKM
75	FKOLCFM075E	65	350,50	467,07
90	FKOLCFM090E	80	404,86	526,65
110	FKOLCFM110E	100	439,86	566,08
125	FKOLCFM140E	125	585,33	757,09
140	FKOLCFM140E	125	585,33	757,09
160	FKOLCFM160E	150	641,43	812,31
200	FKOLCFM225E	200	772,88	995,43
225	FKOLCFM225E	200	772,88	995,43

Válvula de mariposa industrial.
A EJE LIBRE. LUG ISO-DIN.

Para actuar. Cuerpo en PPGR,
eje inoxidable y disco en C-PVC.

Código en FKM termina en "F"
en lugar de "E"



FKOC/LM

d	Ref. EPDM	DN	G	
			€ EPDM	€ FKM
75	FKOLCLM075E	65	392,60	506,47
90	FKOLCLM090E	80	440,75	559,93
110	FKOLCLM110E	100	478,44	601,12
125	FKOLCLM140E	125	637,05	805,29
140	FKOLCLM140E	125	637,05	805,29
160	FKOLCLM160E	150	687,90	843,86
200	FKOLCLM225E	200	832,42	1.035,73
225	FKOLCLM225E	200	832,42	1.035,73

Válvula de mariposa industrial.
CON MANETA. LUG ISO-DIN.

Cuerpo en PPGR,
 eje inoxidable y disco en C-PVC.

Código en FKM termina en "F"
 en lugar de "E"



FKOC/RM

d	Ref. EPDM	DN	G	
			€ EPDM	€ FKM
75	FKOLCRM075E	65	745,69	859,60
90	FKOLCRM090E	80	792,15	911,32
110	FKOLCRM110E	100	831,60	953,39
125	FKOLCRM140E	125	989,29	1.157,55
140	FKOLCRM140E	125	989,29	1.157,55
160	FKOLCRM160E	150	1.040,14	1.196,08
200	FKOLCRM225E	200	1.265,33	1.467,73
225	FKOLCRM225E	200	1.265,33	1.467,73

Válvula de mariposa industrial.
CON VOLANTE. LUG ISO-DIN.

Cuerpo en PPGR,
 eje inoxidable y disco en C-PVC.

Código en FKM termina en "F"
 en lugar de "E"



FKOC/FM

d	Ref. EPDM	DN	G	
			€ EPDM	€ FKM
2½"	FKOALCFM212E	65	404,85	521,40
3"	FKOALCFM300E	80	461,79	583,57
4"	FKOALCFM400E	100	502,09	628,26
5"	FKOALCFM500E	125	667,73	839,46
6"	FKOALCFM600E	150	730,83	901,69
8"	FKOALCFM800E	200	887,64	1.110,21
10"	FKOALCFM810E	250	2.833,03	3.854,90
12"	FKOALCFM812E	300	3.014,37	4.129,13

Válvula de mariposa industrial.
A EJE LIBRE. LUG ANSI.

Para actuar. Cuerpo en PPGR,
 eje inoxidable y disco en C-PVC.

Código en FKM termina en "F"
 en lugar de "E"



FKOC/LM

d	Ref. EPDM	DN	G	
			€ EPDM	€ FKM
2½"	FKOALCLM212E	65	446,90	560,79
3"	FKOALCLM300E	80	497,71	616,90
4"	FKOALCLM400E	100	540,63	663,33
5"	FKOALCLM500E	125	719,41	887,68
6"	FKOALCLM600E	150	777,25	933,24
8"	FKOALCLM800E	200	947,20	1.150,51

Válvula de mariposa industrial.
CON MANETA. LUG ANSI.

Cuerpo en PPGR,
 eje inoxidable y disco en C-PVC.

Código en FKM termina en "F"
 en lugar de "E"



FKOC/FM

d	Ref. EPDM	DN	G	
			€ EPDM	€ FKM
2½"	FKOALCFM212E	65	800,02	913,97
3"	FKOALCFM300E	80	849,10	968,27
4"	FKOALCFM400E	100	893,80	1.015,59
5"	FKOALCFM500E	125	1.071,67	1.239,91

Válvula de mariposa industrial. **CON VOLANTE. LUG ANSI.**
 Cuerpo en PPGR, eje inoxidable y disco en C-PVC.

d	Ref. EPDM	DN	G	
			€ EPDM	€ FKM
6"	FKOALCFM600E	150	1.129,51	1.285,49
8"	FKOALCFM800E	200	1.380,10	1.582,52
10"	FKOALCFM810E	250	3.083,71	4.105,57
12"	FKOALCFM812E	300	3.265,01	4.379,78

Código en FKM termina en "F"
 en lugar de "E"

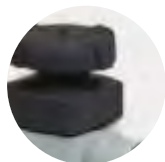

DKDC

d	Ref. EPDM	DN	PN	€ EPDM	€ FKM	€ PTFE	D1
20	DKDC020E	15	10	82,21	155,69	155,69	
25	DKDC025E	20	10	92,16	169,97	169,97	
32	DKDC032E	25	10	107,51	182,05	182,05	
40	DKDC040E	32	10	128,37	241,26	241,26	
50	DKDC050E	40	10	164,55	276,35	276,35	
63	DKDC063E	50	10	196,31	381,63	349,85	
75	DKDC075E	65	10	235,58	457,95	419,83	

Válvula de membrana
DIALOCK®.
M-M encolar.

Código en FKM termina en "F"
en lugar de "E"
Código en PTFE termina en "P"
en lugar de "E"



DKOC

d	Ref. EPDM	DN	PN	€ EPDM	€ FKM	€ PTFE	D1
20	DKOC020E	15	10	140,53	213,99	213,99	
25	DKOC025E	20	10	153,17	230,98	230,98	
32	DKOC032E	25	10	171,04	245,57	245,57	
40	DKOC040E	32	10	211,73	324,65	324,65	
50	DKOC050E	40	10	251,90	363,74	363,74	
63	DKOC063E	50	10	316,92	502,22	470,44	
75	DKOC075E	65	10	412,00	652,87	611,56	

Válvula de membrana
DIALOCK®.
Con bridas DIN.

Código en FKM termina en "F"
en lugar de "E"
Código en PTFE termina en "P"
en lugar de "E"



VMDC

d	Ref. EPDM	DN	€ EPDM	€ FKM	€ PTFE	D1
90	VMDC090E	80	528,55	943,09	730,36	
110	VMDC110E	100	747,87	1.469,46	996,77	

Válvula de membrana.
M-M encolar.

Código en FKM termina en "F"
en lugar de "E"
Código en PTFE termina en "P"
en lugar de "E"



VMOC

d	Ref. EPDM	DN	€ EPDM	€ FKM	€ PTFE	D1
90	VMOC090E	80	706,03	1.120,60	907,86	
110	VMOC110E	100	955,93	1.677,53	1.204,86	

Válvula de membrana.
Con bridas DIN. Bajo pedido
con bridas ANSI 150 lbs
al mismo precio.

Código en FKM termina en "F"
en lugar de "E"
Código en PTFE termina en "P"
en lugar de "E"



DKUIC

d	Ref. EPDM	DN	PN	€ EPDM	€ FKM	€ PTFE	D1
20	DKUIC020E	15	10	93,23	166,70	166,70	
25	DKUIC025E	20	10	104,19	182,05	182,05	
32	DKUIC032E	25	10	120,68	195,22	195,22	
40	DKUIC040E	32	10	149,12	262,10	262,10	
50	DKUIC050E	40	10	186,49	298,28	298,28	
63	DKUIC063E	50	10	230,32	415,63		

Válvula de membrana
DIALOCK®.
Con enlaces H-H para encolar.

Código en FKM termina en "F"
en lugar de "E"
Código en PTFE termina en "P"
en lugar de "E"



DKLDC

d	Ref. EPDM	DN	PN	€ EPDM	€ FKM	€ PTFE	D1
20	DKLDC020E	15	10	169,87	243,34	243,34	
25	DKLDC025E	20	10	179,82	257,61	257,61	
32	DKLDC032E	25	10	195,18	269,71	269,71	
40	DKLDC040E	32	10	216,02	328,92	328,92	
50	DKLDC050E	40	10	277,25	389,07	389,07	
63	DKLDC063E	50	10	309,01	494,33	462,55	
75	DKLDC075E	65	10	370,82	593,19	555,08	

Válvula de membrana
DIALOCK®. **CON LIMITADOR
DE CARRERA.**
M-M encolar.

Código en FKM termina en "F"
en lugar de "E"
Código en PTFE termina en "P"
en lugar de "E"



DKUFC

Rh	Ref. EPDM	DN	PN	€ EPDM	€ FKM	€ PTFE	D1
½"	DKUFC012E	15	10	102,00	176,10	174,53	
¾"	DKUFC034E	20	10	113,00	192,84	189,95	
1"	DKUFC100E	25	10	128,96	202,26	202,78	
1¼"	DKUFC114E	32	10	176,26	289,47	285,14	
1½"	DKUFC112E	40	10	215,49	326,05	324,82	
2"	DKUFC200E	50	10	257,95	444,03	409,20	

Válvula de membrana
DIALOCK®.
Con enlaces H-H para rosacar.

Código en FKM termina en "F"
en lugar de "E"
Código en PTFE termina en "P"
en lugar de "E"



DKLUIC

d	Ref. EPDM	DN	PN	€ EPDM	€ FKM	€ PTFE	D1
20	DKLUIC020E	15	10	180,89	254,35	254,35	
25	DKLUIC025E	20	10	191,84	269,71	269,71	
32	DKLUIC032E	25	10	208,34	282,89	282,89	
40	DKLUIC040E	32	10	236,78	349,77	349,77	
50	DKLUIC050E	40	10	299,20	410,99	410,99	
63	DKLUIC063E	50	10	343,02	528,33	496,58	

Válvula de membrana
DIALOCK®. **CON LIMITADOR
DE CARRERA.**

Código en FKM termina en "F"
en lugar de "E"
Código en PTFE termina en "P"
en lugar de "E"

Con enlaces H-H para encolar.



DKOAC

d	Ref. EPDM	DN	PN	€ EPDM	€ FKM	€ PTFE	D1
½"	DKOAC012E	15	10	140,53	213,99	213,99	
¾"	DKOAC034E	20	10	153,17	230,98	230,98	
1"	DKOAC100E	25	10	171,04	245,57	245,57	
1¼"	DKOAC114E	32	10	211,73	324,65	324,65	
1½"	DKOAC112E	40	10	251,90	363,74	363,74	
2"	DKOAC200E	50	10	316,92	502,22	470,44	
2½"	DKOAC212E	65	10	412,00	652,87	611,56	

Válvula de membrana
DIALOCK®.
Con bridas ANSI 150 lbs.

Código en FKM termina en "F"
en lugar de "E"
Código en PTFE termina en "P"
en lugar de "E"



CMDC

M-M encolar

CMUIC

H-H enlaces encolar

d	Ref. EPDM	DN	€ EPDM	€ FKM	€ PTFE	D1
20	CMDC020E	15	114,08	159,02	172,03	
20	CMUIC020E	15	131,60	168,91	175,44	

Válvula de membrana
compacta.

Código en FKM termina en "F"
en lugar de "E"
Código en PTFE termina en "P"
en lugar de "E"



RVUIC

d	Ref. EPDM	DN	PN	€ EPDM	€ FKM	C1
20	RVUIC020E	15	16	74,65	85,86	
25	RVUIC025E	20	16	80,64	94,52	
32	RVUIC032E	25	16	106,06	122,16	
40	RVUIC040E	32	16	121,33	151,33	
50	RVUIC050E	40	16	153,66	178,50	
63	RVUIC063E	50	16	200,44	224,92	

Filtro inclinado.
Juntas en EPDM o FKM.
H-H con enlaces para encolar.

Código en FKM termina en "F"
en lugar de "E"



SETFLOC

d DIN	d ANSI	Ref. DIN	€ DIN 2501	€ ANSI	C1
20	½"	SETFLOC020	35,66	35,66	
25	¾"	SETFLOC025	40,85	40,85	
32	1"	SETFLOC032	48,62	48,62	
40	1¼"	SETFLOC040	61,13	61,13	
50	1½"	SETFLOC050	65,94	65,95	
63	2"	SETFLOC063	83,76	83,76	
75	2½"	SETFLOC075		116,50	
90	3"	SETFLOC090		171,29	
110	4"	SETFLOC110		214,98	

Set embridado.
Compuesto por 1 brida, 1 anillo fijación y 1 tuerca.
Para Válvulas VKD / TKD / RVU.

d. 75-90-110,
es el mismo artículo
para DIN y ANSI



SSEIC

C1

d	Ref. EPDM	DN	PN	Pack	U/	€ EPDM	€ FKM
16	SSEIC016E	10	16	2	30	56,02	57,47
20	SSEIC020E	15	16	2	30	56,02	57,47
25	SSEIC025E	20	16	2	30	60,63	62,04
32	SSEIC032E	25	16	2	20	73,01	74,24
40	SSEIC040E	32	16	2	14	83,40	90,11
50	SSEIC050E	40	16	2	6	113,54	120,66
63	SSEIC063E	50	16	2	6	136,73	140,82
75	SSEIC075E	65	16	-	1	379,36	398,04
90	SSEIC090E	80	16	-	1	490,10	511,49
110	SSEIC110E	100	16	-	1	920,10	965,33

Válvula de retención
con muelle en INOX 316.

Código en FKM termina en "F"
en lugar de "E"

Juntas en EPDM o FKM. H-H encolar.



SSEAC

C1

d	Ref. EPDM	DN	PN	Pack	U/	€ EPDM	€ FKM
½"	SSEAC012E	10	16	2	30	56,02	57,47
¾"	SSEAC034E	15	16	2	30	60,63	62,04
1"	SSEAC100E	20	16	2	30	73,01	74,24
1¼"	SSEAC114E	25	16	2	20	83,40	90,11
1½"	SSEAC112E	32	16	2	14	113,54	120,66
2"	SSEAC200E	40	16	2	6	136,73	140,82
2½"	SSEAC212E	50	16	2	6	379,36	398,04
3"	SSEAC300E	65	16	-	1	490,10	511,49
4"	SSEAC400E	80	16	-	1	920,09	965,33

Válvula de retención
con muelle en INOX 316.
H-H encolar serie ASTM.

Código en FKM termina en "F"
en lugar de "E"

Juntas en EPDM o FKM..



SSEIC

C1

d	Ref. EPDM	DN	PN	Pack	U/	€ EPDM	€ FKM
16	SSEIC016EH	10	16	2	30	Consultar	Consultar
20	SSEIC020EH	15	16	2	30	Consultar	Consultar
25	SSEIC025EH	20	16	2	30	Consultar	Consultar
32	SSEIC032EH	25	16	2	20	Consultar	Consultar

Válvula de retención
con muelle en HASTELLOY.

Código en FKM termina en "F"
en lugar de "E"

Juntas en EPDM o FKM. H-H encolar.



SSEAC

C1

d	Ref. EPDM	DN	PN	Pack	U/	€ EPDM	€ FKM
½"	SSEAC012EH	15	16	2	30	Consultar	Consultar
¾"	SSEAC034EH	20	16	2	30	Consultar	Consultar
1"	SSEAC100EH	25	16	2	30	Consultar	Consultar

Válvula de retención
con muelle en HASTELLOY.
H-H encolar serie ASTM.

Código en FKM termina en "F"
en lugar de "E"

Juntas en EPDM o FKM..



SSEIC

C1

d	Ref. EPDM	DN	PN	Pack	U/	€ EPDM	€ FKM
40	SSEIC040EOP	32	16	2	2	Consultar	Consultar
50	SSEIC050EOP	40	16	2	2	Consultar	Consultar
63	SSEIC063EOP	50	16	2	2	Consultar	Consultar
75	SSEIC075EOP	65	16	-	1	Consultar	Consultar
90	SSEIC090EOP	80	16	-	1	Consultar	Consultar
110	SSEIC110EOP	100	16	-	1	Consultar	Consultar

Válvula de retención **con muelle en INOX recubierto PTFE.**

Código en FKM termina en "F"
en lugar de "E"

Juntas en EPDM o FKM. H-H encolar.



SSEAC

C1

d	Ref. EPDM	DN	PN	Pack	U/	€ EPDM	€ FKM
1¼"	SSEAC114EOP	32	16	2	2	Consultar	Consultar
1½"	SSEAC112EOP	40	16	2	2	Consultar	Consultar
2"	SSEAC200EOP	50	16	2	2	Consultar	Consultar
2½"	SSEAC212EOP	65	16	-	1	Consultar	Consultar
3"	SSEAC300EOP	80	16	-	1	Consultar	Consultar
4"	SSEAC400EOP	100	16	-	1	Consultar	Consultar

Válvula de retención **con muelle en INOX recubierto PTFE.**
H-H encolar serie ASTM.

Código en FKM termina en "F"
en lugar de "E"

Juntas en EPDM o FKM..



INDUSTRIA

Sistema C-PVC

Válvulas de bola actuadas



VKDIC/CE

Encolar



K

d	ACTUACIÓN ELÉCTRICA				ACTUACIÓN ELÉCTRICA CON BLOQUE DE SEGURIDAD			
	24-240 V AC/DC		24-240 V AC/DC		24-240 V AC/DC		24-240 V AC/DC	
	Ref.	€ EPDM	Ref.	€ FKM	Ref.	€ EPDM	Ref.	€ FKM
16	VKCE016E2D	609,82	VKCE016F2D	636,34	VKCE016E2BD	1.104,70	VKCE016F2BD	1.131,21
20	VKCE020E2D	609,82	VKCE020F2D	636,34	VKCE020E2BD	1.104,70	VKCE020F2BD	1.131,21
25	VKCE025E2D	619,90	VKCE025F2D	648,11	VKCE025E2BD	1.114,77	VKCE025F2BD	1.142,97
32	VKCE032E2D	638,93	VKCE032F2D	663,80	VKCE032E2BD	1.133,78	VKCE032F2BD	1.158,68
40	VKCE040E2D	664,30	VKCE040F2D	688,38	VKCE040E2BD	1.159,19	VKCE040F2BD	1.183,27
50	VKCE050E2D	692,90	VKCE050F2D	729,84	VKCE050E2BD	1.187,75	VKCE050F2BD	1.224,72
63	VKCE063E2D	739,03	VKCE063F2D	791,79	VKCE063E2BD	1.233,91	VKCE063F2BD	1.286,66
75	VKCE075E2D	1.313,39	VKCE075F2D	1.490,24	VKCE075E2BD	1.808,27	VKCE075F2BD	1.985,10
90	VKCE090E2D	1.501,43	VKCE090F2D	1.710,59	VKCE090E2BD	1.996,29	VKCE090F2BD	2.205,45
110	VKCE110E2D	2.001,70	VKCE110F2D	2.210,88	VKCE110E2BD	2.496,59	VKCE110F2BD	2.705,76

Válvula de bola motorizada en C-PVC 2 vías DUAL BLOCK®. Actuación eléctrica

Disponemos de otras conexiones bajo pedido: bridas, encolar macho y roscar (GAS, NPT). Bajo pedido podemos suministrar otros actuadores: VALPES, BELIMO... **Bajo pedido también disponibles en 12V AC/DC**



K

VKDIC/CP

Encolar

d	ACTUACIÓN NEUMÁTICA ALUMINIO				ACTUACIÓN NEUMÁTICA ALUMINIO CON ELECTROVÁLVULA, FINALES DE CARRERA (ELECTROMEQUÍNICOS) Y REGULADORES DE ESCAPE			
	DOBLE EFECTO		SIMPLE EFECTO		DOBLE EFECTO		SIMPLE EFECTO	
	Ref.	€	Ref.	€	Ref.	€	Ref.	€
16	VKCP016EDED	308,82	VKCP016ESED	336,21	VKCP016EDEFD	487,83	VKCP016ESEFD	524,69
20	VKCP020EDED	308,82	VKCP020ESED	336,21	VKCP020EDEFD	487,83	VKCP020ESEFD	524,69
25	VKCP025EDED	318,88	VKCP025ESED	346,28	VKCP025EDEFD	497,88	VKCP025ESEFD	534,73
32	VKCP032EDED	337,92	VKCP032ESED	365,29	VKCP032EDEFD	516,90	VKCP032ESEFD	553,75
40	VKCP040EDED	363,29	VKCP040ESED	390,70	VKCP040EDEFD	542,30	VKCP040ESEFD	579,15
50	VKCP050EDED	391,88	VKCP050ESED	472,49	VKCP050EDEFD	570,88	VKCP050ESEFD	660,94
63	VKCP063EDED	438,04	VKCP063ESED	589,02	VKCP063EDEFD	617,03	VKCP063ESEFD	777,48
75	VKCP075EDED	868,45	VKCP075ESED	975,28	VKCP075EDEFD	1.047,45	VKCP075ESEFD	1.163,74
90	VKCP090EDED	1.056,50	VKCP090ESED	1.163,32	VKCP090EDEFD	1.235,50	VKCP090ESEFD	1.351,78
110	VKCP110EDED	1.243,92	VKCP110ESED	1.622,01	VKCP110EDEFD	1.422,92	VKCP110ESEFD	1.810,45
16	VKCP016FDED	335,34	VKCP016FSED	362,75	VKCP016FDEFD	514,34	VKCP016FSEFD	551,19
20	VKCP020FDED	335,34	VKCP020FSED	362,75	VKCP020FDEFD	514,34	VKCP020FSEFD	551,19
25	VKCP025FDED	347,11	VKCP025FSED	374,49	VKCP025FDEFD	526,09	VKCP025FSEFD	562,96
32	VKCP032FDED	362,79	VKCP032FSED	390,19	VKCP032FDEFD	541,79	VKCP032FSEFD	578,64
40	VKCP040FDED	387,39	VKCP040FSED	414,77	VKCP040FDEFD	566,40	VKCP040FSEFD	603,21
50	VKCP050FDED	428,84	VKCP050FSED	509,45	VKCP050FDEFD	607,83	VKCP050FSEFD	697,91
63	VKCP063FDED	490,78	VKCP063FSED	641,77	VKCP063FDEFD	669,78	VKCP063FSEFD	830,22
75	VKCP075FDED	1.045,29	VKCP075FSED	1.152,12	VKCP075FDEFD	1.224,30	VKCP075FSEFD	1.340,58
90	VKCP090FDED	1.265,64	VKCP090FSED	1.372,47	VKCP090FDEFD	1.444,65	VKCP090FSEFD	1.560,92
110	VKCP110FDED	1.453,09	VKCP110FSED	1.831,17	VKCP110FDEFD	1.632,07	VKCP110FSEFD	2.019,60

Válvula de bola motorizada en C-PVC 2 vías DUAL BLOCK®. Actuación neumática.

Disponemos de otras conexiones bajo pedido: bridas, encolar macho y roscar (GAS, NPT). Las válvulas neumáticas se configuran NC (normalmente cerrada) de serie. La configuración NA (normalmente abierta) se debe especificar en el pedido



VKDIC/CP

Encolar

K

ACTUACIÓN NEUMÁTICA POLIAMIDA

ACTUACIÓN NEUMÁTICA POLIAMIDA CON ELECTROVÁLVULA, FINALES DE CARRERA (ELECTROMECÁNICOS) Y REGULADORES DE ESCAPE

d	DOBLE EFECTO		SIMPLE EFECTO		DOBLE EFECTO		SIMPLE EFECTO	
	Ref.	€	Ref.	€	Ref.	€	Ref.	€
16	VKCP016EDEP	325,52	VKCP016ESEP	346,17	VKCP016EDEF	559,68	VKCP016ESEFP	580,33
20	VKCP020EDEP	325,52	VKCP020ESEP	346,17	VKCP020EDEF	559,68	VKCP020ESEFP	580,33
25	VKCP025EDEP	335,61	VKCP025ESEP	356,25	VKCP025EDEF	569,75	VKCP025ESEFP	590,40
32	VKCP032EDEP	354,61	VKCP032ESEP	468,16	VKCP032EDEF	588,75	VKCP032ESEFP	702,28
40	VKCP040EDEP	380,02	VKCP040ESEP	493,53	VKCP040EDEF	614,16	VKCP040ESEFP	727,68
50	VKCP050EDEP	408,60	VKCP050ESEP	630,46	VKCP050EDEF	642,75	VKCP050ESEFP	864,60
63	VKCP063EDEP	636,82	VKCP063ESEP	696,15	VKCP063EDEF	870,97	VKCP063ESEFP	930,30
75	VKCP075EDEP	983,57	VKCP075ESEP	1.205,85	VKCP075EDEF	1.217,71	VKCP075ESEFP	1.440,01
90	VKCP090EDEP	1.171,61	VKCP090ESEP	1.393,89	VKCP090EDEF	1.405,76	VKCP090ESEFP	1.628,05
110	VKCP110EDEP	1.329,23	VKCP110ESEP	1.570,47	VKCP110EDEF	1.563,38	VKCP110ESEFP	1.804,63
16	VKCP016FDEP	352,07	VKCP016FSEP	372,72	VKCP016FDEF	586,20	VKCP016FSEFP	606,85
20	VKCP020FDEP	352,07	VKCP020FSEP	372,72	VKCP020FDEF	586,20	VKCP020FSEFP	606,85
25	VKCP025FDEP	363,83	VKCP025FSEP	384,46	VKCP025FDEF	597,97	VKCP025FSEFP	618,60
32	VKCP032FDEP	379,50	VKCP032FSEP	493,03	VKCP032FDEF	613,66	VKCP032FSEFP	727,17
40	VKCP040FDEP	404,08	VKCP040FSEP	517,62	VKCP040FDEF	638,24	VKCP040FSEFP	751,77
50	VKCP050FDEP	445,53	VKCP050FSEP	667,43	VKCP050FDEF	679,69	VKCP050FSEFP	901,58
63	VKCP063FDEP	689,57	VKCP063FSEP	748,89	VKCP063FDEF	923,70	VKCP063FSEFP	983,04
75	VKCP075FDEP	1.160,41	VKCP075FSEP	1.382,69	VKCP075FDEF	1.394,55	VKCP075FSEFP	1.616,84
90	VKCP090FDEP	1.380,76	VKCP090FSEP	1.603,04	VKCP090FDEF	1.614,90	VKCP090FSEFP	1.837,17
110	VKCP110FDEP	1.538,37	VKCP110FSEP	1.779,62	VKCP110FDEF	1.772,53	VKCP110FSEFP	2.013,78

Válvula de bola motorizada en C-PVC 2 vías DUAL BLOCK®. Actuación neumática

Disponemos de otras conexiones bajo pedido: bridas, encolar macho y roscar (GAS, NPT)
 Las válvulas neumáticas se configuran NC (normalmente cerrada) de serie.
 La configuración NA (normalmente abierta) se debe especificar en el pedido



INDUSTRIA

Sistema C-PVC

Válvulas de 3 vías actuadas



LKDIC/CE

Encolar

d	ACTUACIÓN ELÉCTRICA				ACTUACIÓN ELÉCTRICA CON BLOQUE DE SEGURIDAD			
	24-240 V AC/DC		24-240 V AC/DC		24-240 V AC/DC		24-240 V AC/DC	
	Ref.	€	Ref.	€	Ref.	€	Ref.	€
16	LKCE016E2D	714,86	LKCE016F2D	728,72	LKCE016E2BD	1.209,74	LKCE016F2BD	1.223,58
20	LKCE020E2D	714,86	LKCE020F2D	728,72	LKCE020E2BD	1.209,74	LKCE020F2BD	1.223,58
25	LKCE025E2D	733,83	LKCE025F2D	752,32	LKCE025E2BD	1.228,71	LKCE025F2BD	1.247,21
32	LKCE032E2D	775,22	LKCE032F2D	798,20	LKCE032E2BD	1.270,09	LKCE032F2BD	1.293,04
40	LKCE040E2D	841,47	LKCE040F2D	874,64	LKCE040E2BD	1.336,32	LKCE040F2BD	1.369,52
50	LKCE050E2D	876,31	LKCE050F2D	932,04	LKCE050E2BD	1.371,20	LKCE050F2BD	1.426,91
63	LKCE063E2D	973,71	LKCE063F2D	1.043,93	LKCE063E2BD	1.468,55	LKCE063F2BD	1.538,79

Válvula de bola motorizada en C-PVC 3 vías DUAL BLOCK®. Actuación eléctrica

Estándar paso en L, paso en T opcional, al mismo precio. Disponemos de otras conexiones bajo pedido: bridas, encolar macho y roscar (GAS, NPT) Bajo pedido podemos suministrar otros actuadores: VALPES, BELIMO...
Bajo pedido también disponibles en 12V AC/DC

LKDIC/CP

Encolar

d	ACTUACIÓN NEUMÁTICA ALUMINIO				ACTUACIÓN NEUMÁTICA ALUMINIO CON ELECTROVÁLVULA, FINALES DE CARRERA (ELECTROMECÁNICOS) Y REGULADORES DE ESCAPE			
	DOBLE EFECTO		SIMPLE EFECTO		DOBLE EFECTO		SIMPLE EFECTO	
	Ref.	€	Ref.	€	Ref.	€	Ref.	€
16	LKCP016EDED	413,85	LKCP016ESED	441,26	LKCP016EDEFD	592,87	LKCP016ESEFD	629,70
20	LKCP020EDED	413,85	LKCP020ESED	441,26	LKCP020EDEFD	592,87	LKCP020ESEFD	629,70
25	LKCP025EDED	432,82	LKCP025ESED	460,23	LKCP025EDEFD	611,83	LKCP025ESEFD	648,68
32	LKCP032EDED	474,21	LKCP032ESED	501,63	LKCP032EDEFD	653,22	LKCP032ESEFD	690,07
40	LKCP040EDED	540,48	LKCP040ESED	621,08	LKCP040EDEFD	719,46	LKCP040ESEFD	809,51
50	LKCP050EDED	607,23	LKCP050ESED	726,31	LKCP050EDEFD	786,22	LKCP050ESEFD	914,76
63	LKCP063EDED	704,59	LKCP063ESED	823,67	LKCP063EDEFD	883,58	LKCP063ESEFD	1012,12
16	LKCP016FDED	427,71	LKCP016FSED	455,10	LKCP016FDEFD	606,70	LKCP016FSEFD	643,57
20	LKCP020FDED	427,71	LKCP020FSED	455,10	LKCP020FDEFD	606,70	LKCP020FSEFD	643,57
25	LKCP025FDED	451,32	LKCP025FSED	478,73	LKCP025FDEFD	630,32	LKCP025FSEFD	667,18
32	LKCP032FDED	497,19	LKCP032FSED	524,57	LKCP032FDEFD	676,17	LKCP032FSEFD	713,03
40	LKCP040FDED	573,63	LKCP040FSED	654,24	LKCP040FDEFD	752,63	LKCP040FSEFD	842,70
50	LKCP050FDED	662,94	LKCP050FSED	782,03	LKCP050FDEFD	841,94	LKCP050FSEFD	970,50
63	LKCP063FDED	774,80	LKCP063FSED	893,93	LKCP063FDEFD	953,81	LKCP063FSEFD	1.082,37

Válvula de bola motorizada en C-PVC 3 vías DUAL BLOCK®. Actuación neumática

Estándar paso en L, paso en T opcional, al mismo precio. Disponemos de otras conexiones bajo pedido: bridas, encolar macho y roscar (GAS, NPT) Las válvulas neumáticas se configuran NC (normalmente cerrada) de serie. La configuración NA (normalmente abierta) se debe especificar en el pedido



LKDIC/CP

Encolar

ACTUACIÓN NEUMÁTICA POLIAMIDA

ACTUACIÓN NEUMÁTICA POLIAMIDA CON ELECTROVÁLVULA, FINALE DE CARRERA (ELECTROMECAÑICOS) Y REGULADORES DE ESCAPE

d	DOBLE EFECTO		SIMPLE EFECTO		DOBLE EFECTO		SIMPLE EFECTO	
	Ref.	€	Ref.	€	Ref.	€	Ref.	€
16	LKCP016EDEP	465,74	LKCP016ESEP	486,38	LKCP016EDEFPP	699,89	LKCP016ESEFP	720,53
20	LKCP020EDEP	465,74	LKCP020ESEP	486,38	LKCP020EDEFPP	699,89	LKCP020ESEFP	720,53
25	LKCP025EDEP	525,03	LKCP025ESEP	545,67	LKCP025EDEFPP	759,16	LKCP025ESEFP	779,81
32	LKCP032EDEP	566,44	LKCP032ESEP	679,95	LKCP032EDEFPP	800,58	LKCP032ESEFP	914,10
40	LKCP040EDEP	645,97	LKCP040ESEP	867,84	LKCP040EDEFPP	880,11	LKCP040ESEFP	1.101,99
50	LKCP050EDEP	763,78	LKCP050ESEP	900,50	LKCP050EDEFPP	997,92	LKCP050ESEFP	1.134,65
63	LKCP063EDEP	929,08	LKCP063ESEP	988,43	LKCP063EDEFPP	1.163,21	LKCP063ESEFP	1.222,57
16	LKCP016FDEP	479,58	LKCP016FSEP	500,23	LKCP016FDEFPP	713,73	LKCP016FSEFP	734,37
20	LKCP020FDEP	479,58	LKCP020FSEP	500,23	LKCP020FDEFPP	713,73	LKCP020FSEFP	734,37
25	LKCP025FDEP	543,52	LKCP025FSEP	564,18	LKCP025FDEFPP	777,69	LKCP025FSEFP	798,34
32	LKCP032FDEP	589,37	LKCP032FSEP	702,90	LKCP032FDEFPP	823,52	LKCP032FSEFP	937,05
40	LKCP040FDEP	679,15	LKCP040FSEP	901,02	LKCP040FDEFPP	913,29	LKCP040FSEFP	1.135,17
50	LKCP050FDEP	819,48	LKCP050FSEP	956,22	LKCP050FDEFPP	1.053,64	LKCP050FSEFP	1.190,35
63	LKCP063FDEP	999,30	LKCP063FSEP	1.058,65	LKCP063FDEFPP	1.233,46	LKCP063FSEFP	1.292,79

Válvula de bola motorizada en C-PVC 3 vías DUAL BLOCK®. Actuación neumática

Estándar paso en L, paso en T opcional, al mismo precio. Disponemos de otras conexiones bajo pedido: bridas, encolar macho y roscar (GAS, NPT). Las válvulas neumáticas se configuran NC (normalmente cerrada) de serie. La configuración NA (normalmente abierta) se debe especificar en el pedido.

FKOC/CE

ACTUACIÓN ELÉCTRICA

ACTUACIÓN ELÉCTRICA CON BLOQUE DE SEGURIDAD

d	24-240 V AC/DC		24-240 V AC/DC		24-240 V AC/DC		24-240 V AC/DC	
	Ref.	€ EPDM	Ref.	€ FKM	Ref.	€ EPDM	Ref.	€ FKM
50	FKCE050E2D	793,51	FKCE050F2D	940,02	FKCE050E2BD	1.288,41	FKCE050F2BD	1.434,89
63	FKCE063E2D	811,41	FKCE063F2D	966,44	FKCE063E2BD	1.306,28	FKCE063F2BD	1.461,32
75	FKCE075E2D	1.078,78	FKCE075F2D	1.251,13	FKCE075E2BD	1.573,67	FKCE075F2BD	1.746,03
90	FKCE090E2D	1.109,93	FKCE090F2D	1.289,93	FKCE090E2BD	1.604,79	FKCE090F2BD	1.784,80
110	FKCE110E2D	1.143,55	FKCE110F2D	1.330,10	FKCE110E2BD	1.638,41	FKCE110F2BD	1.824,97
125	FKCE140E2D	1.608,62	FKCE140F2D	1.862,50	FKCE140E2BD	2.103,48	FKCE140F2BD	2.357,36
140	FKCE140E2D	1.608,62	FKCE140F2D	1.862,50	FKCE140E2BD	2.103,48	FKCE140F2BD	2.357,36
160	FKCE160E2D	1.882,73	FKCE160F2D	2.135,38	FKCE160E2BD	2.461,85	FKCE160F2BD	2.714,48
200-225	FKCE225E2D	2.193,76	FKCE225F2D	2.522,77	FKCE225E2BD	2.772,86	FKCE225F2BD	3.101,88
250	FKCE280E2D	4.013,26	FKCE280F2D	5.523,95	FKCE280E2BD	4.592,38	FKCE280F2BD	6.103,06
280	FKCE280E2D	4.013,26	FKCE280F2D	5.523,95	FKCE280E2BD	4.592,38	FKCE280F2BD	6.103,06
315	FKCE315E2D	4.243,94	FKCE315F2D	5.891,96	FKCE315E2BD	4.823,04	FKCE315F2BD	6.471,07

Válvula de mariposa industrial motorizada cuerpo en PPGR y disco en C-PVC. Actuación eléctrica.

Bajo pedido podemos suministrar otros actuadores: VALPES, BELIMO...
Bajo pedido también disponibles en 12V AC/DC



K

FKOC/CP

ACTUACIÓN NEUMÁTICA ALUMINIO

ACTUACIÓN NEUMÁTICA ALUMINIO CON ELECTROVÁLVULA, FINALES DE CARRERA (ELECTROMECÁNICOS) Y REGULADORES DE ESCAPE

d	DOBLE EFECTO		SIMPLE EFECTO		DOBLE EFECTO		SIMPLE EFECTO	
	Ref.	€	Ref.	€	Ref.	€	Ref.	€
50	FKCP050EDED	492,22	FKCP050ESED	572,82	FKCP050EDEFD	671,21	FKCP050ESEFD	761,27
63	FKCP063EDED	510,11	FKCP063ESED	590,71	FKCP063EDEFD	689,10	FKCP063ESEFD	779,17
75	FKCP075EDED	577,74	FKCP075ESED	696,82	FKCP075EDEFD	756,72	FKCP075ESEFD	885,27
90	FKCP090EDED	664,66	FKCP090ESED	771,50	FKCP090EDEFD	843,66	FKCP090ESEFD	959,96
110	FKCP110EDED	698,30	FKCP110ESED	1.100,46	FKCP110EDEFD	877,31	FKCP110ESEFD	1.288,92
125	FKCP140EDED	866,14	FKCP140ESED	1.470,52	FKCP140EDEFD	1.045,15	FKCP140ESEFD	1.658,97
140	FKCP140EDED	866,14	FKCP140ESED	1.470,52	FKCP140EDEFD	1.045,15	FKCP140ESEFD	1.658,97
160	FKCP160EDED	924,42	FKCP160ESED	1.528,77	FKCP160EDEFD	1.103,41	FKCP160ESEFD	1.717,22
200 - 225	FKCP225EDED	1.359,40	FKCP225ESED	2.188,86	FKCP225EDEFD	1.538,37	FKCP225ESEFD	2.377,29
250	FKCP280EDED	3.340,30	FKCP280ESED	5.098,78	FKCP280EDEFD	3.519,31	FKCP280ESEFD	5.287,23
280	FKCP280EDED	3.340,30	FKCP280ESED	5.098,78	FKCP280EDEFD	3.519,31	FKCP280ESEFD	5.287,23
315	FKCP315EDED	3.810,14	FKCP315ESED	6.237,90	FKCP315EDEFD	3.989,14	FKCP315ESEFD	6.426,33

50	FKCP050FDED	638,70	FKCP050FSED	719,30	FKCP050FDEFD	817,71	FKCP050FSEFD	907,76
63	FKCP063FDED	665,12	FKCP063FSED	745,74	FKCP063FDEFD	844,12	FKCP063FSEFD	934,18
75	FKCP075FDED	750,08	FKCP075FSED	869,16	FKCP075FDEFD	929,08	FKCP075FSEFD	1.057,63
90	FKCP090FDED	844,68	FKCP090FSED	951,51	FKCP090FDEFD	1.023,68	FKCP090FSEFD	1.139,96
110	FKCP110FDED	884,85	FKCP110FSED	1.287,03	FKCP110FDEFD	1.063,85	FKCP110FSEFD	1.475,47
125	FKCP140FDED	1.120,04	FKCP140FSED	1.724,39	FKCP140FDEFD	1.299,03	FKCP140FSEFD	1.912,84
140	FKCP140FDED	1.120,04	FKCP140FSED	1.724,39	FKCP140FDEFD	1.299,03	FKCP140FSEFD	1.912,84
160*	FKCP160FDED	1.177,07	FKCP160FSED	1.781,43	FKCP160FDEFD	1.356,08	FKCP160FSEFD	1.969,89
200 - 225	FKCP225FDED	1.688,41	FKCP225FSED	2.517,85	FKCP225FDEFD	1.867,41	FKCP225FSEFD	2.706,31
250	FKCP280FDED	4.850,99	FKCP280FSED	6.609,46	FKCP280FDEFD	5.029,99	FKCP280FSEFD	6.797,93
280	FKCP280FDED	4.850,99	FKCP280FSED	6.609,46	FKCP280FDEFD	5.029,99	FKCP280FSEFD	6.797,93
315	FKCP315FDED	5.458,15	FKCP315FSED	7.885,91	FKCP315FDEFD	5.637,16	FKCP315FSEFD	8.074,37

Válvula de mariposa industrial motorizada cuerpo en PPGR y disco en C-PVC. Actuación neumática.

Las válvulas neumáticas se configuran NC (normalmente cerrada) de serie. La configuración NA (normalmente abierta) se debe especificar en el pedido



FKOC/CP

K

ACTUACIÓN NEUMÁTICA POLIAMIDA

ACTUACIÓN NEUMÁTICA POLIAMIDA CON ELECTROVÁLVULA, FINALES DE CARRERA (ELECTROMECAÑICOS) Y REGULADORES DE ESCAPE

d	DOBLE EFECTO		SIMPLE EFECTO		DOBLE EFECTO		SIMPLE EFECTO	
	Ref.	€	Ref.	€	Ref.	€	Ref.	€
50	FKCP050EDEP	587,65	FKCP050ESEP	733,21	FKCP050EDEFPP	821,78	FKCP050ESEFP	967,36
63	FKCP063EDEP	605,52	FKCP063ESEP	751,10	FKCP063EDEFPP	839,68	FKCP063ESEFP	985,24
75	FKCP075EDEP	641,26	FKCP075ESEP	786,83	FKCP075EDEFPP	875,42	FKCP075ESEFP	1.020,98
90	FKCP090EDEP	758,30	FKCP090ESEP	817,66	FKCP090EDEFPP	992,46	FKCP090ESEFP	1.051,79
110	FKCP110EDEP	791,94	FKCP110ESEP	1.025,46	FKCP110EDEFPP	1.026,09	FKCP110ESEFP	1.259,61
125	FKCP140EDEP	922,94	FKCP140ESEP	1.424,25	FKCP140EDEFPP	1.157,09	FKCP140ESEFP	1.658,39
140	FKCP140EDEP	922,94	FKCP140ESEP	1.424,25	FKCP140EDEFPP	1.157,09	FKCP140ESEFP	1.658,39
160	FKCP160EDEP	1.145,02	FKCP160ESEP	1.482,53	FKCP160EDEFPP	1.379,16	FKCP160ESEFP	1.716,68
200	FKCP225EDEP	1.342,79	FKCP225ESEP	2.039,29	FKCP225EDEFPP	1.576,94	FKCP225ESEFP	2.273,43
225	FKCP225EDEP	1.342,79	FKCP225ESEP	2.039,29	FKCP225EDEFPP	1.576,94	FKCP225ESEFP	2.273,43
250*	FKCP280EDEP	3.499,73	FKCP280ESEP	4.992,83	FKCP280EDEFPP	3.733,87	FKCP280ESEFP	5.226,98
280*	FKCP280EDEP	3.499,73	FKCP280ESEP	4.992,83	FKCP280EDEFPP	3.733,87	FKCP280ESEFP	5.226,98
315*	FKCP315EDEP	3.730,42	FKCP315ESEP	5.223,52	FKCP315EDEFPP	3.964,56	FKCP315ESEFP	5.457,64

50	FKCP050FDEP	734,13	FKCP050FSEP	879,69	FKCP050FDEFPP	968,28	FKCP050FSEFP	1.113,84
63	FKCP063FDEP	760,56	FKCP063FSEP	906,13	FKCP063FDEFPP	994,70	FKCP063FSEFP	1.140,27
75	FKCP075FDEP	813,62	FKCP075FSEP	959,18	FKCP075FDEFPP	1.047,75	FKCP075FSEFP	1.193,34
90	FKCP090FDEP	938,33	FKCP090FSEP	997,67	FKCP090FDEFPP	1.172,48	FKCP090FSEFP	1.231,82
110	FKCP110FDEP	978,50	FKCP110FSEP	1.212,04	FKCP110FDEFPP	1.212,65	FKCP110FSEFP	1.446,21
125	FKCP140FDEP	1.176,82	FKCP140FSEP	1.678,13	FKCP140FDEFPP	1.410,97	FKCP140FSEFP	1.912,27
140	FKCP140FDEP	1.176,82	FKCP140FSEP	1.678,13	FKCP140FDEFPP	1.410,97	FKCP140FSEFP	1.912,27
160	FKCP160FDEP	1.397,66	FKCP160FSEP	1.735,17	FKCP160FDEFPP	1.631,82	FKCP160FSEFP	1.969,30
200	FKCP225FDEP	1.671,79	FKCP225FSEP	2.368,30	FKCP225FDEFPP	1.905,93	FKCP225FSEFP	2.602,45
225	FKCP225FDEP	1.671,79	FKCP225FSEP	2.368,30	FKCP225FDEFPP	1.905,93	FKCP225FSEFP	2.602,45
250*	FKCP280FDEP	5.010,40	FKCP280FSEP	6.503,52	FKCP280FDEFPP	5.244,54	FKCP280FSEFP	6.737,66
280*	FKCP280FDEP	5.010,40	FKCP280FSEP	6.503,52	FKCP280FDEFPP	5.244,54	FKCP280FSEFP	6.737,66
315*	FKCP315FDEP	5.378,43	FKCP315FSEP	6.871,53	FKCP315FDEFPP	5.612,58	FKCP315FSEFP	7.105,69

Válvula de mariposa industrial motorizada
 cuerpo en PPGR y disco en C-PVC.
 Actuación neumática

Las válvulas neumáticas se configuran NC (normalmente cerrada) de serie.
 La configuración NA (normalmente abierta) se debe especificar en el pedido
 * Actuadores de aluminio



Sistema C-PVC

Válvulas de membrana actuadas



DK/CP NC

VM/CP NC

d	Modelo	DN	Ref. EPDM	€ EPDM	Ref. FKM	€ FKM	Ref. PTFE	L € PTFE
20	DKDC/CP NC	15	DKDCNC020E	240,58	DKDCNC020F	303,18	DKDCNC020P	312,23
25	DKDC/CP NC	20	DKDCNC025E	251,76	DKDCNC025F	315,05	DKDCNC025P	324,45
32	DKDC/CP NC	25	DKDCNC032E	308,45	DKDCNC032F	384,72	DKDCNC032P	406,21
40	DKDC/CP NC	32	DKDCNC040E	404,84	DKDCNC040F	516,13	DKDCNC040P	539,20
50	DKDC/CP NC	40	DKDCNC050E	458,84	DKDCNC050F	582,03	DKDCNC050P	582,03
63	DKDC/CP NC	50	DKDCNC063E	633,24	DKDCNC063F	831,39	DKDCNC063P	813,79
75	DKDC/CP NC	65	DKDCNC075E	759,87	DKDCNC075F	997,66	DKDCNC075P	976,57
90	VMDC/CP NC	80	VMDNCNC090E	1.148,77	VMDNCNC090F	1.529,96	VMDNCNC090P	1.328,42
110	VMDC/CP NC	100	VMDNCNC110E	1.394,46	VMDNCNC110F	1.769,04	VMDNCNC110P	1.570,89

Válvula neumática **NORMALMENTE CERRADA.**

M-M encolar.



DK/CP NO

VM/CP NO

d	Modelo	DN	Ref. EPDM	€ EPDM	Ref. FKM	€ FKM	Ref. PTFE	L € PTFE
20	DKDC/CP NO	15	DKDCNO020E	216,84	DKDCNO020F	283,67	DKDCNO020P	304,00
25	DKDC/CP NO	20	DKDCNO025E	228,77	DKDCNO025F	296,35	DKDCNO025P	317,43
32	DKDC/CP NO	25	DKDCNO032E	270,59	DKDCNO032F	310,76	DKDCNO032P	339,76
40	DKDC/CP NO	32	DKDCNO040E	291,58	DKDCNO040F	428,31	DKDCNO040P	460,44
50	DKDC/CP NO	40	DKDCNO050E	339,88	DKDCNO050F	487,76	DKDCNO050P	487,76
63	DKDC/CP NO	50	DKDCNO063E	432,77	DKDCNO063F	671,14	DKDCNO063P	671,14
75	DKDC/CP NO	65	DKDCNO075E	519,31	DKDCNO075F	805,37	DKDCNO075P	805,37
90	VMDC/CP NO	80	VMDCNO090E	810,53	VMDCNO090F	1.282,05	VMDCNO090P	1.159,81
110	VMDC/CP NO	100	VMDCNO110E	1.231,08	VMDCNO110F	1.482,39	VMDCNO110P	1.294,06

Válvula neumática **NORMALMENTE ABIERTA.**

M-M encolar.



DK/CP DE

VM/CP DE

d	Modelo	DN	Ref. EPDM	€ EPDM	Ref. FKM	€ FKM	Ref. PTFE	L € PTFE
20	DKDC/CP DE	15	DKDCDA020E	165,45	DKDCDA020F	228,05	DKDCDA020P	240,80
25	DKDC/CP DE	20	DKDCDA025E	176,61	DKDCDA025F	239,91	DKDCDA025P	252,95
32	DKDC/CP DE	25	DKDCDA032E	238,57	DKDCDA032F	282,52	DKDCDA032P	308,89
40	DKDC/CP DE	32	DKDCDA040E	265,10	DKDCDA040F	389,36	DKDCDA040P	418,56
50	DKDC/CP DE	40	DKDCDA050E	308,98	DKDCDA050F	443,42	DKDCDA050P	443,42
63	DKDC/CP DE	50	DKDCDA063E	393,42	DKDCDA063F	610,14	DKDCDA063P	610,14
75	DKDC/CP DE	65	DKDCDA075E	472,10	DKDCDA075F	732,15	DKDCDA075P	732,15
90	VMDC/CP DE	80	VMDCDA090E	983,48	VMDCDA090F	1.455,00	VMDCDA090P	1.332,76
110	VMDC/CP DE	100	VMDCDA110E	1.309,85	VMDCDA110F	1.682,37	VMDCDA110P	1.487,04

Válvula neumática **DOBLE EFECTO**

M-M encolar.



DK/CP NC

d	Modelo	DN	Ref. EPDM	€ EPDM	Ref. FKM	€ FKM	Ref. PTFE	L € PTFE
20	DKUIC/CP NC	15	DKUICNC020E	249,52	DKUICNC020F	312,10	DKUICNC020P	325,13
25	DKUIC/CP NC	20	DKUICNC025E	261,45	DKUICNC025F	324,77	DKUICNC025P	345,62
32	DKUIC/CP NC	25	DKUICNC032E	321,61	DKUICNC032F	396,96	DKUICNC032P	423,06
40	DKUIC/CP NC	32	DKUICNC040E	425,00	DKUICNC040F	536,30	DKUICNC040P	563,01
50	DKUIC/CP NC	40	DKUICNC050E	481,56	DKUICNC050F	604,80	DKUICNC050P	604,80
63	DKUIC/CP NC	50	DKUICNC063E	669,30	DKUICNC063F	867,40	DKUICNC063P	867,40

Válvula neumática **NORMALMENTE CERRADA.**

Con enlaces H-H encolar.



DK/CP NO

d	Modelo	DN	Ref. EPDM	€ EPDM	Ref. FKM	€ FKM	Ref. PTFE	L € PTFE
20	DKUIC/CP NO	15	DKUICNO020E	226,38	DKUICNO020F	293,21	DKUICNO020P	318,31
25	DKUIC/CP NO	20	DKUICNO025E	239,11	DKUICNO025F	306,72	DKUICNO025P	341,10
32	DKUIC/CP NO	25	DKUICNO032E	288,41	DKUICNO032F	326,58	DKUICNO032P	362,42
40	DKUIC/CP NO	32	DKUICNO040E	317,53	DKUICNO040F	454,29	DKUICNO040P	490,73
50	DKUIC/CP NO	40	DKUICNO050E	370,44	DKUICNO050F	517,13	DKUICNO050P	517,13
63	DKUIC/CP NO	50	DKUICNO063E	478,00	DKUICNO063F	717,57	DKUICNO063P	717,57

Válvula neumática **NORMALMENTE ABIERTA.**

Con enlaces H-H encolar.



DK/CP DE

d	Modelo	DN	Ref. EPDM	€ EPDM	Ref. FKM	€ FKM	Ref. PTFE	L € PTFE
20	DKUIC/CP DE	15	DKUICDA020E	174,37	DKUICDA020F	236,96	DKUICDA020P	253,86
25	DKUIC/CP DE	20	DKUICDA025E	186,31	DKUICDA025F	249,62	DKUICDA025P	274,92
32	DKUIC/CP DE	25	DKUICDA032E	255,21	DKUICDA032F	349,02	DKUICDA032P	329,48
40	DKUIC/CP DE	32	DKUICDA040E	288,67	DKUICDA040F	413,00	DKUICDA040P	446,15
50	DKUIC/CP DE	40	DKUICDA050E	336,76	DKUICDA050F	470,11	DKUICDA050P	470,11
63	DKUIC/CP DE	50	DKUICDA063E	434,55	DKUICDA063F	652,35	DKUICDA063P	652,35

Válvula neumática **DOBLE EFECTO.**

Con enlaces H-H encolar.



DK/CP NC

Rh	Modelo	DN	Ref. EPDM	€ EPDM	Ref. FKM	€ FKM	Ref. PTFE	L € PTFE
1/2"	DKUFC/CP NC	15	DKUFCNC012E	274,48	DKUFCNC012F	308,98	DKUFCNC012P	343,32
3/4"	DKUFC/CP NC	20	DKUFCNC034E	287,59	DKUFCNC034F	321,51	DKUFCNC034P	357,22
1"	DKUFC/CP NC	25	DKUFCNC100E	353,76	DKUFCNC100F	436,67	DKUFCNC100P	465,38
1 1/4"	DKUFC/CP NC	32	DKUFCNC114E	467,49	DKUFCNC114F	589,93	DKUFCNC114P	619,32
1 1/2"	DKUFC/CP NC	40	DKUFCNC112E	529,72	DKUFCNC112F	665,29	DKUFCNC112P	665,29
2"	DKUFC/CP NC	50	DKUFCNC200E	736,21	DKUFCNC200F	1.074,50	DKUFCNC200P	954,14

Válvula neumática **NORMALMENTE CERRADA.**

Con enlaces H-H roscar.



DK/CP NO

Rh	Modelo	DN	Ref. EPDM	€ EPDM	Ref. FKM	€ FKM	Ref. PTFE	L € PTFE
1/2"	DKUFC/CP NO	15	DKUFCNO012E	253,02	DKUFCNO012F	289,88	DKUFCNO012P	326,53
3/4"	DKUFC/CP NO	20	DKUFCNO034E	267,01	DKUFCNO034F	303,25	DKUFCNO034P	341,40
1"	DKUFC/CP NO	25	DKUFCNO100E	317,35	DKUFCNO100F	359,24	DKUFCNO100P	398,67
1 1/4"	DKUFC/CP NO	32	DKUFCNO114E	349,28	DKUFCNO114F	499,73	DKUFCNO114P	539,82
1 1/2"	DKUFC/CP NO	40	DKUFCNO112E	407,48	DKUFCNO112F	568,84	DKUFCNO112P	568,84
2"	DKUFC/CP NO	50	DKUFCNO200E	525,81	DKUFCNO200F	789,34	DKUFCNO200P	789,34

Válvula neumática **NORMALMENTE ABIERTA.**

Con enlaces H-H roscar.



DK/CP DE

Rh	Modelo	DN	Ref. EPDM	€ EPDM	Ref. FKM	€ FKM	Ref. PTFE	L € PTFE
1/2"	DKUFC/CP DE	15	DKUFCDA012E	199,35	DKUFCDA012F	233,83	DKUFCDA012P	268,17
3/4"	DKUFC/CP DE	20	DKUFCDA034E	212,45	DKUFCDA034F	246,37	DKUFCDA034P	282,10
1"	DKUFC/CP DE	25	DKUFCDA100E	282,70	DKUFCDA100F	326,58	DKUFCDA100P	385,92
1 1/4"	DKUFC/CP DE	32	DKUFCDA114E	317,53	DKUFCDA114F	454,29	DKUFCDA114P	490,75
1 1/2"	DKUFC/CP DE	40	DKUFCDA112E	370,44	DKUFCDA112F	517,12	DKUFCDA112P	517,12
2"	DKUFC/CP DE	50	DKUFCDA200E	478,00	DKUFCDA200F	717,57	DKUFCDA200P	717,57

Válvula neumática **DOBLE EFECTO.**

Con enlaces H-H roscar.



DK/CP NC



VM/CP NC

d	Modelo	DN	Ref. EPDM	€ EPDM	Ref. FKM	€ FKM	Ref. PTFE	L € PTFE
20	DKOC/CP NC	15	DKOCNC020E	288,69	DKOCNC020F	351,27	DKOCNC020P	359,40
25	DKOC/CP NC	20	DKOCNC025E	302,11	DKOCNC025F	365,41	DKOCNC025P	373,93
32	DKOC/CP NC	25	DKOCNC032E	370,14	DKOCNC032F	446,40	DKOCNC032P	468,46
40	DKOC/CP NC	32	DKOCNC040E	485,79	DKOCNC040F	597,09	DKOCNC040P	620,83
50	DKOC/CP NC	40	DKOCNC050E	550,61	DKOCNC050F	673,82	DKOCNC050P	673,82
63	DKOC/CP NC	50	DKOCNC063E	759,91	DKOCNC063F	958,06	DKOCNC063P	940,41
75	DKOC/CP NC	65	DKOCNC075E	911,89	DKOCNC075F	1.149,66	DKOCNC075P	1.128,48
90	VMOC/CP NC	80	VMOCNC090E	1.321,10	VMOCNC090F	1.702,29	VMOCNC090P	1.500,76
110	VMOC/CP NC	100	VMOCNC110E	1.603,67	VMOCNC110F	1.977,80	VMOCNC110P	1.779,98

Válvula neumática **NORMALMENTE CERRADA.**
Con bridas DIN.

Disponibles con bridas ANSI 150 libras al mismo precio



DK/CP NO



VM/CP NO

d	Modelo	DN	Ref. EPDM	€ EPDM	Ref. FKM	€ FKM	Ref. PTFE	L € PTFE
20	DKOC/CP NO	15	DKOCNO020E	268,21	DKOCNO020F	335,03	DKOCNO020P	355,90
25	DKOC/CP NO	20	DKOCNO025E	282,55	DKOCNO025F	350,14	DKOCNO025P	371,83
32	DKOC/CP NO	25	DKOCNO032E	291,03	DKOCNO032F	378,63	DKOCNO032P	408,24
40	DKOC/CP NO	32	DKOCNO040E	340,31	DKOCNO040F	517,33	DKOCNO040P	550,28
50	DKOC/CP NO	40	DKOCNO050E	440,81	DKOCNO050F	588,72	DKOCNO050P	588,72
63	DKOC/CP NO	50	DKOCNO063E	572,07	DKOCNO063F	810,46	DKOCNO063P	810,46
75	DKOC/CP NO	65	DKOCNO075E	686,47	DKOCNO075F	972,54	DKOCNO075P	972,54
90	VMOC/CP NO	80	VMOCNO090E	982,85	VMOCNO090F	1.454,36	VMOCNO090P	1.332,13
110	VMOC/CP NO	100	VMOCNO110E	1.392,68	VMOCNO110F	1.689,77	VMOCNO110P	1.450,25

Válvula neumática **NORMALMENTE ABIERTA.**
Con bridas DIN.

Disponibles con bridas ANSI 150 libras al mismo precio



DK/CP DE



VM/CP DE

d	Modelo	DN	Ref. EPDM	€ EPDM	Ref. FKM	€ FKM	Ref. PTFE	L € PTFE
20	DKOC/CP DE	15	DKOCDA020E	213,56	DKOCDA020F	276,12	DKOCDA020P	287,95
25	DKOC/CP DE	20	DKOCDA025E	226,97	DKOCDA025F	290,27	DKOCDA025P	302,37
32	DKOC/CP DE	25	DKOCDA032E	304,21	DKOCDA032F	344,22	DKOCDA032P	371,12
40	DKOC/CP DE	32	DKOCDA040E	346,02	DKOCDA040F	470,30	DKOCDA040P	500,25
50	DKOC/CP DE	40	DKOCDA050E	400,75	DKOCDA050F	535,21	DKOCDA050P	535,21
63	DKOC/CP DE	50	DKOCDA063E	520,05	DKOCDA063F	736,78	DKOCDA063P	736,78
75	DKOC/CP DE	65	DKOCDA075E	624,06	DKOCDA075F	884,14	DKOCDA075P	884,14
90	VMOC/CP DE	80	VMOCD A090E	1.155,79	VMOCD A090F	1.627,34	VMOCD A090P	1.505,08
110	VMOC/CP DE	100	VMOCD A110E	1.461,35	VMOCD A110F	1.890,73	VMOCD A110P	1.638,54

Válvula neumática **DOBLE EFECTO.**
Con bridas DIN.

Disponibles con bridas ANSI 150 libras al mismo precio

CMDC/CP NC

M-M encolar



CMUIC/CP NC

H-H enlaces encolar

d	Ref. EPDM	DN	L		
			€ EPDM	€ FKM	€ PTFE
20	CMDCNC020E	15	151,60	164,72	177,89
20	CMUICNC020E	15	181,40	198,03	212,95 (A)

Válvula de membrana compacta neumática
NORMALMENTE CERRADA.

Código en FKM termina en "F" en lugar de "E"
 Código en PTFE termina en "P" en lugar de "E"
 (A) Juntas en FKM

CMDC/CP NO

M-M encolar



CMUIC/CP NO

H-H enlaces encolar

d	Ref. EPDM	DN	L		
			€ EPDM	€ FKM	€ PTFE
20	CMDCNO020E	15	148,95	162,98	174,36
20	CMUICNO020E	15	178,76	196,28	211,20 (A)

Válvula de membrana compacta neumática
NORMALMENTE ABIERTA.

Código en FKM termina en "F" en lugar de "E"
 Código en PTFE termina en "P" en lugar de "E"
 (A) Juntas en FKM

CMDC/CP DE

M-M encolar



CMUIC/CP DE

H-H enlaces encolar

d	Ref. EPDM	DN	L		
			€ EPDM	€ FKM	€ PTFE
20	CMDCDA020E	15	148,95	162,98	174,36
20	CMUICDA020E	15	178,76	196,28	211,20 (A)

Válvula de membrana compacta neumática
DOBLE EFECTO.

Código en FKM termina en "F" en lugar de "E"
 Código en PTFE termina en "P" en lugar de "E"
 (A) Juntas en FKM

**DKBDC/CP NC**

d	Ref. EPDM	DN	PN	L € EPDM
20	DKBDCNC020E	15	6	223,92
25	DKBDCNC025E	20	6	235,09
32	DKBDCNC032E	25	6	292,44
40	DKBDCNC040E	32	6	364,77
50	DKBDCNC050E	40	6	379,26
63	DKBDCNC063E	50	6	531,28
75	DKBDCNC075E	65	6	626,26

Válvula de membrana neumática
Normalmente Cerrada.

M-M encolar

Actuador a pistón

DKBUIC/CP NC

d	Ref. EPDM	DN	PN	L € EPDM
20	DKBUICNC020E	15	6	546,32
25	DKBUICNC025E	20	6	371,03
32	DKBUICNC032E	25	6	393,37
40	DKBUICNC040E	32	6	224,76
50	DKBUICNC050E	40	6	237,48
63	DKBUICNC063E	50	6	298,17

Válvula de membrana neumática
Normalmente Cerrada.

Con enlaces H-H encolar

Actuador a pistón

**DKBUFC/CP NC**

Rh	Ref. EPDM	DN	PN	L € EPDM
½"	DKBUFCNC012E	15	6	224,76
¾"	DKBUFCNC034E	20	6	237,48
1"	DKBUFCNC100E	25	6	298,17
1 ¼"	DKBUFCNC114E	32	6	371,03
1 ½"	DKBUFCNC112E	40	6	393,37
2"	DKBUFCNC200E	50	6	546,32

Válvula de membrana neumática
Normalmente Cerrada.

Con enlaces H-H para roscar

Actuador a pistón

DKBOC/CP NC

d	Ref. EPDM	DN	PN	L € EPDM
20	DKBOCNC020E	15	6	257,50
25	DKBOCNC025E	20	6	270,33
32	DKBOCNC032E	25	6	342,65
40	DKBOCNC040E	32	6	431,07
50	DKBOCNC050E	40	6	448,18
63	DKBOCNC063E	50	6	627,88
75	DKBOCNC075E	65	6	801,79

Válvula de membrana neumática
Normalmente Cerrada.

Con bridas DIN

Actuador a pistón

**DKBOAC/CP NC**

d	Ref. EPDM	DN	PN	L € EPDM
½"	DKBOACNC012E	15	6	257,50
¾"	DKBOACNC034E	20	6	270,33
1"	DKBOACNC100E	25	6	342,65
1 ¼"	DKBOACNC114E	32	6	431,07
1 ½"	DKBOACNC112E	40	6	448,18
2"	DKBOACNC200E	50	6	627,88
2 ½"	DKBOACNC212E	65	6	801,79

Válvula de membrana neumática
Normalmente Cerrada.

Con bridas ANSI 150 lbs

Actuador a pistón



MANGUITO

C1

d	Ref.	Para válvulas	€
16	ENDIC016	VKD-TKD-VXE-SXE-RV	16,01
20	ENDIC020	VKD-TKD-VXE-SXE-RV	16,01
25	ENDIC025	VKD-TKD-VXE-SXE-RV	27,18
32	ENDIC032	VKD-TKD-VXE-SXE-RV	28,78
40	ENDIC040	VKD-TKD-VXE-SXE-RV	31,99
50	ENDIC050	VKD-TKD-VXE-SXE-RV	35,18
63	ENDIC063	VKD-TKD-VXE-SXE-RV	40,00
75	ENDIC075	VKD-VXE-SSE	47,98
90	ENDIC090	VKD	70,39
90	ENDIC090VXE	VXE-SXE	70,39
110	ENDIC110	VKD	87,97
110	ENDIC110VXE	VXE-SXE	87,97

Conector final en C-PVC.
H encolar.



MANGUITO

C1

Rh	Ref.	Para válvulas	€
3/8"	ENDFC038	VKD-TKD-VXE-SXE-RV	16,01
1/2"	ENDFC012	VKD-TKD-VXE-SXE-RV	16,01
3/4"	ENDFC034	VKD-TKD-VXE-SXE-RV	27,18
1"	ENDFC100	VKD-TKD-VXE-SXE-RV	28,78
1 1/4"	ENDFC114	VKD-TKD-VXE-SXE-RV	31,99
1 1/2"	ENDFC112	VKD-TKD-VXE-SXE-RV	35,18
2"	ENDFC200	VKD	40,00
2 1/2"	ENDFC212	VKD	47,98
3"	ENDFC300	VKD	70,39
3"	ENDFC300VXE	VXE-SXE	70,39
4"	ENDFC400	VKD	87,97
4"	ENDFC400VXE	VXE-SXE	87,97

Conector final en C-PVC.
H rosca GAS.



MANGUITO

C1

d	Ref.	Para válvulas	€
1/2"	ENDAC012	VKD-TKD-VXE-SXE-RV	16,01
3/4"	ENDAC034	VKD-TKD-VXE-SXE-RV	27,18
1"	ENDAC100	VKD-TKD-VXE-SXE-RV	28,78
1 1/4"	ENDAC114	VKD-TKD-VXE-SXE-RV	31,99
1 1/2"	ENDAC112	VKD-TKD-VXE-SXE-RV	35,18
2"	ENDAC200	VKD-TKD-VXE-SXE-RV	40,00
2 1/2"	ENDAC212	VKD	47,98
3"	ENDAC300	VKD	70,39
3"	ENDAC300VXE	VKD	70,39
4"	ENDAC400	VXE-SXE	87,97
4"	ENDAC400VXE	VKD	87,97

Conector final en C-PVC.
H encolar serie ASTM.



MANGUITO

C1

d	Ref.	Para válvulas	€
16	ENDDC016	VKD-TKD-VXE-SXE-RV	16,01
20	ENDDC020	VKD-TKD-VXE-SXE-RV	16,01
25	ENDDC025	VKD-TKD-VXE-SXE-RV	27,18
32	ENDDC032	VKD-TKD-VXE-SXE-RV	28,78
40	ENDDC040	VKD-TKD-VXE-SXE-RV	31,99
50	ENDDC050	VKD-TKD-VXE-SXE-RV	35,18
63	ENDDC063	VKD-TKD-VXE-SXE-RV	40,00
75	ENDDC075	VKD	47,98
90	ENDDC090	VKD	70,39
90	ENDDC090VXE	VXE-SSE	70,39
110	ENDDC110	VKD	87,97
110	ENDDC110VXE	VXE-SSE	87,97

Conector final en C-PVC.
M encolar.



MANGUITO

C1

Rh	Ref.	Para válvulas	€
1/2"	ENDNC012	VKD-TKD-VXE-SXE-RV	16,01
3/4"	ENDNC034	VKD-TKD-VXE-SXE-RV	27,18
1"	ENDNC100	VKD-TKD-VXE-SXE-RV	28,78
1 1/4"	ENDNC114	VKD-TKD-VXE-SXE-RV	31,99
1 1/2"	ENDNC112	VKD-TKD-VXE-SXE-RV	35,18
2"	ENDNC200	VKD-TKD-VXE-SXE-RV	40,00
2 1/2"	ENDNC212	VKD	47,98
3"	ENDNC300	VKD	70,39
3"	ENDNC300VXE	VXE-SXE	70,39
4"	ENDNC400	VKD	87,97
4"	ENDNC400VXE	VXE-SXE	87,97

Conector final en C-PVC.
H rosca NPT.

Tubo y accesorios
Válvulas manuales
Válvulas actuadas
Válvulas de presión

Sistema
ABS
INDUSTRIA



Sistema ABS





INDUSTRIA

Sistema ABS

Tubo y accesorios

Durapipe

**TUBO**

F1

d	Ref.	PN	Espesor	€/m.
16	PIPED10016	10	1,5	4,97
20	PIPED10020	10	1,6	5,05
25	PIPED10025	10	1,9	5,21
32	PIPED10032	10	2,1	5,94
40	PIPED10040	10	2,7	8,81
50	PIPED10050	10	3,4	15,39
63	PIPED10063	10	4,2	23,63
75	PIPED10075	10	5,0	28,58
90	PIPED10090	10	6,0	36,66
110	PIPED10110	10	7,3	51,30
125	PIPED10125	10	8,2	73,31
140	PIPED10140	10	9,3	106,32
160	PIPED10160	10	10,5	124,66
200	PIPED10200	10	13,2	175,98
225	PIPED10225	10	14,8	220,00
250	PIPED10250	10	16,1	231,85
315	PIPED10315	8	20,8	371,48

Tubo.

Barras de 5 m.

**GID**

F1

d	Ref.	PN	€
16	GID016	10	2,13
20	GID020	10	2,78
25	GID025	10	2,99
32	GID032	10	3,94
40	GID040	10	6,66
50	GID050	10	8,77
63	GID063	10	13,45
75	GID075	10	28,63
90	GID090	10	33,71
110	GID110	10	50,52
125	GID125	10	87,58
140	GID140	10	150,58
160	GID160	10	123,84
200	GID200	10	198,74
225	GID225	10	262,73
250	GID250	10	966,08
315	GID315	8	1.393,01

Codo 90°.

H-H encolar.

**HID**

F1

d	Ref.	PN	€
16	HID016	10	5,16
20	HID020	10	5,42
25	HID025	10	5,67
32	HID032	10	5,77
40	HID040	10	7,40
50	HID050	10	9,75
63	HID063	10	15,48
75	HID075	10	27,25
90	HID090	10	33,71
110	HID110	10	67,35
125	HID125	10	269,51
140	HID140	10	111,16
160	HID160	10	370,56
200	HID200	10	433,36
225	HID225	10	475,17
250	HID250	10	722,56
315	HID315	8	969,95

Codo 45°.

H-H encolar.

**TID**

F1

d	Ref.	PN	€
16	TID016	10	9,90
20	TID020	10	2,98
25	TID025	10	10,31
32	TID032	10	5,82
40	TID040	10	7,77
50	TID050	10	11,10
63	TID063	10	17,50
75	TID075	10	70,77
90	TID090	10	121,29
110	TID110	10	64,85
125	TID125	10	134,73
140	TID140	10	181,90
160	TID160	10	208,85
200	TID200	10	336,87
225	TID225	10	437,92
250	TID250	10	1.005,89
315	TID315	8	1.996,65

Te a 90°.

H-H-H encolar.



MID

F1

d	Ref.	PN	Espesor	€/m.
16	MID016	10	1,5	1,78
20	MID020	10	1,6	1,93
25	MID025	10	1,9	2,15
32	MID032	10	2,1	2,78
40	MID040	10	2,7	3,59
50	MID050	10	3,4	5,21
63	MID063	10	4,2	6,72
75	MID075	10	5,0	15,48
90	MID090	10	6,0	25,27
110	MID110	10	7,3	33,71
125	MID125	10	8,2	60,65
140	MID140	10	9,3	67,35
160	MID160	10	10,5	77,47
200	MID200	10	13,2	138,12
225	MID225	10	14,8	202,14
250	MID250	10	16,1	613,96
315	MID315	8	20,8	889,57

Manguito.
 H-H encolar.



QPD

F1

d	Ref.	PN	€
16	QPD016	10	2,73
20	QPD020	10	4,38
25	QPD025	10	2,93
32	QPD032	10	3,49
40	QPD040	10	6,25
50	QPD050	10	10,44
63	QPD063	10	14,82
75	QPD075	10	21,55
90	QPD090	10	29,66
110	QPD110	10	37,09
125	QPD125	10	77,47
140	QPD140	10	77,47
160	QPD160	10	101,07
200	QPD200	10	107,78
225	QPD225	10	208,85
250	QPD250	10	410,37
315	QPD315	8	505,62

Manguito portabridas.
 H encolar.



APL

F1

d x Rh	Ref.	€
16 x 3/8"	APL016038	39,04
20 x 1/2"	APL020012	41,91
25 x 1/2"	APL025012	69,03
25 x 3/4"	APL025034	68,83
3/4" x 1/2" (3 orificios)	APL034012	113,78

Aplique mural ABS-Latón.
 H-H encolar-rosca.



GFD

F1

Rh	Ref.	€
1/2"	GFD012	14,47
3/4"	GFD034	14,79
1"	GFD100	19,15
1 1/2"	GFD112	37,00
2"	GFD200	57,13

Codo 90° roscado.
 H-H rosca.



SMD

F1

d	Ref.	PN	€
125	SMD125	10	422,24
140	SMD140	10	530,90
160	SMD160	10	870,48

Curva 90°.
 M-M encolar.

d	Ref.	PN	€
200	SMD200	10	1.333,16
225	SMD225	10	1.687,11



TRID

F1

d x dr	Ref.	PN	€
25 x 20	TRID025020	10	10,10
32 x 20	TRID032020	10	13,82
32 x 25	TRID032025	10	15,48
40 x 20	TRID040020	10	14,37
40 x 25	TRID040025	10	21,55
50 x 20	TRID050020	10	18,47
50 x 25	TRID050025	10	18,47
50 x 32	TRID050032	10	18,47
63 x 25	TRID063025	10	14,97
63 x 32	TRID063032	10	14,97
75 x 32	TRID075032	10	35,01
75 x 50	TRID075050	10	54,72
110 x 50	TRID110050	10	112,82

Te a 90° reducida.

H-H-H encolar.



TSD

F1

d	Ref.	PN	€
32	TSD032	10	20,71
50	TSD050	10	32,27
63	TSD063	10	47,66
110	TSD110	10	95,71

Te a 90° suave.

H-H-H encolar.



AID

F1

d	Ref.	PN	€
16	AID016	10	3,77
20	AID020	10	4,86
25	AID025	10	5,82
32	AID032	10	6,72

Espiga.

M encolar.



CID

F1

d	Ref.	PN	€
16	CID016	10	1,61
20	CID020	10	1,66
25	CID025	10	2,08
32	CID032	10	2,43
40	CID040	10	3,59
50	CID050	10	14,49
63	CID063	10	7,77
75	CID075	10	18,51
90	CID090	10	21,22
110	CID110	10	31,65

Tapón.

H encolar.



YID

F1

d	Ref.	PN	€
20	YID020	10	16,17
25	YID025	10	17,19
32	YID032	10	19,57
40	YID040	10	23,57
50	YID050	10	29,66
63	YID063	10	43,79

Te a 45°.

H-H-H encolar.



SID

F1

d	Ref.	PN	€
20	SID020	10	9,75
25	SID025	10	10,44
32	SID032	10	14,14
40	SID040	10	20,54
50	SID050	10	27,95
63	SID063	10	33,36
75	SID075	10	70,77
90	SID090	10	70,77
110	SID110	10	128,00

Curva 90°.

H-H encolar.



BS

F1

d x di	Ref.	PN	€
20 x 1/2"	BS020012	10	2,84
25 x 3/4"	BS025034	10	3,50
32 x 1"	BS032100	10	5,11
40 x 1 1/4"	BS040114	10	5,26
50 x 1 1/2"	BS050112	10	5,82
63 x 2"	BS063200	10	8,83
90 x 3"	BS090300	10	25,69
110 x 4"	BS110400	10	37,09
160 x 6"	BS160600	10	87,58

Manguito transición métrico-imperial.
 H-H encolar.



MIFD

F1

dm x dh x Rh	Ref.	PN	€
16 x 12 x 3/8"	MIFD16012038	10	4,63
20 x 16 x 1/2"	MIFD20016012	10	5,21
25 x 20 x 3/4"	MIFD25020034	10	6,25
32 x 25 x 1"	MIFD32025100	10	7,77
40 x 32 x 1 1/4"	MIFD40032114	10	9,75
50 x 40 x 1 1/2"	MIFD50040112	10	15,84
63 x 50 x 2"	MIFD63050200	10	18,87

Doble adaptador mixto M/H-H.
 M-H encolar - H roscar



KIFD

F1

dm x dh x Rm	Ref.	PN	€
20 x 16 x 3/8"	KIFD20016038	10	2,85
20 x 16 x 1/2"	KIFD20016012	10	2,93
25 x 20 x 1/2"	KIFD25020012	10	3,12
25 x 20 x 3/4"	KIFD25020034	10	3,12
32 x 25 x 3/4"	KIFD32025034	10	3,59
32 x 25 x 1"	KIFD32025100	10	3,59
40 x 32 x 1"	KIFD40032100	10	5,04
40 x 32 x 1 1/4"	KIFD40032114	10	5,04
50 x 40 x 1 1/4"	KIFD50040114	10	7,77
50 x 40 x 1 1/2"	KIFD50040112	10	10,44
63 x 50 x 1 1/2"	KIFD63050112	10	30,00
63 x 50 x 2"	KIFD63050200	10	10,44
75 x 63 x 2"	KIFD75063200	10	15,48

Terminal rosca macho.
 M-H encolar - M roscar



DID

F1

dm x dh	Ref.	PN	€
20 x 16	DID020016	10	1,29
25 x 20	DID025020	10	1,93
32 x 16	DID032016	10	3,15
32 x 25	DID032025	10	2,78
40 x 32	DID040032	10	4,63
50 x 20	DID050020	10	5,11
50 x 25	DID050025	10	5,52
50 x 32	DID050032	10	6,19
50 x 40	DID050040	10	9,76
63 x 25	DID063025	10	7,23
63 x 32	DID063032	10	5,43
63 x 50	DID063050	10	5,43
75 x 63	DID075063	10	12,94
90 x 50	DID090050	10	14,49
90 x 63	DID090063	10	14,49
90 x 75	DID090075	10	14,49
110 x 63	DID110063	10	21,22
110 x 90	DID110090	10	21,22
125 x 110	DID125110	10	40,42
140 x 125	DID140125	10	67,35
160 x 90	DID160090	10	57,25
160 x 110	DID160110	10	57,25
160 x 140	DID160140	10	57,25
200 x 160	DID200160	10	77,47
225 x 160	DID225160	10	138,12
225 x 200	DID225200	10	138,12
250 x 225	DID250225	10	593,32
315 x 250	DID315250	10	912,17

Casquillo reducción.
 M-H encolar.



MFD

F1

Rh	Ref.	PN	€
1/2"	MFD012	12	14,79
3/4"	MFD034	12	16,50
1"	MFD100	12	21,17
1 1/4"	MFD114	12	28,56
1 1/2"	MFD112	12	32,25
2"	MFD200	12	40,35
3"	MFD300	12	110,93

Manguito roscado.
 H-H roscar.



NFD

F1

Rm	Ref.	PN	€
3/8"	NFD038	12	7,07
1/2"	NFD012	12	7,75
3/4"	NFD034	12	9,72
1"	NFD100	12	12,82
1 1/4"	NFD114	12	17,47
1 1/2"	NFD112	12	20,87
2"	NFD200	12	24,87

Machón roscado.
 M-M roscar.



PFD

F1

Rm	Ref.	PN	€
3/8"	PFD038	12	7,07
1/2"	PFD012	12	8,42
3/4"	PFD034	12	10,41
1"	PFD100	12	12,82
1 1/4"	PFD114	12	16,50
1 1/2"	PFD112	12	21,49
2"	PFD200	12	23,89

Tapón rosca macho.
 M roscar.



CFD

F1

Rh	Ref.	PN	€
3/8"	CFD038	12	11,44
1/2"	CFD012	12	14,79
3/4"	CFD034	12	17,17
1"	CFD100	12	18,47
1 1/4"	CFD114	12	19,52
1 1/2"	CFD112	12	25,22
2"	CFD200	12	31,96
3"	CFD300	12	107,52

Tapón rosca hembra.
 H roscar.



BIFDO

F1

d x Rh	Ref.	PN	€ EPDM
16 x 3/8"	BIFDO016038	10	25,03
20 x 1/2"	BIFDO020012	10	12,16
25 x 3/4"	BIFDO025034	10	18,22
32 x 1"	BIFDO032100	10	30,54
40 x 1 1/4"	BIFDO040114	10	30,80
50 x 1 1/2"	BIFDO050112	10	51,69
63 x 2"	BIFDO063200	10	61,60

Unión 3 piezas mixto
 ABS-Latón.
 Junta EPDM. H-H encolar-roscar.



BIRDO

F1

d x Rm	Ref.	PN	€ EPDM
16 x 3/8"	BIRDO016038	10	25,12
20 x 1/2"	BIRDO020012	10	12,46
25 x 3/4"	BIRDO025034	10	24,08
32 x 1"	BIRDO032100	10	28,78
40 x 1 1/4"	BIRDO040114	10	30,00
50 x 1 1/2"	BIRDO050112	10	65,94
63 x 2"	BIRDO063200	10	60,65

Unión 3 piezas mixto
 ABS-Latón.
 Junta EPDM. H-M encolar-roscar.



BID

d	Ref.	PN	F1 € EPDM
16	BID016	10	7,75
20	BID020	10	9,43
25	BID025	10	7,01
32	BID032	10	13,79
40	BID040	10	15,80
50	BID050	10	24,55
63	BID063	10	32,25
75	BID075	10	41,36
90	BID090	10	111,16
110	BID110	10	151,57

Unión 3 piezas.
 Junta EPDM. H-H encolar.

Bajo pedido en FKM
 Precios: Consultar



JT

d	Ref.	PN	F1 € EPDM
16	JT016	10	4,14
20	JT020	10	1,75
25	JT025	10	2,12
32	JT032	10	2,58
40	JT040	10	3,15
50	JT050	10	1,23
63	JT063	10	1,56
75	JT075	10	2,16
90	JT090	10	2,02
110	JT110	10	2,94

Junta tórica.
 EPDM.

Precios FKM Consultar



RID

dm x dh x dh	Ref.	PN	F1 €
25 x 20 x 16	RID025020016	10	3,67
32 x 25 x 20	RID032025020	10	3,72
40 x 32 x 25	RID040032025	10	4,03
50 x 40 x 32	RID050040032	10	10,31
63 x 50 x 40	RID063050040	10	11,62
75 x 63 x 50	RID075063050	10	11,76
90 x 75 x 63	RID090075063	10	22,57
110 x 90 x 75	RID110090075	10	27,95
125 x 110 x 90	RID125110090	10	37,09
140 x 125 x 110	RID140125110	10	87,12
160 x 140 x 125	RID160140125	10	90,91
200 x 160 x 140	RID200160140	10	138,12
225 x 200 x 160	RID225200160	10	198,74

Reducción cónica.
 M/H-H encolar.



RFD

Rm x Rh	Ref.	PN	F1 €
1/2" x 3/8"	RFD012038	12	8,42
3/4" x 1/2"	RFD034012	12	9,72
1" x 3/4"	RFD100034	12	12,82

Reducción roscada.
 M-H roscar.



ODDS

d	Ref.	Agujeros en base	Agujeros en brida	F1 €
16	ODDS016	2	4	9,88
20	ODDS020	2	4	119,96
25	ODDS025	2	4	17,17
32	ODDS032	2	4	51,47
50	ODDS050	2	4	61,91
63	ODDS063	2	4	55,61
75	ODDS075	2	4	92,55
90	ODDS090	2	8	108,35
110	ODDS110	3	8	124,65

Brida metal
 con base sporte.



FCD

F1

d	Ref.	PN	€
32	FCD032	10	64,04
40	FCD040	10	22,89
50	FCD050	10	41,49
63	FCD063	10	54,68
75	FCD075	10	54,68
90	FCD090	10	91,53
110	FCD110	10	123,47
125	FCD125	10	125,80
140	FCD140	10	125,80
160	FCD160	10	173,77

Brida ciega.



QPDJ

F1

d	Ref.	€ EPDM
16	QPDJ016	4,14
20	QPDJ020	1,75
25	QPDJ025	2,13
32	QPDJ032	2,62
40	QPDJ040	3,19
50	QPDJ050	1,25
63	QPDJ063	1,57
75	QPDJ075	2,18
90	QPDJ090	2,03
110	QPDJ110	3,01
125	QPDJ125	3,57
140	QPDJ140	4,22
160	QPDJ160	4,36
200	QPDJ200	7,74
225	QPDJ225	9,81
250	QPDJ250	Consultar
315	QPDJ315	Consultar

Junta plana en EPDM.
 Para manguito portabridas.



ODS

F1

d	Ref.	PN	€
16	ODS016	10/16	61,91
20	ODS020	10/16	13,49
25	ODS025	10/16	14,08
32	ODS032	10/16	15,76
40	ODS040	10/16	17,82
50	ODS050	10/16	19,55
63	ODS063	10/16	23,16
75	ODS075	10/16	27,66
90	ODS090	10/16	33,92
110	ODS110	10/16	42,06
125	ODS125	10/16	53,48
140	ODS140	10/16	63,33
160	ODS160	10/16	81,46
200	ODS200	10	78,81
225	ODS225	10	123,98
250	ODS250	10	Consultar
315	ODS315	10	Consultar

Brida metal galvanizada.



COBRA

A

d	Ref.	Pack	€
12**	COBRA012	10	0,43
16**	COBRA016	10	0,43
20**	COBRA020	10	0,86
25**	COBRA025	10	1,08
32**	COBRA032	10	1,95
40	COBRA040	10	2,60
50	COBRA050	10	2,81
63	COBRA063	10	4,34
75	COBRA075	10	8,91
90	COBRA090	10	10,62
110	COBRA110	10	14,74
125	COBRA125	10	34,33
140	COBRA140	-	31,51
160	COBRA160	-	39,75

Abrazadera para tubería.
 PP negro.

** En estos diámetros
 sin cierre superior

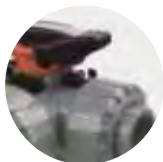

VKDID

d	Ref. EPDM	DN	PN	€ EPDM	F1 € FKM
16	VKDID016E	10	16	87,40	Consultar
20	VKDID020E	15	16	90,39	Consultar
25	VKDID025E	20	16	99,78	Consultar
32	VKDID032E	25	16	98,77	Consultar
40	VKDID040E	32	16	164,78	Consultar
50	VKDID050E	40	16	195,89	Consultar
63	VKDID063E	50	16	250,10	Consultar

Válvula de bola DUAL BLOCK®. Código en FKM termina en "F" en lugar de "E"
Asiento PTFE (teflón). Bidireccional.
H-H encolar.



TKDID

d	Ref. EPDM	DN	PN	€ EPDM	F1 € FKM
20	TKDID020E	15	16	Consultar	Consultar
25	TKDID025E	20	16	Consultar	Consultar
32	TKDID032E	25	16	Consultar	Consultar
40	TKDID040E	32	16	Consultar	Consultar
50	TKDID050E	40	16	Consultar	Consultar
63	TKDID063E	50	16	Consultar	Consultar

Válvula de bola 3 vías. Código en FKM termina en "F" en lugar de "E"
DUAL BLOCK®. PASO L.
H-H-H encolar.



VKDID

d	Ref. EPDM	DN	PN	€ EPDM	F1 € FKM
75	VKDID075E	65	16	650,33	Consultar
90	VKDID090E	80	16	740,59	Consultar
110	VKDID110E	100	16	1.025,44	Consultar

Válvula de bola DUAL BLOCK®. Código en FKM termina en "F" en lugar de "E"
Asiento PTFE (teflón). Bidireccional.
H-H encolar.



LKDID

d	Ref. EPDM	DN	PN	€ EPDM	F1 € FKM
20	LKDID020E	15	16	Consultar	Consultar
25	LKDID025E	20	16	Consultar	Consultar
32	LKDID032E	25	16	Consultar	Consultar
40	LKDID040E	32	16	Consultar	Consultar
50	LKDID050E	40	16	Consultar	Consultar
63	LKDID063E	50	16	Consultar	Consultar

Válvula de bola 3 vías. Código en FKM termina en "F" en lugar de "E"
DUAL BLOCK®. PASO L.
H-H-H encolar.



DKUID

d	Ref. EPDM	DN	€ EPDM	F1
20	DKUID020E	15	144,83	
25	DKUID025E	20	148,23	
32	DKUID032E	25	377,79	
40	DKUID040E	32	238,66	
50	DKUID050E	40	612,93	
63	DKUID063E	50	746,11	

Válvula de membrana. Disponibles con membrana en FKM y PTFE (Teflón)
Con enlaces H-H para encolar. Precios: Consultar



VMDD

d	Ref. EPDM	DN	€ EPDM	F1
90	VMDD090E	80	2.111,19	
110	VMDD110E	100	5.095,93	

Válvula de membrana. Disponibles con membrana en FKM (Vitón) y PTFE (Teflón)
M-M encolar. Precios: Consultar



FKOARM

d	Ref. EPDM	DN	G	
			€ EPDM	€ FKM
75	FKOARM075E	65	Consultar	Consultar
90	FKOARM090E	80	Consultar	Consultar
110	FKOARM110E	100	Consultar	Consultar
125	FKOARM140E	125	Consultar	Consultar
140	FKOARM140E	125	Consultar	Consultar
160	FKOARM160E	150	Consultar	Consultar
200	FKOARM225E	200	Consultar	Consultar
225	FKOARM225E	200	Consultar	Consultar
250**	FKOARM280E	250	Consultar	Consultar
280**	FKOARM280E	250	Consultar	Consultar
315**	FKOARM315E	300	Consultar	Consultar

Válvula de mariposa industrial.
CON VOLANTE.

Cuerpo en PPGR,
eje *inoxidable* y disco en ABS.

Código en FKM termina en "F"
en lugar de "E"
** ANSI 150 lbs bajo pedido
al mismo precio.



FKOALM

d	Ref. EPDM	DN	G	
			€ EPDM	€ FKM
50	FKOALM050E	40	Consultar	Consultar
63	FKOALM063E	50	Consultar	Consultar
75	FKOALM075E	65	Consultar	Consultar
90	FKOALM090E	80	Consultar	Consultar
110	FKOALM110E	100	Consultar	Consultar
125	FKOALM125E	125	Consultar	Consultar
140	FKOALM140E	125	Consultar	Consultar
160	FKOALM160E	150	Consultar	Consultar
200	FKOALM200E	200	Consultar	Consultar
225	FKOALM225E	200	Consultar	Consultar

Válvula de mariposa industrial.
CON MANETA.

Cuerpo en PPGR,
eje *inoxidable* y disco en ABS.

Código en FKM termina en "F"
en lugar de "E"



SRID

d	Ref.	DN	F1
			€ EPDM
20	SRID020	15	37,09
25	SRID025	20	55,63
32	SRID032	25	71,74
40	SRID040	32	87,58
50	SRID050	40	110,64
63	SRID063	50	153,88

Válvula de bola anti-retorno.
Juntas EPDM. H-H encolar.

Juntas FKM bajo pedido



RVUID

d	Ref.	DN	F1 € EPDM
20	RVUID020E	15	174,94
25	RVUID025E	20	170,34
32	RVUID032E	25	227,05
40	RVUID040E	32	281,02
50	RVUID050E	40	376,43
63	RVUID063E	50	476,07

Filtro inclinado.

Juntas EPDM. H-H con enlaces para encolar.



VAID

d	Ref.	DN	F1 € EPDM
20	VAID020E	15	80,88
25	VAID025E	20	101,07
32	VAID032E	25	114,54
40	VAID040E	32	165,08
50	VAID050E	40	188,65
63	VAID063E	50	232,46

Válvula de aireación

Juntas EPDM. H-H encolar.



d	Producto	F1 €
	PEG012D Pegamento 500 grs.	14,97
	DIS012D Decapante ½ l.	17,09

Pegamento y decapante.

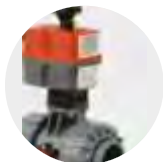

VKDID/CE

K

ACTUACIÓN ELÉCTRICA
24-240 V AC/DC

ACTUACIÓN ELÉCTRICA CON BLOQUE DE SEGURIDAD
24-240 V AC/DC

d	Ref.	€	Ref.	€
16	VKAE016E2D	609,63	VKAE016E2BD	1.104,51
20	VKAE020E2D	612,65	VKAE020E2BD	1.107,51
25	VKAE025E2D	624,77	VKAE025E2BD	1.119,63
32	VKAE032E2D	623,70	VKAE032E2BD	1.118,57
40	VKAE040E2D	696,93	VKAE040E2BD	1.191,80
50	VKAE050E2D	728,40	VKAE050E2BD	1.223,28
63	VKAE063E2D	786,43	VKAE063E2BD	1.281,31
75	VKAE075E2D	1.368,80	VKAE075E2BD	1.863,69
90	VKAE090E2D	1.460,14	VKAE090E2BD	1.955,01
110	VKAE110E2D	2.085,31	VKAE110E2BD	2.580,17

Válvula de bola motorizada en ABS 2 vías DUAL BLOCK®. Actuación eléctrica.

Manguitos para encolar (otras conexiones disponibles). Bajo pedido juntas en FKM
Bajo pedido podemos suministrar otros actuadores: VALPES, BELIMO...
Bajo pedido también disponibles en 12V AC/DC

VKDID/CP

K

ACTUACIÓN NEUMÁTICA ALUMINIO

ACTUACIÓN NEUMÁTICA ALUMINIO CON ELECTROVÁLVULA, FINALES DE CARRERA (ELECTROMECAÑICOS) Y REGULADORES DE ESCAPE

d	DOBLE EFECTO		SIMPLE EFECTO		DOBLE EFECTO		SIMPLE EFECTO	
	Ref.	€	Ref.	€	Ref.	€	Ref.	€
16	VKAP016EDED	308,35	VKAP016ESED	336,56	VKAP016EDEFD	487,37	VKAP016ESEFD	525,03
20	VKAP020EDED	311,34	VKAP020ESED	339,57	VKAP020EDEFD	490,34	VKAP020ESEFD	528,03
25	VKAP025EDED	323,46	VKAP025ESED	351,67	VKAP025EDEFD	502,46	VKAP025ESEFD	540,15
32	VKAP032EDED	322,41	VKAP032ESED	350,62	VKAP032EDEFD	501,39	VKAP032ESEFD	539,09
40	VKAP040EDED	395,64	VKAP040ESED	423,86	VKAP040EDEFD	574,64	VKAP040ESEFD	612,32
50	VKAP050EDED	427,12	VKAP050ESED	507,71	VKAP050EDEFD	606,14	VKAP050ESEFD	696,19
63	VKAP063EDED	485,13	VKAP063ESED	636,12	VKAP063EDEFD	664,15	VKAP063ESEFD	824,60
75	VKAP075EDED	923,57	VKAP075ESED	1.030,40	VKAP075EDEFD	1.102,56	VKAP075ESEFD	1.218,87
90	VKAP090EDED	1.014,90	VKAP090ESED	1.121,71	VKAP090EDEFD	1.193,90	VKAP090ESEFD	1.310,20
110	VKAP110EDED	1.327,06	VKAP110ESED	1.705,29	VKAP110EDEFD	1.506,05	VKAP110ESEFD	1.893,78

Válvula de bola motorizada en ABS 2 vías DUAL BLOCK®. Actuación neumática

Manguitos para encolar (otras conexiones disponibles). Bajo pedido juntas en FKM
Las válvulas neumáticas se configuran NC (normalmente cerrada) de serie.
La configuración NA (normalmente abierta) se debe especificar en el pedido



VKDID/CP

K

ACTUACIÓN NEUMÁTICA POLIAMIDA

ACTUACIÓN NEUMÁTICA POLIAMIDA CON ELECTROVÁLVULA, FINALES DE CARRERA (ELECTROMECÁNICOS) Y REGULADORES DE ESCAPE

d	DOBLE EFECTO		SIMPLE EFECTO		DOBLE EFECTO		SIMPLE EFECTO	
	Ref.	€	Ref.	€	Ref.	€	Ref.	€
16	VKAP016EDEP	325,35	VKAP016ESEP	345,99	VKAP016EDEFPP	559,53	VKAP016ESEFP	580,18
20	VKAP020EDEP	328,36	VKAP020ESEP	348,99	VKAP020EDEFPP	562,53	VKAP020ESEFP	583,16
25	VKAP025EDEP	340,46	VKAP025ESEP	361,10	VKAP025EDEFPP	574,64	VKAP025ESEFP	595,27
32	VKAP032EDEP	339,39	VKAP032ESEP	452,91	VKAP032EDEFPP	573,58	VKAP032ESEFP	687,07
40	VKAP040EDEP	412,65	VKAP040ESEP	526,13	VKAP040EDEFPP	646,81	VKAP040ESEFP	760,30
50	VKAP050EDEP	444,13	VKAP050ESEP	665,97	VKAP050EDEFPP	678,30	VKAP050ESEFP	900,14
63	VKAP063EDEP	684,18	VKAP063ESEP	743,53	VKAP063EDEFPP	918,36	VKAP063ESEFP	977,67
75	VKAP075EDEP	1.038,99	VKAP075ESEP	1.261,26	VKAP075EDEFPP	1.273,15	VKAP075ESEFP	1.495,42
90	VKAP090EDEP	1.130,32	VKAP090ESEP	1.352,58	VKAP090EDEFPP	1.364,49	VKAP090ESEFP	1.586,75
110	VKAP110EDEP	1.412,81	VKAP110ESEP	1.654,03	VKAP110EDEFPP	1.647,00	VKAP110ESEFP	1.888,21

Válvula de bola motorizada en ABS 2 vías DUAL BLOCK®. Actuación neumática

Manguitos para encolar (otras conexiones disponibles). Bajo pedido juntas en FKM
 Las válvulas neumáticas se configuran NC (normalmente cerrada) de serie.
 La configuración NA (normalmente abierta) se debe especificar en el pedido

LKDID/CE

ACTUACIÓN ELÉCTRICA 24-240 V AC/DC

ACTUACIÓN ELÉCTRICA CON BLOQUE DE SEGURIDAD 24-240 V AC/DC

d	Ref.	€	Ref.	€
20	LKAE020E2D	Consultar	LKAE020E2BD	Consultar
25	LKAE025E2D	Consultar	LKAE025E2BD	Consultar
32	LKAE032E2D	Consultar	LKAE032E2BD	Consultar
40	LKAE040E2D	Consultar	LKAE040E2BD	Consultar
50	LKAE050E2D	Consultar	LKAE050E2BD	Consultar
63	LKAE063E2D	Consultar	LKAE063E2BD	Consultar

Válvula de bola motorizada en ABS 3 vías DUAL BLOCK®. Actuación eléctrica.

Estándar paso en L, paso en T opcional al mismo precio. Manguitos para encolar (otras conexiones disponibles).
 Bajo pedido juntas en FKM Bajo pedido podemos suministrar otros actuadores: VALPES, BELIMO...
 Bajo pedido también disponibles en 12V AC/DC



K



LKDID/CP

K

ACTUACIÓN NEUMÁTICA ALUMINIO

ACTUACIÓN NEUMÁTICA ALUMINIO CON ELECTROVÁLVULA, FINALES DE CARRERA (ELECTROMECAÑICOS) Y REGULADORES DE ESCAPE

d-Rh	DOBLE EFECTO		SIMPLE EFECTO		DOBLE EFECTO		SIMPLE EFECTO	
	Ref.	€	Ref.	€	Ref.	€	Ref.	€
20	LKAP020EDED	Consultar	LKAP020ESED	Consultar	LKAP020EDEFD	Consultar	LKAP020ESEFD	Consultar
25	LKAP025EDED	Consultar	LKAP025ESED	Consultar	LKAP025EDEFD	Consultar	LKAP025ESEFD	Consultar
32	LKAP032EDED	Consultar	LKAP032ESED	Consultar	LKAP032EDEFD	Consultar	LKAP032ESEFD	Consultar
40	LKAP040EDED	Consultar	LKAP040ESED	Consultar	LKAP040EDEFD	Consultar	LKAP040ESEFD	Consultar
50	LKAP050EDED	Consultar	LKAP050ESED	Consultar	LKAP050EDEFD	Consultar	LKAP050ESEFD	Consultar
63	LKAP063EDED	Consultar	LKAP063ESED	Consultar	LKAP063EDEFD	Consultar	LKAP063ESEFD	Consultar

Válvula de bola motorizada en ABS 3 vías DUAL BLOCK®.

Actuación neumática

Estándar paso en L, paso en T opcional al mismo precio
 Manguitos para encolar (otras conexiones disponibles). Bajo pedido juntas en FKM
 Las válvulas neumáticas se configuran NC (normalmente cerrada) de serie.
 La configuración NA (normalmente abierta) se debe especificar en el pedido

LKDID/CP

K

ACTUACIÓN NEUMÁTICA POLIAMIDA

ACTUACIÓN NEUMÁTICA POLIAMIDA CON ELECTROVÁLVULA, FINALES DE CARRERA (ELECTROMECAÑICOS) Y REGULADORES DE ESCAPE

d-Rh	DOBLE EFECTO		SIMPLE EFECTO		DOBLE EFECTO		SIMPLE EFECTO	
	Ref.	€	Ref.	€	Ref.	€	Ref.	€
20	LKAP020EDEP	Consultar	LKAP020ESEP	Consultar	LKAP020EDEFPP	Consultar	LKAP020ESEFP	Consultar
25	LKAP025EDEP	Consultar	LKAP025ESEP	Consultar	LKAP025EDEFPP	Consultar	LKAP025ESEFP	Consultar
32	LKAP032EDEP	Consultar	LKAP032ESEP	Consultar	LKAP032EDEFPP	Consultar	LKAP032ESEFP	Consultar
40	LKAP040EDEP	Consultar	LKAP040ESEP	Consultar	LKAP040EDEFPP	Consultar	LKAP040ESEFP	Consultar
50	LKAP050EDEP	Consultar	LKAP050ESEP	Consultar	LKAP050EDEFPP	Consultar	LKAP050ESEFP	Consultar
63	LKAP063EDEP	Consultar	LKAP063ESEP	Consultar	LKAP063EDEFPP	Consultar	LKAP063ESEFP	Consultar

Válvula de bola motorizada en ABS 3 vías DUAL BLOCK®.

Actuación neumática

Estándar paso en L, paso en T opcional al mismo precio
 Manguitos para encolar (otras conexiones disponibles). Bajo pedido juntas en FKM
 Las válvulas neumáticas se configuran NC (normalmente cerrada) de serie.
 La configuración NA (normalmente abierta) se debe especificar en el pedido



FKOA/CE

K

ACTUACIÓN ELÉCTRICA 24-240 V AC/DC

ACTUACIÓN ELÉCTRICA CON BLOQUE DE SEGURIDAD 24-240 V AC/DC

d	Ref.	€	Ref.	€
50	FKAE050E2D	Consultar	FKAE050E2BD	Consultar
63	FKAE063E2D	Consultar	FKAE063E2BD	Consultar
75	FKAE075E2D	Consultar	FKAE075E2BD	Consultar
90	FKAE090E2D	Consultar	FKAE090E2BD	Consultar
110	FKAE110E2D	Consultar	FKAE110E2BD	Consultar
125	FKAE140E2D	Consultar	FKAE140E2BD	Consultar
140	FKAE140E2D	Consultar	FKAE140E2BD	Consultar
160	FKAE160E2D	Consultar	FKAE160E2BD	Consultar
200	FKAE225E2D	Consultar	FKAE225E2BD	Consultar
225	FKAE225E2D	Consultar	FKAE225E2BD	Consultar
250	FKAE280E2D	Consultar	FKAE280E2BD	Consultar
280	FKAE280E2D	Consultar	FKAE280E2BD	Consultar
315	FKAE315E2D	Consultar	FKAE315E2BD	Consultar
		€	€	
50	FKAE050F2D	Consultar	FKAE050F2BD	Consultar
63	FKAE063F2D	Consultar	FKAE063F2BD	Consultar
75	FKAE075F2D	Consultar	FKAE075F2BD	Consultar
90	FKAE090F2D	Consultar	FKAE090F2BD	Consultar
110	FKAE110F2D	Consultar	FKAE110F2BD	Consultar
125	FKAE140F2D	Consultar	FKAE140F2BD	Consultar
140	FKAE140F2D	Consultar	FKAE140F2BD	Consultar
160	FKAE160F2D	Consultar	FKAE160F2BD	Consultar
200	FKAE225F2D	Consultar	FKAE225F2BD	Consultar
225	FKAE225F2D	Consultar	FKAE225F2BD	Consultar
250	FKAE280F2D	Consultar	FKAE280F2BD	Consultar
280	FKAE280F2D	Consultar	FKAE280F2BD	Consultar
315	FKAE315F2D	Consultar	FKAE315F2BD	Consultar

Válvula de mariposa industrial motorizada
 cuerpo en PPGR y disco en ABS.
 Actuación eléctrica

Bajo pedido podemos suministrar otros actuadores: VALPES, BELIMO...
 Bajo pedido también disponibles en 12V AC/DC



FKOA/CP

K

ACTUACIÓN NEUMÁTICA ALUMINIO

ACTUACIÓN NEUMÁTICA ALUMINIO CON ELECTROVÁLVULA, FINALES DE CARRERA (ELECTROMECAÑICOS) Y REGULADORES DE ESCAPE

d	DOBLE EFECTO		SIMPLE EFECTO		DOBLE EFECTO		SIMPLE EFECTO	
	Ref.	€	Ref.	€	Ref.	€	Ref.	€
50	FKAP050EDED	Consultar	FKAP050ESED	Consultar	FKAP050EDEFD	Consultar	FKAP050ESEFD	Consultar
63	FKAP063EDED	Consultar	FKAP063ESED	Consultar	FKAP063EDEFD	Consultar	FKAP063ESEFD	Consultar
75	FKAP075EDED	Consultar	FKAP075ESED	Consultar	FKAP075EDEFD	Consultar	FKAP075ESEFD	Consultar
90	FKAP090EDED	Consultar	FKAP090ESED	Consultar	FKAP090EDEFD	Consultar	FKAP090ESEFD	Consultar
110	FKAP110EDED	Consultar	FKAP110ESED	Consultar	FKAP110EDEFD	Consultar	FKAP110ESEFD	Consultar
125	FKAP140EDED	Consultar	FKAP140ESED	Consultar	FKAP140EDEFD	Consultar	FKAP140ESEFD	Consultar
140	FKAP140EDED	Consultar	FKAP140ESED	Consultar	FKAP140EDEFD	Consultar	FKAP140ESEFD	Consultar
160	FKAP160EDED	Consultar	FKAP160ESED	Consultar	FKAP160EDEFD	Consultar	FKAP160ESEFD	Consultar
200	FKAP225EDED	Consultar	FKAP225ESED	Consultar	FKAP225EDEFD	Consultar	FKAP225ESEFD	Consultar
225	FKAP225EDED	Consultar	FKAP225ESED	Consultar	FKAP225EDEFD	Consultar	FKAP225ESEFD	Consultar
250	FKAP280EDED	Consultar	FKAP280ESED	Consultar	FKAP280EDEFD	Consultar	FKAP280ESEFD	Consultar
280	FKAP280EDED	Consultar	FKAP280ESED	Consultar	FKAP280EDEFD	Consultar	FKAP280ESEFD	Consultar
315	FKAP315EDED	Consultar	FKAP315ESED	Consultar	FKAP315EDEFD	Consultar	FKAP315ESEFD	Consultar

50	FKAP050FDED	Consultar	FKAP050FSED	Consultar	FKAP050FDEFD	Consultar	FKAP050FSEFD	Consultar
63	FKAP063FDED	Consultar	FKAP063FSED	Consultar	FKAP063FDEFD	Consultar	FKAP063FSEFD	Consultar
75	FKAP075FDED	Consultar	FKAP075FSED	Consultar	FKAP075FDEFD	Consultar	FKAP075FSEFD	Consultar
90	FKAP090FDED	Consultar	FKAP090FSED	Consultar	FKAP090FDEFD	Consultar	FKAP090FSEFD	Consultar
110	FKAP110FDED	Consultar	FKAP110FSED	Consultar	FKAP110FDEFD	Consultar	FKAP110FSEFD	Consultar
125	FKAP140FDED	Consultar	FKAP140FSED	Consultar	FKAP140FDEFD	Consultar	FKAP140FSEFD	Consultar
140	FKAP140FDED	Consultar	FKAP140FSED	Consultar	FKAP140FDEFD	Consultar	FKAP140FSEFD	Consultar
160	FKAP160FDED	Consultar	FKAP160FSED	Consultar	FKAP160FDEFD	Consultar	FKAP160FSEFD	Consultar
200	FKAP225FDED	Consultar	FKAP225FSED	Consultar	FKAP225FDEFD	Consultar	FKAP225FSEFD	Consultar
225	FKAP225FDED	Consultar	FKAP225FSED	Consultar	FKAP225FDEFD	Consultar	FKAP225FSEFD	Consultar
250	FKAP280FDED	Consultar	FKAP280FSED	Consultar	FKAP280FDEFD	Consultar	FKAP280FSEFD	Consultar
280	FKAP280FDED	Consultar	FKAP280FSED	Consultar	FKAP280FDEFD	Consultar	FKAP280FSEFD	Consultar
315	FKAP315FDED	Consultar	FKAP315FSED	Consultar	FKAP315FDEFD	Consultar	FKAP315FSEFD	Consultar

Válvula de mariposa industrial motorizada
 cuerpo en PPGR y disco en ABS.
 Actuación neumática

Las válvulas neumáticas se configuran NC (normalmente cerrada) de serie.
 La configuración NA (normalmente abierta) se debe especificar en el pedido



FKOA/CP

K

ACTUACIÓN NEUMÁTICA POLIAMIDA

ACTUACIÓN NEUMÁTICA POLIAMIDA CON ELECTROVÁLVULA, FINALES DE CARRERA (ELECTROMECAÑICOS) Y REGULADORES DE ESCAPE

d	DOBLE EFECTO		SIMPLE EFECTO		DOBLE EFECTO		SIMPLE EFECTO	
	Ref.	€	Ref.	€	Ref.	€	Ref.	€
50	FKAP050EDEP	Consultar	FKAP050ESEP	Consultar	FKAP050EDEFP	Consultar	FKAP050ESEFP	Consultar
63	FKAP063EDEP	Consultar	FKAP063ESEP	Consultar	FKAP063EDEFP	Consultar	FKAP063ESEFP	Consultar
75	FKAP075EDEP	Consultar	FKAP075ESEP	Consultar	FKAP075EDEFP	Consultar	FKAP075ESEFP	Consultar
90	FKAP090EDEP	Consultar	FKAP090ESEP	Consultar	FKAP090EDEFP	Consultar	FKAP090ESEFP	Consultar
110	FKAP110EDEP	Consultar	FKAP110ESEP	Consultar	FKAP110EDEFP	Consultar	FKAP110ESEFP	Consultar
125	FKAP140EDEP	Consultar	FKAP140ESEP	Consultar	FKAP140EDEFP	Consultar	FKAP140ESEFP	Consultar
140	FKAP140EDEP	Consultar	FKAP140ESEP	Consultar	FKAP140EDEFP	Consultar	FKAP140ESEFP	Consultar
160	FKAP160EDEP	Consultar	FKAP160ESEP	Consultar	FKAP160EDEFP	Consultar	FKAP160ESEFP	Consultar
200	FKAP225EDEP	Consultar	FKAP225ESEP	Consultar	FKAP225EDEFP	Consultar	FKAP225ESEFP	Consultar
225	FKAP225EDEP	Consultar	FKAP225ESEP	Consultar	FKAP225EDEFP	Consultar	FKAP225ESEFP	Consultar
250 *	FKAP280EDEP	Consultar	FKAP280ESEP	Consultar	FKAP280EDEFP	Consultar	FKAP280ESEFP	Consultar
280 *	FKAP280EDEP	Consultar	FKAP280ESEP	Consultar	FKAP280EDEFP	Consultar	FKAP280ESEFP	Consultar
315 *	FKAP315EDEP	Consultar	FKAP315ESEP	Consultar	FKAP315EDEFP	Consultar	FKAP315ESEFP	Consultar

50	FKAP050FDEP	Consultar	FKAP050FSEP	Consultar	FKAP050FDEFP	Consultar	FKAP050FSEFP	Consultar
63	FKAP063FDEP	Consultar	FKAP063FSEP	Consultar	FKAP063FDEFP	Consultar	FKAP063FSEFP	Consultar
75	FKAP075FDEP	Consultar	FKAP075FSEP	Consultar	FKAP075FDEFP	Consultar	FKAP075FSEFP	Consultar
90	FKAP090FDEP	Consultar	FKAP090FSEP	Consultar	FKAP090FDEFP	Consultar	FKAP090FSEFP	Consultar
110	FKAP110FDEP	Consultar	FKAP110FSEP	Consultar	FKAP110FDEFP	Consultar	FKAP110FSEFP	Consultar
125	FKAP140FDEP	Consultar	FKAP140FSEP	Consultar	FKAP140FDEFP	Consultar	FKAP140FSEFP	Consultar
140	FKAP140FDEP	Consultar	FKAP140FSEP	Consultar	FKAP140FDEFP	Consultar	FKAP140FSEFP	Consultar
160	FKAP160FDEP	Consultar	FKAP160FSEP	Consultar	FKAP160FDEFP	Consultar	FKAP160FSEFP	Consultar
200	FKAP225FDEP	Consultar	FKAP225FSEP	Consultar	FKAP225FDEFP	Consultar	FKAP225FSEFP	Consultar
225	FKAP225FDEP	Consultar	FKAP225FSEP	Consultar	FKAP225FDEFP	Consultar	FKAP225FSEFP	Consultar
250 *	FKAP280FDEP	Consultar	FKAP280FSEP	Consultar	FKAP280FDEFP	Consultar	FKAP280FSEFP	Consultar
280 *	FKAP280FDEP	Consultar	FKAP280FSEP	Consultar	FKAP280FDEFP	Consultar	FKAP280FSEFP	Consultar
315 *	FKAP315FDEP	Consultar	FKAP315FSEP	Consultar	FKAP315FDEFP	Consultar	FKAP315FSEFP	Consultar

Válvula de mariposa industrial motorizada
 cuerpo en PPGR y disco en ABS.
 Actuación neumática

Las válvulas neumáticas se configuran NC (normalmente cerrada) de serie.
 La configuración NA (normalmente abierta) se debe especificar en el pedido
 * Actuadores de aluminio



INDUSTRIA

Sistema ABS

Válvulas de presión

Durapipe



LR

d	DN	Ref. EPDM	€ EPDM	Ref. FKM	€ FKM	Ref. PTFE	L € PTFE
16	10	HOLRA305	Consultar	HOLRB305	Consultar	HOLRC305	Consultar
20	15	HOLRA306	Consultar	HOLRB306	Consultar	HOLRC306	Consultar
25	20	HOLRA307	Consultar	HOLRB307	Consultar	HOLRC307	Consultar
32	25	HOLRA308	Consultar	HOLRB308	Consultar	HOLRC308	Consultar
40	32	HOLRA309	Consultar	HOLRB309	Consultar	HOLRC309	Consultar
50	40	HOLRA310	Consultar	HOLRB310	Consultar	HOLRC310	Consultar
63	50	HOLRA311	Consultar	HOLRB311	Consultar	HOLRC311	Consultar

Válvula para carga y alivio de presión.

Dos funciones en la misma válvula.

H-H con enlaces encolar.

Rango de calibración presión: 0 - 3 bars

Rango de calibración alivio: 0 - 10 bars

Accesorios mecánicos para la unión de tuberías

INDUSTRIA



Accesorios mecánicos





METAL GRIP

J1

diámetro exterior	PN (bar)	PN (bar)	CARCASA EN ACERO GALVANIZADO				CARCASA EN ACERO INOXIDABLE			
			Ref. EPDM	€ EPDM	Ref. NBR	€ NBR	Ref. EPDM	€ EPDM	Ref. NBR	€ NBR
30,0	67,0	16,0	50	133,34	51	133,34	58	158,80	57	158,80
33,7	62,0	16,0	86	134,27	123	134,27	126	160,38	127	160,38
38,0	58,0	16,0	110	134,92	122	134,92	40100	160,38	40101	160,38
42,4	53,0	16,0	11045	136,00	11047	136,00	40150	161,96	40151	161,96
44,5	48,0	16,0	129	136,79	130	136,79	40200	161,96	40201	161,96
48,3	44,0	16,0	11048	138,86	11050	138,86	40250	163,53	40251	163,53
54,0	39,0	16,0	8669	139,62	8671	139,62	8668	165,11	8670	165,11
57,0	37,0	16,0	11052	140,73	11051	140,73	11043	166,68	11053	166,68
60,3	37,0	16,0	11054	143,40	11056	143,40	11044	168,25	11055	168,25
63,5	37,0	16,0	209	148,75	210	148,75	211	174,55	212	174,55
73,0	56,0	16,0	186	166,68	187	166,68	104105	198,14	192	198,14
76,1	56,0	16,0	215	169,82	155	169,82	40450	201,28	40451	201,28
84,0	45,0	16,0	216	180,84	156	180,84	104060	210,71	102278	210,71
88,9	41,0	16,0	135	182,39	157	182,39	40550	213,84	40551	213,84
104,0	37,0	16,0	136	202,83	158	202,83	173	231,15	197	231,15
108,0	35,0	16,0	137	205,98	159	205,98	40650	234,30	40661	234,30
114,3	34,0	16,0	138	215,44	160	215,44	40700	245,31	40701	245,31
129,0	33,0	16,0	139	290,90	161	290,90	40600	341,22	40601	341,22
133,0	33,0	16,0	140	298,77	162	298,77	40602	347,51	40603	347,51
139,7	32,0	16,0	141	331,78	163	331,78	40614	382,10	40611	382,10
154,0	32,0	16,0	142	364,80			40622	415,12		
159,0	31,0	16,0	143	369,51	165	369,51	40634	419,83	40631	419,83
168,3	29,0	16,0	144	393,10	166	393,10	40655	441,85	40652	441,85
180,0	29,0	16,0	1650	702,86	1651	702,86				
193,7	29,0	16,0	1537	720,15	1542	720,15				
200,0	28,0	15,0	1652	729,62	1653	729,62				
206,0	28,0	15,0	1641	737,46	1654	737,46				
219,1	26,0	16,0	145	784,62	167	784,62	41050	877,39	41051	877,39
244,5	27,0	14,0	1572	790,92	1573	790,92				
267,0	24,0	12,0	1574	820,78	1575	820,78				
273,0	21,0	12,0	1567	855,39	1568	855,39				
323,9	18,0	10,0	1576	900,99	1577	900,99				
355,6	17,0	8,0	1579	940,30	1578	940,30				
406,4	14,0	8,0	1607	1.020,50	1608	1.020,50				
457,2	8,0	6,0	1609	1.102,26	1610	1.102,26				
508,0	6,0	5,0	1611	1.188,75	1612	1.188,75				
558,8	6,0	4,5	1613	1.275,21	1614	1.275,21				
609,6	5,0	4,0	1615	1.361,70	1616	1.361,70				

Acoplamiento para tubos metálicos con anclaje axial.
Acoplamiento para muy alta presión de alta calidad.
Máximo rendimiento.

Junta: EPDM: -30°C hasta +100°C NBR: -20°C hasta +80°C
Fluido: EPDM: Todas las calidades de agua, aguas residuales, aire, sólidos y diversos productos químicos
NBR: Agua, gas, aceite, combustible y otros hidrocarburos



METAL GRIP FIRE FENCE

J1

diámetro exterior	PN (bar)	PN (bar)	CARCASA EN ACERO GALVANIZADO				CARCASA EN ACERO INOXIDABLE			
			Ref. EPDM	€ EPDM	Ref. NBR	€ NBR	Ref. EPDM	€ EPDM	Ref. NBR	€ NBR
30,0	67,0	16,0	19299	213,84	19349	213,84	105039	237,44	105026	237,44
33,7	62,0	16,0	19300	215,44	19350	215,44	105040	239,00	105027	239,00
38,0	58,0	16,0	19301	216,99	19351	216,99	105041	240,58	105028	240,58
42,4	53,0	16,0	19302	218,57	19352	218,57	105042	243,71	105029	243,71
44,5	48,0	16,0	19303	218,57	19353	218,57	40206	243,71	105030	243,71
48,3	44,0	16,0	19304	220,14	19354	220,14	105043	245,31	105031	245,31
54,0	39,0	16,0	19305	223,28	19355	223,28	19405	251,60	19455	251,60
57,0	37,0	16,0	19306	223,28	19356	223,28	19406	251,60	19456	251,60
60,3	37,0	16,0	19307	226,42	19357	226,42	19407	254,74	19457	254,74
63,5	37,0	16,0	19433	228,01	19432	228,01	19430	256,29	19431	256,29
76,1	56,0	16,0	19308	257,88	19358	257,88	105044	286,17	105032	286,17
84,0	45,0	16,0	19309	268,90	19359	268,90	19551	298,77	19552	298,77
88,9	41,0	16,0	19310	270,45	19360	270,45	105045	300,33	105033	300,33
104,0	37,0	16,0	19311	290,90	19361	290,90	19571	322,36	19572	322,36
108,0	35,0	16,0	19312	292,46	19362	292,46	105046	323,91	105034	323,91
114,3	34,0	16,0	19314	311,34	19364	311,34	105047	339,64	105035	339,64
129,0	33,0	16,0	19315	427,70	19365	427,70	19585	478,01	19568	478,01
133,0	33,0	16,0	19316	433,99	19366	433,99	19594	484,30	19593	484,30
139,7	32,0	16,0	19317	501,61	19367	501,61	105048	551,92	105036	551,92
154,0	32,0	16,0	19318	555,07			19601	605,38		
159,0	31,0	16,0	19319	561,35	19369	561,35	19603	611,68	19604	611,68
168,3	29,0	16,0	19321	600,66	19371	600,66	105049	650,97	19635	650,97
219,1	26,0	16,0	19323	1.191,88	19373	1.191,88	105050	1.287,81	105038	1.287,81
244,5	27,0	14,0	19324	1.396,30	19378	1.396,30				
267,0	24,0	12,0	19325	1.441,90	19380	1.441,90				
273,0	21,0	12,0	19326	1.476,49	19379	1.476,49				
323,9	18,0	10,0	19327	1.553,55	19381	1.553,55				
355,6	17,0	8,0	19328	1.625,88	19383	1.625,88				
406,4	14,0	8,0	19329	1.753,23	19384	1.753,23				
457,2	8,0	6,0	19330	1.888,47	19385	1.888,47				

Acoplamiento para tubos metálicos con anclaje axial y con protección al fuego.

Acoplamientos para muy alta presión de alta calidad.
Máximo rendimiento.



Junta: EPDM: -30°C hasta +100°C NBR: -20°C hasta +80°C

Fluido: EPDM: Todas las calidades de agua, aguas residuales, aire, sólidos y diversos productos químicos
NBR: Agua, gas, aceite, combustible y otros hidrocarburos



GRIP

J1



diámetro exterior	 		CARCASA EN ACERO INOXIDABLE					
	PN (bar)	PN (bar)	Ref. EPDM	€ EPDM	Ref. NBR	€ NBR	Ref. FKM	€ FKM
25,0	64,0	16,0	G20041	58,19	G20040	58,19	G20043	127,04
26,9	58,0	16,0	G20000	59,12	G20001	59,12	G20011	127,98
28,0	50,0	16,0	G20025	59,75	G20026	59,75	G20027	128,63
30,0	42,0	16,0	G20050	60,70	G20051	60,70	G20054	129,58
33,7	39,0	16,0	G20100	62,56	G20101	62,56	G20110	129,58
35,0	37,0	16,0	G20124	65,57	G20125	65,57	G20126	129,58
38,0	36,0	16,0	G20150	72,32	G20151	72,32	G20164	129,58
40,0	35,0	16,0	G20175	73,27	G20176	73,27	G20177	130,37
42,4	33,0	16,0	G20200	74,38	G20201	74,38	G20206	131,13
44,5	30,0	16,0	G20250	76,11	G20251	76,11	G20253	131,13
48,3	28,0	16,0	G20300	78,00	G20301	78,00	G20306	132,87
54,0	24,0	16,0	G20350	87,42	G20351	87,42	G20360	132,87
57,0	23,0	16,0	G20400	89,62	G20401	89,62	G20406	136,00
60,3	23,0	16,0	G20450	91,36	G20451	91,36	G20456	139,32
63,0	23,0	16,0	G20425	100,17	G20426	100,17	G20427	153,77
66,6	22,0	16,0	G20470	111,95	G20471	111,95	G20476	172,96
70,0	22,0	16,0	G20485	113,67	G20486	113,67	G20494	174,55
73,0	21,0	16,0	G20500	116,52	G20501	116,52	G20506	174,55
76,1	35,0	16,0	G20550	119,03	G20551	119,03	G20558	177,68
79,5	32,0	16,0	G20570	121,23	G20583	121,23	G20584	179,72
84,0	29,0	16,0	G20600	124,69	G20601	124,69	G20606	180,84
88,9	26,0	16,0	G20650	128,31	G20651	128,31	G20656	185,54
95,0	24,0	16,0	G20667	130,83	G20677	130,83	G20678	188,70
98,0	24,0	16,0	G20690	132,06	G20691	132,06	G20692	188,70
100,6	23,0	16,0	G20700	133,17	G20701	133,17	G20706	190,25
101,6	23,0	16,0	G20750	133,66	G20751	133,66		
104,0	23,0	16,0	G20800	133,66	G20801	133,66		
104,8	23,0	16,0	G20825	135,08	G20826	135,08		
108,0	22,0	16,0	G20850	137,91	G20851	137,91	G20865	191,85
114,3	22,0	16,0	G20900	141,99	G20901	141,99	G20906	194,99
118,0	22,0	16,0	G20930	144,34	G20931	144,34	G20932	196,54
125,0	21,0	16,0	G20940	201,28	G20941	201,28	G20942	210,71

Acoplamiento para tubos metálicos
con anclaje axial.

Acoplamientos para alta presión de alta calidad.

Continúa en la página siguiente...

J1

diámetro exterior	 PN (bar)	 PN (bar)	CARCASA EN ACERO INOXIDABLE					
			Ref. EPDM	€ EPDM	Ref. NBR	€ NBR	Ref. FKM	€ FKM
127,0	21,0	16,0	G20950	202,83	G20951	202,83	G20957	216,99
129,0	21,0	16,0	G21000	204,41	G21001	204,41	G21006	226,42
130,2	21,0	16,0	G21050	204,41	G21051	204,41	G21052	231,15
133,0	21,0	16,0	G21100	205,98	G21101	205,98	G21112	245,31
139,7	20,0	16,0	G21150	210,71	G21151	210,71	G21165	275,18
141,3	20,0	16,0	G21200	212,27	G21201	212,27	G21208	281,47
144,0	20,0	16,0	G21225	213,84	G21226	213,84	G21227	294,05
154,0	18,0	16,0	G21250	218,57	G21251	218,57	G21262	339,64
159,0	18,0	16,0	G21300	221,72	G21301	221,72	G21309	363,23
165,0	16,0	16,0	G21328	226,42	G21326	226,42	G21331	389,94
168,3	16,0	16,0	G21350	228,01	G21351	228,01	G21369	405,69
219,1	16,0	10,0	21400	399,38	21401	399,38	21408	526,75
180,0	16,0	10,0	24950	559,76	24952	559,76	24955	594,37
193,7	16,0	10,0	25000	573,92	25002	573,92	25007	606,94
200,0	15,0	10,0	25010	580,21	25012	580,21	25015	613,22
204,0	14,0	10,0	25050	581,80	25052	581,80	25049	617,97
206,0	14,0	5,5	25058	581,80	25068	581,80	25072	617,97
244,5	9,0	5,5	25100	594,37	25102	594,37	25106	635,26
250,0	9,0	5,5	25110	597,51	25112	597,51	25115	644,68
254,0	9,0	5,5	25125	600,66	25127	600,66	25131	650,97
256,0	9,0	5,5	25140	600,66	25143	600,66	25145	650,97
267,0	8,0	5,0	25150	606,94	25152	606,94	25157	671,43
273,0	7,0	4,0	25200	608,53	25202	608,53	25207	680,85
306,0	6,0	3,0	25260	625,83	25263	625,83	25265	729,62
323,9	5,0	3,0	25300	639,96	25302	639,96	25309	761,04
355,6	10,0	2,5	25353	671,43	25352	671,43	25351	1.062,95
406,4	7,0	2,0	25413	718,60	25403	718,60	25402	1.136,86
457,2	5,0		25434	768,91	25435	768,91	25436	1.218,62
508,0	4,0		25453	816,08	25452	816,08	25462	1.290,97
558,8	3,0		25483	864,83	25484	864,83	25485	1.369,57
609,6	2,0		25517	912,00	25518	912,00	25519	1.448,20
711,2	1,0		26001	1.011,05	26002	1.011,05	26003	1.605,44

Junta: EPDM: -20°C hasta +100°C NBR: -20°C hasta +80°C FKM: -20°C hasta +180°C



Fluido: EPDM: Todas las calidades de agua, aguas residuales, aire, sólidos y diversos productos químicos
 NBR: Agua, gas, aceite, combustible y otros hidrocarburos
 FKM: Ozono, oxígeno, ácidos, gas, aceite y carburantes



GRIP

J1

CARCASA EN ACERO GALVANIZADO

diámetro exterior	 PN (bar)	 PN (bar)	Ref. EPDM	€ EPDM	Ref. NBR	€ NBR	Ref. FKM	€ FKM
180,0	16,0	10,0	24951	511,05	24953	511,05	24954	545,64
193,7	16,0	10,0	25001	525,18	25003	525,18	25006	558,21
200,0	15,0	10,0	25011	531,47	25013	531,47	25014	564,51
204,0	14,0	10,0	25051	533,03	25053	533,03	25048	570,78
206,0	14,0	5,5	25066	533,03	25067	533,03	25069	570,78
244,5	9,0	5,5	25101	545,64	25103	545,64	25105	586,50
250,0	9,0	5,5	25111	550,34	25113	550,34	25114	595,94
254,0	9,0	5,5	25126	551,92	25128	551,92	25132	602,24
256,0	9,0	5,5	25141	551,92	25142	551,92	25144	602,24
267,0	8,0	5,0	25151	558,21	25153	558,21	25156	624,24
273,0	7,0	4,0	25201	559,76	25203	559,76	25198	632,10
306,0	6,0	3,0	25261	577,07	25262	577,07	25264	680,85
323,9	5,0	3,0	25301	591,22	25303	591,22	25315	712,30
355,6	10,0	2,5	101099	624,24	101100	624,24	101101	996,92
406,4	7,0	2,0	101102	669,86	101103	669,86	101104	1.072,39
457,2	5,0		101105	720,15	101106	720,15	101107	1.152,59
508,0	4,0		101108	765,77	101109	765,77	101110	1.226,48
558,8	3,0		101111	816,08	101112	816,08	101113	1.305,08
609,6	2,0		101114	864,83	101115	864,83	101116	1.383,73
711,2	1,0		26000	963,90	101117	963,90	101118	1.540,97

Acoplamiento para tubos metálicos con anclaje axial.

Acoplamientos para alta presión de alta calidad.

Junta: EPDM: -20°C hasta +100°C NBR: -20°C hasta +80°C FKM: -20°C hasta +180°C

Fluido: EPDM: Todas las calidades de agua, aguas residuales, aire, sólidos y diversos productos químicos

NBR: Agua, gas, aceite, combustible y otros hidrocarburos

FKM: Ozono, oxígeno, ácidos, gas, aceite y carburantes



GRIP stepped coupling

J1

d. exterior tubo 1	d. exterior tubo 2	PN (bar)	CARCASA EN ACERO INOXIDABLE					
			Ref. EPDM	€ EPDM	Ref. NBR	€ NBR	Ref. FKM (1)	€ FKM
50,8	48,3	24,0	100613	138,38	100688	139,16	100893	186,55
54,0	50,8	24,0	100651	141,52	100689	142,45	100894	188,06
60,3	57,0	24,0	100664	147,82	100690	148,31	100895	197,24
76,1	73,0	24,0	100665	166,68	100691	166,68	100896	224,77
88,9	84,0	22,0	100670	171,40	100692	171,24	100897	227,83
104,0	101,6	22,0	100673	179,24	100693	178,88		
108,0	104,8	21,0	100680	182,39	100694	181,96	100899	237,00
114,3	108,0	16,0	100681	193,41	100695	194,18	100900	247,71
139,7	133,0	16,0	100682	298,77	100696	299,70	100901	363,92
159,0	154,0	16,0	100683	322,36	100697	322,64	100902	464,83
168,3	159,0	16,0	100686	342,77	100698	344,02	100903	521,41

Acoplamiento con anclaje axial.

Para compensar diferentes diámetros
de tubos metálicos

(1) acoplamiento con anillo interior en acero inoxidable incorporado

Junta: EPDM: -20°C hasta +100°C NBR: -20°C hasta +80°C FKM: -20°C hasta +180°C



Fluido: EPDM: Todas las calidades de agua, aguas residuales, aire, sólidos y diversos productos químicos
 NBR: Agua, gas, aceite, combustible y otros hidrocarburos
 FKM: Ozono, oxígeno, ácidos, gas, aceite y carburantes



GRIP FIRE FENCE

J1

CARCASA EN ACERO INOXIDABLE



diámetro exterior	 PN (bar)	 PN (bar)	Ref. EPDM	€ EPDM	Ref. NBR	€ NBR	Ref. FKM	€ FKM
25,0	64,0	16,0	G20044	136,06	G20042	136,06	G20045	183,77
26,9	58,0	16,0	G20007	137,02	G20008	137,02	G20013	183,77
28,0	50,0	16,0	G20028	137,02	G20029	137,02	G20030	185,14
30,0	42,0	16,0	G20056	137,02	G20057	137,02	G20058	185,14
33,7	39,0	16,0	G20108	137,02	G20109	137,02	G20114	185,14
35,0	37,0	16,0	G20127	138,51	G20128	138,51	G20129	186,52
38,0	36,0	16,0	G20157	138,51	G20158	138,51	G20165	187,90
40,0	35,0	16,0	G20178	138,51	G20179	138,51	G20180	189,27
42,4	33,0	16,0	G20209	138,51	G20210	138,51	G20214	190,65
44,5	30,0	16,0	G20258	138,51	G20259	138,51	G20263	190,65
48,3	28,0	16,0	G20310	139,88	G20311	139,88	G20318	192,00
54,0	24,0	16,0	G20358	142,64	G20359	142,64	G20362	193,38
57,0	23,0	16,0	G20408	142,64	G20409	142,64	G20412	196,13
60,3	23,0	16,0	G20464	145,37	G20465	145,37	G20448	196,13
63,0	23,0	16,0	G20428	149,49	G20429	149,49	G20430	201,60
66,6	22,0	16,0	G20474	154,98	G20475	154,98	G20477	208,46
70,0	22,0	16,0	G20492	160,46	G20493	160,46	G20495	218,06
73,0	21,0	16,0	G20508	165,94	G20509	165,94	G20510	220,80
76,1	35,0	16,0	G20567	171,43	G20568	171,43	G20581	223,55
79,5	32,0	16,0	G20574	175,55	G20575	175,55	G20582	227,66
84,0	29,0	16,0	G20607	179,66	G20608	179,66	G20613	231,77
88,9	26,0	16,0	G20664	181,03	G20665	181,03	G20676	231,77
95,0	24,0	16,0	G20679	186,52	G20680	186,52	G20681	235,89
98,0	24,0	16,0	G20693	189,27	G20694	189,27	G20695	238,64
100,6	23,0	16,0	G20704	190,65	G20705	190,65	G20707	240,01
101,6	23,0	16,0	G20757	192,00	G20758	192,00	G20759	241,37
104,0	23,0	16,0	G20806	196,13	G20807	196,13	G20812	245,49
104,8	23,0	16,0	G20829	196,13	G20830	196,13	G20831	245,49
108,0	22,0	16,0	G20863	197,49	G20864	197,49	G20866	246,86
114,3	22,0	16,0	G20913	205,72	G20914	205,72	G20925	250,98

Acoplamiento para tubos metálicos con anclaje axial y con protección al fuego.

Acoplamientos para alta presión de alta calidad.

Continúa en la página siguiente...

J1

diámetro exterior	 PN (bar)	 PN (bar)	CARCASA EN ACERO INOXIDABLE					
			Ref. EPDM	€ EPDM	Ref. NBR	€ NBR	Ref. FKM	€ FKM
118,0	22,0	16,0	G20933	211,23	G20934	211,23	G20935	253,72
125,0	21,0	16,0	G20943	256,47	G20944	256,47	G20945	264,70
127,0	21,0	16,0	G20954	267,43	G20955	267,43	G20958	281,16
129,0	21,0	16,0	G21004	278,39	G21005	278,39	G21007	297,62
130,2	21,0	16,0	G21054	283,90	G21055	283,90	G21056	309,96
133,0	21,0	16,0	G21106	297,62	G21107	297,62	G21113	333,28
139,7	20,0	16,0	G21156	331,89	G21157	331,89	G21169	388,13
141,3	20,0	16,0	G21206	340,11	G21207	340,11	G21209	403,23
144,0	20,0	16,0	G21228	344,25	G21229	344,25	G21230	415,55
154,0	18,0	16,0	G21256	357,94	G21257	357,94	G21264	463,56
159,0	18,0	16,0	G21306	362,08	G21307	362,08	G21312	484,13
165,0	16,0	16,0	G21329	374,41	G21330	374,41	G21332	517,05
168,3	16,0	16,0	G21358	381,27	G21359	381,27	G21377	534,86
219,1	16,0	10,0	21409	704,93	21410	704,93	21418	814,64
180,0	16,0	10,0	24957	979,24	24958	979,24	24960	1.008,03
193,7	16,0	10,0	24997	992,94	25008	992,94	24999	1.023,12
200,0	15,0	10,0	25018	999,81	25019	999,81	25021	1.029,97
204,0	14,0	10,0	25044	1.005,30	25045	1.005,30	25047	1.038,21
206,0	14,0	5,5	25076	1.005,30	25077	1.005,30	25079	1.038,21
244,5	9,0	5,5	25096	1.046,43	25097	1.046,43	25099	1.082,10
250,0	9,0	5,5	25116	1.053,30	25117	1.053,30	25119	1.094,42
254,0	9,0	5,5	25133	1.057,41	25134	1.057,41	25136	1.101,30
256,0	9,0	5,5	25146	1.057,41	25147	1.057,41	25149	1.101,30
267,0	8,0	5,0	25159	1.071,11	25158	1.071,11	25163	1.127,35
273,0	7,0	4,0	25212	1.073,87	25211	1.073,87	25196	1.135,57
306,0	6,0	3,0	25268	1.095,81	25269	1.095,81	25271	1.186,34
323,9	5,0	3,0	25312	1.127,35	25314	1.127,35	25297	1.232,95
355,6	10,0	2,5	25359	1.183,58	25511	1.183,58	25349	1.523,71
406,4	7,0	2,0	25415	1.267,24	25412	1.267,24	25397	1.632,05

Junta: EPDM: -20°C hasta +100°C NBR: -20°C hasta +80°C FKM: -20°C hasta +180°C



Fluido: EPDM: Todas las calidades de agua, aguas residuales, aire, sólidos y diversos productos químicos
 NBR: Agua, gas, aceite, combustible y otros hidrocarburos
 FKM: Ozono, oxígeno, ácidos, gas, aceite y carburantes



GRIP FIRE FENCE

J1

CARCARA EN ACERO GALVANIZADO

diámetro exterior	 PN (bar)	 PN (bar)	Ref. EPDM	€ EPDM	Ref. NBR	€ NBR	Ref. FKM	€ FKM
180,0	16,0	10,0	24956	936,73	24961	936,73	24959	966,88
193,7	16,0	10,0	24995	950,42	24996	950,42	24998	980,62
200,0	15,0	10,0	25016	957,30	25017	957,30	25020	987,45
204,0	14,0	10,0	25042	962,79	25043	962,79	25046	995,68
206,0	14,0	5,5	25073	962,79	25074	962,79	25078	995,68
244,5	9,0	5,5	25094	1.003,92	25095	1.003,92	25098	1.039,58
250,0	9,0	5,5	25108	1.010,78	25109	1.010,78	25118	1.051,92
254,0	9,0	5,5	25123	1.016,26	25124	1.016,26	25135	1.060,15
256,0	9,0	5,5	25138	1.016,26	25139	1.016,26	25148	1.060,15
267,0	8,0	5,0	25160	1.028,60	25161	1.028,60	25162	1.084,85
273,0	7,0	4,0	25193	1.031,36	25194	1.031,36	25195	1.093,07
306,0	6,0	3,0	25266	1.053,30	25267	1.053,30	25270	1.143,82
323,9	5,0	3,0	25294	1.084,85	25295	1.084,85	25296	1.190,44
355,6	10,0	2,5	25346	1.141,05	25347	1.141,05	25348	1.467,46
406,4	7,0	2,0	25394	1.224,74	25395	1.224,74	25396	1.574,45

Acoplamiento para tubos metálicos

con anclaje axial y **con protección al fuego.**

Acoplamientos para alta presión de alta calidad.

Junta: EPDM: -20°C hasta +100°C NBR: -20°C hasta +80°C FKM: -20°C hasta +180°C

Fluido: EPDM: Todas las calidades de agua, aguas residuales, aire, sólidos y diversos productos químicos

NBR: Agua, gas, aceite, combustible y otros hidrocarburos

FKM: Ozono, oxígeno, ácidos, gas, aceite y carburantes



COMBI-GRIP

J1

diámetro exterior	PN (bar)	CARCASA EN ACERO GALVANIZADO				CARCASA EN ACERO INOXIDABLE			
		Ref. EPDM	€ EPDM	Ref. NBR	€ NBR	Ref. EPDM	€ EPDM	Ref. NBR	€ NBR
40,0/38,0	16,0	9130	149,69	9132	149,69	14800	172,96	14801	172,96
40,0/42,4	16,0	9120	149,69	9123	149,69	104274	172,96	14802	172,96
50,0/48,3	16,0	6768	153,63	6769	153,63	100602	177,68	104782	177,68
63,0/60,3	16,0	9114	158,80	9113	158,80	9399	182,39	9400	182,39
75,0/76,1	16,0	94	187,12	98	187,12	100605	216,99	101302	216,99
90,0/88,9	16,0	91	202,83	422	202,83	40458	231,15	420	231,15
110,0/108,0	16,0	424	226,42	426	226,42	101504	256,29	104793	256,29
110,0/114,3	16,0	14954	286,17	14956	286,17	100606	322,36	101041	322,36
114,3/114,3	16,0	428	237,44	430	237,44	442	267,31	443	267,31
140,0/139,7	16,0	432	367,93	434	367,93	40500	415,12	40501	415,12
160,0/159,0	16,0	436	408,83	438	408,83	40502	456,01	40503	456,01
160,0/168,3	16,0					102727	456,01	102726	456,01
200,0/206,0	16,0	102704	531,47	102705	531,47	101839	581,80	102196	581,80
225,0/219,1	10,0	102707	561,35	102708	561,35	102706	613,22	102709	613,22
225,0/229,0	10,0	102881	561,35	102880	561,35	102035	613,22	102879	613,22
250,0/256,0	10,0	102715	594,37	102713	594,37	102225	644,68	102712	644,68
315,0/323,9	10,0	102714	679,29	102716	679,29	102569	729,62	102717	729,62
355,0/355,6	6,0	102721	732,75	102720	732,75	102719	783,08	102718	783,08

Acoplamiento para transiciones de tubos plásticos a metálicos con anclaje axial.
En tubos plásticos es necesario incorporar el anillo de refuerzo "stiffening ring"

Junta: EPDM: -20°C hasta +100°C NBR: -20°C hasta +80°C
Fluido: EPDM: Todas las calidades de agua, aguas residuales, aire, sólidos y diversos productos químicos
NBR: Agua, gas, aceite, combustible y otros hidrocarburos



PLAST-GRIP

J1

diámetro exterior	PN (bar)	CARCASA EN ACERO GALVANIZADO				CARCASA EN ACERO INOXIDABLE			
		Ref. EPDM	€ EPDM	Ref. NBR	€ NBR	Ref. EPDM	€ EPDM	Ref. NBR	€ NBR
40,0	16,0	6760	149,69	6761	149,69	40300	172,96	43001	172,96
50,0	16,0	6758	153,63	6749	153,63	6757	177,68	43002	177,68
63,0	16,0	87	158,80	89	158,80	9397	182,39	9398	182,39
75,0	16,0	337	187,12	344	187,12	43150	216,99	43151	216,99
90,0	16,0	338	202,83	345	202,83	100266	231,15	368	231,15
110,0	16,0	339	226,42	346	226,42	367	256,29	369	256,29
114,3	16,0	340	237,44	347	237,44	43152	267,31	43153	267,31
125,0	16,0	341	323,91	348	323,91	41210	371,09	41211	371,09
140,0	16,0	342	367,93	349	367,93	40220	415,11	40221	415,11
160,0	16,0	343	408,83	350	408,83	40240	456,01	40241	456,01
180,0	16,0	225	501,61	226	501,61	227	553,48	228	553,48
200,0	16,0	229	531,47	230	531,47	231	581,80	232	581,80
225,0	10,0	233	561,35	234	561,35	235	613,22	236	613,22
250,0	10,0	237	594,37	238	594,37	239	644,68	240	644,68
280,0	10,0	245	633,68	101140	633,68	244	684,00	101139	684,00
315,0	10,0	101147	679,29	101148	679,29	101146	729,62	101145	729,62
355,0	6,0	101152	732,75	101151	732,75	101149	783,08	101150	783,08

Acoplamiento para tubos plásticos con anclaje axial.

En tubos plásticos es necesario incorporar el anillo de refuerzo "stiffening ring"

Junta: EPDM: -20°C hasta +100°C

NBR: -20°C hasta +80°C

Fluido: EPDM: Todas las calidades de agua, aguas residuales, aire, sólidos y diversos productos químicos

NBR: Agua, gas, aceite, combustible y otros hidrocarburos



FLEX 1

J1

diámetro exterior	PN (bar)	PN (bar)	CARCASA EN ACERO GALVANIZADO					
			Ref. EPDM	€ EPDM	Ref. NBR	€ NBR	Ref. FKM (1)	€ FKM
48,3	25,0	16,0	30001	64,48	30003	64,48		
54,0	25,0	16,0	30051	66,04	30053	66,04		
57,0	25,0	16,0	30101	66,68	30103	66,68		
60,3	25,0	16,0	30151	68,25	30153	68,25	30162	129,58
70,0	25,0	16,0	30194	77,37	30191	77,37	30196	150,49
73,0	25,0	16,0	30201	78,00	30203	78,00	30208	152,23
76,1	25,0	16,0	30251	78,60	30253	78,60	30258	153,95
80,0	25,0	16,0	102949	79,57	102950	79,57	102951	155,83
84,0	25,0	16,0	30301	80,34	30303	80,34	30314	157,09
88,9	25,0	16,0	30351	81,45	30353	81,45	30364	158,80
100,6	25,0	16,0	30401	83,81	30403	83,81	30411	161,96
101,6	25,0	16,0	30451	83,96	30453	83,96	30460	161,96
104,0	20,0	16,0	30501	84,28	30503	84,28	30511	163,53
104,8	20,0	16,0	30551	84,61	30553	84,61	30559	163,53
108,0	20,0	16,0	30601	85,21	30603	85,21	30613	165,11
114,3	20,0	16,0	30651	86,01	30653	86,01	30658	165,11
127,0	20,0	16,0	30676	112,28	30678	112,28	30679	198,14
129,0	20,0	16,0	30701	113,22	30703	113,22	30715	199,69
130,2	20,0	16,0	30751	113,67	30753	113,67	30754	201,28
133,0	16,0	16,0	30801	115,10	30803	115,10	30812	202,83
139,7	16,0	16,0	30851	116,82	30853	116,82	30867	210,71
141,3	16,0	16,0	30901	117,61	30903	117,61	30909	212,27
154,0	16,0	16,0	30951	120,77	30953	120,77	30963	226,42
159,0	16,0	16,0	31001	122,63	31003	122,63	31016	231,15
168,3	16,0	16,0	31051	125,64	31053	125,64	31075	240,58

Acoplamiento para tubos de cualquier material sin anclaje axial.

Acoplamiento de unión y compensador todo en uno.

(1) acoplamiento con anillo interior en acero inoxidable incorporado

Junta: EPDM: -20°C hasta +100°C NBR: -20°C hasta +80°C FKM: -20°C hasta +180°C

Fluido: EPDM: Todas las calidades de agua, aguas residuales, aire, sólidos y diversos productos químicos

NBR: Agua, gas, aceite, combustible y otros hidrocarburos

FKM: Ozono, oxígeno, ácidos, gas, aceite y carburantes



FLEX 1

J1

diámetro exterior	PN (bar)		Ref. EPDM	€		CARCASA EN ACERO INOXIDABLE		Ref. FKM (1)	€	
	PN (bar)	PN (bar)		EPDM	EPDM	Ref. NBR	NBR		FKM (1)	FKM
48,3	25,0	16,0	30000	89,15	30002	89,15				
54,0	25,0	16,0	30050	91,21	30052	91,21				
57,0	25,0	16,0	30100	91,97	30102	91,97				
60,3	25,0	16,0	30150	92,93	30152	92,93	30166	153,95		
70,0	25,0	16,0	30193	102,68	30195	102,68	30197	176,10		
73,0	25,0	16,0	30200	103,16	30202	103,16	30216	177,68		
76,1	25,0	16,0	30250	103,63	30252	103,63	30266	179,24		
80,0	25,0	16,0	30318	104,88	100222	104,88	102948	180,84		
84,0	24,0	16,0	30300	105,67	30302	105,67	30315	182,39		
88,9	24,0	16,0	30350	106,61	30352	106,61	30366	183,98		
100,6	23,0	16,0	30400	108,98	30402	108,98	30412	187,12		
101,6	23,0	16,0	30450	109,12	30452	109,12	30461	187,12		
104,0	22,0	16,0	30500	109,45	30502	109,45	30512	190,25		
104,8	22,0	16,0	30550	109,59	30552	109,59	30560	190,25		
108,0	22,0	16,0	30600	110,86	30602	110,86	30614	191,85		
114,3	21,0	16,0	30650	111,65	30652	111,65	30666	191,85		
127,0	19,0	16,0	30675	144,49	30677	144,49	30680	229,56		
129,0	18,0	16,0	30700	145,43	30702	145,43	30716	231,15		
130,2	18,0	16,0	30750	146,08	30752	146,08	30755	232,71		
133,0	16,0	16,0	30800	147,02	30802	147,02	30813	234,30		
139,7	16,0	16,0	30850	149,37	30852	149,37	30866	243,71		
141,3	16,0	16,0	30900	149,69	30902	149,69	30908	245,31		
154,0	16,0	16,0	30950	153,46	30952	153,46	30964	259,44		
159,0	16,0	16,0	31000	155,19	31002	155,19	31017	264,17		
168,3	16,0	16,0	31050	158,80	31052	158,80	31074	273,60		

Acoplamiento para tubos de cualquier material sin anclaje axial.

Acoplamiento de unión y compensador todo en uno.

(1) acoplamiento con anillo interior en acero inoxidable incorporado

Junta: EPDM: -20°C hasta +100°C NBR: -20°C hasta +80°C FKM: -20°C hasta +180°C

Fluido: EPDM: Todas las calidades de agua, aguas residuales, aire, sólidos y diversos productos químicos
 NBR: Agua, gas, aceite, combustible y otros hidrocarburos
 FKM: Ozono, oxígeno, ácidos, gas, aceite y carburantes



FLEX 2 PN 2,5

PN Consultar

J1

desde Ø exterior	hasta Ø exterior	Ref. EPDM	W1 CARCASA GALVANIZADA. CIERRES GALVANIZADOS			W2 CARCASA EN ACERO INOX. CIERRES GALVANIZADOS			W5 CARCASA EN ACERO INOX. CIERRES EN ACERO INOX.		
			€ EPDM	€ NBR	€ FKM (1)	€ EPDM	€ NBR	€ FKM (1)	€ EPDM	€ NBR	€ FKM (1)
172,0	199,0					321,50	321,50	472,69	382,74	382,74	533,92
200,0	224,0					331,08	331,08	507,12	392,32	392,32	568,36
225,0	249,0					338,73	338,73	545,40	399,97	399,97	606,64
250,0	274,0					350,21	350,21	585,60	411,45	411,45	646,83

Continúa en la página siguiente...

desde Ø exterior	hasta Ø exterior	Ref. EPDM	W1 CARCASA GALVANIZADA. CIERRES GALVANIZADOS			W2 CARCASA EN ACERO INOX. CIERRES GALVANIZADOS			W5 CARCASA EN ACERO INOX. CIERRES EN ACERO INOX.		
			€ EPDM	€ NBR	€ FKM (1)	€ EPDM	€ NBR	€ FKM (1)	€ EPDM	€ NBR	€ FKM (1)
275,0	299,0	F2020275W1E	581,76	581,77	822,89	355,94	355,94	625,77	417,18	417,18	687,01
300,0	324,0	F2020300W1E	591,34	591,34	864,98	369,33	369,33	662,13	430,57	430,57	723,36
325,0	349,0	F2020325W1E	600,89	600,89	910,91	376,99	376,99	702,31	438,23	438,23	763,56
350,0	374,0	F2020350W1E	610,47	610,47	949,19	386,57	386,57	740,60	447,81	447,81	801,84
375,0	399,0	F2020375W1E	620,05	620,05	995,12	394,23	394,23	778,85	455,46	455,46	840,09
400,0	424,0	F2020400W1E	633,43	633,43	1.041,04	401,86	401,86	817,14	463,10	463,10	878,38
425,0	449,0	F2020425W1E	643,00	643,00	1.077,40	413,35	413,35	857,33	474,59	474,59	918,56
450,0	474,0	F2020450W1E	652,58	652,58	1.117,59	424,86	424,86	897,51	486,07	486,07	958,75
475,0	499,0	F2020475W1E	664,06	664,06	1.157,76	438,23	438,23	933,88	499,47	499,47	995,12
500,0	524,0	F2020500W1E	671,71	671,70	1.196,05	449,70	449,70	974,05	510,94	510,94	1.035,29
525,0	549,0	F2020525W1E	687,01	687,01	1.240,07	461,21	461,21	1.012,34	522,45	522,45	1.073,58
550,0	574,0	F2020550W1E	706,14	706,14	1.289,83	470,76	470,76	1.052,52	531,99	531,99	1.113,76
575,0	599,0	F2020575W1E	721,46	721,47	1.331,91	484,16	484,16	1.090,81	545,40	545,40	1.152,05
600,0	624,0	F2020600W1E	763,56	763,56	1.374,03	570,28	570,28	1.184,58	631,52	631,52	1.245,81
625,0	649,0	F2020625W1E	778,85	778,85	1.425,69	576,01	576,01	1.226,66	637,26	637,26	1.287,90
650,0	674,0	F2020650W1E	794,19	794,19	1.467,79	589,41	589,41	1.264,95	650,66	650,66	1.326,18
675,0	699,0	F2020675W1E	809,49	809,49	1.509,91	604,72	604,72	1.305,13	665,96	665,96	1.366,37
700,0	724,0	F2020700W1E	828,63	828,63	1.555,82	618,12	618,12	1.343,42	679,36	679,36	1.404,66
725,0	749,0	F2020725W1E	843,92	843,92	1.596,03	637,26	637,26	1.383,60	698,49	698,49	1.444,84
750,0	799,0	F2020750W1E	857,33	857,33	1.618,98	753,99	753,99	1.444,84	815,24	815,24	1.506,08
800,0	849,0	F2020800W1E	891,79	891,78	1.661,09	780,78	780,78	1.523,28	842,03	842,03	1.584,52
850,0	899,0	F2020850W1E	920,49	920,49	1.703,18	807,56	807,56	1.601,75	868,81	868,81	1.662,99
900,0	949,0	F2020900W1E	954,93	954,93	1.789,29	838,20	838,20	1.684,04	899,44	899,44	1.745,28
950,0	999,0	F2020950W1E	985,56	985,56	1.879,24	864,98	864,98	1.762,51	926,22	926,22	1.823,75
1.000,0	1.049,0	F2021000W1E	1.014,26	1.014,26	1.961,53	895,61	895,61	1.840,95	956,85	956,85	1.902,19
1.050,0	1.099,0	F2021050W1E	1.050,62	1.050,63	2.039,98	931,97	931,97	1.919,43	993,21	993,21	1.980,66
1.100,0	1.149,0	F2021100W1E	1.079,32	1.079,32	2.108,88	972,15	972,15	1.999,80	1.033,40	1.033,40	2.061,03
1.150,0	1.199,0	F2021150W1E	1.111,86	1.111,86	2.183,51	1.010,43	1.010,43	2.080,16	1.071,65	1.071,65	2.141,39
1.200,0	1.249,0	F2021200W1E	1.144,39	1.144,39	2.260,06	1.048,70	1.048,70	2.158,63	1.109,93	1.109,93	2.219,87
1.250,0	1.299,0	F2021250W1E	1.178,83	1.178,83	2.338,52	1.086,98	1.086,98	2.239,00	1.148,22	1.148,22	2.300,25
1.300,0	1.349,0	F2021300W1E	1.211,37	1.211,37	2.415,06	1.123,34	1.123,34	2.317,47	1.184,58	1.184,58	2.378,71
1.350,0	1.399,0	F2021350W1E	1.245,81	1.245,81	2.491,62	1.161,59	1.161,59	2.395,94	1.222,83	1.222,83	2.457,18
1.400,0	1.449,0	F2021400W1E	1.278,35	1.278,35	2.570,08	1.197,95	1.197,95	2.476,30	1.259,19	1.259,19	2.537,54
1.450,0	1.499,0	F2021450W1E	1.312,79	1.312,79	2.646,62	1.236,24	1.236,24	2.556,67	1.297,47	1.297,47	2.617,92
1.500,0	1.549,0	F2021500W1E	1.345,31	1.345,32	2.723,16	1.624,71	1.624,71	3.002,58	1.689,77	1.689,77	3.067,65
1.550,0	1.600,0	F2021550W1E	1.379,78	1.379,77	2.801,63	1.670,64	1.670,64	3.092,53	1.735,70	1.735,70	3.157,59
1.600,0	1.649,0	F2021600W1E	1.414,20	1.414,20	2.878,17	1.718,48	1.718,48	3.182,45	1.783,55	1.783,55	3.247,52
1.650,0	1.699,0	F2021650W1E	1.446,74	1.446,74	2.954,72	1.766,34	1.766,34	3.274,32	1.831,41	1.831,41	3.339,39
1.700,0	1.749,0	F2021700W1E	1.481,20	1.481,20	3.031,29	1.814,17	1.814,17	3.364,26	1.879,24	1.879,24	3.429,32
1.750,0	1.799,0	F2021750W1E	1.513,73	1.513,72	3.107,83	1.860,12	1.860,12	3.456,11	1.925,19	1.925,19	3.521,18
1.800,0	1.849,0	F2021800W1E	1.548,16	1.548,16	3.184,37	1.907,95	1.907,95	3.546,05	1.973,02	1.973,02	3.611,12
1.850,0	1.899,0	F2021850W1E	1.580,69	1.580,69	3.262,83	1.955,78	1.955,78	3.636,01	2.020,85	2.020,85	3.701,07
1.900,0	1.949,0	F2021900W1E	1.615,15	1.615,15	3.339,39	2.001,72	2.001,72	3.727,85	2.066,78	2.066,78	3.792,92
1.950,0	1.999,0	F2021950W1E	1.647,69	1.647,69	3.415,93	2.049,56	2.049,56	3.817,80	2.114,61	2.114,61	3.882,87
2.000,0	2.032,0	F2022000W1E	1.682,12	1.682,12	3.492,47	2.097,39	2.097,39	3.907,74	2.162,46	2.162,46	3.972,80

Acoplamiento para tubos de cualquier material sin anclaje axial.

Acoplamiento de unión y compensador todo en uno.

Código W1 en NBR termina W1N
Código W1 en FKM termina W1F

Código W2 en EPDM termina W2E
Código W2 en NBR termina W2N
Código W2 en FKM termina W2F

Código W5 en EPDM termina W5E
Código W5 en NBR termina W5N
Código W5 en FKM termina W5F

(1) Los acoplamientos con la junta en FKM llevan incluido un anillo interior en acero inoxidable

En caso de pedido indicar el diámetro exterior exacto

Junta: EPDM: -20°C hasta +100°C NBR: -20°C hasta +80°C FKM: -20°C hasta +180°C

Fluido: EPDM: Todas las calidades de agua, aguas residuales, aire, sólidos y diversos productos químicos

NBR: Agua, gas, aceite, combustible y otros hidrocarburos

FKM: Ozono, oxígeno, ácidos, gas, aceite y carburantes

Especificación 1 o 2 cierres

FLEX 2 PN 6

 PN  Consultar

J1

desde Ø exterior	hasta Ø exterior	Ref. EPDM	W1 CARCASA GALVANIZADA. CIERRES GALVANIZADOS			W2 CARCASA EN ACERO INOX. CIERRES GALVANIZADOS			W5 CARCASA EN ACERO INOX. CIERRES EN ACERO INOX.		
			€ EPDM	€ NBR	€ FKM (1)	€ EPDM	€ NBR	€ FKM (1)	€ EPDM	€ NBR	€ FKM (1)
172,0	199,0					321,50	321,50	472,69	382,74	382,74	533,92
200,0	224,0					331,08	331,08	507,12	392,32	392,32	568,36
225,0	249,0					338,73	338,73	545,40	399,97	399,97	606,64
250,0	274,0					350,21	350,21	585,60	411,45	411,45	646,83
275,0	299,0	F2060275W1E	581,76	581,77	822,89	355,94	355,94	625,77	417,18	417,18	687,01
300,0	324,0	F2060300W1E	591,34	591,34	864,98	369,33	369,33	662,13	430,57	430,57	723,36
325,0	349,0	F2060325W1E	600,89	600,89	910,91	376,99	376,99	702,31	438,23	438,23	763,56
350,0	374,0	F2060350W1E	610,47	610,47	949,19	386,57	386,57	740,60	447,81	447,81	801,84
375,0	399,0	F2060375W1E	620,05	620,05	995,12	394,23	394,23	778,85	455,46	455,46	840,09
400,0	424,0	F2060400W1E	633,43	633,43	1.041,04	401,86	401,86	817,14	463,10	463,10	878,38
425,0	449,0	F2060425W1E	643,00	643,00	1.077,40	413,35	413,35	857,33	474,59	474,59	918,56
450,0	474,0	F2060450W1E	652,58	652,58	1.117,59	424,86	424,86	897,51	486,07	486,07	958,75
475,0	499,0	F2060475W1E	664,06	664,06	1.157,76	438,23	438,23	933,88	499,47	499,47	995,12
500,0	524,0	F2060500W1E	671,71	671,70	1.196,05	449,70	449,70	974,05	510,94	510,94	1.035,29
525,0	549,0	F2060525W1E	687,01	687,01	1.240,07	507,12	507,12	1.065,93	568,36	568,36	1.127,17
550,0	574,0	F2060550W1E	706,14	706,14	1.289,83	518,60	518,60	1.106,10	579,84	579,84	1.167,34
575,0	599,0	F2060575W1E	721,46	721,47	1.331,91	531,99	531,99	1.144,39	593,23	593,23	1.205,63
600,0	624,0	F2060600W1E	763,56	763,56	1.374,03	727,19	727,19	1.337,67	792,26	792,26	1.402,74
625,0	649,0	F2060625W1E	778,85	778,85	1.425,69	736,77	736,77	1.383,60	801,84	801,84	1.448,67
650,0	674,0	F2060650W1E	794,19	794,19	1.467,79	753,99	753,99	1.429,52	819,06	819,06	1.494,58
675,0	699,0	F2060675W1E	809,49	809,49	1.509,91	775,02	775,02	1.473,55	840,09	840,09	1.538,62
700,0	724,0	F2060700W1E	828,63	828,63	1.555,82	792,26	792,26	1.519,45	857,33	857,33	1.584,52
725,0	749,0	F2060725W1E	843,92	843,92	1.596,03	813,31	813,31	1.567,32	878,38	878,38	1.632,38
750,0	799,0	F2060750W1E	857,33	857,33	1.618,98	966,39	966,39	1.636,21	1.031,46	1.031,46	1.701,28
800,0	849,0	F2060800W1E	891,79	891,78	1.661,09	998,93	998,93	1.726,16	1.064,00	1.064,00	1.791,22

Acoplamiento para tubos de cualquier material sin anclaje axial.

Acoplamiento de unión y compensador todo en uno.

 Código W1 en NBR termina W1N
 Código W1 en FKM termina W1F

 Código W2 en EPDM termina W2E
 Código W2 en NBR termina W2N
 Código W2 en FKM termina W2F

 Código W5 en EPDM termina W5E
 Código W5 en NBR termina W5N
 Código W5 en FKM termina W5F

Continúa en la página siguiente...

J1

desde Ø exterior	hasta Ø exterior	Ref. EPDM	W1 CARCASA GALVANIZADA. CIERRES GALVANIZADOS			W2 CARCASA EN ACERO INOX. CIERRES GALVANIZADOS			W5 CARCASA EN ACERO INOX. CIERRES EN ACERO INOX.		
			€ EPDM	€ NBR	€ FKM (1)	€ EPDM	€ NBR	€ FKM (1)	€ EPDM	€ NBR	€ FKM (1)
850,0	899,0	F2060850W1E	920,49	920,49	1.703,18	1035,29	1.035,29	1.818,00	1.100,36	1.100,36	1.883,07
900,0	949,0	F2060900W1E	954,93	954,93	1.789,29	1071,65	1.071,65	1.907,95	1.136,71	1.136,71	1.973,02
950,0	999,0	F2060950W1E	985,56	985,56	1.879,24	1108,03	1.108,03	1.999,80	1.173,10	1.173,10	2.064,86
1.000,0	1.049,0	F2061000W1E	1.014,26	1.014,26	1.961,53	1144,39	1.144,39	2.091,66	1.209,46	1.209,46	2.156,73
1.050,0	1.099,0	F2061050W1E	1.050,62	1.050,63	2.039,98	1192,23	1.192,23	2.181,62	1.257,30	1.257,30	2.246,68
1.100,0	1.149,0	F2061100W1E	1.079,32	1.079,32	2.108,88	1243,89	1.243,89	2.273,47	1.308,96	1.308,96	2.338,52
1.150,0	1.199,0	F2061150W1E	1.111,86	1.111,86	2.183,51	1293,65	1.293,65	2.365,30	1.358,71	1.358,71	2.430,37
1.200,0	1.249,0	F2061200W1E	1.144,39	1.144,39	2.260,06				2.259,92	2.259,92	4.376,73
1.250,0	1.299,0	F2061250W1E	1.178,83	1.178,83	2.338,52				2.318,48	2.318,48	4.509,02
1.300,0	1.349,0	F2061300W1E	1.211,37	1.211,37	2.415,06				2.379,23	2.379,23	4.641,31
1.350,0	1.399,0	F2061350W1E	1.245,81	1.245,81	2.491,62				2.442,10	2.442,10	4.775,80
1.400,0	1.449,0	F2061400W1E	1.278,35	1.278,35	2.570,08				2.505,01	2.505,01	4.912,42
1.450,0	1.499,0	F2061450W1E	1.312,79	1.312,79	2.646,62				2.572,24	2.572,24	5.051,22
1.500,0	1.549,0	F2061500W1E	1.345,31	1.345,32	2.723,16				2.637,30	2.637,30	5.192,21
1.550,0	1.600,0	F2061550W1E	1.379,78	1.379,77	2.801,63				2.706,72	2.706,72	5.333,19
1.600,0	1.649,0	F2061600W1E	1.414,20	1.414,20	2.878,17				2.776,12	2.776,12	5.478,50
1.650,0	1.699,0	F2061650W1E	1.446,74	1.446,74	2.954,72				2.849,86	2.849,86	5.623,79
1.700,0	1.749,0	F2061700W1E	1.481,20	1.481,20	3.031,29				2.923,58	2.923,58	5.769,12
1.750,0	1.799,0	F2061750W1E	1.513,73	1.513,72	3.107,83				3.001,67	3.001,67	5.920,94
1.800,0	1.849,0	F2061800W1E	1.548,16	1.548,16	3.184,37				3.270,62	3.270,62	6.261,43
1.850,0	1.899,0	F2061850W1E	1.580,69	1.580,69	3.262,83				3.357,36	3.357,36	6.419,78
1.900,0	1.949,0	F2061900W1E	2.321,30	2.321,30	4.047,46				3.446,30	3.446,30	6.582,44
1.950,0	1.999,0	F2061950W1E	2.369,13	2.369,13	4.137,39				3.539,56	3.539,56	6.749,43
2.000,0	2.032,0	F2062000W1E	2.417,00	2.416,99	4.227,32				3.632,80	3.632,80	6.914,28

 Código W1 en NBR termina W1N
 Código W1 en FKM termina W1F

 Código W2 en EPDM termina W2E
 Código W2 en NBR termina W2N
 Código W2 en FKM termina W2F

 Código W5 en EPDM termina W5E
 Código W5 en NBR termina W5N
 Código W5 en FKM termina W5F

(1) Los acoplamientos con la junta en FKM llevan incluido un anillo interior en acero inoxidable

En caso de pedido indicar el diámetro exterior exacto

Junta: EPDM: -20°C hasta +100°C NBR: -20°C hasta +80°C FKM: -20°C hasta +180°C

Fluido: EPDM: Todas las calidades de agua, aguas residuales, aire, sólidos y diversos productos químicos

NBR: Agua, gas, aceite, combustible y otros hidrocarburos

FKM: Ozono, oxígeno, ácidos, gas, aceite y carburantes

Especificar 1 o 2 cierres

FLEX 2 PN 10

J1

desde Ø exterior	hasta Ø exterior	Ref. EPDM	W1 CARCASA GALVANIZADA. CIERRES GALVANIZADOS			W2 CARCASA EN ACERO INOX. CIERRES GALVANIZADOS			W5 CARCASA EN ACERO INOX. CIERRES EN ACERO INOX.		
			€ EPDM	€ NBR	€ FKM (1)	€ EPDM	€ NBR	€ FKM (1)	€ EPDM	€ NBR	€ FKM (1)
172,0	199,0					321,50	321,50	472,69	382,74	382,74	533,92
200,0	224,0					331,08	331,08	507,12	392,32	392,32	568,36
225,0	249,0					338,73	338,73	545,40	399,97	399,97	606,64
250,0	274,0					350,21	350,21	585,60	411,45	411,45	646,83
275,0	299,0	F2100275W1E	581,76	581,77	822,89	394,23	394,23	669,78	455,46	455,46	731,02
300,0	324,0	F2100300W1E	591,34	591,34	864,98	403,79	403,79	709,97	465,03	465,03	771,21
325,0	349,0	F2100325W1E	600,89	600,89	910,91	413,35	413,35	748,25	474,59	474,59	809,49
350,0	374,0	F2100350W1E	610,47	610,47	949,19	543,48	543,48	882,21	608,55	608,55	947,27
375,0	399,0	F2100375W1E	620,05	620,05	995,12	553,06	553,06	928,14	618,12	618,12	993,21
400,0	424,0	F2100400W1E	633,43	633,43	1.041,04	566,45	566,45	974,05	631,52	631,52	1.039,12
425,0	449,0	F2100425W1E	643,00	643,00	1.077,40	583,65	583,65	1.020,00	648,72	648,72	1.085,05
450,0	474,0	F2100450W1E	652,58	652,58	1.117,59	598,99	598,99	1.064,00	664,06	664,06	1.129,07
475,0	499,0	F2100475W1E	664,06	664,06	1.157,76	616,19	616,19	1.109,93	681,26	681,26	1.175,00
500,0	524,0	F2100500W1E	671,71	671,70	1.196,05	631,52	631,52	1.155,88	696,58	696,58	1.220,94
525,0	549,0	F2100525W1E	687,01	687,01	1.240,07	650,66	650,66	1.201,78	715,72	715,72	1.266,84
550,0	574,0	F2100550W1E	706,14	706,14	1.289,83	664,06	664,06	1.247,72	729,12	729,12	1.312,79
575,0	599,0	F2100575W1E	721,46	721,47	1.331,91	681,26	681,26	1.293,65	746,33	746,33	1.358,71
600,0	624,0	F2100600W1E	763,56	763,56	1.374,03	727,19	727,19	1.337,67	792,26	792,26	1.402,74
625,0	649,0	F2100625W1E	778,85	778,85	1.425,69	736,77	736,77	1.383,60	801,84	801,84	1.448,67
650,0	674,0	F2100650W1E	794,19	794,19	1.467,79	753,99	753,99	1.429,52	819,06	819,06	1.494,58
675,0	699,0	F2100675W1E	809,49	809,49	1.509,91	775,02	775,02	1.473,55	840,09	840,09	1.538,62
700,0	724,0	F2100700W1E	828,63	828,63	1.555,82	792,26	792,26	1.519,45	857,33	857,33	1.584,52
725,0	749,0	F2100725W1E	843,92	843,92	1.596,03				1.748,09	1.748,09	3.136,14
750,0	799,0	F2100750W1E	857,33	857,33	1.618,98				1.774,12	1.774,12	3.235,90
800,0	849,0	F2100800W1E	891,79	891,78	1.661,09				1.804,47	1.804,47	3.340,01

Acoplamiento para tubos de cualquier material sin anclaje axial.

Acoplamiento de unión y compensador todo en uno.

Código W1 en NBR termina W1N
Código W1 en FKM termina W1F

Código W2 en EPDM termina W2E
Código W2 en NBR termina W2N
Código W2 en FKM termina W2F

Código W5 en EPDM termina W5E
Código W5 en NBR termina W5N
Código W5 en FKM termina W5F

Continúa en la página siguiente...

J1

desde Ø exterior	hasta Ø exterior	Ref. EPDM	W1 CARCASA GALVANIZADA. CIERRES GALVANIZADOS			W2 CARCASA EN ACERO INOX. CIERRES GALVANIZADOS			W5 CARCASA EN ACERO INOX. CIERRES EN ACERO INOX.		
			€ EPDM	€ NBR	€ FKM (1)	€ EPDM	€ NBR	€ FKM (1)	€ EPDM	€ NBR	€ FKM (1)
850,0	899,0	F2100850W1E	920,49	920,49	1.703,18				1.834,83	1.834,83	3.439,79
900,0	949,0	F2100900W1E	954,93	954,93	1.789,29				1.986,65	1.986,65	3.665,34
950,0	999,0	F2100950W1E	985,56	985,56	1.879,24				2.014,86	2.014,86	3.767,27
1.000,0	1.049,0	F2101000W1E	1.471,62	1.471,62	2.418,89				2.040,90	2.040,90	3.867,04
1.050,0	1.099,0	F2101050W1E	1.523,28	1.523,28	2.512,67				2.075,59	2.075,59	3.971,13
1.100,0	1.149,0	F2101100W1E	1.567,32	1.567,32	2.596,86				2.166,68	2.166,68	4.140,31
1.150,0	1.199,0	F2101150W1E	1.613,23	1.613,23	2.684,91				2.207,88	2.207,88	4.250,91
1.200,0	1.249,0	F2101200W1E	1.659,16	1.659,16	2.774,85						
1.250,0	1.299,0	F2101250W1E	1.706,99	1.706,99	2.866,70						
1.300,0	1.349,0	F2101300W1E	1.754,84	1.754,84	2.956,65						
1.350,0	1.399,0	F2101350W1E	1.800,77	1.800,77	3.046,58						
1.400,0	1.449,0	F2101400W1E	1.848,61	1.848,61	3.140,36						
1.450,0	1.499,0	F2101450W1E	1.896,47	1.896,46	3.230,32						
1.500,0	1.549,0	F2101500W1E	1.944,30	1.944,31	3.322,15						
1.550,0	1.600,0	F2101550W1E	1.990,26	1.990,25	3.412,10						
1.600,0	1.649,0	F2101600W1E	2.038,08	2.038,08	3.502,05						
1.650,0	1.699,0	F2101650W1E	2.085,91	2.085,92	3.593,89						
1.700,0	1.749,0	F2101700W1E	2.131,84	2.131,85	3.683,84						
1.750,0	1.799,0	F2101750W1E	2.179,68	2.179,68	3.773,79						
1.800,0	1.849,0	F2101800W1E	2.227,52	2.227,52	3.865,63						
1.850,0	1.899,0	F2101850W1E	2.275,35	2.275,35	3.955,57						
1.900,0	1.949,0	F2101900W1E	2.321,30	2.321,30	4.047,46						
1.950,0	1.999,0	F2101950W1E	2.369,13	2.369,13	4.137,39						
2.000,0	2.032,0	F2102000W1E	2.417,00	2.416,99	4.227,32						

Código W1 en NBR termina W1N
Código W1 en FKM termina W1F

Código W5 en EPDM termina W5E
Código W5 en NBR termina W5N
Código W5 en FKM termina W5F

(1) Los acoplamientos con la junta en FKM llevan incluido un anillo interior en acero inoxidable

En caso de pedido indicar el diámetro exterior exacto

Junta: EPDM: -20°C hasta +100°C NBR: -20°C hasta +80°C FKM: -20°C hasta +180°C

Fluido: EPDM: Todas las calidades de agua, aguas residuales, aire, sólidos y diversos productos químicos

NBR: Agua, gas, aceite, combustible y otros hidrocarburos

FKM: Ozono, oxígeno, ácidos, gas, aceite y carburantes

Especificar 1 o 2 cierres



FLEX 2 PN 16 PN Consultar

J1

desde Ø exterior	hasta Ø exterior	Ref. EPDM	W1 CARCASA GALVANIZADA. CIERRES GALVANIZADOS			W2 CARCASA EN ACERO INOX. CIERRES GALVANIZADOS			W5 CARCASA EN ACERO INOX. CIERRES EN ACERO INOX.		
			EPDM	€	€	€	€	€	€	€	€
			EPDM	NBR	FKM (1)	EPDM	NBR	FKM (1)	EPDM	NBR	FKM (1)
172,0	199,0					525,12	519,92	514,77	413,35	413,35	576,01
200,0	224,0					560,27	554,72	549,23	426,75	426,75	610,47
225,0	249,0					667,62	661,01	654,47	543,48	543,48	719,54
250,0	274,0					714,49	707,42	700,41	558,82	558,82	765,48
275,0	299,0	F2160275W1E	581,76	581,77	822,89	759,39	751,87	744,43	570,28	570,28	809,49
300,0	324,0	F2160300W1E	591,34	591,34	864,98	808,18	800,18	792,26	583,65	583,65	857,33
325,0	349,0	F2160325W1E	600,89	600,89	910,91	855,05	846,59	838,20	593,23	593,23	903,27
350,0	374,0	F2160350W1E	610,47	610,47	949,19	899,94	891,03	882,21	608,55	608,55	947,27
375,0	399,0	F2160375W1E	620,05	620,05	995,12	946,80	937,42	928,14	618,12	618,12	993,21
400,0	424,0	F2160400W1E	633,43	633,43	1.041,04	993,63	983,79	974,05	631,52	631,52	1.039,12
425,0	449,0	F2160425W1E	643,00	643,00	1.077,40				1.511,67	1.511,67	2.463,81
450,0	474,0	F2160450W1E	652,58	652,58	1.117,59				1.529,04	1.529,04	2.515,86
475,0	499,0	F2160475W1E	664,06	664,06	1.157,76				1.542,04	1.542,04	2.563,57
500,0	524,0	F2160500W1E	671,71	671,70	1.196,05				1.555,06	1.555,06	2.615,63
525,0	549,0	F2160525W1E	687,01	687,01	1.240,07				1.568,08	1.568,08	2.665,51
550,0	574,0	F2160550W1E	706,14	706,14	1.289,83				1.581,08	1.581,08	2.713,22
575,0	599,0	F2160575W1E	721,46	721,47	1.331,91				1.594,11	1.594,11	2.765,28
600,0	624,0	F2160600W1E	763,56	763,56	1.374,03				1.641,81	1.641,81	2.847,70
625,0	649,0	F2160625W1E	1.129,06	1.129,07	1.775,89				1.654,82	1.654,82	2.899,76
650,0	674,0	F2160650W1E	1.153,95	1.153,95	1.827,58				1.670,01	1.670,01	2.951,80
675,0	699,0	F2160675W1E	1.175,00	1.175,00	1.875,41				1.687,35	1.687,35	3.001,67
700,0	724,0	F2160700W1E	1.197,95	1.197,95	1.925,19				1.732,90	1.732,90	3.084,10
725,0	749,0	F2160725W1E	1.222,83	1.222,83	1.974,92				1.748,09	1.748,09	3.136,14
750,0	799,0	F2160750W1E	1.242,00	1.242,00	2.022,78				1.774,12	1.774,12	3.235,90
800,0	849,0	F2160800W1E	1.293,65	1.293,65	2.070,61				1.804,47	1.804,47	3.340,01
850,0	899,0	F2160850W1E	1.335,77	1.335,76	2.118,44						
900,0	949,0	F2160900W1E	1.383,60	1.383,60	2.219,87						
950,0	999,0	F2160950W1E	1.429,52	1.429,52	2.321,30						
1.000,0	1.049,0	F2161000W1E	1.471,62	1.471,62	2.418,89						
1.050,0	1.099,0	F2161050W1E	1.523,28	1.523,28	2.512,67						
1.100,0	1.149,0	F2161100W1E	1.567,32	1.567,32	2.596,86						
1.150,0	1.199,0	F2161150W1E	1.613,23	1.613,23	2.684,91						
1.200,0	1.249,0	F2161200W1E	1.659,16	1.659,16	2.774,85						
1.250,0	1.299,0	F2161250W1E	1.706,99	1.706,99	2.866,70						
1.300,0	1.349,0	F2161300W1E	1.754,84	1.754,84	2.956,65						
1.350,0	1.399,0	F2161350W1E	1.800,77	1.800,77	3.046,58						
1.400,0	1.449,0	F2161400W1E	1.848,61	1.848,61	3.140,36						
1.450,0	1.499,0	F2161450W1E	1.896,47	1.896,46	3.230,32						

Acoplamiento para tubos de cualquier material sin anclaje axial.

Acoplamiento de unión y compensador todo en uno.

Código W1 en NBR termina W1N
Código W1 en FKM termina W1F

Código W2 en EPDM termina W2E
Código W2 en NBR termina W2N
Código W2 en FKM termina W2F

Código W5 en EPDM termina W5E
Código W5 en NBR termina W5N
Código W5 en FKM termina W5F

(1) Los acoplamientos con la junta en FKM llevan incluido un anillo interior en acero inoxidable
En caso de pedido indicar el diámetro exterior exacto

Junta: EPDM: -20°C hasta +100°C NBR: -20°C hasta +80°C FKM: -20°C hasta +180°C

Fluido: EPDM: Todas las calidades de agua, aguas residuales, aire, sólidos y diversos productos químicos

NBR: Agua, gas, aceite, combustible y otros hidrocarburos
FKM: Ozono, oxígeno, ácidos, gas, aceite y carburantes



FLEX 2 PN20 PN Consultar

J1

desde Ø exterior	hasta Ø exterior	Ref. EPDM	W1 CARCASA GALVANIZADA. CIERRES GALVANIZADOS			W2 CARCASA EN ACERO INOX. CIERRES GALVANIZADOS			W5 CARCASA EN ACERO INOX. CIERRES EN ACERO INOX.		
			€ EPDM	€ NBR	€ FKM (1)	€ EPDM	€ NBR	€ FKM (1)	€ EPDM	€ NBR	€ FKM (1)
180,0	199,0					453,53	453,53	570,28	518,60	518,60	635,35
200,0	224,0					466,93	466,93	608,55	531,99	531,99	673,61
225,0	249,0					478,41	478,41	654,47	543,48	543,48	719,54
250,0	274,0					493,75	493,75	700,41	558,82	558,82	765,48
275,0	299,0	F2200275W1E	581,76	581,77	822,89	505,21	505,21	744,43	570,28	570,28	809,49
300,0	324,0	F2200300W1E	591,34	591,34	864,98	518,60	518,60	792,26	583,65	583,65	857,33
325,0	349,0	F2200325W1E	600,89	600,89	910,91				1.459,62	1.459,62	2.262,11
350,0	374,0	F2200350W1E	610,47	610,47	949,19				1.470,47	1.470,47	2.311,97
375,0	399,0	F2200375W1E	620,05	620,05	995,12				1.487,83	1.487,83	2.366,21
400,0	424,0	F2200400W1E	633,43	633,43	1.041,04				1.498,66	1.498,66	2.413,92
425,0	449,0	F2200425W1E	643,00	643,00	1.077,40				1.511,67	1.511,67	2.463,81
450,0	474,0	F2200450W1E	652,58	652,58	1.117,59				1.529,04	1.529,04	2.515,86
475,0	499,0	F2200475W1E	962,57	962,58	1.454,39				1.542,04	1.542,04	2.563,57
500,0	524,0	F2200500W1E	974,05	974,05	1.498,43				1.555,06	1.555,06	2.615,63
525,0	549,0	F2200525W1E	995,11	995,12	1.548,16				1.568,08	1.568,08	2.665,51
550,0	574,0	F2200550W1E	1.023,82	1.023,81	1.605,57				1.581,08	1.581,08	2.713,22
575,0	599,0	F2200575W1E	1.044,87	1.044,87	1.655,34				1.594,11	1.594,11	2.765,28
600,0	624,0	F2200600W1E	1.106,10	1.106,10	1.716,58				1.641,81	1.641,81	2.847,70
625,0	649,0	F2200625W1E	1.129,06	1.129,07	1.775,89				1.654,82	1.654,82	2.899,76
650,0	674,0	F2200650W1E	1.153,95	1.153,95	1.827,58						
675,0	699,0	F2200675W1E	1.175,00	1.175,00	1.875,41						
700,0	724,0	F2200700W1E	1.197,95	1.197,95	1.925,19						
725,0	749,0	F2200725W1E	1.222,83	1.222,83	1.974,92						
750,0	799,0	F2200750W1E	1.242,00	1.242,00	2.022,78						
800,0	849,0	F2200800W1E	1.293,65	1.293,65	2.070,61						
850,0	899,0	F2200850W1E	1.335,77	1.335,76	2.118,44						
900,0	949,0	F2200900W1E	1.383,60	1.383,60	2.219,87						
950,0	999,0	F2200950W1E	1.429,52	1.429,52	2.321,30						

Acoplamiento para tubos de cualquier material sin anclaje axial.

Acoplamiento de unión y compensador todo en uno.

Código W1 en NBR termina W1N
Código W1 en FKM termina W1F

Código W2 en EPDM termina W2E
Código W2 en NBR termina W2N
Código W2 en FKM termina W2F

Código W5 en EPDM termina W5E
Código W5 en NBR termina W5N
Código W5 en FKM termina W5F

(1) Los acoplamientos con la junta en FKM llevan incluido un anillo interior en acero inoxidable

En caso de pedido indicar el diámetro exterior exacto

Junta: EPDM: -20°C hasta +100°C NBR: -20°C hasta +80°C FKM: -20°C hasta +180°C

Fluido: EPDM: Todas las calidades de agua, aguas residuales, aire, sólidos y diversos productos químicos

NBR: Agua, gas, aceite, combustible y otros hidrocarburos

FKM: Ozono, oxígeno, ácidos, gas, aceite y carburantes

Especificar 1 o 2 cierres



FLEX 2 PN25 PN Consultar

J1

desde Ø exterior	hasta Ø exterior	Ref. EPDM	W1 CARCASA GALVANIZADA. CIERRES GALVANIZADOS			W2 CARCASA EN ACERO INOX. CIERRES GALVANIZADOS			W5 CARCASA EN ACERO INOX. CIERRES EN ACERO INOX.		
			€ EPDM	€ NBR	€ FKM (1)	€ EPDM	€ NBR	€ FKM (1)	€ EPDM	€ NBR	€ FKM (1)
180,0	199,0					453,53	453,53	570,28	518,60	518,60	635,35
200,0	224,0					466,93	466,93	608,55	531,99	531,99	673,61
225,0	249,0					478,41	478,41	654,47	543,48	543,48	719,54
250,0	274,0					493,75	493,75	700,41	558,82	558,82	765,48
275,0	299,0	F2250275W1E	581,76	581,77	822,89				1.433,59	1.433,59	2.166,68
300,0	324,0	F2250300W1E	591,34	591,34	864,98				1.444,46	1.444,46	2.216,56
325,0	349,0	F2250325W1E	600,89	600,89	910,91				1.459,62	1.459,62	2.262,11
350,0	374,0	F2250350W1E	884,13	884,13	1.224,77				1.470,47	1.470,47	2.311,97
375,0	399,0	F2250375W1E	901,34	901,34	1.274,52				1.487,83	1.487,83	2.366,21
400,0	424,0	F2250400W1E	916,66	916,66	1.324,25				1.498,66	1.498,66	2.413,92
425,0	449,0	F2250425W1E	931,96	931,97	1.368,30				1.511,67	1.511,67	2.463,81
450,0	474,0	F2250450W1E	945,37	945,36	1.410,38				1.529,04	1.529,04	2.515,86
475,0	499,0	F2250475W1E	962,57	962,58	1.454,39				1.542,04	1.542,04	2.563,57
500,0	524,0	F2250500W1E	974,05	974,05	1.498,43				1.555,06	1.555,06	2.615,63
525,0	549,0	F2250525W1E	995,11	995,12	1.548,16						
550,0	574,0	F2250550W1E	1.023,82	1.023,81	1.605,57						
575,0	599,0	F2250575W1E	1.044,87	1.044,87	1.655,34						
600,0	624,0	F2250600W1E	1.106,10	1.106,10	1.716,58						
625,0	649,0	F2250625W1E	1.129,06	1.129,07	1.775,89						
650,0	674,0	F2250650W1E	1.153,95	1.153,95	1.827,58						
675,0	699,0	F2250675W1E	1.175,00	1.175,00	1.875,41						
700,0	724,0	F2250700W1E	1.197,95	1.197,95	1.925,19						
725,0	749,0	F2250725W1E	1.222,83	1.222,83	1.974,92						

Acoplamiento para tubos de cualquier material sin anclaje axial.

Acoplamiento de unión y compensador todo en uno.

Código W1 en NBR termina W1N
Código W1 en FKM termina W1F

Código W2 en EPDM termina W2E
Código W2 en NBR termina W2N
Código W2 en FKM termina W2F

Código W5 en EPDM termina W5E
Código W5 en NBR termina W5N
Código W5 en FKM termina W5F

(1) Los acoplamientos con la junta en FKM llevan incluido un anillo interior en acero inoxidable

En caso de pedido indicar el diámetro exterior exacto

Junta: EPDM: -20°C hasta +100°C NBR: -20°C hasta +80°C FKM: -20°C hasta +180°C

Fluido: EPDM: Todas las calidades de agua, aguas residuales, aire, sólidos y diversos productos químicos

NBR: Agua, gas, aceite, combustible y otros hidrocarburos

FKM: Ozono, oxígeno, ácidos, gas, aceite y carburantes

Especificar 1 o 2 cierres



FLEX 3 PN 2,5 PN Consultar

J1

desde Ø exterior	hasta Ø exterior	Ref. EPDM	W1 CARCASA GALVANIZADA. CIERRES GALVANIZADOS		W2 CARCASA EN ACERO INOX. CIERRES GALVANIZADOS		W5 CARCASA EN ACERO INOX. CIERRES EN ACERO INOX.	
			€ EPDM	€ NBR	€ EPDM	€ NBR	€ EPDM	€ NBR
219,1	249,0				912,84	1259,19	1.058,27	1.404,66
250,0	299,0				947,27	1308,96	1.092,71	1.454,39
300,0	349,0	F3020300W1E	1.071,64	1.446,74	1.006,58	1389,32	1.152,05	1.534,79
350,0	399,0	F3020350W1E	1.111,86	1.500,33	1.065,93	1471,62	1.211,37	1.617,06
400,0	449,0	F3020400W1E	1.152,05	1.553,91	1.125,25	1553,91	1.270,69	1.699,36
450,0	499,0	F3020450W1E	1.190,30	1.605,57	1.184,58	1634,29	1.330,01	1.779,72
500,0	549,0	F3020500W1E	1.230,49	1.659,16	1.243,89	1716,58	1.389,32	1.862,01
550,0	599,0	F3020550W1E	1.268,77	1.712,75	1.303,23	1796,94	1.448,67	1.942,39
600,0	649,0	F3020600W1E	1.308,96	1.766,34	1.362,54	1881,14	1.507,99	2.026,60
650,0	699,0	F3020650W1E	1.351,08	1.823,75	1.423,78	1963,43	1.569,22	2.108,88
700,0	749,0	F3020700W1E	1.385,50	1.869,66	1.483,10	2045,73	1.628,55	2.191,17
750,0	799,0	F3020750W1E	1.427,61	1.925,19	1.540,50	2126,10	1.685,95	2.271,53
800,0	849,0	F3020800W1E	1.467,80	1.982,56	1.599,85	2210,29	1.745,28	2.355,76
850,0	899,0	F3020850W1E	1.513,73	2.043,81	1.659,16	2290,69	1.804,60	2.436,12
900,0	949,0	F3020900W1E	1.561,57	2.106,97	1.716,58	2369,13	1.862,01	2.514,59
950,0	999,0	F3020950W1E	1.607,52	2.172,03	1.777,82	2453,35	1.923,24	2.598,78
1.000,0	1.049,0	F3021000W1E	1.655,35	2.235,18	1.833,30	2527,96	1.978,74	2.673,43
1.050,0	1.099,0	F3021050W1E	1.705,09	2.302,17	1.894,55	2614,09	2.039,98	2.759,52
1.100,0	1.149,0	F3021100W1E	1.751,01	2.363,40	1.953,88	2696,38	2.099,32	2.841,82
1.150,0	1.199,0	F3021150W1E	1.789,29	2.416,99	2.013,20	2776,75	2.158,63	2.922,19
1.200,0	1.249,0	F3021200W1E	1.844,78	2.491,62	2.049,56	2828,41	2.195,00	2.973,88
1.250,0	1.299,0	F3021250W1E	1.902,19	2.568,15	2.089,73	2883,92	2.235,18	3.029,36
1.300,0	1.349,0	F3021300W1E	1.957,72	2.642,80	2.126,10	2935,59	2.271,53	3.081,02
1.350,0	1.399,0	F3021350W1E	2.015,09	2.719,33	2.166,29	2991,08	2.311,74	3.136,53
1.400,0	1.449,0	F3021400W1E	2.070,61	2.795,88	2.208,40	3046,58	2.353,83	3.192,03
1.450,0	1.499,0	F3021450W1E	2.124,19	2.868,63	2.258,15	3115,48	2.403,59	3.260,91
1.500,0	1.549,0	F3021500W1E	2.181,62	2.945,16	2.309,81	3188,20	2.455,25	3.333,63
1.550,0	1.599,0	F3021550W1E	2.235,18	3.017,88	2.499,26	3450,39	2.644,72	3.595,82
1.600,0	1.649,0	F3021600W1E	2.284,93	3.084,85	2.554,77	3525,00	2.700,21	3.670,43
1.650,0	1.699,0	F3021650W1E	2.336,59	3.153,74	2.608,36	3599,65	2.753,79	3.745,08
1.700,0	1.749,0	F3021700W1E	2.382,53	3.216,91	2.661,92	3672,35	2.807,38	3.817,80
1.750,0	1.799,0	F3021750W1E	2.441,87	3.297,27	2.795,88	3857,99	2.941,34	4.003,43
1.800,0	1.849,0	F3021800W1E	2.505,01	3.381,46	2.859,04	3944,10	3.004,48	4.089,53
1.850,0	1.899,0	F3021850W1E	2.566,25	3.465,69	2.914,53	4022,58	3.060,00	4.168,00
1.900,0	1.949,0	F3021900W1E	2.629,40	3.549,88	2.973,88	4102,94	3.119,31	4.248,37
1.950,0	1.999,0	F3021950W1E	2.694,45	3.636,01	3.033,19	4187,13	3.178,62	4.332,59
2.000,0	2.032,0	F3022000W1E	2.759,52	3.725,95	3.107,83	4288,56	3.253,27	4.434,01

Acoplamiento para tubos de cualquier material sin anclaje axial.

Acoplamiento de unión y compensador todo en uno.

Código W1 en NBR termina W1N

Código W2 en EPDM termina W2E
Código W2 en NBR termina W2N

Código W5 en EPDM termina W5E
Código W5 en NBR termina W5N

En caso de pedido indicar el diámetro exterior exacto

Junta: EPDM: -20°C hasta +100°C NBR: -20°C hasta +80°C

Fluido: EPDM: Todas las calidades de agua, aguas residuales, aire, sólidos y diversos productos químicos

NBR: Agua, gas, aceite, combustible y otros hidrocarburos

Especificar 1 o 2 cierres



FLEX 3 PN 6 PN Consultar

J1

desde Ø exterior	hasta Ø exterior	Ref. EPDM	W1 CARCASA GALVANIZADA. CIERRES GALVANIZADOS		W2 CARCASA EN ACERO INOX. CIERRES GALVANIZADOS		W5 CARCASA EN ACERO INOX. CIERRES EN ACERO INOX.	
			€ EPDM	€ NBR	€ EPDM	€ NBR	€ EPDM	€ NBR
219,1	249,0				912,84	1259,19	1.058,27	1.404,66
250,0	299,0				947,27	1308,96	1.092,71	1.454,39
300,0	349,0	F3060300W1E	1.071,64	1.446,74	1.006,58	1389,32	1.152,05	1.534,79
350,0	399,0	F3060350W1E	1.111,86	1.500,33	1.065,93	1471,62	1.211,37	1.617,06
400,0	449,0	F3060400W1E	1.152,05	1.553,91	1.125,25	1553,91	1.270,69	1.699,36
450,0	499,0	F3060450W1E	1.190,30	1.605,57	1.184,58	1634,29	1.330,01	1.779,72
500,0	549,0	F3060500W1E	1.230,49	1.659,16	1.243,89	1716,58	1.389,32	1.862,01
550,0	599,0	F3060550W1E	1.268,77	1.712,75	1.303,23	1796,94	1.448,67	1.942,39
600,0	649,0	F3060600W1E	1.308,96	1.766,34	1.362,54	1881,14	1.507,99	2.026,60
650,0	699,0	F3060650W1E	1.351,08	1.823,75	1.423,78	1963,43	1.569,22	2.108,88
700,0	749,0	F3060700W1E	1.385,50	1.869,66	1.483,10	2045,73	1.628,55	2.191,17
750,0	799,0	F3060750W1E	1.427,61	1.925,19	1.540,50	2126,10	1.685,95	2.271,53
800,0	849,0	F3060800W1E	1.467,80	1.982,56	1.599,85	2210,29	1.745,28	2.355,76
850,0	899,0	F3060850W1E	1.513,73	2.043,81	1.659,16	2290,69	1.804,60	2.436,12
900,0	949,0	F3060900W1E	1.561,57	2.106,97	1.716,58	2369,13	1.862,01	2.514,59
950,0	999,0	F3060950W1E	1.607,52	2.172,03	1.777,82	2453,35	1.923,24	2.598,78
1.000,0	1.049,0	F3061000W1E	1.655,35	2.235,18			2.836,84	3.012,52
1.050,0	1.099,0	F3061050W1E	1.705,09	2.302,17			2.891,06	3.073,24
1.100,0	1.149,0	F3061100W1E	1.751,01	2.363,40			2.943,11	3.131,81
1.150,0	1.199,0	F3061150W1E	1.789,29	2.416,99			3.001,67	3.203,36
1.200,0	1.249,0	F3061200W1E	1.844,78	2.491,62			3.064,58	3.272,78
1.250,0	1.299,0	F3061250W1E	1.902,19	2.568,15			3.127,48	3.342,20
1.300,0	1.349,0	F3061300W1E	1.957,72	2.642,80			3.188,20	3.411,59
1.350,0	1.399,0	F3061350W1E	2.015,09	2.719,33			3.251,11	3.480,98
1.400,0	1.449,0	F3061400W1E	2.070,61	2.795,88			3.305,32	3.546,05
1.450,0	1.499,0	F3061450W1E	2.124,19	2.868,63			3.383,40	3.632,80
1.500,0	1.549,0	F3061500W1E	2.181,62	2.945,16			3.457,12	3.713,06
1.550,0	1.599,0	F3061550W1E	2.235,18	3.017,88			3.515,69	3.780,29
1.600,0	1.649,0	F3061600W1E	2.284,93	3.084,85			3.580,76	3.851,87
1.650,0	1.699,0	F3061650W1E	2.336,59	3.153,74			3.654,51	3.934,29
1.700,0	1.749,0	F3061700W1E	2.382,53	3.216,91			3.728,25	4.016,69
1.750,0	1.799,0	F3061750W1E	2.441,87	3.297,27			3.801,97	4.096,96
1.800,0	1.849,0	F3061800W1E	2.505,01	3.381,46			4.077,43	4.381,05
1.850,0	1.899,0	F3061850W1E	2.566,25	3.465,69			4.133,80	4.446,11
1.900,0	1.949,0	F3061900W1E	2.629,40	3.549,88			4.185,86	4.506,86
1.950,0	1.999,0	F3061950W1E	2.694,45	3.636,01			4.255,27	4.582,76
2.000,0	2.032,0	F3062000W1E	2.759,52	3.725,95			4.329,00	4.665,18

Acoplamiento para tubos de cualquier material sin anclaje axial.

Acoplamiento de unión y compensador todo en uno.

Código W1 en NBR termina W1N

Código W2 en EPDM termina W2E
Código W2 en NBR termina W2N

Código W5 en EPDM termina W5E
Código W5 en NBR termina W5N

En caso de pedido indicar el diámetro exterior exacto

Junta: EPDM: -20°C hasta +100°C NBR: -20°C hasta +80°C

Fluido: EPDM: Todas las calidades de agua, aguas residuales, aire, sólidos y diversos productos químicos

NBR: Agua, gas, aceite, combustible y otros hidrocarburos

Especificar 1 o 2 cierres



FLEX 3 PN 10 PN Consultar

J1

desde Ø exterior	hasta Ø exterior	Ref. EPDM	W1 CARCASA GALVANIZADA. CIERRES GALVANIZADOS		W2 CARCASA EN ACERO INOX. CIERRES GALVANIZADOS		W5 CARCASA EN ACERO INOX. CIERRES EN ACERO INOX.	
			€ EPDM	€ NBR	€ EPDM	€ NBR	€ EPDM	€ NBR
219,1	249,0				912,84	1259,19	1.058,27	1.404,66
250,0	299,0				947,27	1308,96	1.092,71	1.454,39
300,0	349,0	F3100300W1E	1.071,64	1.446,74	1.006,58	1389,32	1.152,05	1.534,79
350,0	399,0	F3100350W1E	1.111,86	1.500,33	1.065,93	1471,62	1.211,37	1.617,06
400,0	449,0	F3100400W1E	1.152,05	1.553,91	1.125,25	1553,91	1.270,69	1.699,36
450,0	499,0	F3100450W1E	1.190,30	1.605,57	1.184,58	1634,29	1.330,01	1.779,72
500,0	549,0	F3100500W1E	1.230,49	1.659,16			1.389,32	1.862,01
525,0	549,0			-			-	-
550,0	599,0	F3100550W1E	1.268,77	1.712,75			1.448,67	1.942,39
575,0	599,0			-			-	-
600,0	649,0	F3100600W1E	1.308,96	1.766,34			1.507,99	2.026,60
650,0	699,0	F3100650W1E	1.351,08	1.823,75			1.569,22	2.108,88
700,0	749,0	F3100700W1E	1.385,50	1.869,66			1.628,55	2.191,17
750,0	799,0	F3100750W1E	1.427,61	1.925,19			1.685,95	2.271,53
800,0	849,0	F3100800W1E	1.467,80	1.982,56			1.745,28	2.355,76
850,0	899,0	F3100850W1E	1.513,73	2.043,81			1.804,60	2.436,12
900,0	949,0	F3100900W1E	1.561,57	2.106,97			1.862,01	2.514,59
950,0	999,0	F3100950W1E	1.607,52	2.172,03			1.923,24	2.598,78
1.000,0	1.049,0	F3101000W1E	1.655,35	2.235,18			2.836,84	3.012,52
1.050,0	1.099,0	F3101050W1E	1.705,09	2.302,17			2.891,06	3.073,24
1.100,0	1.149,0	F3101100W1E	1.751,01	2.363,40			2.943,11	3.131,81
1.150,0	1.199,0	F3101150W1E	1.789,29	2.416,99			3.001,67	3.203,36
1.200,0	1.249,0	F3101200W1E	1.844,78	2.491,62			3.064,58	3.272,78
1.250,0	1.299,0	F3101250W1E	4.292,15	4.806,16			3.127,48	3.342,20
1.300,0	1.349,0	F3101300W1E	4.368,04	4.892,90			3.188,20	3.411,59
1.350,0	1.399,0	F3101350W1E	4.450,46	4.984,00			3.251,11	3.480,98
1.400,0	1.449,0	F3101400W1E	4.532,89	5.075,09			3.305,32	3.546,05
1.450,0	1.499,0	F3101450W1E	4.613,12	5.166,18			Consultar	Consultar
1.500,0	1.549,0	F3101500W1E	4.695,56	5.259,43				
1.550,0	1.599,0	F3101550W1E	4.773,63	5.346,21				
1.600,0	1.649,0	F3101600W1E	4.856,03	5.437,30				
1.650,0	1.699,0	F3101650W1E	4.936,28	5.530,55				
1.700,0	1.749,0	F3101700W1E	5.018,68	5.623,79				
1.750,0	1.799,0	F3101750W1E	5.096,78	5.708,39				
1.800,0	1.849,0	F3101800W1E	5.179,19	5.801,66				
1.850,0	1.899,0	F3101850W1E	5.261,62	5.892,75				
1.900,0	1.949,0	F3101900W1E	5.344,01	5.983,85				
1.950,0	1.999,0	F3101950W1E	5.422,11	6.072,75				
2.000,0	2.032,0	F3102000W1E	5.498,01	6.157,34				

Acoplamiento para tubos de cualquier material sin anclaje axial.

Acoplamiento de unión y compensador todo en uno.

Código W1 en NBR termina W1N

Código W2 en EPDM termina W2E
Código W2 en NBR termina W2N

Código W5 en EPDM termina W5E
Código W5 en NBR termina W5N

En caso de pedido indicar el diámetro exterior exacto

Junta: EPDM: -20°C hasta +100°C NBR: -20°C hasta +80°C

Fluido: EPDM: Todas las calidades de agua, aguas residuales, aire, sólidos y diversos productos químicos

NBR: Agua, gas, aceite, combustible y otros hidrocarburos

Especificar 1 o 2 cierres



FLEX 3 PN 16 Consultar

J1

desde Ø exterior	hasta Ø exterior	Ref. EPDM	W1 CARCASA GALVANIZADA. CIERRES GALVANIZADOS		W2 CARCASA EN ACERO INOX. CIERRES GALVANIZADOS		W5 CARCASA EN ACERO INOX. CIERRES EN ACERO INOX.	
			€ EPDM	€ NBR	€ EPDM	€ NBR	€ EPDM	€ NBR
219,1	249,0				912,84	1259,19	1.058,27	1.404,66
250,0	299,0				947,27	1308,96	1.092,71	1.454,39
300,0	349,0	F3160300W1E	1.071,64	1.446,74	1.006,58	1389,32	1.152,05	1.534,79
350,0	399,0	F3160350W1E	1.111,86	1.500,33			1.826,17	1.891,24
375,0	399,0			-			1.867,37	1.938,94
400,0	449,0	F3160400W1E	1.152,05	1.553,91			1.910,77	1.986,65
425,0	449,0			-			1.951,96	2.032,19
450,0	499,0	F3160450W1E	1.190,30	1.605,57			1.997,51	2.082,10
475,0	499,0			-			2.043,06	2.131,98
500,0	549,0	F3160500W1E	1.230,49	1.659,16			2.088,59	2.179,68
525,0	549,0			-			2.136,30	2.231,74
550,0	599,0	F3160550W1E	1.268,77	1.712,75			2.184,03	2.283,79
575,0	599,0			-			2.233,90	2.335,85
600,0	649,0	F3160600W1E	1.308,96	1.766,34			2.294,65	2.405,26
650,0	699,0	F3160650W1E	1.351,08	1.823,75			2.346,69	2.465,97
700,0	749,0	F3160700W1E	1.385,50	1.869,66			2.398,75	2.526,70
750,0	799,0	F3160750W1E	3.483,15	3.901,76			2.455,12	2.591,76
800,0	849,0	F3160800W1E	3.561,24	3.988,51			2.515,86	2.659,01
850,0	899,0	F3160850W1E	3.643,65	4.079,59			Consultar	Consultar
900,0	949,0	F3160900W1E	3.719,57	4.166,33				
950,0	999,0	F3160950W1E	3.801,97	4.257,43				
1.000,0	1.049,0	F3161000W1E	3.884,39	4.348,52				
1.050,0	1.099,0	F3161050W1E	3.966,83	4.443,95				
1.100,0	1.149,0	F3161100W1E	4.042,71	4.528,54				
1.150,0	1.199,0	F3161150W1E	4.125,14	4.621,80				
1.200,0	1.249,0	F3161200W1E	4.209,72	4.712,89				
1.250,0	1.299,0	F3161250W1E	4.292,15	4.806,16				
1.300,0	1.349,0	F3161300W1E	4.368,04	4.892,90				
1.350,0	1.399,0	F3161350W1E	4.450,46	4.984,00				
1.400,0	1.449,0	F3161400W1E	4.532,89	5.075,09				
1.450,0	1.499,0	F3161450W1E	4.613,12	5.166,18				
1.500,0	1.549,0	F3161500W1E	4.695,56	5.259,43				
1.550,0	1.599,0	F3161550W1E	Consultar	Consultar				

Acoplamiento para tubos de cualquier material sin anclaje axial.

Acoplamiento de unión y compensador todo en uno.

Código W1 en NBR termina W1N

Código W2 en EPDM termina W2E
Código W2 en NBR termina W2N

Código W5 en EPDM termina W5E
Código W5 en NBR termina W5N

En caso de pedido indicar el diámetro exterior exacto

Junta: EPDM: -20°C hasta +100°C NBR: -20°C hasta +80°C

Fluido: EPDM: Todas las calidades de agua, aguas residuales, aire, sólidos y diversos productos químicos

NBR: Agua, gas, aceite, combustible y otros hidrocarburos

Especificar 1 o 2 cierres



FLEX 3 PN 20



PN



Consultar

J1

desde Ø exterior	hasta Ø exterior	W1 CARCASA GALVANIZADA. CIERRES GALVANIZADOS				W5 CARCASA EN ACERO INOX. CIERRES EN ACERO INOX.			
		Ref. EPDM	€ EPDM	Ref. NBR	€ NBR	Ref. EPDM	€ EPDM	Ref. NBR	€ NBR
300,0	324,0					F3200300W5E	1.522,37	F3200300W5N	1.804,46
323,9	349,0	F3200323W1E	1.071,64	F3200323W1N	1.446,74				
325,0	349,0					F3200325W5E	1.782,79	F3200325W5N	1.847,86
350,0	399,0	F3200350W1E	1.111,86	F3200350W1N	1.500,33	F3200350W5E	1.826,17	F3200350W5N	1.891,24
375,0	399,0					F3200375W5E	1.867,37	F3200375W5N	1.938,95
400,0	449,0	F3200400W1E	1.152,05	F3200400W1N	1.553,91	F3200400W5E	1.910,77	F3200400W5N	1.986,65
425,0	449,0					F3200425W5E	1.951,96	F3200425W5N	2.032,19
450,0	499,0	F3200450W1E	1.190,30	F3200450W1N	1.605,58	F3200450W5E	1.997,50	F3200450W5N	2.082,10
475,0	499,0					F3200475W5E	2.043,06	F3200475W5N	2.131,98
500,0	549,0	F3200500W1E	1.230,49	F3200500W1N	1.659,16	F3200500W5E	2.088,59	F3200500W5N	2.179,68
525,0	549,0					F3200525W5E	2.136,29	F3200525W5N	2.231,74
550,0	599,0	F3200550W1E	3.181,69	F3200550W1N	3.563,42	F3200550W5E	2.184,03	F3200550W5N	2.283,79
575,0	599,0					F3200575W5E	2.233,90	F3200575W5N	2.335,85
600,0	649,0	F3200600W1E	3.242,41	F3200600W1N	3.630,64	F3200600W5E	2.294,65	F3200600W5N	2.405,26
650,0	699,0	F3200650W1E	3.324,83	F3200650W1N		F3200650W5E	Consultar	F3200650W5N	Consultar
700,0	749,0	F3200700W1E	3.402,92	F3200700W1N	3.808,47				
750,0	799,0	F3200750W1E	3.483,15	F3200750W1N	3.901,76				
800,0	849,0	F3200800W1E	3.561,24	F3200800W1N	3.988,49				
850,0	899,0	F3200850W1E	3.643,65	F3200850W1N	4.079,59				
900,0	949,0	F3200900W1E	3.719,57	F3200900W1N	4.166,34				
950,0	999,0	F3200950W1E	3.801,97	F3200950W1N	4.257,42				
1.000,0	1.049,0	F3201000W1E	3.884,39	F3201000W1N	4.348,52				
1.050,0	1.099,0	F3201050W1E	3.966,83	F3201050W1N	4.443,96				
1.100,0	1.149,0	F3201100W1E	4.042,71	F3201100W1N	4.528,55				
1.150,0	1.149,0	F3201150W1E	Consultar	F3201150W1N	Consultar				

Acoplamiento para tubos de cualquier material sin anclaje axial.
Acoplamiento de unión y compensador todo en uno.

En caso de pedido indicar el diámetro exterior exacto

Junta: EPDM: -20°C hasta +100°C

NBR: -20°C hasta +80°C

Fluido: EPDM: Todas las calidades de agua, aguas residuales, aire, sólidos y diversos productos químicos

NBR: Agua, gas, aceite, combustible y otros hidrocarburos
Especificar 1 o 2 cierres



FLEX 3 PN 25 PN Consultar

J1

desde Ø exterior	hasta Ø exterior	W1 CARCASA GALVANIZADA CIERRES GALVANIZADOS				W5 CARCASA EN ACERO INOX. CIERRES EN ACERO INOX.			
		Ref. EPDM	€ EPDM	Ref. NBR	€ NBR	Ref. EPDM	€ EPDM	Ref. NBR	€ NBR
300,0	324,0					F3250300W5E	1.739,42	F3250300W5N	1.804,46
323,9	349,0	F3250323W1E	1.071,64	F3250323W1N	1446,74	F3250323W5E	1.782,79	F3250323W5N	1.847,86
350,0	399,0	F3250350W1E	1.111,86	F3250350W1N	1500,33	F3250350W5E	1.826,17	F3250350W5N	1.891,24
375,0	399,0					F3250375W5E	1.867,37	F3250375W5N	1.938,95
400,0	449,0	F3250400W1E	1.152,05	F3250400W1N	1553,91	F3250400W5E	1.910,77	F3250400W5N	1.986,65
425,0	449,0					F3250425W5E	1.951,96	F3250425W5N	2.032,19
450,0	499,0	F3250450W1E	1.190,30	F3250450W1N	1605,57	F3250450W5E	1.997,50	F3250450W5N	2.082,10
475,0	499,0					F3250475W5E	2.043,06	F3250475W5N	2.131,98
500,0	549,0					F3250500W5E	Consultar	F3250500W5N	Consultar
550,0	599,0	F3250550W1E	3.242,41	F3250550W1N	3563,42				
600,0	649,0	F3250600W1E	3.324,83	F3250600W1N	3630,64				
650,0	699,0	F3250650W1E	3.402,92	F3250650W1N	3723,89				
700,0	749,0	F3250700W1E	3.483,15	F3250700W1N	3808,47				
750,0	799,0	F3250750W1E	3.561,24	F3250750W1N	3901,76				
800,0	849,0	F3250800W1E	3.643,65	F3250800W1N	3988,52				
850,0	899,0	F3250850W1E	3.719,57	F3250850W1N	4079,59				
900,0	949,0	F3250900W1E	3.719,57	F3250900W1N	4166,34				
950,0	999,0	F3250950W1E	Consultar	F3250950W1N	Consultar				

Acoplamiento para tubos de cualquier material sin anclaje axial.
Acoplamiento de unión y compensador todo en uno.

En caso de pedido indicar el diámetro exterior exacto

Junta: EPDM: -20°C hasta +100°C NBR: -20°C hasta +80°C



Fluido: EPDM: Todas las calidades de agua, aguas residuales, aire, sólidos y diversos productos químicos

NBR: Agua, gas, aceite, combustible y otros hidrocarburos
Especificar 1 o 2 cierres



OPEN FLEX 1

J1

diámetro exterior			CARCASA EN ACERO GALVANIZADO					
	 PN (bar)	 PN (bar)	Ref. EPDM	€ EPDM	Ref. NBR	€ NBR	Ref. FKM (1)	€ FKM
48,3	25,0	16,0	35001	94,36	35003	94,36	35009	153,95
54,0	25,0	16,0	35051	97,18	35053	97,18	35057	157,09
57,0	25,0	16,0	35101	98,77	35103	98,77	35106	160,38
60,3	25,0	16,0	35151	100,31	35153	100,31	35166	161,96
73,0	25,0	16,0	35201	109,12	35203	109,12	35213	182,39
76,1	25,0	16,0	35251	110,07	35253	110,07	35267	185,54
84,0	25,0	16,0	35301	112,58	35303	112,58	35309	190,25
88,9	25,0	16,0	35351	114,33	35353	114,33	35368	191,85
100,6	25,0	16,0	35401	117,47	35403	117,47	35411	196,54
101,6	25,0	16,0	35451	117,77	35453	117,77	35459	196,54
104,0	20,0	16,0	35501	118,08	35503	118,08	35514	198,14
104,8	20,0	16,0	35551	118,41	35553	118,41	35559	198,14
108,0	20,0	16,0	35601	119,67	35603	119,67	35614	199,69
114,3	20,0	16,0	35651	120,77	35653	120,77	35645	201,28
118,0	20,0	16,0	35671	121,55	35673	121,55	35636	213,84
127,0	20,0	16,0	35676	145,93	35678	145,93	35685	231,15
129,0	20,0	16,0	35701	146,70	35703	146,70	35709	232,71
130,2	20,0	16,0	35751	147,64	35753	147,64	35759	234,30
133,0	16,0	16,0	35801	149,55	35803	149,55	35814	235,85
139,7	16,0	16,0	35851	152,04	35853	152,04	35858	246,87
141,3	16,0	16,0	35901	152,37	35903	152,37	35912	248,45
154,0	16,0	16,0	35951	156,77	35953	156,77	35958	262,59
159,0	16,0	16,0	36001	158,80	36003	158,80	36016	268,90
168,3	16,0	16,0	36051	163,53	36053	163,53	36067	278,32

Acoplamiento abierto para tubos de cualquier material sin anclaje axial.
 Abierta con bisagra.

(1) acoplamiento con anillo interior en acero inoxidable incorporado

Junta: EPDM: -20°C hasta +100°C NBR: -20°C hasta +80°C FKM: -20°C hasta +180°C

Fluido: EPDM: Todas las calidades de agua, aguas residuales, aire, sólidos y diversos productos químicos
 NBR: Agua, gas, aceite, combustible y otros hidrocarburos
 FKM: Ozono, oxígeno, ácidos, gas, aceite y carburantes



OPEN FLEX 1

J1

diámetro exterior	PN (bar)	PN (bar)	CARCASA EN ACERO INOXIDABLE					
			Ref. EPDM	€ EPDM	Ref. NBR	€ NBR	Ref. FKM (1)	€ FKM
48,3	25,0	16,0	35000	119,35	35002	119,35	35007	177,68
54,0	25,0	16,0	35050	122,18	35052	122,18	35056	182,39
57,0	25,0	16,0	35100	123,11	35102	123,11	35108	183,98
60,3	25,0	16,0	35150	124,84	35152	124,84	35168	185,54
73,0	25,0	16,0	35200	134,27	35202	134,27	35209	209,13
76,1	25,0	16,0	35250	135,24	35252	135,24	35268	210,71
84,0	25,0	16,0	35300	137,74	35302	137,74	35308	213,84
88,9	25,0	16,0	35350	139,47	35352	139,47	35369	216,99
100,6	25,0	16,0	35400	142,47	35402	142,47	35410	220,14
101,6	25,0	16,0	35450	142,77	35452	142,77	35458	221,72
104,0	20,0	16,0	35500	143,26	35502	143,26	35515	221,72
104,8	20,0	16,0	35550	143,56	35552	143,56	35558	223,28



Acoplamiento abierto para tubos de cualquier material sin anclaje axial.

Abierto con bisagra.

Continúa en la página siguiente...

J1

CARCASA EN ACERO INOXIDABLE

diámetro exterior	 PN (bar)	 PN (bar)	Ref. EPDM	€ EPDM	Ref. NBR	€ NBR	Ref. FKM (1)	€ FKM
108,0	20,0	16,0	35600	144,49	35602	144,49	35609	224,86
114,3	20,0	16,0	35650	145,93	35652	145,93	35644	237,44
118,0	20,0	16,0	35670	146,70	35672	146,70	35635	226,42
127,0	20,0	16,0	35675	177,68	35677	177,68	35684	264,17
129,0	20,0	16,0	35700	179,24	35702	179,24	35708	265,73
130,2	20,0	16,0	35750	179,24	35752	179,24	35758	267,31
133,0	16,0	16,0	35800	180,84	35802	180,84	35813	268,90
139,7	16,0	16,0	35850	183,98	35852	183,98	35854	278,32
141,3	16,0	16,0	35900	183,98	35902	183,98	35911	278,32
154,0	16,0	16,0	35950	190,25	35952	190,25	35954	294,05
159,0	16,0	16,0	36000	193,41	36002	193,41	36015	301,91
168,3	16,0	16,0	36050	196,54	36052	196,54	36066	311,34

(1) acoplamiento con anillo interior en acero inoxidable incorporado

Junta: EPDM: -20°C hasta +100°C NBR: -20°C hasta +80°C FKM: -20°C hasta +180°C

Fluido: EPDM: Todas las calidades de agua, aguas residuales, aire, sólidos y diversos productos químicos
 NBR: Agua, gas, aceite, combustible y otros hidrocarburos
 FKM: Ozono, oxígeno, ácidos, gas, aceite y carburantes

OPEN FLEX 2 PN 2,5

J1

desde Ø exterior	hasta Ø exterior	Ref. EPDM	W1 CARCASA GALVANIZADA. CIERRES GALVANIZADOS			W2 CARCASA EN ACERO INOX. CIERRES GALVANIZADOS			W5 CARCASA EN ACERO INOX. CIERRES EN ACERO INOX.		
			€ EPDM	€ NBR	€ FKM (1)	€ EPDM	€ NBR	€ FKM (1)	€ EPDM	€ NBR	€ FKM (1)
172,0	199,0					443,98	443,98	595,16	505,21	505,21	656,40
200,0	224,0					459,29	459,29	635,35	520,53	520,53	696,58
225,0	249,0					468,86	468,86	675,53	530,10	530,10	736,77
250,0	274,0					482,24	482,24	717,65	543,48	543,48	778,85
275,0	299,0	OF2020275W1E	926,22	926,22	1.167,34	493,75	493,75	761,65	554,99	554,99	822,89
300,0	324,0	OF2020300W1E	941,51	941,51	1.217,11	509,04	509,04	801,84	570,28	570,28	863,07
325,0	349,0	OF2020325W1E	958,75	958,75	1.266,84	518,60	518,60	843,92	579,84	579,84	905,16
350,0	374,0	OF2020350W1E	974,05	974,05	1.312,79	533,92	533,92	889,86	595,16	595,16	951,10
375,0	399,0	OF2020375W1E	991,29	991,29	1.366,37	543,48	543,48	928,14	604,72	604,72	989,38
400,0	424,0	OF2020400W1E	1.006,58	1.006,58	1.416,14	553,06	553,06	970,22	614,29	614,29	1.031,46
425,0	449,0	OF2020425W1E	1.025,74	1.025,74	1.460,14	574,11	574,11	1.016,17	635,35	635,35	1.077,40
450,0	474,0	OF2020450W1E	1.041,03	1.041,04	1.506,08	585,60	585,60	1.056,35	646,83	646,83	1.117,59
475,0	499,0	OF2020475W1E	1.056,35	1.056,35	1.550,08	602,82	602,82	1.100,36	664,06	664,06	1.161,59
500,0	524,0	OF2020500W1E	1.071,64	1.071,65	1.596,03	618,12	618,12	1.142,47	679,36	679,36	1.203,71
525,0	549,0	OF2020525W1E	1.094,64	1.094,64	1.645,76	639,18	639,18	1.190,30	700,41	700,41	1.251,55
550,0	574,0	OF2020550W1E	1.125,25	1.125,25	1.708,92	650,66	650,66	1.232,41	711,90	711,90	1.293,65
575,0	599,0	OF2020575W1E	1.148,22	1.148,22	1.760,59	667,89	667,89	1.272,60	729,12	729,12	1.333,84
600,0	624,0	OF2020600W1E	1.217,12	1.217,11	1.827,58	773,14	773,14	1.387,42	834,37	834,37	1.448,67
625,0	649,0	OF2020625W1E	1.240,07	1.240,07	1.886,90	794,19	794,19	1.444,84	855,43	855,43	1.506,08
650,0	674,0	OF2020650W1E	1.266,84	1.266,84	1.942,39	813,31	813,31	1.490,75	874,56	874,56	1.551,99
675,0	699,0	OF2020675W1E	1.291,72	1.291,73	1.990,25	838,20	838,20	1.536,69	899,44	899,44	1.597,92
700,0	724,0	OF2020700W1E	1.318,54	1.318,54	2.045,73	853,50	853,50	1.578,79	914,73	914,73	1.640,04
725,0	749,0	OF2020725W1E	1.343,42	1.343,42	2.097,39	876,45	876,45	1.624,71	937,70	937,70	1.685,95
750,0	799,0	OF2020750W1E	1.364,45	1.364,45	2.128,02	1041,04	1.041,04	1.729,99	1.102,28	1.102,28	1.791,22
800,0	849,0	OF2020800W1E	1.419,95	1.419,95	2.191,17	1077,40	1.077,40	1.821,83	1.138,64	1.138,64	1.883,07

Acoplamiento abierto para tubos de cualquier material sin anclaje axial.
Abierto con bisagra.

Código W1 en NBR termina W1N
Código W1 en FKM termina W1F

Código W2 en EPDM termina W2E
Código W2 en NBR termina W2N
Código W2 en FKM termina W2F

Código W5 en EPDM termina W5E
Código W5 en NBR termina W5N
Código W5 en FKM termina W5F

Continúa en la página siguiente...

J1

desde Ø exterior	hasta Ø exterior	Ref. EPDM	W1 CARCASA GALVANIZADA. CIERRES GALVANIZADOS			W2 CARCASA EN ACERO INOX. CIERRES GALVANIZADOS			W5 CARCASA EN ACERO INOX. CIERRES EN ACERO INOX.		
			€ EPDM	€ NBR	€ FKM (1)	€ EPDM	€ NBR	€ FKM (1)	€ EPDM	€ NBR	€ FKM (1)
850,0	899,0	OF2020850W1E	1.469,72	1.469,72	2.252,40	1115,69	1.115,69	1.909,85	1.176,93	1.176,93	1.971,09
900,0	949,0	OF2020900W1E	1.519,45	1.519,45	2.355,76	1155,88	1.155,88	1.999,80	1.217,11	1.217,11	2.061,03
950,0	999,0	OF2020950W1E	1.571,14	1.571,14	2.464,84	1192,23	1.192,23	2.089,73	1.253,47	1.253,47	2.150,98
1.000,0	1.049,0	OF2021000W1E	1.620,89	1.620,89	2.566,25	1234,32	1.234,32	2.179,68	1.295,55	1.295,55	2.240,93
1.050,0	1.099,0	OF2021050W1E	1.678,30	1.678,29	2.667,67	1286,01	1.286,01	2.273,47	1.347,25	1.347,25	2.334,70
1.100,0	1.149,0	OF2021100W1E	1.722,31	1.722,31	2.751,87	1341,49	1.341,49	2.371,05	1.402,74	1.402,74	2.432,30
1.150,0	1.199,0	OF2021150W1E	1.773,99	1.773,99	2.845,64	1395,08	1.395,08	2.464,84	1.456,32	1.456,32	2.526,07
1.200,0	1.249,0	OF2021200W1E	1.825,66	1.825,66	2.941,34	1448,67	1.448,67	2.558,60	1.509,91	1.509,91	2.619,84
1.250,0	1.299,0	OF2021250W1E	1.877,32	1.877,32	3.035,12	1502,25	1.502,25	2.654,27	1.563,49	1.563,49	2.715,50
1.300,0	1.349,0	OF2021300W1E	1.927,08	1.927,07	3.130,78	1555,82	1.555,82	2.749,97	1.617,06	1.617,06	2.811,21
1.350,0	1.399,0	OF2021350W1E	1.978,74	1.978,74	3.224,56	1607,51	1.607,51	2.843,75	1.668,75	1.668,75	2.904,99
1.400,0	1.449,0	OF2021400W1E	2.030,42	2.030,43	3.322,15	1661,09	1.661,09	2.939,41	1.722,31	1.722,31	3.000,66
1.450,0	1.499,0	OF2021450W1E	2.082,10	2.082,10	3.415,93	1714,65	1.714,65	3.035,12	1.775,89	1.775,89	3.096,36
1.500,0	1.549,0	OF2021500W1E	2.131,84	2.131,85	3.509,70	2214,15	2.214,15	3.591,99	2.279,20	2.279,20	3.657,06
1.550,0	1.600,0	OF2021550W1E	2.183,51	2.183,51	3.605,37	2281,10	2.281,10	3.701,07	2.346,17	2.346,17	3.766,14
1.600,0	1.649,0	OF2021600W1E	2.235,18	2.235,18	3.699,14	2348,10	2.348,10	3.812,06	2.413,17	2.413,17	3.877,13
1.650,0	1.699,0	OF2021650W1E	2.286,87	2.286,86	3.794,84	2415,06	2.415,06	3.923,04	2.480,13	2.480,13	3.988,11
1.700,0	1.749,0	OF2021700W1E	2.338,52	2.338,52	3.888,61	2482,06	2.482,06	4.032,12	2.547,13	2.547,13	4.097,19
1.750,0	1.799,0	OF2021750W1E	2.388,28	2.388,28	3.984,29	2549,03	2.549,03	4.143,13	2.614,09	2.614,09	4.208,20
1.800,0	1.849,0	OF2021800W1E	2.439,95	2.439,95	4.078,06	2616,01	2.616,01	4.254,12	2.681,08	2.681,08	4.319,19
1.850,0	1.899,0	OF2021850W1E	2.491,61	2.491,62	4.173,76	2682,99	2.682,99	4.363,20	2.748,04	2.748,04	4.428,27
1.900,0	1.949,0	OF2021900W1E	2.543,30	2.543,30	4.267,53	2749,97	2.749,97	4.474,20	2.815,04	2.815,04	4.539,27
1.950,0	1.999,0	OF2021950W1E	2.593,03	2.593,03	4.361,30	2816,94	2.816,94	4.585,18	2.882,00	2.882,00	4.650,24
2.000,0	2.032,0	OF2022000W1E	2.644,73	2.644,72	4.456,98	2883,92	2.883,92	4.694,27	2.948,99	2.948,99	4.759,33

 Código W1 en NBR termina W1N
 Código W1 en FKM termina W1F

 Código W2 en EPDM termina W2E
 Código W2 en NBR termina W2N
 Código W2 en FKM termina W2F

 Código W5 en EPDM termina W5E
 Código W5 en NBR termina W5N
 Código W5 en FKM termina W5F

(1) acoplamiento con anillo interior en acero inoxidable incorporado

En caso de pedido indicar el diámetro exterior exacto

Junta: EPDM: -20°C hasta +100°C NBR: -20°C hasta +80°C FKM: -20°C hasta +180°C

Fluido: EPDM: Todas las calidades de agua, aguas residuales, aire, sólidos y diversos productos químicos

NBR: Agua, gas, aceite, combustible y otros hidrocarburos

FKM: Ozono, oxígeno, ácidos, gas, aceite y carburantes

Especificar 1 o 2 cierres

OPEN FLEX 2 PN 6

J1

desde Ø exterior	hasta Ø exterior	Ref. EPDM	W1 CARCASA GALVANIZADA. CIERRES GALVANIZADOS			W2 CARCASA EN ACERO INOX. CIERRES GALVANIZADOS			W5 CARCASA EN ACERO INOX. CIERRES EN ACERO INOX.		
			€ EPDM	€ NBR	€ FKM (1)	€ EPDM	€ NBR	€ FKM (1)	€ EPDM	€ NBR	€ FKM (1)
172,0	199,0					443,98	443,98	595,16	505,21	505,21	656,40
200,0	224,0					459,29	459,29	635,35	520,53	520,53	696,58
225,0	249,0					468,86	468,86	675,53	530,10	530,10	736,77
250,0	274,0					482,24	482,24	717,65	543,48	543,48	778,85
275,0	299,0	OF2060275W1E	926,22	926,22	1.167,34	493,75	493,75	761,65	554,99	554,99	822,89
300,0	324,0	OF2060300W1E	941,51	941,51	1.217,11	509,04	509,04	801,84	570,28	570,28	863,07
325,0	349,0	OF2060325W1E	958,75	958,75	1.266,84	518,60	518,60	843,92	579,84	579,84	905,16
350,0	374,0	OF2060350W1E	974,05	974,05	1.312,79	533,92	533,92	889,86	595,16	595,16	951,10
375,0	399,0	OF2060375W1E	991,29	991,29	1.366,37	543,48	543,48	928,14	604,72	604,72	989,38
400,0	424,0	OF2060400W1E	1.006,58	1.006,58	1.416,14	553,06	553,06	970,22	614,29	614,29	1.031,46
425,0	449,0	OF2060425W1E	1.025,74	1.025,74	1.460,14	574,11	574,11	1.016,17	635,35	635,35	1.077,40
450,0	474,0	OF2060450W1E	1.041,03	1.041,04	1.506,08	585,60	585,60	1.056,35	646,83	646,83	1.117,59
475,0	499,0	OF2060475W1E	1.056,35	1.056,35	1.550,08	602,82	602,82	1.100,36	664,06	664,06	1.161,59
500,0	524,0	OF2060500W1E	1.071,64	1.071,65	1.596,03	618,12	618,12	1.142,47	679,36	679,36	1.203,71
525,0	549,0	OF2060525W1E	1.094,64	1.094,64	1.645,76	687,01	687,01	1.247,72	748,25	748,25	1.308,96
550,0	574,0	OF2060550W1E	1.125,25	1.125,25	1.708,92	704,24	704,24	1.291,73	765,48	765,48	1.352,96
575,0	599,0	OF2060575W1E	1.148,22	1.148,22	1.760,59	721,47	721,47	1.333,84	782,71	782,71	1.395,08
600,0	624,0	OF2060600W1E	1.217,12	1.217,11	1.827,58	966,39	966,39	1.576,87	1.031,46	1.031,46	1.641,93
625,0	649,0	OF2060625W1E	1.240,07	1.240,07	1.886,90	993,21	993,21	1.640,04	1.058,27	1.058,27	1.705,09
650,0	674,0	OF2060650W1E	1.266,84	1.266,84	1.942,39	1.016,17	1.016,17	1.691,70	1.081,23	1.081,23	1.756,77
675,0	699,0	OF2060675W1E	1.291,72	1.291,73	1.990,25	1.046,80	1.046,80	1.747,19	1.111,86	1.111,86	1.812,26
700,0	724,0	OF2060700W1E	1.318,54	1.318,54	2.045,73	1.067,82	1.067,82	1.795,05	1.132,88	1.132,88	1.860,12
725,0	749,0	OF2060725W1E	1.343,42	1.343,42	2.097,39	1.098,46	1.098,46	1.850,53	1.163,52	1.163,52	1.915,60
750,0	799,0	OF2060750W1E	1.364,45	1.364,45	2.128,02	1.299,38	1.299,38	1.969,19	1.364,45	1.364,45	2.034,25
800,0	849,0	OF2060800W1E	1.419,95	1.419,95	2.191,17	1.345,32	1.345,32	2.074,44	1.410,38	1.410,38	2.139,51

Acoplamiento abierto para tubos de cualquier material sin anclaje axial.
Abierto con bisagra.

Código W1 en NBR termina W1N
Código W1 en FKM termina W1F

Código W2 en EPDM termina W2E
Código W2 en NBR termina W2N
Código W2 en FKM termina W2F

Código W5 en EPDM termina W5E
Código W5 en NBR termina W5N
Código W5 en FKM termina W5F

Continúa en la página siguiente...

J1

desde Ø exterior	hasta Ø exterior	Ref. EPDM	W1 CARCASA GALVANIZADA. CIERRES GALVANIZADOS			W2 CARCASA EN ACERO INOX. CIERRES GALVANIZADOS			W5 CARCASA EN ACERO INOX. CIERRES EN ACERO INOX.		
			€ EPDM	€ NBR	€ FKM (1)	€ EPDM	€ NBR	€ FKM (1)	€ EPDM	€ NBR	€ FKM (1)
850,0	899,0	OF2060850W1E	1.469,72	1.469,72	2.252,40	1.393,15	1.393,15	2.175,86	1.458,21	1.458,21	2.240,93
900,0	949,0	OF2060900W1E	1.519,45	1.519,45	2.355,76	1.444,84	1.444,84	2.281,10	1.509,91	1.509,91	2.346,17
950,0	999,0	OF2060950W1E	1.571,14	1.571,14	2.464,84	1.492,67	1.492,67	2.384,46	1.557,74	1.557,74	2.449,52
1.000,0	1.049,0	OF2061000W1E	1.620,89	1.620,89	2.566,25	1.540,50	1.540,50	2.487,79	1.605,57	1.605,57	2.552,85
1.050,0	1.099,0	OF2061050W1E	1.678,30	1.678,29	2.667,67	1.605,57	1.605,57	2.596,86	1.670,64	1.670,64	2.661,92
1.100,0	1.149,0	OF2061100W1E	1.722,31	1.722,31	2.751,87	1.678,29	1.678,29	2.705,96	1.743,36	1.743,36	2.771,02
1.150,0	1.199,0	OF2061150W1E	1.773,99	1.773,99	2.845,64	1.745,28	1.745,28	2.816,94	1.810,35	1.810,35	2.882,00
1.200,0	1.249,0	OF2061200W1E	1.825,66	1.825,66	2.941,34				2.509,36	2.509,36	4.576,24
1.250,0	1.299,0	OF2061250W1E	1.877,32	1.877,32	3.035,12				2.570,08	2.570,08	4.710,73
1.300,0	1.349,0	OF2061300W1E	1.927,08	1.927,07	3.130,78				2.630,79	2.630,79	4.845,20
1.350,0	1.399,0	OF2061350W1E	1.978,74	1.978,74	3.224,56				2.693,70	2.693,70	4.981,84
1.400,0	1.449,0	OF2061400W1E	2.030,42	2.030,43	3.322,15				2.758,76	2.758,76	5.118,48
1.450,0	1.499,0	OF2061450W1E	2.082,10	2.082,10	3.415,93				2.825,99	2.825,99	5.257,27
1.500,0	1.549,0	OF2061500W1E	2.131,84	2.131,85	3.509,70				2.893,25	2.893,25	5.400,42
1.550,0	1.600,0	OF2061550W1E	2.183,51	2.183,51	3.605,37				2.962,63	2.962,63	5.539,21
1.600,0	1.649,0	OF2061600W1E	2.235,18	2.235,18	3.699,14				3.034,20	3.034,20	5.684,54
1.650,0	1.699,0	OF2061650W1E	2.286,87	2.286,86	3.794,84				3.107,96	3.107,96	5.832,01
1.700,0	1.749,0	OF2061700W1E	2.338,52	2.338,52	3.888,61				3.366,03	3.366,03	6.163,84
1.750,0	1.799,0	OF2061750W1E	2.388,28	2.388,28	3.984,29				3.450,63	3.450,63	6.320,00
1.800,0	1.849,0	OF2061800W1E	2.439,95	2.439,95	4.078,06				3.535,21	3.535,21	6.478,34
1.850,0	1.899,0	OF2061850W1E	2.491,61	2.491,62	4.173,76				3.626,30	3.626,30	6.638,82
1.900,0	1.949,0	OF2061900W1E	3.249,44	3.249,44	4.975,56				3.715,22	3.715,22	6.803,67
1.950,0	1.999,0	OF2061950W1E	3.314,51	3.314,50	5.082,75				3.808,47	3.808,47	6.970,65
2.000,0	2.032,0	OF2062000W1E	3.379,57	3.379,57	5.191,83				3.903,92	3.903,92	7.137,65

Código W1 en NBR termina W1N
 Código W1 en FKM termina W1F

Código W2 en EPDM termina W2E
 Código W2 en NBR termina W2N
 Código W2 en FKM termina W2F

Código W5 en EPDM termina W5E
 Código W5 en NBR termina W5N
 Código W5 en FKM termina W5F

(1) acoplamiento con anillo interior en acero inoxidable incorporado

En caso de pedido indicar el diámetro exterior exacto

Junta: EPDM: -20°C hasta +100°C NBR: -20°C hasta +80°C FKM: -20°C hasta +180°C

Fluido: EPDM: Todas las calidades de agua, aguas residuales, aire, sólidos y diversos productos químicos

NBR: Agua, gas, aceite, combustible y otros hidrocarburos

FKM: Ozono, oxígeno, ácidos, gas, aceite y carburantes

Especificar 1 o 2 cierres

OPEN FLEX 2 PN 10

J1

desde Ø exterior	hasta Ø exterior	Ref. EPDM	W1 CARCASA GALVANIZADA. CIERRES GALVANIZADOS			W2 CARCASA EN ACERO INOX. CIERRES GALVANIZADOS			W5 CARCASA EN ACERO INOX. CIERRES EN ACERO INOX.		
			€ EPDM	€ NBR	€ FKM (1)	€ EPDM	€ NBR	€ FKM (1)	€ EPDM	€ NBR	€ FKM (1)
172,0	199,0					443,98	443,98	595,16	505,21	505,21	656,40
200,0	224,0					459,29	459,29	635,35	520,53	520,53	696,58
225,0	249,0					468,86	468,86	675,53	530,10	530,10	736,77
250,0	274,0					482,24	482,24	717,65	543,48	543,48	778,85
275,0	299,0	OF2100275W1E	926,22	926,22	1.167,34	531,99	531,99	807,56	593,23	593,23	868,81
300,0	324,0	OF2100300W1E	941,51	941,51	1.217,11	549,23	549,23	855,43	610,47	610,47	916,66
325,0	349,0	OF2100325W1E	958,75	958,75	1.266,84	560,70	560,70	895,61	621,94	621,94	956,85
350,0	374,0	OF2100350W1E	974,05	974,05	1.312,79	721,47	721,47	1.060,18	786,53	786,53	1.125,25
375,0	399,0	OF2100375W1E	991,29	991,29	1.366,37	734,85	734,85	1.109,93	799,92	799,92	1.175,00
400,0	424,0	OF2100400W1E	1.006,58	1.006,58	1.416,14	748,25	748,25	1.157,76	813,31	813,31	1.222,83
425,0	449,0	OF2100425W1E	1.025,74	1.025,74	1.460,14	773,14	773,14	1.207,54	838,20	838,20	1.272,60
450,0	474,0	OF2100450W1E	1.041,03	1.041,04	1.506,08	790,36	790,36	1.255,37	855,43	855,43	1.320,44
475,0	499,0	OF2100475W1E	1.056,35	1.056,35	1.550,08	815,24	815,24	1.308,96	880,30	880,30	1.374,03
500,0	524,0	OF2100500W1E	1.071,64	1.071,65	1.596,03	836,27	836,27	1.360,62	901,34	901,34	1.425,69
525,0	549,0	OF2100525W1E	1.094,64	1.094,64	1.645,76	861,15	861,15	1.414,20	926,22	926,22	1.479,27
550,0	574,0	OF2100550W1E	1.125,25	1.125,25	1.708,92	882,21	882,21	1.465,89	947,27	947,27	1.530,96
575,0	599,0	OF2100575W1E	1.148,22	1.148,22	1.760,59	903,27	903,27	1.513,72	968,34	968,34	1.578,79
600,0	624,0	OF2100600W1E	1.217,12	1.217,11	1.827,58	966,39	966,39	1.576,87	1.031,46	1.031,46	1.641,93
625,0	649,0	OF2100625W1E	1.240,07	1.240,07	1.886,90	993,21	993,21	1.640,04	1.058,27	1.058,27	1.705,09
650,0	674,0	OF2100650W1E	1.266,84	1.266,84	1.942,39	1.016,17	1.016,17	1.691,70	1.081,23	1.081,23	1.756,77
675,0	699,0	OF2100675W1E	1.291,72	1.291,73	1.990,25	1.046,80	1.046,80	1.747,19	1.111,86	1.111,86	1.812,26
700,0	724,0	OF2100700W1E	1.318,54	1.318,54	2.045,73	1.067,82	1.067,82	1.795,05	1.132,88	1.132,88	1.860,12
725,0	749,0	OF2100725W1E	1.343,42	1.343,42	2.097,39				2.099,45	2.099,45	3.439,79
750,0	799,0	OF2100750W1E	1.364,45	1.364,45	2.128,02				2.134,14	2.134,14	3.546,05
800,0	849,0	OF2100800W1E	1.419,95	1.419,95	2.191,17				2.166,68	2.166,68	3.652,31

Acoplamiento abierto para tubos de cualquier material sin anclaje axial.
Abierto con bisagra.

Código W1 en NBR termina W1N
Código W1 en FKM termina W1F

Código W2 en EPDM termina W2E
Código W2 en NBR termina W2N
Código W2 en FKM termina W2F

Código W5 en EPDM termina W5E
Código W5 en NBR termina W5N
Código W5 en FKM termina W5F

Continúa en la página siguiente...

J1

desde Ø exterior	hasta Ø exterior	Ref. EPDM	W1 CARCASA GALVANIZADA. CIERRES GALVANIZADOS			W2 CARCASA EN ACERO INOX. CIERRES GALVANIZADOS			W5 CARCASA EN ACERO INOX. CIERRES EN ACERO INOX.		
			€ EPDM	€ NBR	€ FKM (1)	€ EPDM	€ NBR	€ FKM (1)	€ EPDM	€ NBR	€ FKM (1)
850,0	899,0	OF2100850W1E	1.469,72	1.469,72	2.252,40				2.192,70	2.192,70	3.752,11
900,0	949,0	OF2100900W1E	1.519,45	1.519,45	2.355,76				2.238,25	2.238,25	3.869,22
950,0	999,0	OF2100950W1E	1.571,14	1.571,14	2.464,84				2.268,61	2.268,61	3.973,33
1.000,0	1.049,0	OF2101000W1E	2.078,27	2.078,27	3.023,61				2.298,97	2.298,97	4.077,43
1.050,0	1.099,0	OF2101050W1E	2.150,98	2.150,98	3.140,36				2.329,34	2.329,34	4.179,36
1.100,0	1.149,0	OF2101100W1E	2.210,28	2.210,29	3.237,95				2.392,24	2.392,24	4.315,98
1.150,0	1.199,0	OF2101150W1E	2.275,35	2.275,35	3.347,04				2.455,12	2.455,12	4.452,62
1.200,0	1.249,0	OF2101200W1E	2.340,42	2.340,42	3.456,11						
1.250,0	1.299,0	OF2101250W1E	2.405,48	2.405,49	3.563,28						
1.300,0	1.349,0	OF2101300W1E	2.470,55	2.470,55	3.672,35						
1.350,0	1.399,0	OF2101350W1E	2.535,62	2.535,62	3.781,43						
1.400,0	1.449,0	OF2101400W1E	2.600,68	2.600,69	3.890,51						
1.450,0	1.499,0	OF2101450W1E	2.665,75	2.665,75	3.999,59						
1.500,0	1.549,0	OF2101500W1E	2.730,82	2.730,82	4.108,69						
1.550,0	1.600,0	OF2101550W1E	2.795,88	2.795,88	4.215,83						
1.600,0	1.649,0	OF2101600W1E	2.860,95	2.860,95	4.324,91						
1.650,0	1.699,0	OF2101650W1E	2.926,01	2.926,02	4.432,09						
1.700,0	1.749,0	OF2101700W1E	2.991,08	2.991,08	4.541,16						
1.750,0	1.799,0	OF2101750W1E	3.056,15	3.056,15	4.650,24						
1.800,0	1.849,0	OF2101800W1E	3.119,31	3.119,31	4.757,42						
1.850,0	1.899,0	OF2101850W1E	3.184,37	3.184,37	4.866,50						
1.900,0	1.949,0	OF2101900W1E	3.249,44	3.249,44	4.975,56						
1.950,0	1.999,0	OF2101950W1E	3.314,51	3.314,50	5.082,75						
2.000,0	2.032,0	OF2102000W1E	3.379,57	3.379,57	5.191,83						

Código W1 en NBR termina W1N
 Código W1 en FKM termina W1F

Código W5 en EPDM termina W5E
 Código W5 en NBR termina W5N
 Código W5 en FKM termina W5F

(1) acoplamiento con anillo interior en acero inoxidable incorporado

En caso de pedido indicar el diámetro exterior exacto

Junta: EPDM: -20°C hasta +100°C NBR: -20°C hasta +80°C FKM: -20°C hasta +180°C

Fluido: EPDM: Todas las calidades de agua, aguas residuales, aire, sólidos y diversos productos químicos

NBR: Agua, gas, aceite, combustible y otros hidrocarburos

FKM: Ozono, oxígeno, ácidos, gas, aceite y carburantes

Especificar 1 o 2 cierres



OPEN FLEX 2 PN 16

J1

desde Ø exterior	hasta Ø exterior	Ref. EPDM	W1 CARCASA GALVANIZADA. CIERRES GALVANIZADOS			W2 CARCASA EN ACERO INOX. CIERRES GALVANIZADOS			W5 CARCASA EN ACERO INOX. CIERRES EN ACERO INOX.		
			€ EPDM	€ NBR	€ FKM (1)	€ EPDM	€ NBR	€ FKM (1)	€ EPDM	€ NBR	€ FKM (1)
180,0	199,0					478,41	478,41	641,07	539,65	539,65	702,31
200,0	224,0					495,64	495,64	679,36	556,88	556,88	740,60
225,0	249,0					633,43	633,43	807,56	698,49	698,49	872,63
250,0	274,0					650,66	650,66	857,33	715,72	715,72	922,39
275,0	299,0	OF2160275W1E	926,22	926,22	1.167,34	664,06	664,06	905,16	729,12	729,12	970,22
300,0	324,0	OF2160300W1E	941,51	941,51	1.217,11	685,12	685,12	960,68	750,19	750,19	1.025,74
325,0	349,0	OF2160325W1E	958,75	958,75	1.266,84	700,41	700,41	1.008,51	765,48	765,48	1.073,58
350,0	374,0	OF2160350W1E	974,05	974,05	1.312,79	721,47	721,47	1.060,18	786,53	786,53	1.125,25
375,0	399,0	OF2160375W1E	991,29	991,29	1.366,37	734,85	734,85	1.109,93	799,92	799,92	1.175,00
400,0	424,0	OF2160400W1E	1.006,58	1.006,58	1.416,14	748,25	748,25	1.157,76	813,31	813,31	1.222,83
425,0	449,0	OF2160425W1E	1.025,74	1.025,74	1.460,14				1.917,26	1.917,26	2.821,67
450,0	474,0	OF2160450W1E	1.041,03	1.041,04	1.506,08				1.932,44	1.932,44	2.871,54
475,0	499,0	OF2160475W1E	1.056,35	1.056,35	1.550,08				1.943,29	1.943,29	2.919,28
500,0	524,0	OF2160500W1E	1.071,64	1.071,65	1.596,03				1.958,46	1.958,46	2.971,32
525,0	549,0	OF2160525W1E	1.094,64	1.094,64	1.645,76				1.971,48	1.971,48	3.021,19
550,0	574,0	OF2160550W1E	1.125,25	1.125,25	1.708,92				1.986,65	1.986,65	3.071,07
575,0	599,0	OF2160575W1E	1.148,22	1.148,22	1.760,59				1.999,67	1.999,67	3.120,98
600,0	624,0	OF2160600W1E	1.217,12	1.217,11	1.827,58				2.023,52	2.023,52	3.181,69
625,0	649,0	OF2160625W1E	1.590,28	1.590,28	2.237,10				2.036,55	2.036,55	3.231,58
650,0	674,0	OF2160650W1E	1.626,63	1.626,63	2.300,25				2.051,72	2.051,72	3.281,45
675,0	699,0	OF2160675W1E	1.655,35	1.655,34	2.355,76				2.064,72	2.064,72	3.333,50
700,0	724,0	OF2160700W1E	1.689,77	1.689,77	2.416,99				2.077,74	2.077,74	3.381,23
725,0	749,0	OF2160725W1E	1.722,31	1.722,31	2.476,30				2.099,45	2.099,45	3.439,79
750,0	799,0	OF2160750W1E	1.749,11	1.749,11	2.514,59				2.134,14	2.134,14	3.546,05
800,0	849,0	OF2160800W1E	1.821,83	1.821,83	2.591,14				2.166,68	2.166,68	3.652,31
850,0	899,0	OF2160850W1E	1.886,90	1.886,90	2.669,60						
900,0	949,0	OF2160900W1E	1.950,03	1.950,02	2.784,40						
950,0	999,0	OF2160950W1E	2.015,09	2.015,09	2.906,87						
1.000,0	1.049,0	OF2161000W1E	2.078,27	2.078,27	3.023,61						
1.050,0	1.099,0	OF2161050W1E	2.150,98	2.150,98	3.140,36						
1.100,0	1.149,0	OF2161100W1E	2.210,28	2.210,29	3.237,95						
1.150,0	1.199,0	OF2161150W1E	2.275,35	2.275,35	3.347,04						
1.200,0	1.249,0	OF2161200W1E	2.340,42	2.340,42	3.456,11						
1.250,0	1.299,0	OF2161250W1E	2.405,48	2.405,49	3.563,28						
1.300,0	1.349,0	OF2161300W1E	2.470,55	2.470,55	3.672,35						
1.350,0	1.399,0	OF2161350W1E	2.535,62	2.535,62	3.781,43						
1.400,0	1.449,0	OF2161400W1E	2.600,68	2.600,69	3.890,51						
1.450,0	1.499,0	OF2161450W1E	2.665,75	2.665,75	3.999,59						

Acoplamiento abierto para tubos de cualquier material sin anclaje axial.

Abierto con bisagra.

Código W1 en NBR termina W1N
Código W1 en FKM termina W1F

Código W2 en EPDM termina W2E
Código W2 en NBR termina W2N
Código W2 en FKM termina W2F

Código W5 en EPDM termina W5E
Código W5 en NBR termina W5N
Código W5 en FKM termina W5F

(1) acoplamiento con anillo interior en acero inoxidable incorporado

En caso de pedido indicar el diámetro exterior exacto

Junta: EPDM: -20°C hasta +100°C NBR: -20°C hasta +80°C FKM: -20°C hasta +180°C

Fluido: EPDM: Todas las calidades de agua, aguas residuales, aire, sólidos y diversos productos químicos

NBR: Agua, gas, aceite, combustible y otros hidrocarburos

FKM: Ozono, oxígeno, ácidos, gas, aceite y carburantes

Especificar 1 o 2 cierres

OPEN FLEX 2 PN 20

J1

desde Ø exterior	hasta Ø exterior	Ref. EPDM	W1 CARCASA GALVANIZADA. CIERRES GALVANIZADOS			W2 CARCASA EN ACERO INOX. CIERRES GALVANIZADOS			W5 CARCASA EN ACERO INOX. CIERRES EN ACERO INOX.		
			€ EPDM	€ NBR	€ FKM (1)	€ EPDM	€ NBR	€ FKM (1)	€ EPDM	€ NBR	€ FKM (1)
180,0	199,0					604,72	604,72	721,47	669,78	669,78	786,53
200,0	224,0					618,12	618,12	761,65	683,19	683,19	826,72
225,0	249,0					633,43	633,43	807,56	698,49	698,49	872,63
250,0	274,0					650,66	650,66	857,33	715,72	715,72	922,39
275,0	299,0	OF2200275W1E	926,22	926,22	1.167,34	664,06	664,06	905,16	729,12	729,12	970,22
300,0	324,0	OF2200300W1E	941,51	941,51	1.217,11	685,12	685,12	960,68	750,19	750,19	1.025,74
325,0	349,0	OF2200325W1E	958,75	958,75	1.266,84				1.858,70	1.858,70	2.615,63
350,0	374,0	OF2200350W1E	974,05	974,05	1.312,79				1.869,53	1.869,53	2.665,51
375,0	399,0	OF2200375W1E	991,29	991,29	1.366,37				1.889,06	1.889,06	2.721,90
400,0	424,0	OF2200400W1E	1.006,58	1.006,58	1.416,14				1.904,25	1.904,25	2.769,63
425,0	449,0	OF2200425W1E	1.025,74	1.025,74	1.460,14				1.917,26	1.917,26	2.821,67
450,0	474,0	OF2200450W1E	1.041,03	1.041,04	1.506,08				1.932,44	1.932,44	2.871,54
475,0	499,0	OF2200475W1E	1.354,89	1.354,89	1.846,71				1.943,29	1.943,29	2.919,28
500,0	524,0	OF2200500W1E	1.374,03	1.374,03	1.898,36				1.958,46	1.958,46	2.971,32
525,0	549,0	OF2200525W1E	1.400,82	1.400,83	1.953,88				1.971,48	1.971,48	3.021,19
550,0	574,0	OF2200550W1E	1.442,92	1.442,92	2.026,60				1.986,65	1.986,65	3.071,07
575,0	599,0	OF2200575W1E	1.471,62	1.471,62	2.084,02				1.999,67	1.999,67	3.120,98
600,0	624,0	OF2200600W1E	1.559,65	1.559,65	2.170,11				2.023,52	2.023,52	3.181,69
625,0	649,0	OF2200625W1E	1.590,28	1.590,28	2.237,10				2.036,55	2.036,55	3.231,58
650,0	674,0	OF2200650W1E	1.626,63	1.626,63	2.300,25						
675,0	699,0	OF2200675W1E	1.655,35	1.655,34	2.355,76						
700,0	724,0	OF2200700W1E	1.689,77	1.689,77	2.416,99						
725,0	749,0	OF2200725W1E	1.722,31	1.722,31	2.476,30						
750,0	799,0	OF2200750W1E	1.749,11	1.749,11	2.514,59						
800,0	849,0	OF2200800W1E	1.821,83	1.821,83	2.591,14						
850,0	899,0	OF2200850W1E	1.886,90	1.886,90	2.669,60						
900,0	949,0	OF2200900W1E	1.950,03	1.950,02	2.784,40						
950,0	999,0	OF2200950W1E	2.015,09	2.015,09	2.906,87						

Acoplamiento abierto para tubos de cualquier material sin anclaje axial.

Abierto con bisagra.

Código W1 en NBR termina W1N
Código W1 en FKM termina W1F

Código W2 en EPDM termina W2E
Código W2 en NBR termina W2N
Código W2 en FKM termina W2F

Código W5 en EPDM termina W5E
Código W5 en NBR termina W5N
Código W5 en FKM termina W5F

(1) acoplamiento con anillo interior en acero inoxidable incorporado

En caso de pedido indicar el diámetro exterior exacto

Junta: EPDM: -20°C hasta +100°C NBR: -20°C hasta +80°C FKM: -20°C hasta +180°C

Fluido: EPDM: Todas las calidades de agua, aguas residuales, aire, sólidos y diversos productos químicos

NBR: Agua, gas, aceite, combustible y otros hidrocarburos

FKM: Ozono, oxígeno, ácidos, gas, aceite y carburantes

Especificar 1 o 2 cierres

OPEN FLEX 2 PN 25

J1

desde Ø exterior	hasta Ø exterior	Ref. EPDM	W1 CARCASA GALVANIZADA. CIERRES GALVANIZADOS			W2 CARCASA EN ACERO INOX. CIERRES GALVANIZADOS			W5 CARCASA EN ACERO INOX. CIERRES EN ACERO INOX.		
			€ EPDM	€ NBR	€ FKM (1)	€ EPDM	€ NBR	€ FKM (1)	€ EPDM	€ NBR	€ FKM (1)
180,0	199,0					604,72	604,72	721,47	669,78	669,78	786,53
200,0	224,0					618,12	618,12	761,65	683,19	683,19	826,72
225,0	249,0					633,43	633,43	807,56	698,49	698,49	872,63
250,0	274,0					650,66	650,66	857,33	715,72	715,72	922,39
275,0	299,0	OF2250275W1E	857,61	926,22	1.167,34				1.830,49	1.830,49	2.515,86
300,0	324,0	OF2250300W1E	941,51	941,51	1.217,11				1.843,51	1.843,51	2.563,57
325,0	349,0	OF2250325W1E	958,75	958,75	1.266,84				1.858,70	1.858,70	2.615,63
350,0	374,0	OF2250350W1E	1.247,72	1.247,72	1.586,45				1.869,53	1.869,53	2.665,51
375,0	399,0	OF2250375W1E	1.270,70	1.270,69	1.645,76				1.889,06	1.889,06	2.721,90
400,0	424,0	OF2250400W1E	1.291,72	1.291,73	1.699,36				1.904,25	1.904,25	2.769,63
425,0	449,0	OF2250425W1E	1.314,71	1.314,71	1.751,02				1.917,26	1.917,26	2.821,67
450,0	474,0	OF2250450W1E	1.333,84	1.333,84	1.798,88				1.932,44	1.932,44	2.871,54
475,0	499,0	OF2250475W1E	1.354,89	1.354,89	1.846,71				1.943,29	1.943,29	2.919,28
500,0	524,0	OF2250500W1E	1.374,03	1.374,03	1.898,36				1.958,46	1.958,46	2.971,32
525,0	549,0	OF2250525W1E	1.400,82	1.400,83	1.953,88						
550,0	574,0	OF2250550W1E	1.442,92	1.442,92	2.026,60						
575,0	599,0	OF2250575W1E	1.471,62	1.471,62	2.084,02						
600,0	624,0	OF2250600W1E	1.559,65	1.559,65	2.170,11						
625,0	649,0	OF2250625W1E	1.590,28	1.590,28	2.237,10						
650,0	674,0	OF2250650W1E	1.626,63	1.626,63	2.300,25						
675,0	699,0	OF2250675W1E	1.655,35	1.655,34	2.355,76						
700,0	724,0	OF2250700W1E	1.689,77	1.689,77	2.416,99						
725,0	749,0	OF2250725W1E	1.722,31	1.722,31	2.476,30						

Acoplamiento abierto para tubos de cualquier material sin anclaje axial.

Abierto con bisagra.

Código W1 en NBR termina W1N
Código W1 en FKM termina W1F

Código W2 en EPDM termina W2E
Código W2 en NBR termina W2N
Código W2 en FKM termina W2F

Código W5 en EPDM termina W5E
Código W5 en NBR termina W5N
Código W5 en FKM termina W5F

(1) acoplamiento con anillo interior en acero inoxidable incorporado

En caso de pedido indicar el diámetro exterior exacto

Junta: EPDM: -20°C hasta +100°C NBR: -20°C hasta +80°C FKM: -20°C hasta +180°C

Fluido: EPDM: Todas las calidades de agua, aguas residuales, aire, sólidos y diversos productos químicos

NBR: Agua, gas, aceite, combustible y otros hidrocarburos

FKM: Ozono, oxígeno, ácidos, gas, aceite y carburantes

Especificar 1 o 2 cierres

OPEN FLEX 3 PN 2,5

J1

desde Ø exterior	hasta Ø exterior	Ref. EPDM	W1 CARCASA GALVANIZADA. CIERRES GALVANIZADOS		W2 CARCASA EN ACERO INOX. CIERRES GALVANIZADOS		W5 CARCASA EN ACERO INOX. CIERRES EN ACERO INOX.	
			€ EPDM	€ NBR	€ EPDM	€ NBR	€ EPDM	€ NBR
219,1	249,0				1.217,11	1.546,26	1.362,54	1.691,70
250,0	299,0				1.264,95	1.605,57	1.410,38	1.751,02
300,0	349,0	OF3020300W1E	1.502,25	1.936,65	1.345,32	1.708,92	1.490,75	1.854,36
350,0	399,0	OF3020350W1E	1.557,74	2.009,37	1.427,61	1.812,26	1.573,04	1.957,71
400,0	449,0	OF3020400W1E	1.613,23	2.080,16	1.507,99	1.915,60	1.653,41	2.061,03
450,0	499,0	OF3020450W1E	1.666,82	2.150,98	1.588,35	2.018,95	1.733,82	2.164,39
500,0	549,0	OF3020500W1E	1.722,31	2.221,80	1.668,75	2.120,37	1.814,17	2.265,81
550,0	599,0	OF3020550W1E	1.777,82	2.294,52	1.751,02	2.223,69	1.896,46	2.369,13
600,0	649,0	OF3020600W1E	1.833,30	2.365,30	1.831,41	2.325,13	1.976,85	2.470,55
650,0	699,0	OF3020650W1E	1.890,72	2.438,03	1.907,95	2.422,72	2.053,38	2.568,15
700,0	749,0	OF3020700W1E	1.940,48	2.501,18	1.986,42	2.522,25	2.131,85	2.667,67
750,0	799,0	OF3020750W1E	1.997,89	2.577,73	2.070,61	2.629,40	2.216,04	2.774,85
800,0	849,0	OF3020800W1E	2.055,30	2.650,45	2.149,08	2.728,91	2.294,52	2.874,36
850,0	899,0	OF3020850W1E	2.118,44	2.734,67	2.227,52	2.828,41	2.372,96	2.973,88
900,0	949,0	OF3020900W1E	2.185,43	2.820,77	2.305,98	2.929,87	2.451,43	3.075,29
950,0	999,0	OF3020950W1E	2.250,49	2.903,06	2.386,36	3.031,29	2.531,79	3.176,72
1.000,0	1.049,0	OF3021000W1E	2.317,47	2.991,08	2.459,08	3.125,07	2.604,54	3.270,49
1.050,0	1.099,0	OF3021050W1E	2.386,37	3.079,12	2.543,30	3.228,38	2.688,72	3.373,82
1.100,0	1.149,0	OF3021100W1E	2.449,53	3.159,49	2.619,84	3.327,90	2.765,28	3.473,35
1.150,0	1.199,0	OF3021150W1E	2.505,01	3.232,20	2.700,21	3.429,32	2.845,64	3.574,77
1.200,0	1.249,0	OF3021200W1E	2.581,57	3.331,73	2.805,46	3.561,36	2.950,89	3.706,79
1.250,0	1.299,0	OF3021250W1E	2.663,84	3.435,06	2.908,81	3.695,32	3.054,24	3.840,77
1.300,0	1.349,0	OF3021300W1E	2.740,39	3.534,58	3.014,05	3.827,38	3.159,49	3.972,80
1.350,0	1.399,0	OF3021350W1E	2.820,77	3.637,89	3.117,39	3.959,40	3.262,83	4.104,87
1.400,0	1.449,0	OF3021400W1E	2.897,33	3.737,42	3.222,66	4.091,46	3.368,08	4.236,90
1.450,0	1.499,0	OF3021450W1E	2.973,88	3.836,92	3.327,90	4.225,41	3.473,35	4.370,85
1.500,0	1.549,0	OF3021500W1E	3.056,15	3.942,19	3.431,23	4.357,45	3.576,66	4.502,90
1.550,0	1.599,0	OF3021550W1E	3.130,78	4.037,87	3.536,48	4.489,50	3.681,94	4.634,94
1.600,0	1.649,0	OF3021600W1E	3.199,67	4.127,82	3.639,84	4.623,46	3.785,26	4.768,89
1.650,0	1.699,0	OF3021650W1E	3.270,49	4.217,76	3.745,08	4.755,52	3.890,51	4.900,95
1.700,0	1.749,0	OF3021700W1E	3.337,46	4.305,78	3.850,33	4.887,55	3.995,76	5.032,98
1.750,0	1.799,0	OF3021750W1E	3.419,74	4.411,03	3.953,68	5.021,50	4.099,11	5.166,93
1.800,0	1.849,0	OF3021800W1E	3.505,87	4.523,96	4.058,92	5.153,56	4.204,37	5.298,99
1.850,0	1.899,0	OF3021850W1E	3.593,89	4.636,86	4.162,25	5.285,59	4.307,71	5.431,03
1.900,0	1.949,0	OF3021900W1E	3.681,94	4.749,77	4.267,53	5.421,47	4.412,96	5.566,91
1.950,0	1.999,0	OF3021950W1E	3.771,86	4.866,50	4.372,78	5.553,50	4.518,21	5.698,96
2.000,0	2.032,0	OF3022000W1E	3.863,72	4.983,24	4.476,10	5.685,56	4.621,57	5.831,00

Acoplamiento abierto para tubos de cualquier material sin anclaje axial.
Abierta con bisagra.

Código W1 en NBR termina W1N

Código W2 en EPDM termina W2E
Código W2 en NBR termina W2NCódigo W5 en EPDM termina W5E
Código W5 en NBR termina W5N

En caso de pedido indicar el diámetro exterior exacto

Junta: EPDM: -20°C hasta +100°C NBR: -20°C hasta +80°C

Fluido: EPDM: Todas las calidades de agua, aguas residuales, aire, sólidos y diversos productos químicos

NBR: Agua, gas, aceite, combustible y otros hidrocarburos

Especificación 1 o 2 cierres

OPEN FLEX 3 PN 6

J1

desde Ø exterior	hasta Ø exterior	Ref. EPDM	W1 CARCASA GALVANIZADA. CIERRES GALVANIZADOS		W2 CARCASA EN ACERO INOX. CIERRES GALVANIZADOS		W5 CARCASA EN ACERO INOX. CIERRES EN ACERO INOX.	
			€ EPDM	€ NBR	€ EPDM	€ NBR	€ EPDM	€ NBR
219,1	249,0				1.217,11	1.546,26	1.362,54	1.691,70
250,0	299,0				1.264,95	1.605,57	1.410,38	1.751,02
300,0	349,0	OF3060300W1E	1.502,25	1.936,65	1.345,32	1.708,92	1.490,75	1.854,36
350,0	399,0	OF3060350W1E	1.557,74	2.009,37	1.427,61	1.812,26	1.573,04	1.957,71
400,0	449,0	OF3060400W1E	1.613,23	2.080,16	1.507,99	1.915,60	1.653,41	2.061,03
450,0	499,0	OF3060450W1E	1.666,82	2.150,98	1.588,35	2.018,95	1.733,82	2.164,39
500,0	549,0	OF3060500W1E	1.722,31	2.221,80	1.668,75	2.120,37	1.814,17	2.265,81
550,0	599,0	OF3060550W1E	1.777,82	2.294,52	1.751,02	2.223,69	1.896,46	2.369,13
600,0	649,0	OF3060600W1E	1.833,30	2.365,30	1.831,41	2.325,13	1.976,85	2.470,55
650,0	699,0	OF3060650W1E	1.890,72	2.438,03	1.907,95	2.422,72	2.053,38	2.568,15
700,0	749,0	OF3060700W1E	1.940,48	2.501,18	1.986,42	2.522,25	2.131,85	2.667,67
750,0	799,0	OF3060750W1E	1.997,89	2.577,73	2.070,61	2.629,40	2.216,04	2.774,85
800,0	849,0	OF3060800W1E	2.055,30	2.650,45	2.149,08	2.728,91	2.294,52	2.874,36
850,0	899,0	OF3060850W1E	2.118,44	2.734,67	2.227,52	2.828,41	2.372,96	2.973,88
900,0	949,0	OF3060900W1E	2.185,43	2.820,77	2.305,98	2.929,87	2.451,43	3.075,29
950,0	999,0	OF3060950W1E	2.250,49	2.903,06	2.386,36	3.031,29	2.531,79	3.176,72
1.000,0	1.049,0	OF3061000W1E	2.317,47	2.991,08			3.370,38	3.546,05
1.050,0	1.099,0	OF3061050W1E	2.386,37	3.079,12			3.424,59	3.606,77
1.100,0	1.149,0	OF3061100W1E	2.449,53	3.159,49			3.476,65	3.667,52
1.150,0	1.199,0	OF3061150W1E	2.505,01	3.232,20			3.543,89	3.741,25
1.200,0	1.249,0	OF3061200W1E	2.581,57	3.331,73			3.606,77	3.814,99
1.250,0	1.299,0	OF3061250W1E	2.663,84	3.435,06			3.656,67	3.871,38
1.300,0	1.349,0	OF3061300W1E	2.740,39	3.534,58			3.721,73	3.945,12
1.350,0	1.399,0	OF3061350W1E	2.820,77	3.637,89			3.786,80	4.018,87
1.400,0	1.449,0	OF3061400W1E	2.897,33	3.737,42			3.847,51	4.086,09
1.450,0	1.499,0	OF3061450W1E	2.973,88	3.836,92			3.932,10	4.177,20
1.500,0	1.549,0	OF3061500W1E	3.056,15	3.942,19			4.012,38	4.266,13
1.550,0	1.599,0	OF3061550W1E	3.130,78	4.037,87			4.075,25	4.335,50
1.600,0	1.649,0	OF3061600W1E	3.199,67	4.127,82			4.142,49	4.411,42
1.650,0	1.699,0	OF3061650W1E	3.270,49	4.217,76			4.222,74	4.500,36
1.700,0	1.749,0	OF3061700W1E	3.337,46	4.305,78			4.302,98	4.589,27
1.750,0	1.799,0	OF3061750W1E	3.419,74	4.411,03			4.383,24	4.678,19
1.800,0	1.849,0	OF3061800W1E	3.505,87	4.523,96			4.704,22	5.007,86
1.850,0	1.899,0	OF3061850W1E	3.593,89	4.636,86			4.762,77	5.072,93
1.900,0	1.949,0	OF3061900W1E	3.681,94	4.749,77			4.819,18	5.138,00
1.950,0	1.999,0	OF3061950W1E	3.771,86	4.866,50			4.892,90	5.218,23
2.000,0	2.032,0	OF3062000W1E	3.863,72	4.983,24			4.973,15	5.307,17

Acoplamiento abierto para tubos de cualquier material sin anclaje axial.
Abierta con bisagra.

Código W1 en NBR termina W1N

Código W2 en EPDM termina W2E
Código W2 en NBR termina W2NCódigo W5 en EPDM termina W5E
Código W5 en NBR termina W5N

En caso de pedido indicar el diámetro exterior exacto

Junta: EPDM: -20°C hasta +100°C NBR: -20°C hasta +80°C

Fluido: EPDM: Todas las calidades de agua, aguas residuales, aire, sólidos y diversos productos químicos

NBR: Agua, gas, aceite, combustible y otros hidrocarburos

Especificar 1 o 2 cierres

OPEN FLEX 3 PN 10

J1

desde Ø exterior	hasta Ø exterior	Ref. EPDM	W1 CARCASA GALVANIZADA. CIERRES GALVANIZADOS		W2 CARCASA EN ACERO INOX. CIERRES GALVANIZADOS		W5 CARCASA EN ACERO INOX. CIERRES EN ACERO INOX.	
			€ EPDM	€ NBR	€ EPDM	€ NBR	€ EPDM	€ NBR
219,1	249,0				1.217,11	1.546,26	1.362,54	1.691,70
250,0	299,0				1.264,95	1.605,57	1.410,38	1.751,02
300,0	349,0	OF3100300W1E	1.502,25	1.936,65	1.345,32	1.708,92	1.490,75	1.854,36
350,0	399,0	OF3100350W1E	1.557,74	2.009,37	1.427,61	1.812,26	1.573,04	1.957,71
400,0	449,0	OF3100400W1E	1.613,23	2.080,16	1.507,99	1.915,60	1.653,41	2.061,03
450,0	499,0	OF3100450W1E	1.666,82	2.150,98	1.588,35	2.018,95	1.733,82	2.164,39
500,0	549,0	OF3100500W1E	1.722,31	2.221,80			2.652,50	2.743,59
525,0	549,0						2.693,70	2.789,14
550,0	599,0	OF3100550W1E	1.777,82	2.294,52			2.739,25	2.836,84
575,0	599,0						2.780,45	2.884,54
600,0	649,0	OF3100600W1E	1.833,30	2.365,30			2.843,36	2.956,12
650,0	699,0	OF3100650W1E	1.890,72	2.438,03			2.897,57	3.016,87
700,0	749,0	OF3100700W1E	1.940,48	2.501,18			2.949,61	3.075,42
750,0	799,0	OF3100750W1E	1.997,89	2.577,73			3.003,86	3.140,49
800,0	849,0	OF3100800W1E	2.055,30	2.650,45			3.060,23	3.203,36
850,0	899,0	OF3100850W1E	2.118,44	2.734,67			3.149,16	3.298,81
900,0	949,0	OF3100900W1E	2.185,43	2.820,77			3.235,90	3.398,56
950,0	999,0	OF3100950W1E	2.250,49	2.903,06			3.307,47	3.474,49
1.000,0	1.049,0	OF3101000W1E	2.317,47	2.991,08			3.370,38	3.546,05
1.050,0	1.099,0	OF3101050W1E	2.386,37	3.079,12			3.424,59	3.606,77
1.100,0	1.149,0	OF3101100W1E	2.449,53	3.159,49			3.476,65	3.667,52
1.150,0	1.199,0	OF3101150W1E	2.505,01	3.232,20			3.543,89	3.741,25
1.200,0	1.249,0	OF3101200W1E	2.581,57	3.331,73			3.606,77	3.814,99
1.250,0	1.299,0	OF3101250W1E	5.647,67	6.163,84			3.656,67	3.871,38
1.300,0	1.349,0	OF3101300W1E	5.730,09	6.254,93			3.721,73	3.945,12
1.350,0	1.399,0	OF3101350W1E	5.805,99	6.339,52			3.786,80	4.018,87
1.400,0	1.449,0	OF3101400W1E	5.888,41	6.432,79			3.847,51	4.086,09
1.450,0	1.499,0	OF3101450W1E	5.970,83	6.526,05			Consultar	Consultar
1.500,0	1.549,0	OF3101500W1E	6.048,90	6.612,79				
1.550,0	1.599,0	OF3101550W1E	6.129,15	6.703,88				
1.600,0	1.649,0	OF3101600W1E	6.207,24	6.790,66				
1.650,0	1.699,0	OF3101650W1E	6.289,65	6.881,74				
1.700,0	1.749,0	OF3101700W1E	6.367,72	6.970,65				
1.750,0	1.799,0	OF3101750W1E	6.450,13	7.061,74				
1.800,0	1.849,0	OF3101800W1E	6.526,05	7.148,51				
1.850,0	1.899,0	OF3101850W1E	6.608,47	7.239,61				
1.900,0	1.949,0	OF3101900W1E	6.686,55	7.326,36				
1.950,0	1.999,0	OF3101950W1E	6.768,94	7.419,60				
2.000,0	2.032,0	OF3102000W1E	6.844,87	7.504,18				

Acoplamiento abierto para tubos de cualquier material sin anclaje axial.

Abierto con bisagra.

Código W1 en NBR termina W1N

Código W2 en EPDM termina W2E
Código W2 en NBR termina W2N

Código W5 en EPDM termina W5E
Código W5 en NBR termina W5N

En caso de pedido indicar el diámetro exterior exacto

Junta: EPDM: -20°C hasta +100°C NBR: -20°C hasta +80°C

Fluido: EPDM: Todas las calidades de agua, aguas residuales, aire, sólidos y diversos productos químicos

NBR: Agua, gas, aceite, combustible y otros hidrocarburos

Especificar 1 o 2 cierres

OPEN FLEX 3 PN 16

J1

desde Ø exterior	hasta Ø exterior	Ref. EPDM	W1 CARCASA GALVANIZADA. CIERRES GALVANIZADOS		W2 CARCASA EN ACERO INOX. CIERRES GALVANIZADOS		W5 CARCASA EN ACERO INOX. CIERRES EN ACERO INOX.	
			€ EPDM	€ NBR	€ EPDM	€ NBR	€ EPDM	€ NBR
219,1	249,0				1.217,11	1.546,26	1.362,54	1.691,70
250,0	299,0				1.264,95	1.605,57	1.410,38	1.751,02
300,0	349,0	OF3160300W1E	1.502,25	1.936,65	1.345,32	1.708,92	1.490,75	1.854,36
350,0	399,0	OF3160350W1E	1.557,74	2.009,37			2.390,05	2.457,30
375,0	399,0			-			2.437,79	2.509,36
400,0	449,0	OF3160400W1E	1.613,23	2.080,16			2.478,98	2.554,90
425,0	449,0			-			2.522,37	2.602,61
450,0	499,0	OF3160450W1E	1.666,82	2.150,98			2.565,74	2.650,32
475,0	499,0			-			2.609,12	2.695,86
500,0	549,0	OF3160500W1E	1.722,31	2.221,80			2.652,50	2.743,59
525,0	549,0			-			2.693,70	2.789,14
550,0	599,0	OF3160550W1E	1.777,82	2.294,52			2.739,25	2.836,84
575,0	599,0			-			2.780,45	2.884,54
600,0	649,0	OF3160600W1E	1.833,30	2.365,30			2.843,36	2.956,12
650,0	699,0	OF3160650W1E	1.890,72	2.438,03			2.897,57	3.016,87
700,0	749,0	OF3160700W1E	1.940,48	2.501,18			2.949,61	3.075,42
750,0	799,0	OF3160750W1E	4.576,24	4.994,86			3.003,86	3.140,49
800,0	849,0	OF3160800W1E	4.660,84	5.085,94			3.060,23	3.203,36
850,0	899,0	OF3160850W1E	4.738,91	5.172,68			Consultar	Consultar
900,0	949,0	OF3160900W1E	4.819,18	5.265,95				
950,0	999,0	OF3160950W1E	4.897,26	5.352,71				
1.000,0	1.049,0	OF3161000W1E	4.979,65	5.443,81				
1.050,0	1.099,0	OF3161050W1E	5.062,08	5.537,05				
1.100,0	1.149,0	OF3161100W1E	5.406,92	5.890,57				
1.150,0	1.199,0	OF3161150W1E	5.489,34	5.981,65				
1.200,0	1.249,0	OF3161200W1E	5.565,24	6.070,59				
1.250,0	1.299,0	OF3161250W1E	5.647,67	6.163,84				
1.300,0	1.349,0	OF3161300W1E	5.730,09	6.254,93				
1.350,0	1.399,0	OF3161350W1E	5.805,99	6.339,52				
1.400,0	1.449,0	OF3161400W1E	5.888,41	6.432,79				
1.450,0	1.499,0	OF3161450W1E	5.970,83	6.526,05				
1.500,0	1.549,0	OF3161500W1E	6.048,90	6.612,79				
1.550,0	1.599,0	OF3161550W1E	Consultar	Consultar				

Acoplamiento abierto para tubos de cualquier material sin anclaje axial.

Abierto con bisagra.

Código W1 en NBR termina W1N

Código W2 en EPDM termina W2E
Código W2 en NBR termina W2N

Código W5 en EPDM termina W5E
Código W5 en NBR termina W5N

En caso de pedido indicar el diámetro exterior exacto

Junta: EPDM: -20°C hasta +100°C NBR: -20°C hasta +80°C

Fluido: EPDM: Todas las calidades de agua, aguas residuales, aire, sólidos y diversos productos químicos

NBR: Agua, gas, aceite, combustible y otros hidrocarburos
Especificar 1 o 2 cierres

OPEN FLEX 3 PN 20

J1

desde Ø exterior	hasta Ø exterior	W1 CARCASA GALVANIZADA. CIERRES GALVANIZADOS				W5 CARCASA EN ACERO INOX. CIERRES EN ACERO INOX.			
		Ref. EPDM	€ EPDM	Ref. NBR	€ NBR	Ref. EPDM	€ EPDM	Ref. NBR	€ NBR
323,9	349,0	OF3200323W1E	1.502,25	OF3200323W1N	1936,65	OF3200323W5E	2.346,69	OF3200323W5N	2.409,57
350,0	399,0	OF3200350W1E	1.557,74	OF3200350W1N	2009,37	OF3200350W5E	2.390,05	OF3200350W5N	2.457,30
375,0	399,0					OF3200375W5E	2.437,79	OF3200375W5N	2.509,36
400,0	449,0	OF3200400W1E	1.613,23	OF3200400W1N	2080,16	OF3200400W5E	2.478,99	OF3200400W5N	2.554,90
425,0	449,0					OF3200425W5E	2.522,36	OF3200425W5N	2.602,61
450,0	499,0	OF3200450W1E	1.666,82	OF3200450W1N	2150,98	OF3200450W5E	2.565,73	OF3200450W5N	2.650,32
475,0	499,0					OF3200475W5E	2.609,12	OF3200475W5N	2.695,85
500,0	549,0	OF3200500W1E	1.722,31	OF3200500W1N	2221,80	OF3200500W5E	2.652,50	OF3200500W5N	2.743,59
525,0	549,0					OF3200525W5E	2.693,69	OF3200525W5N	2.789,14
550,0	599,0	OF3200550W1E	4.300,82	OF3200550W1N	4682,53	OF3200550W5E	2.739,25	OF3200550W5N	2.836,85
575,0	599,0					OF3200575W5E	2.780,45	OF3200575W5N	2.884,54
600,0	649,0	OF3200600W1E	4.342,02	OF3200600W1N	4732,40	OF3200600W5E	2.843,36	OF3200600W5N	2.956,12
650,0	699,0	OF3200650W1E	4.417,93	OF3200650W1N	4819,18	OF3200650W5E	Consultar	OF3200650W5N	Consultar
700,0	749,0	OF3200700W1E	4.500,36	OF3200700W1N	4910,27				
750,0	799,0	OF3200750W1E	4.576,24	OF3200750W1N	4994,86				
800,0	849,0	OF3200800W1E	4.660,84	OF3200800W1N	5085,95				
850,0	899,0	OF3200850W1E	4.738,91	OF3200850W1N	5172,68				
900,0	949,0	OF3200900W1E	4.819,18	OF3200900W1N	5265,95				
950,0	999,0	OF3200950W1E	4.897,26	OF3200950W1N	5352,71				
1.000,0	1.049,0	OF3201000W1E	4.979,65	OF3201000W1N	5443,82				
1.050,0	1.099,0	OF3201050W1E	5.062,08	OF3201050W1N	5537,05				
1.100,0	1.149,0	OF3201100W1E	5.406,92	OF3201100W1N	5890,57				
1.150,0	1.199,0	OF3201150W1E	Consultar	OF3201150W1N	Consultar				

Acoplamiento abierto para tubos de cualquier material sin anclaje axial.
 Abierto con bisagra.

En caso de pedido indicar el diámetro exterior exacto

Junta: EPDM: -20°C hasta +100°C NBR: -20°C hasta +80°C

Fluido: EPDM: Todas las calidades de agua, aguas residuales, aire, sólidos y diversos productos químicos

NBR: Agua, gas, aceite, combustible y otros hidrocarburos
 Especificar 1 o 2 cierres

OPEN FLEX 3 PN 25

J1

desde Ø exterior	hasta Ø exterior	W1 CARCASA GALVANIZADA. CIERRES GALVANIZADOS				W5 CARCASA EN ACERO INOX. CIERRES EN ACERO INOX.			
		Ref. EPDM	€ EPDM	Ref. NBR	€ NBR	Ref. EPDM	€ EPDM	Ref. NBR	€ NBR
323,9	349,0	OF3250323W1E	1.502,25	OF3250323W1N	1936,65	OF3250323W5E	2.346,69	OF3250323W5N	2.409,57
350,0	399,0	OF3250350W1E	1.557,74	OF3250350W1N	2009,37	OF3250350W5E	2.390,05	OF3250350W5N	2.457,30
375,0	399,0					OF3250375W5E	2.437,79	OF3250375W5N	2.509,36
400,0	449,0	OF3250400W1E	1.613,23	OF3250400W1N	2080,16	OF3250400W5E	2.478,99	OF3250400W5N	2.554,90
425,0	449,0					OF3250425W5E	2.522,36	OF3250425W5N	2.602,61
450,0	499,0	OF3250450W1E	1.666,82	OF3250450W1N	2150,98	OF3250450W5E	2.565,73	OF3250450W5N	2.650,32
475,0	499,0					OF3250475W5E	2.609,12	OF3250475W5N	2.695,85
500,0	549,0					OF3250500W5E	Consultar	OF3250500W5N	Consultar
550,0	599,0	OF3250550W1E	4.300,82	OF3250550W1N	4682,53				
600,0	649,0	OF3250600W1E	4.342,02	OF3250600W1N	4732,40				
650,0	699,0	OF3250650W1E	4.417,93	OF3250650W1N	4819,18				
700,0	749,0	OF3250700W1E	4.500,36	OF3250700W1N	4910,27				
750,0	799,0	OF3250750W1E	4.576,24	OF3250750W1N	4994,86				
800,0	849,0	OF3250800W1E	4.660,84	OF3250800W1N	5085,95				
850,0	899,0	OF3250850W1E	4.738,91	OF3250850W1N	5172,68				
900,0	949,0	OF3250900W1E	4.819,18	OF3250900W1N	5265,95				
950,0	999,0	OF3250950W1E	Consultar	OF3250950W1N	Consultar				

Acoplamiento abierto para tubos de cualquier material sin anclaje axial.
 Abierto con bisagra.

En caso de pedido indicar el diámetro exterior exacto

Junta: EPDM: -20°C hasta +100°C NBR: -20°C hasta +80°C

Fluido: EPDM: Todas las calidades de agua, aguas residuales, aire, sólidos y diversos productos químicos

NBR: Agua, gas, aceite, combustible y otros hidrocarburos
 Especificar 1 o 2 cierres



STEP FLEX 2

J1

CARCASA GALVANIZADA / ACERO INOXIDABLE

Ø exterior tubo 1	Ø exterior tubo 2	Ref. EPDM	€ EPDM
219,1	230 - 250	STF2219E	Consultar
250,0	220 - 280	STF2250E	Consultar
267,0	237 - 297	STF2267E	Consultar
273,0	243 - 303	STF2273E	Consultar
304,0	274 - 334	STF2304E	Consultar
323,9	293 - 353	STF2323E	Consultar
355,6	325 - 385	STF2355E	Consultar
406,4	376 - 436	STF2406E	Consultar
457,2	427 - 487	STF2457E	Consultar
508,0	478 - 538	STF2508E	Consultar
558,8	528 - 588	STF2558E	Consultar
609,6	579 - 639	STF2609E	Consultar
711,2	681 - 741	STF2711E	Consultar
762,0	732 - 792	STF2762E	Consultar
812,8	782 - 842	STF2812E	Consultar

Acoplamiento para tubos de cualquier material sin anclaje axial.
 Unión para tuberías de diferentes materiales y diámetros.

Junta: EPDM: -20°C hasta +100°C
Fluido: EPDM: Todas las calidades de agua, aguas residuales, aire, sólidos y diversos productos químicos



STEP FLEX 3

J1

CARCASA GALVANIZADA / ACERO INOXIDABLE

Ø exterior tubo 1	Ø exterior tubo 2	Ref. EPDM	€ EPDM
914,4	884 - 944	STF30914E	Consultar
1.016,0	986 - 1046	STF31016E	Consultar
1.117,6	1087 - 1147	STF31117E	Consultar
1.219,2	1.189 - 1.249	STF31219E	Consultar
1.320,8	1.290 - 1.350	STF31320E	Consultar
1.422,4	1.392 - 1.452	STF31422E	Consultar
1.524,0	1.494 - 1.554	STF31524E	Consultar
1.600,0	1.570 - 1.630	STF31600E	Consultar
1.625,4	1.595 - 1.655	STF31625E	Consultar
1.727,2	1.697 - 1.757	STF31727E	Consultar
1.828,8	1.798 - 1.858	STF31828E	Consultar
1.930,4	1.900 - 1.960	STF31930E	Consultar
2.032,0	2.002 - 2.062	STF32032E	Consultar

Acoplamiento para tubos de cualquier material sin anclaje axial.
 Unión para tuberías de diferentes materiales y diámetros.

Junta: EPDM: -20°C hasta +100°C
Fluido: EPDM: Todas las calidades de agua, aguas residuales, aire, sólidos y diversos productos químicos

Recambios

INDUSTRIA





Recambios





INDUSTRIA

Recambios Válvulas manuales

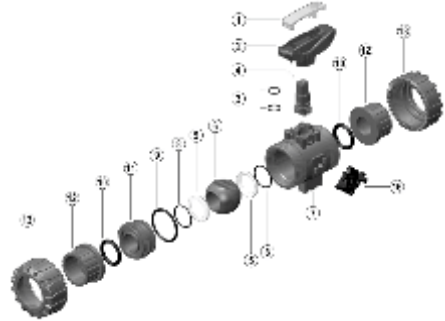

VKD / VKR

Válvula de bola VK DUAL BLOCK® DN10÷50.

d	DN	Ref. EPDM	€	Ref. FKM	€
16-20	10-15	SETVKD020E	15,96	SETVKD020F	35,13
25	20	SETVKD025E	19,53	SETVKD025F	36,29
32	25	SETVKD032E	26,47	SETVKD032F	41,25
40	32	SETVKD040E	35,99	SETVKD040F	54,14
50	40	SETVKD050E	42,92	SETVKD050F	64,82
63	50	SETVKD063E	57,53	SETVKD063F	110,13

Juego de juntas y asientos VKD / VKR.
Posiciones 3-5-8-9-10.

d	DN	Ref.	€
16-20	10-15	HSVKD020	11,66
25	20	HSVKD025	12,91
32	25	HSVKD032	13,69
40	32	HSVKD040	14,60
50	40	HSVKD050	16,69
63	50	HSVKD063	21,34

Maneta VKD / VKR.
Posiciones 1-2.

Set maneta VKD / VKR
compuesto por maneta y herramienta de apriete

d	DN	Ref.	€
16-20	10-15	DBVKD020025	16,42
25	20	DBVKD020025	16,42
32	25	DBVKD032	16,42
40	32	DBVKD040050	16,42
50	40	DBVKD040050	16,42
63	50	DBVKD063	16,42

VKD / VKR DUAL BLOCK® kit.
Posición 16.

d	DN	Ref. PVC-U	€	Ref. PP-H	€	Ref. PVDF	€	Ref. C-PVC	€
16-20	10-15	STVKD020V	12,77	STVKD020M	18,22	STVKD020F	37,59	STVKD020C	25,08
25	20	STVKD025V	18,53	STVKD025M	26,22	STVKD025F	45,59	STVKD025C	36,49
32	25	STVKD032V	22,08	STVKD032M	30,77	STVKD032F	56,98	STVKD032C	43,32
40	32	STVKD040V	26,30	STVKD040M	36,49	STVKD040F	79,78	STVKD040C	52,41
50	40	STVKD050V	32,31	STVKD050M	44,44	STVKD050F	85,48	STVKD050C	63,83
63	50	STVKD063V	37,20	STVKD063M	51,28	STVKD063F	136,76	STVKD063C	72,93

Eje VKD / VKR.
Posición 4.

Continúa en la página siguiente...

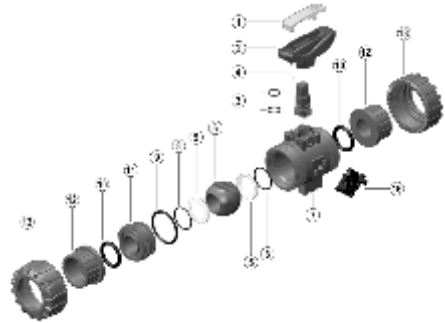

d	DN	Ref. PVC-U	€	Ref. PP-H	€	Ref. PVDF	€	Ref. C-PVC	€
16-20	10-15	BLVKD020V	12,95	BLVKD020M	18,22	BLVKD020F	33,69	BLVKD020C	25,08
25	20	BLVKD025V	18,53	BLVKD025M	26,02	BLVKD025F	37,59	BLVKD025C	36,49
32	25	BLVKD032V	25,17	BLVKD032M	35,13	BLVKD032F	55,93	BLVKD032C	50,16
40	32	BLVKD040V	30,23	BLVKD040M	42,16	BLVKD040F	67,26	BLVKD040C	59,26
50	40	BLVKD050V	48,59	BLVKD050M	67,06	BLVKD050F	105,68	BLVKD050C	95,72
63	50	BLVKD063V	66,51	BLVKD063M	93,14	BLVKD063F	144,50	BLVKD063C	132,19

Bola VKD.
 Posición 6.

d	DN	Ref. PVC-U	€	Ref. PP-H	€	Ref. PVDF	€	Ref. C-PVC	€
16-20	10-15	SEVKD020V	14,01	SEVKD020M	14,97	SEVKD020F	29,58	SEVKD020C	17,28
25	20	SEVKD025V	15,54	SEVKD025M	18,68	SEVKD025F	35,77	SEVKD025C	18,35
32	25	SEVKD032V	15,54	SEVKD032M	18,68	SEVKD032F	42,97	SEVKD032C	19,80
40	32	SEVKD040V	21,75	SEVKD040M	24,31	SEVKD040F	72,22	SEVKD040C	35,77
50	40	SEVKD050V	21,75	SEVKD050M	27,55	SEVKD050F	72,22	SEVKD050C	35,77
63	50	SEVKD063V	27,97	SEVKD063M	31,30	SEVKD063F	86,81	SEVKD063C	39,71

Casquillo VKD / VKR.
 Posición 11.

d	DN	Ref. PVC-U	€	Ref. PP-H	€	Ref. PVDF	€	Ref. C-PVC	€
16-20	10-15	NTVKD020V	7,15	NTVKD020M	9,53	NTVKD020F	39,90	NTVKD020C	13,69
25	20	NTVKD025V	13,54	NTVKD025M	18,22	NTVKD025F	42,16	NTVKD025C	25,08
32	25	NTVKD032V	16,37	NTVKD032M	21,95	NTVKD032F	54,70	NTVKD032C	30,77
40	32	NTVKD040V	17,59	NTVKD040M	23,94	NTVKD040F	74,07	NTVKD040C	34,19
50	40	NTVKD050V	20,80	NTVKD050M	28,19	NTVKD050F	86,59	NTVKD050C	39,90
63	50	NTVKD063V	31,50	NTVKD063M	43,10	NTVKD063F	134,70	NTVKD063C	61,52

Tuerca VKD / VKR.
 Posición 13.

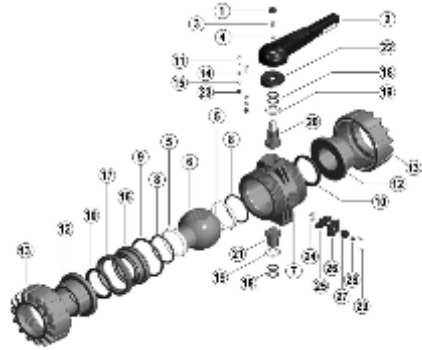

VKD

Válvula de bola VK DUAL BLOCK® DN65÷100.

I.

d	DN	Ref. EPDM	€	Ref. FKM	€
75	65	SETVKD075E	110,28	SETVKD075F	206,31
90	80	SETVKD090E	139,97	SETVKD090F	271,83
110	100	SETVKD110E *	208,67	SETVKD110F	343,26

Juego de juntas y asientos VKD.

Posiciones 5-8-9-10-18-19.

* No recomendable para la válvula VKD d 110 DN100 en PVDF

d	DN	Ref.	€
75	65	HSFKD0S14	42,17
90	80	HSFKD0M14	53,94
110	100	HSFKD0L17	59,62

Maneta VKD.

Posiciones 1-2-3-4.

Set maneta VKD compuesto por maneta y herramienta de apriete

d	DN	Ref. PVC-U	€	Ref. PP-H	€	Ref. PVDF	€	Ref. C-PVC	€
75	65	STVKD075V	69,95	STVKD075M	90,15	STVKD075F	171,46	STVKD075C	81,75
90	80	STVKD090V	93,23	STVKD090M	108,79	STVKD090F	195,39	STVKD090C	88,40
110	100	STVKD110V	105,68	STVKD110M	116,56	STVKD110F	220,68	STVKD110C	108,79

Eje superior VKD.

Posición 20.

d	DN	Ref. PVC-U	€	Ref. PP-H	€	Ref. PVDF	€	Ref. C-PVC	€
75	65	LSVKD075V	38,86	LSVKD075M	54,39	LSVKD075F	77,71	LSVKD075C	54,39
90	80	LSVKD090V	46,63	LSVKD090M	62,16	LSVKD090F	101,02	LSVKD090C	62,16
110	100	LSVKD110V	54,39	LSVKD110M	85,48	LSVKD110F	116,56	LSVKD110C	85,48

Eje inferior VKD.

Posición 21.

Continúa en la página siguiente...

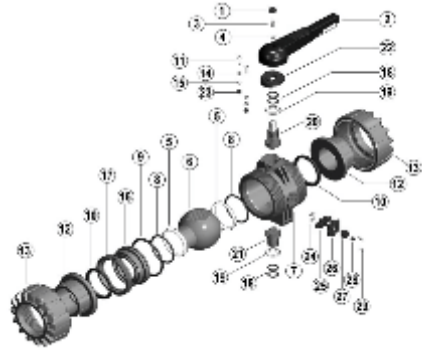

d	DN	Ref. PVC-U	€	Ref. PP-H	€	Ref. PVDF	€	Ref. C-PVC	€
75	65	BLVKD075V	135,62	BLVKD075M	189,16	BLVKD075F	328,21	BLVKD075C	150,93
90	80	BLVKD090V	211,77	BLVKD090M	295,19	BLVKD090F	547,00	BLVKD090C	243,78
110	100	BLVKD110V	282,82	BLVKD110M	356,91	BLVKD110F	691,55	BLVKD110C	325,61

Bola VKD.
 Posición 6.

d	DN	Ref. PVC-U	€	Ref. PP-H	€	Ref. PVDF	€	Ref. C-PVC	€
75	65	SEVKD075V	42,14	SEVKD075M	72,12	SEVKD075F	221,26	SEVKD075C	76,93
90	80	SEVKD090V	58,76	SEVKD090M	88,01	SEVKD090F	302,07	SEVKD090C	100,28
110	100	SEVKD110V	80,84	SEVKD110M	108,79	SEVKD110F	357,44	SEVKD110C	135,98

Casquillo VKD.
 Posiciones 16-17.

d	DN	Ref. PVC-U	€	Ref. PP-H	€	Ref. PVDF	€	Ref. C-PVC	€
75	65	NTVKD075V	56,45	NTVKD075M	71,81	NTVKD075F	271,97	NTVKD075C	71,81
90	80	NTVKD090V	72,27	NTVKD090M	81,53	NTVKD090F	537,70	NTVKD090C	132,09
110	100	NTVKD110V	109,58	NTVKD110M	112,68	NTVKD110F	626,29	NTVKD110C	206,69

Tuerca VKD.
 Posición 13.

d	DN	Ref.	€
75-110	65-100	DBVKD075110	23,92

VKD DUAL BLOCK® kit.
 Posiciones 24-25-26-27-28-29.

d	DN	Ref.	€
75-110	65-100	UFFK160	21,16

Brida superior con trinquete VKD.
 Posiciones 11-14-15-22-23.

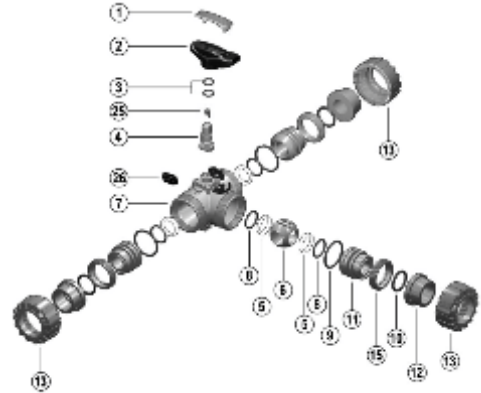

TKD

Válvula de bola 3 vías VK DUAL BLOCK®.

d	DN	Ref. EPDM	€	Ref. FKM	€
16-20	10-15	SETTKD020E	10,47	SETTKD020F	34,51
25	20	SETTKD025E	18,26	SETTKD025F	48,08
32	25	SETTKD032E	19,73	SETTKD032F	59,50
40	32	SETTKD040E	35,56	SETTKD040F	86,92
50	40	SETTKD050E	44,12	SETTKD050F	140,19
63	50	SETTKD063E	58,60	SETTKD063F	177,39

Juego de juntas y asientos TKD.

Posiciones 3-5-8-9-10.

d	DN	Ref.	€	d	DN	Ref.	€	d	DN	Ref.	€
16-20	10-15	HSTKD020	11,66	16-20	10-15	DBTKD020025	16,42	16-20	10-15	PITKD020	1,49
25	20	HSTKD025	12,91	25	20	DBTKD020025	16,42	25	20	PITKD025032	1,49
32	25	HSTKD032	13,69	32	25	DBTKD032040	16,42	32	25	PITKD025032	1,49
40	32	HSTKD040	14,60	40	32	DBTKD032040	16,42	40	32	PITKD040050	1,49
50	40	HSTKD050	16,69	50	40	DBTKD050063	16,42	50	40	PITKD040050	1,49
63	50	HSTKD063	21,34	63	50	DBTKD050063	16,42	63	50	PITKD063	1,49

Maneta TKD.

Posiciones 1-2.

Maneta y herramienta
de apriete

TKD DUAL BLOCK® kit.

Posición 26.

TKD indicador óptico.

Posición 25.

d	DN	Ref. PVC-U	€	Ref. PP-H	€	Ref. C-PVC	€
16-20	10-15	STVKD020V	12,77	STVKD020M	18,22	STVKD020C	25,08
25	20	STVKD025V	18,53	STVKD025M	26,22	STVKD025C	36,49
32	25	STVKD032V	22,08	STVKD032M	30,77	STVKD032C	43,32
40	32	STVKD040V	26,30	STVKD040M	36,49	STVKD040C	52,41
50	40	STVKD050V	32,31	STVKD050M	44,44	STVKD050C	63,83
63	50	STVKD063V	37,20	STVKD063M	51,28	STVKD063C	72,93

Eje TKD.

Posición 4.

Continúa en la página siguiente...

d	DN	Ref. PVC-U	€	Ref. PP-H	€	Ref. C-PVC	€
16-20	10-15	BLTKD020V	20,20	BLTKD020M	30,29	BLTKD020C	30,29
25	15	BLTKD025V	22,55	BLTKD025M	33,42	BLTKD025C	33,42
32	20	BLTKD032V	31,07	BLTKD032M	44,30	BLTKD032C	44,30
40	25	BLTKD040V	34,19	BLTKD040M	59,84	BLTKD040C	59,84
50	32	BLTKD050V	53,62	BLTKD050M	75,38	BLTKD050C	75,38
63	40	BLTKD063V	73,84	BLTKD063M	102,58	BLTKD063C	102,58

Bola "T" TKD.

Posición 6.

d	DN	Ref. PVC-U	€	Ref. PP-H	€	Ref. C-PVC	€
16-20	10-15	BLLKD020V	20,20	BLLKD020M	30,29	BLLKD020C	30,29
25	20	BLLKD025V	22,55	BLLKD025M	33,42	BLLKD025C	33,42
32	25	BLLKD032V	31,07	BLLKD032M	44,30	BLLKD032C	44,30
40	32	BLLKD040V	34,19	BLLKD040M	62,16	BLLKD040C	59,84
50	40	BLLKD050V	53,62	BLLKD050M	75,38	BLLKD050C	75,38
63	50	BLLKD063V	73,84	BLLKD063M	102,58	BLLKD063C	102,57

Bola "L" TKD.

Posición 6.

d	DN	Ref. PVC-U	€	Ref. PP-H	€	Ref. C-PVC	€
16-20	10-15	SETKD020V	21,75	SETKD020M	27,97	SETKD020C	27,97
25	20	SETKD025V	24,87	SETKD025M	27,97	SETKD025C	31,07
32	25	SETKD032V	24,87	SETKD032M	31,07	SETKD032C	31,07
40	32	SETKD040V	27,97	SETKD040M	41,95	SETKD040C	41,95
50	40	SETKD050V	34,19	SETKD050M	49,73	SETKD050C	49,73
63	50	SETKD063V	41,95	SETKD063M	62,16	SETKD063C	62,16

Casquillo TKD.

Posiciones 11-15.

d	DN	Ref. PVC-U	€	Ref. PP-H	€	Ref. C-PVC	€
16-20	10-15	NTVKD020V	7,15	NTVKD020M	9,53	NTVKD020C	13,69
25	20	NTVKD025V	13,54	NTVKD025M	18,22	NTVKD025C	25,08
32	25	NTVKD032V	16,37	NTVKD032M	21,95	NTVKD032C	30,77
40	32	NTVKD040V	17,59	NTVKD040M	23,94	NTVKD040C	34,19
50	40	NTVKD050V	20,80	NTVKD050M	28,19	NTVKD050C	39,90
63	50	NTVKD063V	31,50	NTVKD063M	43,10	NTVKD063C	61,52

Tuerca TKD.

Posición 13.

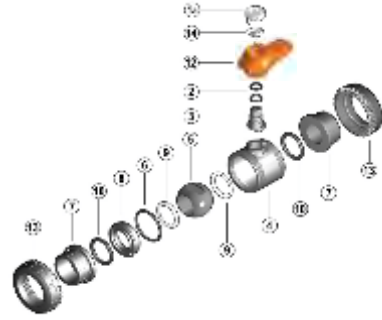

VXE

Válvula de bola VX Easyfit DN15÷50.

d	DN	Ref. EPDM	€	Ref. FKM	€	d	DN	Ref.	€
16-20	10-15	SETVX020E	7,82	SETVX020F	23,12	16-20	10-15	HSVXE020	7,43
25	20	SETVX025E	10,31	SETVX025F	31,31	25	20	HSVXE025	8,80
32	25	SETVX032E	14,62	SETVX032F	38,85	32	25	HSVXE032	11,09
40	32	SETVX040E	22,03	SETVX040F	60,38	40	32	HSVXE040	17,29
50	40	SETVX050E	25,54	SETVX050F	81,94	50	40	HSVXE050	17,70
63	50	SETVX063E	38,92	SETVX063F	140,35	63	50	HSVXE063	26,74

Juego de juntas y asientos VXE. Posiciones 2-6-9-10.

Set maneta VXE. Posiciones 1a-12-14. Maneta y tapón

d	DN	Ref. PVC-U	€	Ref. C-PVC	€
16-20	10-15	BLVX020V	12,95	BLVX020C	25,08
25	20	BLVX025V	18,53	BLVX025C	36,49
32	25	BLVX032V	25,17	BLVX032C	50,16
40	32	BLVX040V	30,23	BLVX040C	59,26
50	40	BLVX050V	48,59	BLVX050C	95,72
63	50	BLVX063V	66,51	BLVX063C	132,19

Bola VXE. Posición 5.

d	DN	Ref. PVC-U	€	Ref. C-PVC	€
16-20	10-15	STVXE020V	12,77	STVXE020C	25,08
25	20	STVXE025V	18,53	STVXE025C	36,49
32	25	STVXE032V	22,08	STVXE032C	43,32
40	32	STVXE040V	26,30	STVXE040C	52,41
50	40	STVXE050V	32,31	STVXE050C	63,83
63	50	STVXE063V	37,20	STVXE063C	72,93

Eje VXE. Posición 3.

d	DN	Ref. PVC-U	€	Ref. C-PVC	€
16-20	10-15	SEVX020V	3,74	SEVX020C	6,17
25	20	SEVX025V	4,99	SEVX025C	8,58
32	25	SEVX032V	4,05	SEVX032C	7,01
40	32	SEVX040V	6,96	SEVX040C	12,01
50	40	SEVX050V	6,12	SEVX050C	11,20
63	50	SEVX063V	14,42	SEVX063C	25,00

Casquillo VXE. Posición 8.

d	DN	Ref. PVC-U	€	Ref. C-PVC	€
16-20	10-15	NTVXE020V	6,83	NTVXE020C	11,34
25	20	NTVXE025V	7,68	NTVXE025C	21,75
32	25	NTVXE032V	9,22	NTVXE032C	25,68
40	32	NTVXE040V	12,12	NTVXE040C	27,97
50	40	NTVXE050V	14,96	NTVXE050C	33,42
63	50	NTVXE063V	19,49	NTVXE063C	50,50

Tuerca VXE. Posición 13.

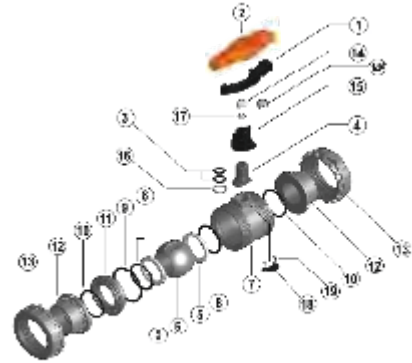

VXE

Válvula de bola VX Easyfit DN65÷100.

d	DN	Ref. EPDM	€	Ref. FKM	€
75	65	SETVXE075E	44,40	SETVXE075F	150,29
90	80	SETVXE090E	55,48	SETVXE090F	192,33
110	100	SETVXE110E	66,40	SETVXE110F	232,42

Juego de juntas y asientos VXE.

Posiciones 3-5-8-9-10-16.

d	DN	Ref. PVC-U	€
75	65	BLVXE075V	135,63
90	80	BLVXE090V	211,77
110	100	BLVXE110V	282,82

Bola VXE.

Posición 6.

d	DN	Ref. PVC-U	€
75	65	STVXE090V	76,78
90	80	STVXE090V	76,78
110	100	STVXE110V	88,91

Eje VXE.

Posición 4.

d	DN	Ref. PVC-U	€
75	65	SEVXE075V	54,39
90	80	SEVXE090V	70,24
110	100	SEVXE110V	114,79

Casquillo VXE.

Posición 11.

d	DN	Ref. PVC-U	€
75	65	NTVXE075V	56,45
90	80	NTVXE090V	72,27
110	100	NTVXE110V	109,58

Tuerca VXE.

Posición 13.

d	DN	Ref.	€
75-90	65-80	HUBVXE090	13,49
110	100	HUBVXE110	15,67

Dado porta etiquetas.

Posición 14-15-17.

d	DN	Ref.	€
75	65	HSVXE075	39,96
90	80	HSVXE090	40,39
110	100	HSVXE110	51,61

Set maneta VXE.

Posiciones 1-2.

Maneta y tapón

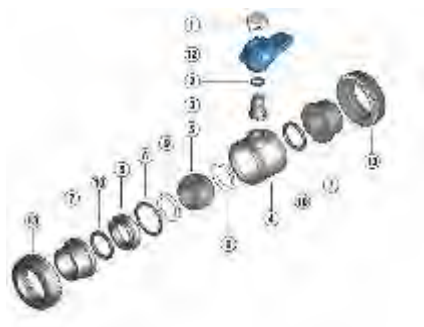

VEE

Válvula de bola VE Easyfit DN15÷50.

d	DN	Ref. EPDM	€
16-20	10-15	SETVE020E	3,34
25	20	SETVE025E	4,07
32	25	SETVE032E	5,72
40	32	SETVE040E	8,26
50	40	SETVE050E	12,37
63	50	SETVE063E	14,97

Juego de juntas y asientos VEE.

Posiciones 2-6-9-10.

d	DN	Ref. PVC-U	€
16-20	10-15	STVXE020V	12,77
25	20	STVXE025V	18,53
32	25	STVXE032V	22,08
40	32	STVXE040V	26,30
50	40	STVXE050V	32,31
63	50	STVXE063V	37,20

Eje VEE.

Posición 3.

d	DN	Ref. PVC-U	€
16-20	10-15	SEVX020V	3,74
25	20	SEVX025V	4,99
32	25	SEVX032V	4,05
40	32	SEVX040V	6,96
50	40	SEVX050V	6,12
63	50	SEVX063V	14,42

Casquillo VEE.

Posición 8.

d	DN	Ref.	€
16-20	10-15	HSVVEE020	7,43
25	20	HSVVEE025	8,80
32	25	HSVVEE032	11,09
40	32	HSVVEE040	14,62
50	40	HSVVEE050	17,70
63	50	HSVVEE063	23,51

Maneta VEE.

Posiciones 1-12.

Set maneta VEE
 compuesto por maneta y tapón

d	DN	Ref. PVC-U	€
16-20	10-15	BLVX020V	12,95
25	20	BLVX025V	18,53
32	25	BLVX032V	25,17
40	32	BLVX040V	30,23
50	40	BLVX050V	48,59
63	50	BLVX063V	66,51

Bola VEE.

Posición 5.

d	DN	Ref. PVC-U	€
16-20	10-15	NTVXE020V	6,83
25	20	NTVXE025V	7,68
32	25	NTVXE032V	9,22
40	32	NTVXE040V	12,12
50	40	NTVXE050V	14,96
63	50	NTVXE063V	19,49

Tuerca VEE.

Posición 13.

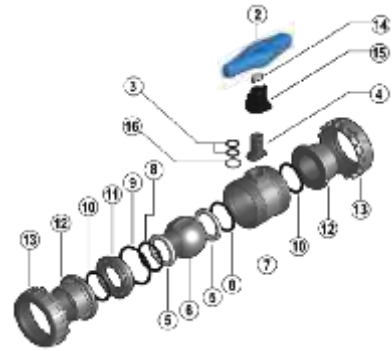

VEE

Válvula de bola VE Easyfit DN65÷100.

d	DN	Ref. EPDM	€
75	65	SETVEE075E	15,91
90	80	SETVEE090E	19,69
110	100	SETVEE110E	25,01

Juego de juntas y asientos VEE.

Posiciones 3-5-8-9-10-16.

d	DN	Ref. PVC-U	€
75	65	BLVXE075V	135,63
90	80	BLVXE090V	211,77
110	100	BLVXE110V	282,82

Bola VEE.

Posición 6.

d	DN	Ref. PVC-U	€
75	65	STVXE090V	76,78
90	80	STVXE090V	76,78
110	100	STVXE110V	88,91

Eje VEE.

Posición 4.

d	DN	Ref.	€
75-90	65-80	HUBVEE090	13,22
110	100	HUBVEE110	15,38

Dado porta etiquetas.

Posición 14-15-17.

d	DN	Ref.	€
75	65	HAVEE075	29,78
90	80	HAVEE090	33,36
110	100	HAVEE110	38,03

Maneta VEE.

Posición 2.

d	DN	Ref. PVC-U	€
75	65	NTVXE075V	56,45
90	80	NTVXE090V	72,27
110	100	NTVXE110V	109,58

Tuerca VEE.

Posición 13.

d	DN	Ref. PVC-U	€
75	65	SEVXE075V	54,39
90	80	SEVXE090V	70,24
110	100	SEVXE110V	114,79

Casquillo VEE.

Posición 11.

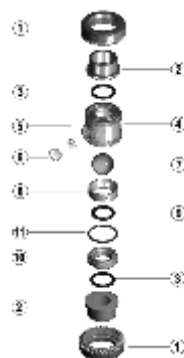

SXE

Válvula anti retorno de bola SX Easyfit DN10÷50.

d	DN	Ref. EPDM	€	Ref. FKM	€
16-20	10-15	SETSXE020E	4,65	SETSXE020F	14,23
25	20	SETSXE025E	6,80	SETSXE025F	20,74
32	25	SETSXE032E	8,12	SETSXE032F	22,92
40	32	SETSXE040E	8,46	SETSXE040F	33,57
50	40	SETSXE050E	10,15	SETSXE050F	33,57
63	50	SETSXE063E	19,26	SETSXE063F	73,27

Juego de juntas y asientos SXE. Posiciones 3-9-11.

d	DN	Ref. PVC-U	€
16-20	10-15	BLSR020V	18,65
25	20	BLSR025V	18,65
32	25	BLSR032V	22,80
40	32	BLSR040V	37,29
50	40	BLSR050V	48,70
63	50	BLSR063V	67,88

Bola SXE. Posición 7.

d	DN	Ref. PVC-U	€
16-20	10-15	SESXE020V	3,74
25	20	SESXE025V	4,99
32	25	SESXE032V	4,05
40	32	SESXE040V	6,96
50	40	SESXE050V	6,12
63	50	SESXE063V	14,42

Casquillo SXE. Posición 10.

d	DN	Ref. PVC-U	€
16-20	10-15	PRSXE020V	4,53
25	20	PRSXE025V	5,58
32	25	PRSXE032V	7,57
40	32	PRSXE040V	8,32
50	40	PRSXE050V	10,17
63	50	PRSXE063V	12,07

Anillo de sujeción SXE. Posición 8.

d	DN	Ref.	€	d	DN	Ref. PVC-U	€
32	25	LCE020	35,37	16-20	10-15	NTVXE020V	6,83
40	32	LCE025	35,53	25	20	NTVXE025V	7,68
50	40	LCE032	37,81	32	25	NTVXE032V	9,22
63	50	LCE032	37,81	40	32	NTVXE040V	12,12
				50	40	NTVXE050V	14,96
				63	50	NTVXE063V	19,49

Set LCE. Set tapón transparente + disco en PVC blanco (10 piezas de cada por set)
 Posiciones 5-6.

Tuerca SXE. Posición 1.



SXE

Válvula anti retorno de bola SX Easyfit DN65±100.

d	DN	Ref. EPDM	€	Ref. FKM	€
75	65	SETSXE075E	36,91	SETSXE075F	116,50
90	80	SETSXE090E	46,30	SETSXE090F	145,30
110	100	SETSXE110E	60,76	SETSXE110F	197,70

Juego de juntas y asientos SXE.

Posiciones 3-9-11.

d	DN	Ref. PVC-U	€
75	65	BLSXE075V	134,84
90	80	BLSXE090V	169,14
110	100	BLSXE110V	221,96

Bola SXE.

Posición 7.

d	DN	Ref. PVC-U	€
75	65	SESXE075V	25,61
90	80	SESXE090V	32,13
110	100	SESXE110V	42,16

Casquillo SXE.

Posición 10.

d	DN	Ref. PVC-U	€
75	65	PRSXE075V	32,29
90	80	PRSXE090V	40,50
110	100	PRSXE110V	53,16

Anillo de sujeción SXE.

Posición 8.

d	DN	Ref.	€
75	65	LCE063	52,08
90	80	LCE063	52,08
110	100	LCE063	52,08

Set LCE. Set tapón transparente + disco en PVC blanco (10 piezas de cada por set)
 Posiciones 5-6.

d	DN	Ref. PVC-U	€	Ref. C-PVC	€
75	65	NTVXE075V	56,45	NTVXE075C	62,16
90	80	NTVXE090V	72,27	NTVXE090C	80,83
110	100	NTVXE110V	109,58	NTVXE110C	114,24

Tuerca SXE.

Posición 1.

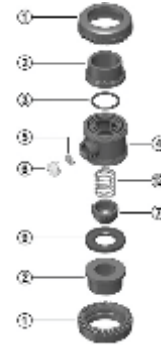

SSE

Válvula anti retorno con muelle SS Easyfit DN10÷50.

d	DN	Ref. EPDM	€	Ref. FKM	€	d	DN	Ref. PVC-U	€	Ref. C-PVC	€
16-20	10-15	SETSSE020E	4,10	SETSSE020F	12,01	16-20	10-15	NTVXE020V	6,83	NTVXE020C	11,34
25	20	SETSSE025E	5,97	SETSSE025F	17,49	25	20	NTVXE025V	7,68	NTVXE025C	21,75
32	25	SETSSE032E	7,14	SETSSE032F	19,33	32	25	NTVXE032V	9,22	NTVXE032C	25,68
40	32	SETSSE040E	7,41	SETSSE040F	28,31	40	32	NTVXE040V	12,12	NTVXE040C	27,97
50	40	SETSSE050E	8,90	SETSSE050F	28,31	50	40	NTVXE050V	14,96	NTVXE050C	33,42
63	50	SETSSE063E	16,87	SETSSE063F	61,74	63	50	NTVXE063V	19,49	NTVXE063C	50,50

Juego de juntas SSE.

Posiciones 3-9.

Tuerca SSE.

Posición 1.

d	DN	Ref. muelle INOX A316	€	Ref. muelle INOX recubierto PTFE	€	Ref. muelle Hastelloy	€
16-20	10-15	ASSE020VX	16,34			ASSE020VH	48,69
25	20	ASSE025VX	16,34			ASSE025VH	45,79
32	25	ASSE032VX	19,96			ASSE032VH	51,87
40	32	ASSE040VX	32,68	ASSE040V0P	46,14		
50	40	ASSE050VX	42,67	ASSE050V0P	57,70		
63	50	ASSE063VX	59,50	ASSE063V0P	79,12		

Tapón + muelle SSE.

Posiciones 7-12.

d	DN	Ref.	€
32	25	LCE020	Ver válvulas manuales
40	32	LCE025	Ver válvulas manuales
50-63	40-50	LCE032	Ver válvulas manuales

Set LCE.

Posiciones 5-6.

Set tapón transparente + disco en PVC blanco (10 piezas de cada por set)

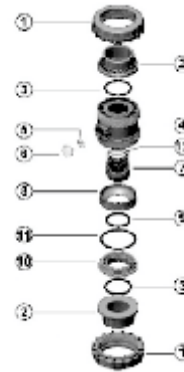

SSE

Válvula anti retorno con muelle SS Easyfit DN65÷100.

d	DN	Ref. EPDM	€	Ref. FKM	€
75	65	SETSXE075E	36,91	SETSXE075F	116,50
90	80	SETSXE090E	46,30	SETSXE090F	145,30
110	100	SETSXE110E	60,76	SETSXE110F	197,70

Juego de juntas SSE.

Posiciones 3-9-11.

d	DN	Ref.	€
75	65	LCE063	Ver válvulas manuales
90	80	LCE063	Ver válvulas manuales
110	100	LCE063	Ver válvulas manuales

Set LCE.

Posiciones 5-6.

Set tapón transparente + disco en PVC blanco (10 piezas de cada por set)

d	DN	Ref. muelle INOX A316	€	Ref. muelle INOX recubierto PTFE	€
75	65	ASSE075VX	118,15	ASSE075V0P	146,53
90	80	ASSE090VX	148,24	ASSE090V0P	182,48
110	100	ASSE110VX	194,51	ASSE110V0P	230,18

Tapón + muelle SSE.

Posiciones 7-12.

d	DN	Ref. PVC-U	€	Ref. C-PVC	€	d	DN	Ref. PVC-U	€	Ref. C-PVC	€
75	65	SESXE075V	25,61	SESXE075C	74,03	75	65	PRSXE075V	32,29	PRSXE075C	96,96
90	80	SESXE090V	32,13	SESXE090C	96,21	90	80	PRSXE090V	40,50	PRSXE090C	125,25
110	100	SESXE110V	42,16	SESXE110C	180,63	110	100	PRSXE110V	53,16	PRSXE110C	235,16

Casquillo SSE.

Posición 10.

Anillo sujeción SSE.

Posición 8.

d	DN	Ref. PVC-U	€	Ref. C-PVC	€
75	65	NTVXE075V	56,45	NTVXE075C	62,16
90	80	NTVXE090V	72,27	NTVXE090C	80,83
110	100	NTVXE110V	109,58	NTVXE110C	114,24

Casquillo SSE.

Posición 10.

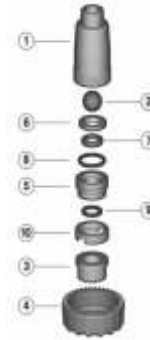

SR

Válvula anti-retorno de bola DN15÷50.

d	DN	Ref. EPDM	€	Ref. FKM	€
20	15	SETSR020E	4,99	SETSR020F	15,17
25	20	SETSR025E	4,99	SETSR025F	15,17
32	25	SETSR032E	5,66	SETSR032F	15,98
40	32	SETSR040E	6,60	SETSR040F	26,18
50	40	SETSR050E	11,40	SETSR050F	37,68
63	50	SETSR063E	14,23	SETSR063F	54,17

Juego de juntas SR. Posiciones 7-8-9.

d	DN	Ref. PPH	€	Ref. PVDF	€
20	15	BLSR020M	26,11	BLSR020F	37,44
25	20	BLSR025M	26,11	BLSR025F	42,93
32	25	BLSR032M	31,88	BLSR032F	102,37
40	32	BLSR040M	52,23	BLSR040F	132,41
50	40	BLSR050M	68,21	BLSR050F	233,81
63	50	BLSR063M	95,00	BLSR063F	356,30

Bola SR. Posición 2.

d	DN	Ref. PPH	€	Ref. PVDF	€
20	15	SESR020M	32,62	SESR020F	76,25
25	20	SESR025M	49,29	SESR025F	106,25
32	25	SESR032M	49,29	SESR032F	115,51
40	32	SESR040M	62,21	SESR040F	189,86
50	40	SESR050M	62,21	SESR050F	189,86
63	50	SESR063M	82,26	SESR063F	273,65

Casquillo SR. Posiciones 5-10

d	DN	Ref. PPH	€	Ref. PVDF	€
20	15	PRSR020M	6,04	PRSR020F	15,10
25	20	PRSR025M	14,34	PRSR025F	18,85
32	25	PRSR032M	14,69	PRSR032F	24,90
40	32	PRSR040M	15,10	PRSR040F	42,99
50	40	PRSR050M	16,62	PRSR050F	53,57
63	50	PRSR063M	20,38	PRSR063F	68,66

Anillo sujeción SR. Posición 6.

d	DN	Ref. PPH	€	Ref. PVDF	€
20	15	NTVKD020M	9,53	NTVKD020F	39,90
25	20	NTVKD025M	18,22	NTVKD025F	42,16
32	25	NTVKD032M	21,95	NTVKD032F	54,70
40	32	NTVKD040M	23,94	NTVKD040F	74,07
50	40	NTVKD050M	28,19	NTVKD050F	86,59
63	50	NTVKD063M	43,10	NTVKD063F	134,70

Tuerca SR. Posición 4.

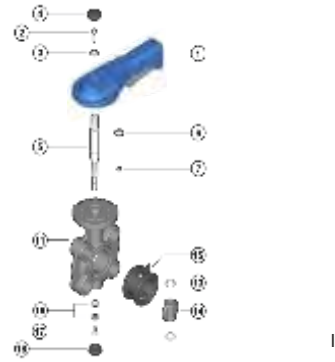

FE

Válvula de mariposa FE DN40÷50.

d	DN	Ref. EPDM	€	Ref. FKM	€
50-63	40-50	SETFK063E	6,16	SETFK063F	14,35

Juego de juntas FE.
 Posiciones 6-7-13.

d	DN	Ref.	€
50-63	40-50	HSFE0S11	31,46

Maneta FE. Con tornillo y tapón de protección
 Posiciones 1-2-3-4.

d	DN	Ref. EPDM	€	Ref. FKM	€
50	40	LIN050E	22,30	LIN050F	133,21
63	50	LIN063E	23,55	LIN063F	140,62

Juego primaria FE.
 Posición 15

d	DN	Ref.	€
50	40	STFE050	54,39
63	50	STFE063	54,39

Eje FE.
 Posición 5.

d	DN	Ref. PVC-U	€
50	40	DISCV050	37,11
63	50	DISCV063	39,28

Disco FE.
 Posición 14.

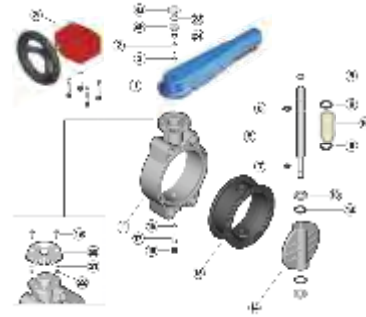

FE

Válvula de mariposa FE DN65÷200.

1

d	DN	Ref. EPDM	€	Ref. FKM	€	d	DN	Ref.	€
75	65	SETFK075E	6,83	SETFK075F	15,96	75	65	STFE075	62,16
90	80	SETFK090E	7,00	SETFK090F	15,96	90	80	STFE090	69,95
110	100	SETFK110E	7,27	SETFK110F	15,96	110	100	STFE110	77,71
140	125	SETFK140E	7,98	SETFK140F	17,03	140	125	STFE140	93,23
160	150	SETFK160E	11,50	SETFK160F	21,32	160	150	STFE160	108,79
225	200	SETFK225E	18,49	SETFK225F	33,05	225	200	STFE225	186,49

Juego de juntas FE.
 Posiciones 6-7-9-12-13.

Eje FE.
 Posición 5.

d	DN	Ref. EPDM	€	Ref. FKM	€	Ref. NBR	€
75	65	LIN075E	24,81	LIN075F	147,99	LIN075N	27,26
90	80	LIN090E	27,32	LIN090F	185,24	LIN090N	30,09
110	100	LIN110E	33,32	LIN110F	267,27	LIN110N	36,63
140	125	LIN140E	45,20	LIN140F	378,99	LIN140N	49,76
160	150	LIN160E	50,12	LIN160F	487,65	LIN160N	55,11
225	200	LIN225E	88,32	LIN225F	853,86	LIN225N	97,19

Junta primaria FE.
 Posición 15.

d	DN	Ref. PVC-U	€	d	DN	Ref.	€	d	DN	Ref.	€
75	65	DISCV075	43,63	75	65	HSFE0S11	31,46	75	65	GEAR01	287,09
90	80	DISCV090	51,33	90	80	HSFE0M14	35,09	90	80	GEAR01	287,09
110	100	DISCV110	66,86	110	100	HSFE0M14	35,09	110	100	GEAR01	287,09
140	125	DISCV140	87,71	140	125	HSFE0L17	38,85	140	125	GEAR02	287,09
160	150	DISCV160	112,24	160	150	HSFE0L17	38,85	160	150	GEAR02	287,09
225	200	DISCV225	155,47	225	200	HSFEXL22	69,06	225	200	GEAR03	351,21

Disco FE.
 Posición 14.

Maneta FE. Con tornillo y tapón de protección
 Posiciones 1-2-3-4.

Kit volante FE Con tornillos y brida si es necesaria
 Posición 29.

d	DN	Ref.	€
225	200	UFFE225	38,31

Brida superior con trinquete FE.
 Posiciones 19-20-21-22.



FK

Válvula de mariposa FK DN40÷50.

d	DN	Ref. EPDM	€	Ref. FKM	€
50-63	40-50	SETFK063E	6,16	SETFK063F	14,25

Juego de juntas FK.
 Posiciones 17-18-23.

d	DN	Ref.	€
50-63	40-50	HSFKD0S11	40,85

Maneta FK. Con tornillo y tapón de protección
 Posiciones 2-3a-3b-4-5.

d	DN	Ref. EPDM	€	Ref. FKM	€
50	40	LIN050E	22,30	LIN050F	133,21
63	50	LIN063E	23,55	LIN063F	140,62

Juego primaria FK
 Posición 26.

d	DN	Ref.	€
50	40	STFK050	63,73
63	50	STFK063	63,73

Eje FK.
 Posición 14.

d	DN	Ref.	€
50	40	ISFK050	34,19
63	50	ISFK063	34,19

Insertos centraje.
 Posición 27.

d	DN	Ref. PVC-U	€	Ref. PP-H	€	Ref. PVDF	€	Ref. C-PVC	€
50	40	DISCV050	37,11	DISCM050	45,28	DISCF050	99,60	DISCC050	54,30
63	50	DISCV063	39,28	DISCM063	47,95	DISCF063	105,45	DISCC063	57,51

Disco FK.
 Posición 25.

d	DN	Ref.	€
50-63	40-50	UFFK160	21,16

Brida superior FK.
 Posiciones 7-10-11-12-28.

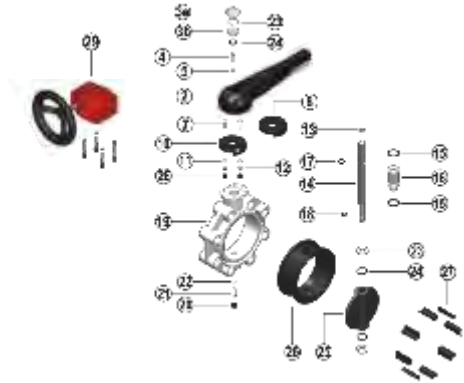

FK

Válvula de mariposa FK DN65÷200.

d	DN	Ref. EPDM	€	Ref. FKM	€
75	65	SETFK075E	6,83	SETFK075F	15,96
90	80	SETFK090E	7,00	SETFK090F	15,96
110	100	SETFK110E	7,27	SETFK110F	15,96
140	125	SETFK140E	7,98	SETFK140F	17,03
160	150	SETFK160E	11,50	SETFK160F	21,32
225	200	SETFK225E	18,49	SETFK225F	33,05

Juego de juntas FK.

Posiciones 15-17-18-23-24.

d	DN	Ref.	€
75	65	STFK075	77,71
90	80	STFK090	93,23
110	100	STFK110	108,79
140	125	STFK140	124,31
160	150	STFK160	155,38
225	200	STFK225	264,18

Eje FK.

Posición 14.

d	DN	Ref.	€
75	65	ISFK075	40,12
90	80	ISFK090	46,16
110	100	ISFK110	50,17
140	125	ISFK140	54,18
160	150	ISFK160	56,19
225	200	ISFK225	60,18

Insertos centraje.

Posición 27.

d	DN	Ref. PVC-U	€	Ref. PP-H	€	Ref. PVDF	€	Ref. C-PVC	€
75	65	DISCV075	43,63	DISCM075	53,30	DISCF075	117,16	DISCC075	63,88
90	80	DISCV090	51,33	DISCM090	61,79	DISCF090	123,44	DISCC090	74,57
110	100	DISCV110	66,86	DISCM110	73,45	DISCF110	132,04	DISCC110	83,06
140	125	DISCV140	87,71	DISCM140	96,48	DISCF140	172,44	DISCC140	100,99
160	150	DISCV160	112,24	DISCM160	112,86	DISCF160	185,24	DISCC160	118,82
225	200	DISCV225	155,47	DISCM225	171,22	DISCF225	234,25	DISCC225	179,11

Disco FK.

Posición 25.

Continúa en la página siguiente...

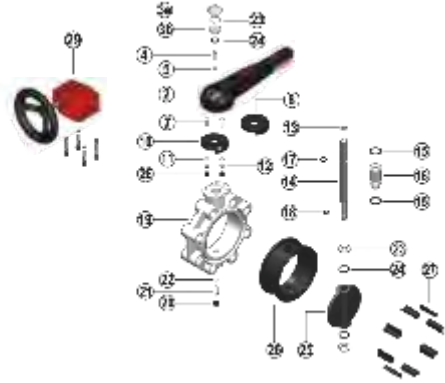

d	DN	Ref.	€
75-110	65-100	GEAR01	287,09
140-160	125-150	GEAR02	287,09
225	200	GEAR03	351,21

Kit volante FK.
 Posición 29.

Con tornillos y brida si es necesaria

d	DN	Ref.	€
75-160	65-150	UFFK160	21,16
225	200	UFFK225	32,16

Brida superior con trinquete FK.
 Posición 7-10-11-12-28.

d	DN	Ref. EPDM	€	Ref. FKM	€	Ref. NBR	€
75	65	LIN075E	24,81	LIN075F	147,99	LIN075N	27,26
90	80	LIN090E	27,32	LIN090F	185,24	LIN090N	30,09
110	100	LIN110E	33,32	LIN110F	267,27	LIN110N	36,63
140	125	LIN140E	45,20	LIN140F	378,99	LIN140N	49,76
160	150	LIN160E	50,12	LIN160F	487,65	LIN160N	55,11
225	200	LIN225E	88,32	LIN225F	853,86	LIN225N	97,19

Junta primaria FK.
 Posición 26.

d	DN	Ref.	€
75	65	HSFKD0S11	40,85
90-110	80-100	HSFKD0M14	53,94
140-160	125-150	HSFKD0L17	59,62
225	200	HSFKDXL22	87,98

Maneta FK.
 Posición 2-3a-3b-4-5.

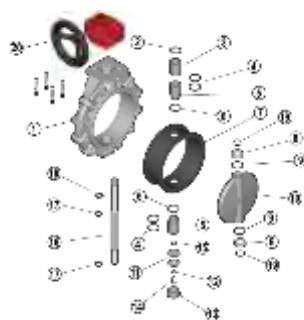

FK

Válvula de mariposa FK DN250÷300.

d	DN	Ref. EPDM	€	Ref. FKM	€
280	250	SETFK315E	58,72	SETFK315F	105,13
315	300	SETFK315E	58,72	SETFK315F	105,13

Juego de juntas FK. *Posición 4-6-9-17-19.*

d	DN	Ref. EPDM	€	Ref. FKM	€
280	250	LIN280E	187,53	LIN280F	1.226,75
315	300	LIN315E	204,16	LIN315F	1.503,67

Junta primaria FK. *Posición 7.*

d	DN	Ref. PVC-U	€	Ref. PP-H	€	Ref. PVDF	€	Ref. C-PVC	€
280	250	DISCV280	300,56	DISCM280	340,02	DISCF280	420,62	DISCC280	361,00
315	300	DISCV315	327,72	DISCM315	371,97	DISCF315	459,16	DISCC315	393,45

Disco FK. *Posición 10.*

d	DN	Ref.	€
280-315	250-300	GEAR04	410,16

d	DN	Ref.	€
280	250	STFK280 (*)	404,04
315	300	STFK315 (*)	466,19

Kit volante FK. *Posición 20.*

Con tornillos y brida si es necesaria



FK

Válvula de mariposa FK DN355÷400.

d	DN	Ref. EPDM	€	Ref. FKM	€
355-400	350-400	SETFK400E	49,74	SETFK400F	94,56

Juego de juntas FK. *Posición 4-6-9-17.*

d	DN	Ref. EPDM	€	Ref. FKM	€
355	350	LIN355E	393,31	LIN355F	2.872,92
400	400	LIN400E	456,92	LIN400F	4.036,89

Junta primaria FK. *Posición 7.*

d	DN	Ref. PVC-U	€	Ref. PP-H	€	Ref. PVDF	€
355	350	DISCV355	578,38	DISCM355	647,78	DISCF355	2.643,20
400	400	DISCV400	647,78	DISCM400	751,90	DISCF400	2.915,05

Disco FK. *Posición 10.*

d	DN	Ref.	€
355-400	350-400	GEAR05	714,13

d	DN	Ref.	€
355	350	STFK355 (*)	561,39
400	400	STFK400 (*)	629,85

Volante FK. *Posición 20.*

Eje FK. *Posición 16.*

(*) Sólo para válvulas con el disco en PVDF-U.
 Para otros materiales consultar

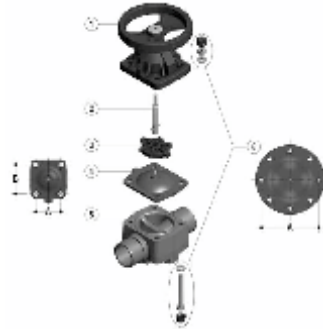

VM

Válvula de membrana VM.

d	DN	Ref. EPDM	€	Ref. FPM	€	Ref. PTFE	€	Ref. NBR	€
90	80	DIA090E	101,97	DIA090F	491,28	DIA090P	443,05	DIA090N	101,97
110	100	DIA110E	206,16	DIA110F	934,34	DIA110P	653,55	DIA110N	206,16

Membrana VM. Posición 4.

d	DN	Ref. PVC-U (EPDM / FKM)	€	Ref. PP-H (EPDM / FKM)	€	Ref. PVDF (EPDM / FKM)	€	Ref. C-PVC (EPDM / FKM)	€
90	80	SPBDVM090DV	186,49	SPBDVM090DM	233,11	SPBDVM090DF	854,76	SPBDVM090DC	365,19
110	100	SPBDVM110DV	248,64	SPBDVM110DM	264,18	SPBDVM110DF	1.243,25	SPBDVM110DC	470,87

d	DN	Ref. PVC-U (PTFE)	€	Ref. PP-H (PTFE)	€	Ref. PVDF (PTFE)	€	Ref. C-PVC (PTFE)	€
90	80	SPBDVMP090DV	206,69	SPBDVMP090DM	256,40	SPBDVMP090DF	878,03	SPBDVMP090DC	385,39
110	100	SPBDVMP110DV	271,97	SPBDVMP110DM	287,51	SPBDVMP110DF	1.266,54	SPBDVMP110DC	491,07

Cuerpo M-M VMD... Posición 5.

d	DN	Ref.	€
90	80	COVMMN075090	101,02
110	100	COVMMN110	108,79

Compresor VM. Posición 3.

d	DN	Ref.	€
90	80	ATVMMN075090	427,37
110	100	ATVMMN110	575,00

Volante DK. Posiciones 1-2-6.

d	DN	Ref.	€
90	80	BSVMMN75090X	88,57
110	100	BSVMMN110X	132,43

Cierres VM. Posiciones 10-11-12.

Kit cierre DK compuesto por tornillos, tuercas y tapones protectores

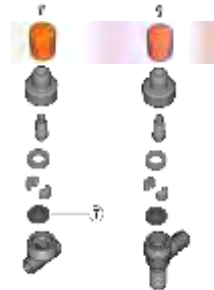

VM-RM

Grifo de membrana VM-RM.

d - Rh	DN	Ref. EPDM	€
12 - 1/4"	8	DIARM020E	8,47
20 - 1/2"	15	DIARM020E	8,47

Cierres VM. Posiciones 10-11-12.

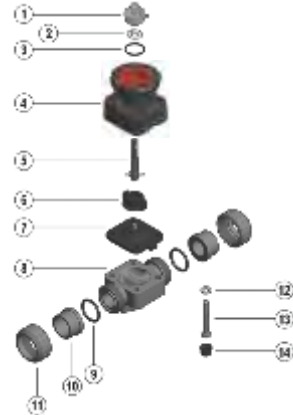

DK

Válvula de membrana DK.

d	DN	Ref. EPDM	€	Ref. FKM	€	Ref. PTFE	€	Ref. NBR	€
20	15	DIA025E	23,07	DIA025F	75,23	DIADK025P	89,41	DIA025N	23,07
25	20	DIA025E	23,07	DIA025F	75,23	DIADK025P	89,41	DIA025N	23,07
32	25	DIA032E	24,09	DIA032F	83,31	DIADK032P	101,97	DIA032N	24,09
40	32	DIA032E	24,09	DIA032F	83,31	DIADK032P	101,97	DIA032N	24,09
50	40	DIA050E	29,59	DIA050F	141,46	DIADK050P	168,90	DIA050N	29,59
63	50	DIA063E	43,88	DIA063F	201,81	DIADK063P	207,20	DIA063N	43,88
75	65	DIA063E	43,88	DIA063F	201,81	DIADK063P	207,20	DIA063N	43,88

Membrana DK.

Posición 7.

d	DN	Ref. PVC-U	€	Ref. PP-H	€	Ref. PVDF	€	Ref. C-PVC	€
20	15	SPBDDK020DV	27,16	SPBDDK020DM	36,84	SPBDDK020DF	83,61	SPBDDK020DC	39,92
25	20	SPBDDK025DV	29,27	SPBDDK025DM	40,98	SPBDDK025DF	89,85	SPBDDK025DC	46,09
32	25	SPBDDK032DV	39,33	SPBDDK032DM	57,83	SPBDDK032DF	110,62	SPBDDK032DC	62,93
40	32	SPBDDK040DV	42,06	SPBDDK040DM	58,20	SPBDDK040DF	161,78	SPBDDK040DC	72,59
50	40	SPBDDK050DV	51,63	SPBDDK050DM	98,38	SPBDDK050DF	198,03	SPBDDK050DC	94,67
63	50	SPBDDK063DV	67,74	SPBDDK063DM	118,00	SPBDDK063DF	266,57	SPBDDK063DC	98,54
75	65	SPBDDK075DV	94,83	SPBDDK075DM	165,20	SPBDDK075DF	373,19	SPBDDK075DC	137,96

Cuerpo M-M DKD...

Posición 8.

Cuerpo DK con spigots para encolar macho serie métrica

d	DN	Ref. PVC-U	€	Ref. PP-H	€	Ref. PVDF	€	Ref. C-PVC	€
20	15	UNBDDK020V	28,83	UNBDDK020M	64,28	UNBDDK020F	88,68	UNBDDK020C	69,28
25	20	UNBDDK025V	32,21	UNBDDK025M	69,00	UNBDDK025F	98,88	UNBDDK025C	78,39
32	25	UNBDDK032V	43,65	UNBDDK032M	87,31	UNBDDK032F	122,79	UNBDDK032C	106,08
40	32	UNBDDK040V	48,64	UNBDDK040M	97,31	UNBDDK040F	180,96	UNBDDK040C	122,91
50	40	UNBDDK050V	65,22	UNBDDK050M	124,23	UNBDDK050F	208,06	UNBDDK050C	155,28
63	50	UNBDDK063V	83,35	UNBDDK063M	153,89	UNBDDK063F	281,82	UNBDDK063C	185,93

Cuerpo con enlace DKU...

Posición 8.

Cuerpo DK con enlaces para encolar hembra

Continúa en la página siguiente...

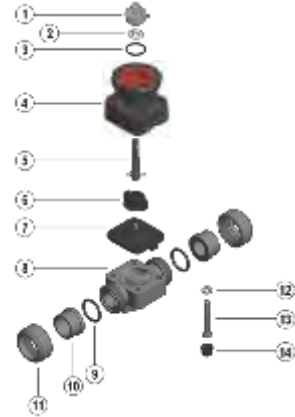

d	DN	Ref. PVC-U	€	Ref. PP-H	€	Ref. PVDF	€	Ref. C-PVC	€
20	15	FLBDDK020OV	72,06	FLBDDK020OM	101,48	FLBDDK020OF	192,24	FLBDDK020OC	121,77
25	20	FLBDDK025OV	81,46	FLBDDK025OM	111,05	FLBDDK025OF	201,48	FLBDDK025OC	142,65
32	25	FLBDDK032OV	102,10	FLBDDK032OM	141,05	FLBDDK032OF	233,31	FLBDDK032OC	169,33
40	32	FLBDDK040OV	126,36	FLBDDK040OM	171,40	FLBDDK040OF	370,15	FLBDDK040OC	207,84
50	40	FLBDDK050OV	159,33	FLBDDK050OM	213,82	FLBDDK050OF	414,86	FLBDDK050OC	251,08
63	50	FLBDDK063OV	198,17	FLBDDK063OM	268,74	FLBDDK063OF	534,04	FLBDDK063OV	312,21

Cuerpo con bridas DKO...
 Posición 8.

Cuerpo DK con bridas PN10/16 FF EN 558-1
 Disponible también con bridas ANSI 150 lbs. al mismo precio

d	DN	Ref.	€
20 ÷ 25	15 ÷ 20	CODK020025	14,41
32 ÷ 40	25 ÷ 32	CODK032040	15,74
50	40	COVMMN040050	20,09
63 ÷ 75	50 ÷ 65	COVMMN063	26,08

Compresor DK.
 Posición 6.

d	DN	Ref.	€
20 ÷ 25	15 ÷ 20	ATDKMN020025	55,03
32 ÷ 40	25 ÷ 32	ATDKMN032040	79,24
50	40	ATDKMN050	109,11
63 ÷ 75	50 ÷ 65	ATDKMN063075	133,28

Volante DK.
 Posiciones 1-2-3-4-5-6.

d	DN	Ref.	€
20 ÷ 40	15 ÷ 32	TCSDKMN02004	15,72
50	40	TCSDKMN050	19,90
63 ÷ 75	50 ÷ 65	TCSDKMN06307	22,72

Tapón transparente DK.
 Posiciones 1-2-3.

d	DN	Ref.	€
20 ÷ 25	15 ÷ 20	BSDK020025X	19,16
32 ÷ 40	25 ÷ 32	BSVM020032X	26,41
50	40	BSVM040050X	31,07
63 ÷ 75	50 ÷ 65	BSVM063X	38,92

Kit cierre DK.
 Posiciones 12-13-14.

compuesto por tornillos,
 tuercas y tapones protectores

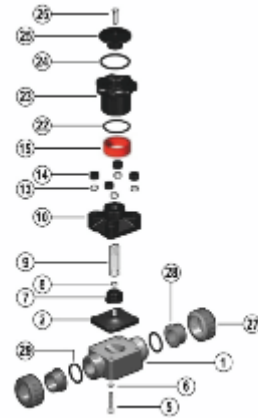

CM

Válvula de membrana compacta CM

d	DN	Ref. EPDM	€	Ref. FKM	€	Ref. PTFE	€
16 - 20	10 - 15	DIACM020E	19,76	DIACM020F	64,71	DIACM020P	59,23

Membrana CM.

Posición 2.

d	DN	Ref. PVC-U (EPDM / FKM)	€	Ref. PP-H (EPDM / FKM)	€	Ref. PVDF (EPDM / FKM)	€	Ref. C-PVC (EPDM / FKM)	€
16 - 20	10 - 15	SPBDCMQ020DV	19,85	SSPBDCMQ020DM	26,48	SPBDCMQ020DF	72,86	SPBDCMQ020DC	66,23

d	DN	Ref. PVC-U (PTFE)	€	Ref. PP-H (PTFE)	€	Ref. PVDF (PTFE)	€	Ref. C-PVC (PTFE)	€
16 - 20	10 - 15	SPBDCMQ020DV	33,11	SPBDCMQ020DM	39,71	SPBDCMQ020DF	86,08	SPBDCMQ020DC	79,46

Cuerpo M-M CMD...

Posición 1.

Cuerpo CM con spigots para membranas EPDM / FPM o PTFE

d	DN	Ref. PVC-U (EPDM / FKM)	€	Ref. PP-H (EPDM / FKM)	€	Ref. PVDF (EPDM / FKM)	€	Ref. C-PVC (EPDM / FKM)	€
16 - 20	10 - 15	UNBDCMQ020V	39,71	UNBDCMQ020M	46,33	UNBDCMQ020F	92,70	UNBDCMQ020C	86,29

d	DN	Ref. PVC-U (PTFE)	€	Ref. PP-H (PTFE)	€	Ref. PVDF (PTFE)	€	Ref. C-PVC (PTFE)	€
16 - 20	10 - 15	UNBDCMQ020V	52,97	UNBDCMQ020M	59,62	UNBDCMQ020F	105,95	UNBDCMQ020C	99,50

Cuerpo con enlace CMU...

Posición 1.

Cuerpo CM con enlaces para membranas EPDM / FKM o PTFE

Continúa en la página siguiente...

d	DN	Ref. PVC-U (EPDM / FKM)	€	Ref. PP-H (EPDM / FKM)	€	Ref. PVDF (EPDM / FKM)	€
16	10	SKBDCM016IV	30,82	SKBDCM016IM	43,52	SKBDCM016IF	72,86
20	15	SKBDCM020IV	30,82	SKBDCM020IM	43,52	SKBDCM020IF	72,86

d	DN	Ref. PVC-U (PTFE)	€	Ref. PP-H (PTFE)	€	Ref. PVDF (FKM)	€
16	10	SKBDCMQ016IV	44,05	SKBDCMQ016IM	57,50	SKBDCMQ016IF	86,08
20	15	SKBDCMQ020IV	44,05	SKBDCMQ020IM	57,50	SKBDCMQ020IF	86,08

Cuerpo H-H CMI...

Cuerpo CM H-H para membranas EPDM / FKM o PTFE

Posición 1.

Rh	DN	Ref. PVC-U (EPDM / FKM)	€	Ref. PP-H (EPDM / PTFE)	€	Ref. PVDF (EPDM / PTFE)	€
3/8"	10	TRBDCM038FV	30,82	TRBDCM038FM	43,52	TRBDCM038FF	72,86
1/2"	15	TRBDCM012FV	30,82	TRBDCM012FM	43,52	TRBDCM012FF	72,86

d	DN	Ref. PVC-U (PTFE)	€	Ref. PP-H (PTFE)	€	Ref. PVDF (PTFE)	€
3/8"	10	TRBDCMQ038FV	44,05	TRBDCMQ038FM	57,50	TRBDCMQ038FF	86,08
1/2"	15	TRBDCMQ012FV	44,05	TRBDCMQ012FM	57,50	TRBDCMQ012FF	86,08

Cuerpo H-H roscado CMF...

Cuerpo CM H-H roscado para membranas EPDM / FKM o PTFE

Posición 1.

d	DN	Ref. PVC-U	€	Ref. PP-H	€	Ref. PVDF	€	Ref. C-PVC	€
20	15	EFV100	1,59	EFM020	5,45	EFF020	17,11	EFC100	6,37

Tuercas CM

Tuercas para cuerpo CM con enlaces

Posición 27.

d	DN	Ref.	€
16-20	10-15	ATCMMN	78,67

Volante CM.

Posiciones 7-26.

d	DN	Ref.	€
16-20	10-15	BSCMX	16,05

Kit Cierre CM.

Posiciones 5-6.

Compuesto por tornillos, tuercas y tapones protectores

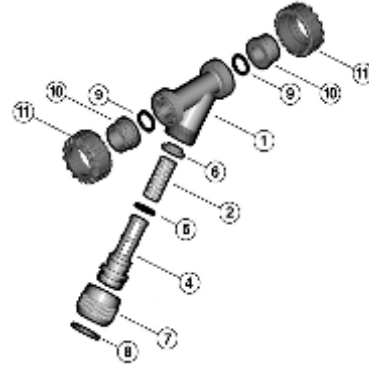

RV

Filtro inclinado RV DN10÷50.

d	DN	Ref. EPDM	€	Ref. FKM	€
16-20	10-15	SETRV020E	2,70	SETRV020F	21,93
25	20	SETRV025E	4,05	SETRV025F	29,59
32	25	SETRV032E	4,05	SETRV032F	29,59
40	32	SETRV040E	6,50	SETRV040F	47,13
50	40	SETRV050E	6,50	SETRV050F	47,13
63	50	SETRV063E	9,31	SETRV063F	67,96

Juego de juntas RV. Posiciones 5-9.

d	DN	Ref. PVC-U luz 0,3 mm.	€	Ref. PVC-U luz 0,5 mm.*	€	Ref. PVC-U luz 0,7 mm.	€	Ref. PVC-U luz 0,9 mm.	€
16-20	10-15	SCR10V020	5,51	SCR15V020	5,51	SCR20V020	5,51	SCR25V020	5,51
25	20	SCR10V025	6,05	SCR15V025	6,05	SCR20V025	3,75	SCR25V025	6,05
32	25	SCR10V032	6,35	SCR15V032	6,35	SCR20V032	6,35	SCR25V032	6,35
40	32	SCR10V040	7,74	SCR15V040	7,74	SCR20V040	7,74	SCR25V040	7,74
50	40	SCR10V050	7,74	SCR15V050	7,74	SCR20V050	7,74	SCR25V050	7,74
63	50	SCR10V063	9,12	SCR15V063	9,12	SCR20V063	9,12	SCR25V063	9,12

d	DN	Ref. PP luz 0,5 mm.**	€	Ref. Inox luz 0,3 mm.	€
16-20	10-15	SCR15M020	7,43	SCR07X020	6,75
25	20	SCR15M025	7,97	SCR07X025	7,23
32	25	SCR15M032	8,61	SCR07X032	7,74
40	32	SCR15M040	9,75	SCR07X040	9,12
50	40	SCR15M050	10,86	SCR07X050	9,31
63	50	SCR15M063	13,17	SCR07X063	11,02

Mallas RV. Posición 2.

** Estándar en los filtros de PP y C-PVC

d	DN	Ref. PVC-U	€	Ref. PVC transparente	€
16	10	SPBDRV016DV	16,59	SPBDRV016DT	19,69
20	15	SPBDRV020DV	18,13	SPBDRV020DT	19,69
25	20	SPBDRV025DV	22,49	SPBDRV025DT	24,13
32	25	SPBDRV032DV	24,13	SPBDRV032DT	24,13
40	32	SPBDRV040DV	35,31	SPBDRV040DT	35,31
50	40	SPBDRV050DV	49,40	SPBDRV050DT	49,40
63	50	SPBDRV063DV	72,93	SPBDRV063DT	80,90

Cuerpo M-M RVD. Posición 1.

Continúa en la página siguiente...

d	DN	Ref. PVC-U	€	Ref. PVC transparente	€	Ref. PP-H	€	Ref. C-PVC	€
16-20	10-15	UNBDRV020V	18,13	UNBDRV020T	19,69	UNBDRV020M	43,52	UNBDRV020C	59,04
25	20	UNBDRV025V	22,49	UNBDRV025T	24,13	UNBDRV025M	46,63	UNBDRV025C	65,28
32	25	UNBDRV032V	24,13	UNBDRV032T	24,13	UNBDRV032M	49,73	UNBDRV032C	69,95
40	32	UNBDRV040V	35,31	UNBDRV040T	35,31	UNBDRV040M	52,83	UNBDRV040C	90,15
50	40	UNBDRV050V	49,40	UNBDRV050T	49,40	UNBDRV050M	76,13	UNBDRV050C	128,98
63	50	UNBDRV063V	72,93	UNBDRV063T	80,90	UNBDRV063M	88,57	UNBDRV063C	131,22

Cuerpo con enlaces RVU... Posición 1.

d	DN	Ref.	€
16-20	10-15	SRRV020V	4,87
25	20	SRRV025V	7,25
32	25	SRRV032V	9,05
40	32	SRRV040V	11,18
50	40	SRRV050V	13,69
63	50	SRRV063V	16,22

Anillo cierre RV. Posición 8.

d	DN	Ref. PVC-U	€	Ref. PP-H	€	Ref. C-PVC	€
16-20	10-15	SURV020V	13,54	SURV020M	37,11	SURV020C	35,75
25	20	SURV025V	19,16	SURV025M	44,44	SURV025C	46,63
32	25	SURV032V	21,85	SURV032M	52,41	SURV032C	55,93
40	32	SURV040V	22,49	SURV040M	54,39	SURV040C	54,39
50	40	SURV050V	39,05	SURV050M	57,50	SURV050C	65,28
63	50	SURV063V	46,19	SURV063M	62,16	SURV063C	79,25

Soporte malla RV Posición 4.

d	DN	Ref. PVC-U	€	Ref. PP-H	€	Ref. C-PVC	€
16-20	10-15	NTVKD020V	7,15	NTVKD020M	9,53	NTVKD020C	13,69
25	20	NTVKD025V	13,54	NTVKD025M	18,22	NTVKD025C	25,08
32	25	NTVKD032V	16,37	NTVKD032M	21,95	NTVKD032C	30,77
40	32	NTVKD040V	17,59	NTVKD040M	23,94	NTVKD040C	34,19
50	40	NTVKD050V	20,80	NTVKD050M	28,19	NTVKD050C	39,90
63	50	NTVKD063V	31,50	NTVKD063M	43,10	NTVKD063C	61,52

Tuerca unión RV. Posición 11.

d	DN	Ref. PVC-U	€	Ref. PP-H	€	Ref. C-PVC	€
16-20	10-15	RRRV020V	7,04	RRRV020M	10,86	RRRV020C	15,54
25	20	RRRV025V	9,69	RRRV025M	13,69	RRRV025C	17,88
32	25	RRRV032V	11,71	RRRV032M	15,96	RRRV032C	18,65
40	32	RRRV040V	15,34	RRRV040M	18,82	RRRV040C	20,20
50	40	RRRV050V	22,44	RRRV050M	21,65	RRRV050C	26,41
63	50	RRRV063V	27,36	RRRV063M	29,61	RRRV063C	32,63

Anillo sujeción RV. Posición 6.

d	DN	Ref. PVC-U	€	Ref. PP-H	€	Ref. C-PVC	€
16-20	10-15	BNRV020V	18,26	BNRV020M	34,62	BNRV020C	40,40
25	20	BNRV025V	21,93	BNRV025M	46,59	BNRV025C	52,83
32	25	BNRV032V	25,29	BNRV032M	62,74	BNRV032C	65,28
40	32	BNRV040V	29,11	BNRV040M	68,61	BNRV040C	73,03
50	40	BNRV050V	34,08	BNRV050M	69,95	BNRV050C	77,71
63	50	BNRV063V	38,18	BNRV063M	71,47	BNRV063C	80,83

Tuerca cierre RV. Posición 7.

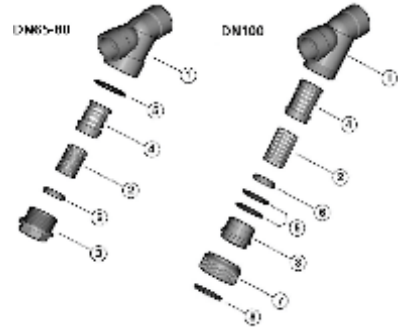

RV

Filtro inclinado RV DN65÷100.

d	DN	Ref. EPDM	€	Ref. FKM	€
75	65	SETRV075E	12,10	SETRV075F	87,73
90	80	SETRV090E	21,57	SETRV090F	156,79
110	100	SETRV110E	26,89	SETRV110F	194,15

Juego de juntas RV. Posición 5.

d	DN	Ref. PVC-U luz 0,3 mm.	€	Ref. PVC-U luz 0,5 mm. *	€	Ref. PVC-U luz 0,7 mm.	€	Ref. PVC-U luz 0,9 mm.	€
75	65	SCR10V075	18,50	SCR15V075	18,50	SCR20V075	18,50	SCR25V075	18,50
90	80	SCR10V090	23,03	SCR15V090	23,03	SCR20V090	23,03	SCR25V090	23,03
110	100	SCR10V110	34,19	SCR15V110	34,19	SCR20V110	34,19	SCR25V110	34,19

d	DN	Ref. PP luz 0,5 mm. **	€	Ref. Inox luz 0,3 mm.	€
75	65	SCR15M075	17,59	SCR07X075	36,33
90	80	SCR15M090	22,26	SCR07X090	42,33
110	100	SCR15M110	32,53	SCR07X110	60,38

* Estándar en los filtros de PVC-U

Mallas RV. Posición 2.

** Estándar en los filtros de PP y C-PVC

d	DN	Ref. PVC-U	€	Ref. PVC transparente	€	Ref. PP-H	€
75	65	SKBDRV075IV	132,92	SKBDRV075IT	179,55	SKBDRV075IM	298,37
90	80	SKBDRV090IV	172,82	SKBDRV090IT	260,55	SKBDRV090IM	437,63
110	100	SKBDRV110IV	293,62	SKBDRV110IT	398,89	SKBDRV110IM	582,25

Cuerpo H-H encolar RVI... Posición 1.

Rh	DN	Ref. PVC-U	€	Ref. PVC transparente	€
2½"	65	TRBDRV212FV	132,92	TRBDRV212FT	179,55
3"	80	TRBDRV300FV	172,82	TRBDRV300FT	260,55
4"	100	TRBDRV400FV	293,62	TRBDRV400FT	398,89

Cuerpo H-H roscar RVI... Posición 1.

d	DN	Ref. PVC-U	€	Ref. PP-H	€	d	DN	Ref.	€
110	100	BNRV110V	110,76	BNRV110M	157,35	110	100	SRRV110V	28,19

Tuerca cierre RV. Posición 7.

Anillo cierre RV. Posición 8.

d	DN	Ref. PVC-U	€	Ref. PP-H	€
75	65	RRRV075V	50,14	RRRV075M	37,59
90	80	RRRV090V	52,51	RRRV090M	47,85
110	100	RRRV110V	66,51	RRRV110M	94,07

Anillo sujeción RV. Posición 6.

Continúa en la página siguiente...

d	DN	Ref. PVC-U	€	Ref. PP-H	€
75	65	BORV075V	56,98	BORV075M	103,60
90	80	BORV090V	67,34	BORV090M	124,31
110	100	BORV110V	108,79	BORV110M	227,94

Tapón RV. Posición 3.

d	DN	Ref. PVC-U	€	Ref. PP-H	€
75	65	SURV075V	41,02	SURV075M	50,16
90	80	SURV090V	52,41	SURV090M	52,41
110	100	SURV110V	55,85	SURV110M	66,51

Soporte malla RV. Posición 4.

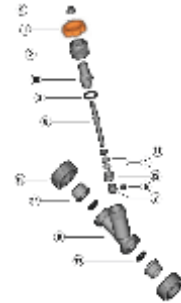

VV

Válvula de asiento inclinado VV DN10÷50.

d	DN	Ref. EPDM / PTFE	€	Ref. FKM / PTFE	€
16-20	10-15	SETVV020EP	4,59	SETVV020FP	22,28
25	20	SETVV025EP	5,66	SETVV025FP	26,35
32	25	SETVV032EP	8,75	SETVV032FP	31,69
40	32	SETVV040EP	11,64	SETVV040FP	45,88
50	40	SETVV050EP	11,64	SETVV050FP	51,08
63	50	SETVV063EP	11,64	SETVV063FP	72,12

Juego de juntas VV. Posiciones 3-4-13.

d	Ø	Ref.	€
16-20	10-15	HWVV020	7,43
25	20	HWVV025	8,10
32	25	HWVV032	12,95
40	32	HWVV040	15,72
50	40	HWVV050	20,20
63	50	HWVV063	23,32

Volante VV. Posiciones 1-9.

d	DN	Ref.	€
16	10	SPBDRV016DV	16,59
20	15	SPBDRV020DV	18,13
25	20	SPBDRV025DV	22,49
32	25	SPBDRV032DV	24,13
40	32	SPBDRV040DV	35,31
50	40	SPBDRV050DV	49,40
63	50	SPBDRV063DV	72,93

Cuerpo M-M VVD... Posición 6.

d	DN	Ref. PVC-U	€
16	10	UNBDRV020V	18,13
20	15	UNBDRV020V	18,13
25	20	UNBDRV025V	22,49
32	25	UNBDRV032V	24,13
40	32	UNBDRV040V	35,31
50	40	UNBDRV050V	49,40
63	50	UNBDRV063V	72,93

Cuerpo con enlaces VVU. Posición 6.

Ref. PVC-U / EPDM	€	Ref. PVC-U / FKM	€
ASVV020VE	27,95	ASVV020VF	32,15
ASVV020VE	27,95	ASVV020VF	32,15
ASVV025VE	33,70	ASVV025VF	38,74
ASVV032VE	39,26	ASVV032VF	45,12
ASVV040VE	60,12	ASVV040VF	69,15
ASVV050VE	76,05	ASVV050VF	87,43
ASVV063VE	98,41	ASVV063VF	113,15

Eje VV. Posiciones 5-7-8-10-11-12.

d	DN	Ref. PVC-U	€
16-20	10-15	NTVKD020V	7,15
25	20	NTVKD025V	13,54
32	25	NTVKD032V	16,37
40	32	NTVKD040V	17,59
50	40	NTVKD050V	20,80
63	50	NTVKD063V	31,50

Tuerca unión VV. Posición 15.

d	DN	Ref. PVC-U	€
16-20	10-15	BNRV020V	18,26
25	20	BNRV025V	21,93
32	25	BNRV032V	25,29
40	32	BNRV040V	29,11
50	40	BNRV050V	34,08
63	50	BNRV063V	38,18

Tuerca cierre VV. Posición 2.

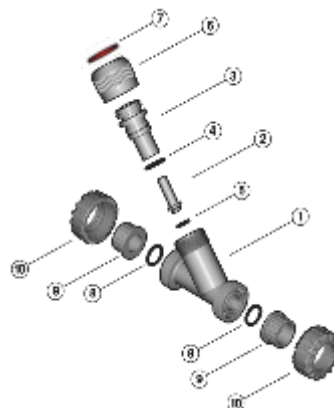

VR

Válvula anti retorno inclinada VR DN10÷50.

d	DN	Ref. EPDM	€	Ref. FKM	€
16-20	10-15	SETVR020E	1,34	SETVR020F	11,02
25	20	SETVR025E	1,71	SETVR025F	13,26
32	25	SETVR032E	2,34	SETVR032F	18,76
40	32	SETVR040E	3,26	SETVR040F	31,31
50	40	SETVR050E	3,60	SETVR050F	43,88
63	50	SETVR063E	3,97	SETVR063F	69,06

Juego de juntas VR.

Posiciones 4-5-6.

d	DN	Ref. PVC-U	€
16	10	SPBDRV016DV	16,59
20	15	SPBDRV020DV	18,13
25	20	SPBDRV025DV	22,49
32	25	SPBDRV032DV	24,13
40	32	SPBDRV040DV	35,31
50	40	SPBDRV050DV	49,40
63	50	SPBDRV063DV	72,93

Cuerpo M-M VRDV.

Posición 1.

d	DN	Ref.	€
16	10	SRRV020V	4,87
20	15	SRRV020V	4,87
25	20	SRRV025V	7,25
32	25	SRRV032V	9,05
40	32	SRRV040V	11,18
50	40	SRRV050V	13,69
63	50	SRRV063V	16,22

Anillo cierre VR.

Posición 7.

d	DN	Ref. PVC-U	€	Ref. PP-H	€
16-20	10-15	UNBDRV020V	18,13	UNBDRV020M	43,52
25	20	UNBDRV025V	22,49	UNBDRV025M	46,63
32	25	UNBDRV032V	24,13	UNBDRV032M	49,73
40	32	UNBDRV040V	35,31	UNBDRV040M	52,83
50	40	UNBDRV050V	49,40	UNBDRV050M	76,13
63	50	UNBDRV063V	72,93	UNBDRV063M	88,57

Cuerpo con enlaces VRU...

Posición 1.

Continúa en la página siguiente...

d	DN	Ref. PVC-U	€	Ref. PP-H	€
16-20	10-15	BOVR020V	19,45	BOVR020M	36,78
25	20	BOVR025V	20,31	BOVR025M	43,10
32	25	BOVR032V	22,05	BOVR032M	54,70
40	32	BOVR040V	30,95	BOVR040M	72,93
50	40	BOVR050V	40,07	BOVR050M	76,99
63	50	BOVR063V	59,62	BOVR063M	82,67

Porta pistón VR.
 Posición 3.

d	DN	Ref. PVC-U	€	Ref. PP-H	€
16-20	10-15	NTVKD020V	7,15	NTVKD020M	9,53
25	20	NTVKD025V	13,54	NTVKD025M	18,22
32	25	NTVKD032V	16,37	NTVKD032M	21,95
40	32	NTVKD040V	17,59	NTVKD040M	23,94
50	40	NTVKD050V	20,80	NTVKD050M	28,19
63	50	NTVKD063V	31,50	NTVKD063M	43,10

Tuerca unión VR.
 Posición 10.

d	DN	Ref. PVC-U	€	Ref. PP-H	€
16-20	10-15	BNRV020V	18,26	BNRV020M	34,62
25	20	BNRV025V	21,93	BNRV025M	46,59
32	25	BNRV032V	25,29	BNRV032M	62,74
40	32	BNRV040V	29,11	BNRV040M	68,61
50	40	BNRV050V	34,08	BNRV050M	69,95
63	50	BNRV063V	38,18	BNRV063M	71,47

Tuerca cierre VR.
 Posición 6.

d	DN	Ref. PVC-U/EPDM	€	Ref. PVC-U/FKM	€	Ref. PP-H/EPDM	€	Ref. PP-H/FKM	€
16-20	10-15	PSVR020VE	17,24	PSVR020VF	17,24	PSVR020ME	17,24	PSVR020MF	17,24
25	20	PSVR025VE	20,53	PSVR025VF	20,53	PSVR025ME	20,53	PSVR025MF	20,53
32	25	PSVR032VE	22,26	PSVR032VF	23,84	PSVR032ME	22,26	PSVR032MF	25,38
40	32	PSVR040VE	26,30	PSVR040VF	29,41	PSVR040ME	26,30	PSVR040MF	32,53
50	40	PSVR050VE	32,96	PSVR050VF	36,22	PSVR050ME	32,96	PSVR050MF	39,17
63	50	PSVR063VE	45,99	PSVR063VF	50,28	PSVR063ME	45,99	PSVR063MF	52,23

Pistón VR.
 Posiciones 2-5

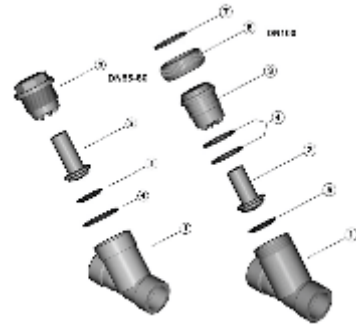

VR

Válvula anti retorno inclinada VR DN65÷100.

d	DN	Ref. EPDM	€	Ref. FKM	€
75	65	SETVR075E	13,46	SETVR075F	112,97
90	80	SETVR090E	15,98	SETVR090F	142,61
110	100	SETVR110E	28,51	SETVR110F	153,53

Juego de juntas VR.
 Posiciones 4-5.

d	DN	Ref. PVC-U	€	Ref. PP-H	€
75	65	BOVR075V	128,98	BOVR075M	144,74
90	80	BOVR090V	167,75	BOVR090M	238,28
110	100	BOVR110V	243,86		

Porta pistón VR.
 Posición 3.

d	DN	Ref. PVC-U	€	Ref. PP-H	€	Rh	DN	Ref. PVC-U	€
75	65	SKBDVR075IV	132,92	SKBDVR075IM	298,37	2 1/2"	65	TRBDVR212FV	132,92
90	80	SKBDVR090IV	172,82	SKBDVR090IM	437,63	3"	80	TRBDVR300FV	172,82
110	100	SKBDVR110IV	293,62			4"	100	TRBDVR400FV	293,62

Cuerpo H-H encolar VRI...
 Posición 1.

Cuerpo H-H roscar VRFV...
 Posición 1.

d	DN	Ref. PVC-U/EPDM	€	Ref. PVC-U/FKM	€	Ref. PP-H/EPDM	€	Ref. PP-H/FKM	€
75	65	PSVR075VE	108,37	PSVR075VF	131,84	PSVR075ME	142,71	PSVR075MF	173,22
90	80	PSVR090VE	119,09	PSVR090VF	199,75	PSVR090ME	198,31	PSVR090MF	284,90
110	100	PSVR110VE	159,03	PSVR110VF	266,72				

Pistón VR.
 Posición 2-5

d	DN	Ref.	€
110	100	SRRV110V	28,19

d	DN	Ref. PVC-U	€
110	100	BNRV110V	110,76

Anillo cierre VR.
 Posición 7.

Tuerca cierre VR.
 Posición 6.

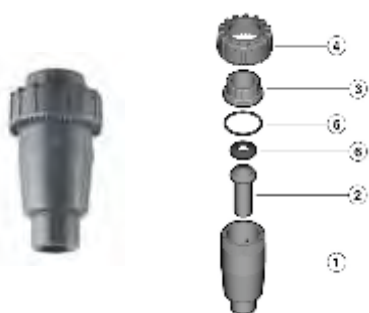

VA

Válvula de purgabola / ventosa VA.

d	DN	Ref. EPDM	€
16-20	10-15	SETVZA020E	1,71
25	20	SETVZA025E	2,34
32	25	SETVZA032E	3,08
40	32	SETVZA040E	4,78
50	40	SETVZA050E	9,85
63	50	SETVZA063E	11,64

Juego de juntas VA-VZ.
 Posiciones 5-6.

d	DN	Ref. PVC-U/EPDM	€
16-20	10-15	PSVA020VE	16,37
25	20	PSVA025VE	18,04
32	25	PSVA032VE	19,58
40	32	PSVA040VE	23,74
50	40	PSVA050VE	29,71
63	50	PSVA063VE	41,56

Pistón VA.
 Posiciones 2-6.



VZ

Válvula de fondo / pie VZ.

d	DN	Ref. PVC-U	€
16-20	10-15	NTVKD020V	7,15
25	20	NTVKD025V	13,54
32	25	NTVKD032V	16,37
40	32	NTVKD040V	17,59
50	40	NTVKD050V	20,80
63	50	NTVKD063V	31,50

Tuerca unión VA-VZ.
 Posición 4.

d	DN	Ref. PVC-U/EPDM	€
16-20	10-15	PSVR020VE	17,24
25	20	PSVR025VE	20,53
32	25	PSVR032VE	22,26
40	32	PSVR040VE	26,30
50	40	PSVR050VE	32,96
63	50	PSVR063VE	45,99

Pistón VZ.
 Posiciones 2-6.

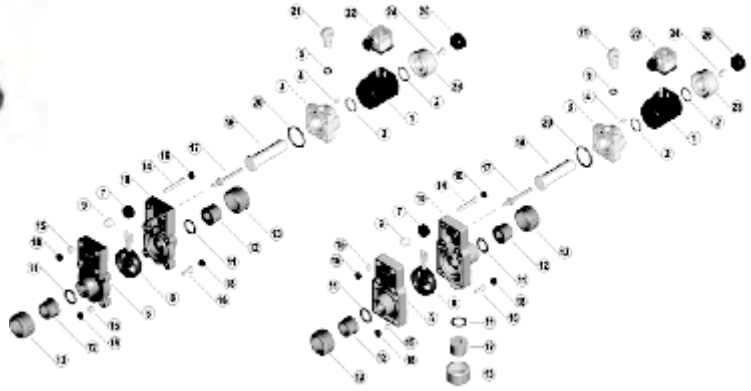

S1/S2

Válvulas de solenoide S1 y S2.

I

Voltaje	Ref. para válvula S1	€	Ref. para válvula S2	€
24 V DC	SLS1024VDC	88,48	SLS2024VDC	138,73
24 V AC	SLS1024VAC	88,48	SLS2024VAC	138,73
* 110 V AV	SLS1110VAC	88,48	SLS2110VAC	138,73
230 V AC	SLS1230VAC	88,48	SLS2230VAC	138,73

Solenoide.
Posición 1.

* Disponible bajo pedido

Voltaje	Ref.	€
24 V DC	CNS024VDC	31,07
24 V AC	CNS024VAC	31,07
110 V AV	CNS110VAC	31,07
230 V AC	CNS230VAC	31,07

Válvula	Ref.	€
S1	SETS1	1,74
S2	SETS2	2,41

Juego juntas secundario.
Posiciones 2-5-20.

Conector VA.
Posiciones 22.

Válvula	Ref. EPDM	€	Ref. FKM	€
S1	SHS1E	25,08	SHS1F	49,42
S2	SHS2E	27,23	SHS2F	62,68

Obturador.
Posición 8.

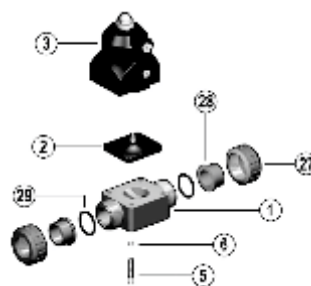

CM/CP

Válvulas de membrana compactas neumáticas CM/CP.

d	DN	Material	Ref. Normalmente cerrado NC	€	Ref. Normalmente abierto NO	€	Ref. Doble efecto DE	€
16-20	10-15	EPDM/FKM	ATCMNC	139,83	ATCMNO	139,83	ATCMDA	139,83
16-20	10-15	PTFE	ATCMNCPQ	Consultar	ATCMNOPQ	Consultar	ATCMDAPPQ	Consultar

Actuador neumático CM/CP.

Posición 3.

Para otras piezas de recambio consultar esta misma tarifa (válvulas de membrana manuales)

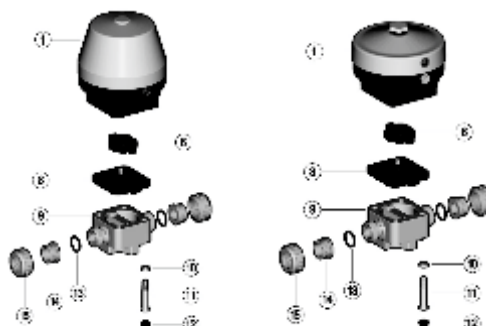

VM/CP

Válvulas de membrana neumáticas VM/CP.

d	DN	Ref. Normalmente cerrado NC	€	Ref. Normalmente abierto NO	€	Ref. Doble efecto DE	€
90	80	ATVMNC075090	1.118,90	ATVMNO075090	699,32	ATVMDA075090	1.165,54
110	100	ATVMNC110	1.442,65	ATVMNO110	1.017,91	ATVMDA110	1.165,54

Actuador neumático VM/CP.

Posiciones 1-6.

d	DN	Ref.	€
90	80	COVMMN075090	101,02
110	100	COVMMN110	108,79

Compresor VM/CP.

Posición 6.



DK/CP

Válvula de membrana neumática DK/CP

d	DN	Ref. EPDM	€	Ref. FPM	€	Ref. PTFE	€	Ref. NBR	€
20	15	DIA025E	23,07	DIA025F	75,23	DIADK025P	89,41	DIA025N	23,07
25	20	DIA025E	23,07	DIA025F	75,23	DIADK025P	89,41	DIA025N	23,07
32	25	DIA032E	24,09	DIA032F	83,31	DIADK032P	101,97	DIA032N	24,09
40	32	DIA032E	24,09	DIA032F	83,31	DIADK032P	101,97	DIA032N	24,09
* 50	40	DIA050E	29,59	DIA050F	141,46	DIADK050P	168,90	DIA050N	29,59
* 63	50	DIA063E	43,88	DIA063F	201,81	DIADK063P	207,20	DIA063N	43,88
* 75	65	DIA063E	43,88	DIA063F	201,81	DIADK063P	207,20	DIA063N	43,88

Membrana DK/CP. Posición 7.

d	DN	Ref. PVC-U	€	Ref. C-PVC	€	Ref. PP-H	€	Ref. PVDF	€
20	15	SPBDDK020DV	27,16	SPBDDK020DC	39,92	SPBDDK020DM	36,84	SPBDDK020DF	83,61
25	20	SPBDDK025DV	29,27	SPBDDK025DC	46,09	SPBDDK025DM	40,98	SPBDDK025DF	89,85
32	25	SPBDDK032DV	39,33	SPBDDK032DC	62,93	SPBDDK032DM	57,83	SPBDDK032DF	110,62
40	32	SPBDDK040DV	42,06	SPBDDK040DC	72,59	SPBDDK040DM	58,20	SPBDDK040DF	161,78
* 50	40	SPBDDK050DV	51,63	SPBDDK063DC	94,67	SPBDDK063DM	98,38	SPBDDK050DF	198,03
* 63	50	SPBDDK063DV	67,74	SPBDDK050DC	98,54	SPBDDK050DM	118,00	SPBDDK063DF	266,57
* 75	65	SPBDDK075DV	94,83	SPBDDK075DC	137,96	SPBDDK075DM	165,20	SPBDDK075DF	373,19

Cuerpo M-M DK/CP. Posición 8.

d	DN	Ref. PVC-U	€	Ref. C-PVC	€	Ref. PP-H	€	Ref. PVDF	€
20	15	UNBDDK020V	28,83	UNBDDK020C	69,28	UNBDDK020M	64,28	UNBDDK020F	88,68
25	20	UNBDDK025V	32,21	UNBDDK025C	78,39	UNBDDK025M	69,00	UNBDDK025F	98,88
32	25	UNBDDK032V	43,65	UNBDDK032C	106,08	UNBDDK032M	87,31	UNBDDK032F	122,79
40	32	UNBDDK040V	48,64	UNBDDK040C	122,91	UNBDDK040M	97,31	UNBDDK040F	180,96
* 50	40	UNBDDK050V	65,22	UNBDDK050C	155,28	UNBDDK050M	124,23	UNBDDK050F	208,06
* 63	50	UNBDDK063V	83,35	UNBDDK063C	185,93	UNBDDK063M	153,89	UNBDDK063F	281,82

Cuerpo con enlaces DKU/CP. Posición 8.

d	DN	Ref. PVC-U	€	Ref. C-PVC	€	Ref. PP-H	€	Ref. PVDF	€
20	15	FLBDDK020OV	72,06	FLBDDK020OC	121,77	FLBDDK020OM	101,48	FLBDDK020OF	192,24
25	20	FLBDDK025OV	81,46	FLBDDK025OC	142,65	FLBDDK025OM	111,05	FLBDDK025OF	201,48
32	25	FLBDDK032OV	102,10	FLBDDK032OC	169,33	FLBDDK032OM	141,05	FLBDDK032OF	233,31
40	32	FLBDDK040OV	126,36	FLBDDK040OC	207,84	FLBDDK040OM	171,40	FLBDDK040OF	370,15
* 50	40	FLBDDK050OV	159,33	FLBDDK050OC	251,08	FLBDDK050OM	213,82	FLBDDK050OF	414,86
* 63	50	FLBDDK063OV	198,17	FLBDDK063OC	312,21	FLBDDK063OM	268,74	FLBDDK063OF	534,04

Cuerpo con bridas DIN DKO/CP. Posición 8.

d	DN	Ref. PVC-U	€	Ref. C-PVC	€	Ref. PP-H	€	Ref. PVDF	€
1/2"	15	FLBDDK012OAV	74,95	FLBDDK012OAC	126,66	FLBDDK012OAM	105,57	FLBDDK012OAF	199,97
3/4"	20	FLBDDK034OAV	84,78	FLBDDK034OAC	148,38	FLBDDK034OAM	115,52	FLBDDK034OAF	209,59
1"	25	FLBDDK100OAV	106,21	FLBDDK100OAC	176,15	FLBDDK100OAM	146,72	FLBDDK100OAF	242,67
1 1/4"	32	FLBDDK114OAV	131,44	FLBDDK114OAC	216,18	FLBDDK114OAM	178,27	FLBDDK114OAF	385,02
* 1 1/2"	40	FLBDDK112OAV	165,75	FLBDDK112OAC	261,17	FLBDDK112OAM	222,42	FLBDDK112OAF	431,51
* 2"	50	FLBDDK200OAV	206,10	FLBDDK200OAC	324,75	FLBDDK200OAM	279,54	FLBDDK200OAF	555,47

Cuerpo con bridas ANSI 150 lbs DKO/CP. Posición 8.

d	DN	Referencia	€	d	DN	Ref. NC	€	Ref. NO	€	Ref. DE	€
20	15	CODK020025	14,41	20	15	ATDKNC020025	177,89	ATDKNO020025	Consultar	ATDKDA020025	114,02
25	20	CODK020025	14,41	25	20	ATDKDA020025	114,02	ATDKNO020025	Consultar	ATDKDA020025	114,02
32	25	CODK032040	15,74	32	25	ATDKDA032040	Consultar	ATDKNO032040	Consultar	ATDKDA032040	Consultar
40	32	CODK032040	15,74	40	32	ATDKDA032040	Consultar	ATDKNO032040	Consultar	ATDKDA032040	Consultar
50	40	COVMMN040050	20,09	50	40	ATDKDA050	332,37	ATDKNO050	226,80	ATDKDA050	206,18
63	50	COVMMN063	26,08	63	50	ATDKDA063075	266,12	ATDKNO063075	292,72	ATDKDA063075	266,12
75	65	COVMMN063	26,08	75	65	ATDKDA063075	266,12	ATDKNO063075	292,72	ATDKDA063075	266,12

Compresor DK. Posición 6.

Actuador neumático DK/CP. Posiciones 1-2-3-4-6

d	DN	Referencia	€	d	DN	Referencia	€
20	15	BSDK020025X	19,16	20÷75	15÷65	TCSDKCP020075	Consultar
25	20	BSDK020025X	19,16	Tapón transparente DK. Posiciones 1-2-3			
32	25	BSDK032040X	25,15				
40	32	BSDK032040X	25,15				
50	40	BSDK050X	31,71				
63	50	BSDK063075X	39,69				
75	65	BSDK063075X	39,69				

Cierres DK. Posiciones 12-13-14



DKB/CP

Válvula de membrana neumática DKB/CP

d	DN	Ref. EPDM	€
20	15	DIA025E	23,07
25	20	DIA025E	23,07
32	25	DIA032E	24,09
40	32	DIA032E	24,09
50	40	DIA050E	29,59
63	50	DIA063E	43,88
75	65	DIA063E	43,88

d	DN	Ref. EPDM	€
20	15	ATDKBNC020025	195,38
25	20	ATDKBNC020025	195,38
32	25	ATDKBNC032040	207,85
40	32	ATDKBNC032040	207,85
50	40	ATDKBNC050	274,31
63	50	ATDKBNC063075	384,23
75	65	ATDKBNC063075	384,23

Membrana DKB/CP. Posición 7.

Actuador neumático DKB/CP. Posiciones 1-6.

d	DN	Ref. PVC-U	€	Ref. C-PVC	€	Ref. PP-H	€
25	15	SPBDDK020DV	27,16	SPBDDK020DC	39,92	SPBDDK020DM	36,84
32	25	SPBDDK025DV	29,27	SPBDDK040DC	46,09	SPBDDK025DM	40,98
50	40	SPBDDK032DV	39,33	SPBDDK032DC	62,93	SPBDDK032DM	57,83
40	32	SPBDDK040DV	42,06	SPBDDK025DC	72,59	SPBDDK040DM	58,20
20	20	SPBDDK050DV	51,63	SPBDDK063DC	94,67	SPBDDK050DM	98,38
63	50	SPBDDK063DV	67,74	SPBDDK050DC	98,54	SPBDDK063DM	118,00
75	65	SPBDDK075DV	94,83	SPBDDK075DC	137,96	SPBDDK075DM	165,20

Cuerpo M-M DKB/CP. Posición 8.

d	DN	Ref. PVC-U	€	Ref. C-PVC	€	Ref. PP-H	€
20	15	UNBDDK020V	28,83	UNBDDK020C	69,28	UNBDDK020M	64,28
25	20	UNBDDK025V	32,21	UNBDDK025C	78,39	UNBDDK025M	69,00
32	25	UNBDDK032V	43,65	UNBDDK032C	106,08	UNBDDK032M	87,31
40	32	UNBDDK040V	48,64	UNBDDK040C	122,91	UNBDDK040M	97,31
50	40	UNBDDK050V	65,22	UNBDDK050C	155,28	UNBDDK050M	124,23
63	50	UNBDDK063V	83,35	UNBDDK063C	185,93	UNBDDK063M	153,89

Cuerpo con enlaces DKBU/CP. Posición 8.

d	DN	Ref. PVC-U	€	Ref. C-PVC	€	Ref. PP-H	€
20	15	FLBDDK020OV	72,06	FLBDDK020OC	121,77	FLBDDK020OM	101,48
25	20	FLBDDK025OV	81,46	FLBDDK025OC	142,65	FLBDDK032OM	111,05
32	25	FLBDDK032OV	102,10	FLBDDK032OC	169,33	FLBDDK025OM	141,05
40	32	FLBDDK040OV	126,36	FLBDDK040OC	207,84	FLBDDK050OM	171,40
50	40	FLBDDK050OV	159,33	FLBDDK050OC	251,08	FLBDDK040OM	213,82
63	50	FLBDDK063OV	198,17	FLBDDK063OC	312,21	FLBDDK063OM	268,74

Cuerpo con bridas DIN DKBO/CP. Posición 8.

d	DN	Ref. PVC-U	€	Ref. C-PVC	€	Ref. PP-H	€
½"	15	FLBDDK012OAV	74,95	FLBDDK012OAC	126,66	FLBDDK012OAM	105,57
¾"	20	FLBDDK034OAV	84,78	FLBDDK034OAC	148,38	FLBDDK034OAM	115,52
1"	25	FLBDDK100OAV	106,21	FLBDDK100OAC	176,15	FLBDDK100OAM	146,72
1 ¼"	32	FLBDDK114OAV	131,44	FLBDDK114OAC	216,18	FLBDDK114OAM	178,27
1 ½"	40	FLBDDK112OAV	165,75	FLBDDK112OAC	261,17	FLBDDK112OAM	222,42
2"	50	FLBDDK200OAV	206,10	FLBDDK200OAC	324,75	FLBDDK200OAM	279,54

Cuerpo con bridas ANSI 150 lbs DKBO/CP. Posición 8.

d	DN	Ref.	€
20	15	BSDK020025X	19,16
25	20	BSDK020025X	19,16
32	25	BSDK032040X	25,15
40	32	BSDK032040X	25,15
50	40	BSDK050X	31,71
63	50	BSDK063075X	39,69
75	65	BSDK063075X	39,69

Mcierres DKB.. Posición 12-13-14.

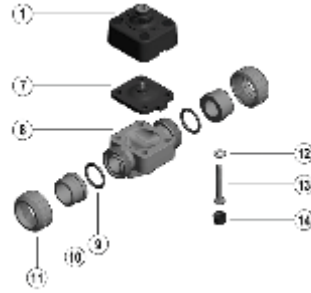

DKD/CP

Válvulas de membrana neumática DKD/CP.

d	DN	Ref. EPDM	€
20	15	DIADKD025E	Consultar
25	20	DIADKD025E	Consultar
32	25	DIA032E	24,09
40	32	DIA032E	24,09
50	40	DIA050E	29,59
63	50	DIA063E	43,88
75	65	DIA063E	43,88

Membrana DKD / CP.

Posición 7.

d	DN	Ref. PVC-U	€
20	15	SPBDDK020DV	27,16
25	20	SPBDDK025DV	29,27
32	25	SPBDDK032DV	39,33
40	32	SPBDDK040DV	42,06
50	40	SPBDDK050DV	51,63
63	50	SPBDDK063DV	67,74
75	65	SPBDDK075DV	94,83

Cuerpo DKDD...

Posición 8.

M-M encolar

d	DN	Ref. PVC-U	€
20	15	UNBDDK020V	28,83
25	20	UNBDDK025V	32,21
32	25	UNBDDK032V	43,65
40	32	UNBDDK040V	48,64
50	40	UNBDDK050V	65,22
63	50	UNBDDK063V	83,35

Cuerpo DKDU...

Posición 8.

H-H encolar con enlaces

d	DN	Ref.	€
20÷25	15÷20	BODKD020025	25,80
32÷40	25÷32	BODKD032040	27,49
50	40	BODKD050	45,76
63÷75	50÷65	BODKD063075	66,59

Cubierta DKD/CP

Posición 1.

d	DN	Ref.	€
20÷25	15÷20	BSDK020025X	19,16
32÷40	25÷32	BSVM020032X	26,41
50	40	BSVM040050X	31,07
63÷75	50÷65	BSVM063X	38,92

Cierres DKD/CP...

Posiciones 12-13-14.



INDUSTRIA

Recambios Uniones 3 piezas



Parte LOCA



Parte FIJA



TUERCA



PVC-U



PP-H



C-PVC



PVDF

Bl...

Uniones 3 piezas en PVC-U.

d	Ref.	€
16	QBIV016	0,50
20	QBIV020	0,50
25	QBIV025	0,51
32	QBIV032	0,65
40	QBIV040	0,73
50	QBIV050	1,02
63	QBIV063	1,34
75	QBIV075	3,20
90	QBIV090	4,06
110	QBIV110	7,91

Parte loca. *H* encolar.

d	Ref.	€
16	FBIV016	0,65
20	FBIV020	0,65
25	FBIV025	0,77
32	FBIV032	1,11
40	FBIV040	1,30
50	FBIV050	1,77
63	FBIV063	2,64
75	FBIV075	7,32
90	FBIV090	9,44
110	FBIV110	13,98

Parte fija. *H* encolar.

d	Ref.	€
16	EFV034	1,18
20	EFV100	1,59
25	EFV114	1,85
32	EFV112	1,99
40	EFV200	2,32
50	EFV214	2,00
63	EFV234	3,59
75	EFV312	15,10
90	EFV400	20,94
110	EFV500	27,49

Tuerca. *H* rosca.

Rh	Ref.	€
3/8"	QBFV038	3,19
1/2"	QBFV012	3,19
3/4"	QBFV034	3,75
1"	QBFV100	6,92
1 1/4"	QBFV114	7,21
1 1/2"	QBFV112	8,47
2"	QBFV200	11,15

Parte loca. *H* rosca.

Rh	Ref.	€
3/8"	FBFV038	3,42
1/2"	FBFV012	4,15
3/4"	FBFV034	4,64
1"	FBFV100	6,21
1 1/4"	FBFV114	7,59
1 1/2"	FBFV112	11,01
2"	FBFV200	14,30

Parte fija. *H* rosca.

Uniones 3 piezas en PP-H.

d	Ref.	€
20	QBIGM020	3,03
25	QBIGM025	3,08
32	QBIGM032	3,28
40	QBIGM040	4,06
50	QBIGM050	4,86
63	QBIGM063	5,17

Parte loca. *H* soldar.

d	Ref.	€
20	FBIGM020	5,91
25	FBIGM025	6,50
32	FBIGM032	7,43
40	FBIGM040	9,71
50	FBIGM050	13,78
63	FBIGM063	18,31

Parte fija. *H* soldar.

d	Ref.	€
20	EFGM100	5,79
25	EFGM114	6,00
32	EFGM112	6,96
40	EFGM200	8,89
50	EFGM214	13,77
63	EFGM234	22,20

Tuerca. *H* rosca.

Continúa en la página siguiente...



Uniones 3 piezas en C-PVC.

d	Ref.	€
16	QBIC016	7,17
20	QBIC020	7,12
25	QBIC025	8,33
32	QBIC032	10,83
40	QBIC040	13,28
50	QBIC050	17,68
63	QBIC063	23,60

Parte loca. *H encolar.*

d	Ref.	€
16	FBIC016	5,94
20	FBIC020	6,02
25	FBIC025	6,90
32	FBIC032	10,09
40	FBIC040	12,91
50	FBIC050	17,05
63	FBIC063	20,33

Parte fija. *H encolar.*

d	Ref.	€
16	EFC034	5,72
20	EFC100	6,37
25	EFC114	7,38
32	EFC112	10,70
40	EFC200	12,17
50	EFC214	19,93
63	EFC234	28,43

Tuerca. *H roscar.*

Rh	Ref.	€
3/8"	QBFC038	Consultar
1/2"	QBFC012	12,12
3/4"	QBFC034	13,46
1"	QBFC100	15,82
1 1/4"	QBFC114	18,53
1 1/2"	QBFC112	20,92
2"	QBFC200	28,32

Parte loca. *H roscar.*

Rh	Ref.	€
3/8"	FBFC038	6,83
1/2"	FBFC012	8,19
3/4"	FBFC034	9,34
1"	FBFC100	12,55
1 1/4"	FBFC114	14,81
1 1/2"	FBFC112	20,53
2"	FBFC200	28,49

Parte fija. *H roscar.*

Uniones 3 piezas en PVDF.

d	Ref.	€
20	QBIGF020	9,06
25	QBIGF025	11,72
32	QBIGF032	13,06
40	QBIGF040	16,66
50	QBIGF050	18,98
63	QBIGF063	26,33

Parte loca. *H soldar.*

d	Ref.	€
20	FBIGF020	13,44
25	FBIGF025	17,58
32	FBIGF032	19,36
40	FBIGF040	24,92
50	FBIGF050	33,62
63	FBIGF063	52,69

Parte fija. *H soldar.*

d	Ref.	€
20	EFGF100	14,93
25	EFGF114	20,38
32	EFGF112	25,27
40	EFGF200	34,74
50	EFGF214	50,67
63	EFGF234	78,78

Tuerca. *H roscar.*

Continúa en la página siguiente...

Uniones 3 piezas en **Latón**.



Rm	Ref.	€
3/8"	QBRO038	6,77
1/2"	QBRO012	7,24
3/4"	QBRO034	11,30
1"	QBRO100	14,55
1 1/4"	QBRO114	21,29
1 1/2"	QBRO112	25,16
2"	QBRO200	35,33

Parte loca. *M roscar.*



Rh	Ref.	€
3/8"	QBFO038	5,91
1/2"	QBFO012	6,35
3/4"	QBFO034	11,60
1"	QBFO100	12,42
1 1/4"	QBFO114	16,17
1 1/2"	QBFO112	20,12
2"	QBFO200	25,79

Parte loca. *H roscar.*

Uniones 3 piezas en **Inox 316L**.



Rm	Ref.	€
3/8"	QBRX038	23,26
1/2"	QBRX012	27,33
3/4"	QBRX034	29,91
1"	QBRX100	32,08
1 1/4"	QBRX114	47,15
1 1/2"	QBRX112	61,95
2"	QBRX200	78,38

Parte loca. *M roscar.*



Rh	Ref.	€
3/8"	QBFX038	21,79
1/2"	QBFX012	24,22
3/4"	QBFX034	28,41
1"	QBFX100	31,16
1 1/4"	QBFX114	43,38
1 1/2"	QBFX112	48,52
2"	QBFX200	61,43

Parte loca. *H roscar.*

Juntas para uniones 3 piezas .



d	Ref.	€
16	OR3062E	1,41
20	OR4081E	4,01
25	OR4112E	1,44
32	OR4131E	2,05
40	OR6162E	2,18
50	OR6187E	2,32
63	OR6237E	2,53
75	OR6300E	5,07
90	OR6362E	7,58
110	OR6450E	10,01

Junta tórica. *en EPDM.*



d	Ref.	€
16	OR3062F	3,46
20	OR4081F	10,61
25	OR4112F	2,00
32	OR4131F	5,65
40	OR6162F	8,33
50	OR6187F	9,50
63	OR6237F	10,61
75	OR6300F	19,87
90	OR0185F	21,78
110	OR6450F	36,21

Junta tórica. *en FKM.*



FC/FS

Flujómetros cortos (FC) y largos (FS).

d	DN	Ref. SS para líquidos	€	Ref. SS + M para líquidos	€	Ref. PP para líquidos	€	Ref. PP + M para líquidos	€
16	10	FL016X	29,88	FL016XM	92,35	FL016M	29,88	FL016MM	92,35
20	15	FL020X	32,58	FL020XM	105,93	FL020M	32,58	FL020MM	105,93
25	20	FL025X	36,68	FL025XM	109,99	FL025M	36,67	FL025MM	109,99
32	25	FL032X	40,74	FL032XM	135,78	FL032M	40,74	FL032MM	135,78
40	32	FL040X	76,05	FL040XM	176,53	FL040M	76,05	FL040MM	176,53
50	40	FL050X	95,06	FL050XM	203,68	FL050M	95,06	FL050MM	203,68
63	50	FL063X	149,37	FL063XM	271,59	FL063M	149,37	FL063MM	271,59
75	65	FL075X	306,88	FL075XM	573,03	FL075M	306,88	FL075MM	573,03
75 cuerpo 68	65	FL07568X	306,88	FL07568XM	573,03	FL07568M	306,88	FL07568MM	573,03

d	DN	Ref. PP para gases	€	Ref. PP + M para gases	€
16	10	FL016GM	29,88	FL016GMM	92,35
20	15	FL020GM	32,58	FL020GMM	105,93
25	20	FL025GM	36,68	FL025GMM	109,99
32	25	FL032GM	40,74	FL032GMM	135,78
40	32	FL040GM	76,05	FL040GMM	176,53
50	40	FL050GM	95,06	FL050GMM	203,68
63	50	FL063GM	149,37	FL063GMM	271,59
75	65	FL075GM	306,88	FL075GMM	573,03

Flotador FC y FS. Posición 8.

d	DN	Ref. Serie FC	€	Ref. Serie FS	€
16	10	STFC016P	14,12		
20	15	STFC020P	14,12		
25	20	STFC025P	14,64	STFS025P	14,64
32	25	STFC032P	16,03	STFS032P	16,03
40	32			STFS040P	23,09
50	40			STFS050P	25,23
63	50			STFS063P	31,50
75	65			STFS075PINF	59,73
75 cuerpo 68	65			STFS075PSUP	59,73

Topes flotador FC y FS. Posición 7.

Se necesita 1 pieza para la serie FC y 2 piezas para la serie FS (precio por unidad)

Continúa en la página siguiente...

Ref.	Descripción	€
VFI01	Indicadores visuales para FS y FC d 32 (2 piezas)	2,70
VFI02	Indicadores visuales para FC 16, 20 y d 25 (2 piezas)	2,70

Indicadores visuales de caudal FC y FS.

Posición 2.



|



|

d	Ref.	€
16	OR3062E	1,41
20	OR4081E	4,01
25	OR4112E	1,44
32	OR4131E	2,05
40	OR0150E	2,93
50	OR4200E	2,59
63	OR4275E	4,03
75	OR6325E	6,52

Junta tórica en EPDM.

Posición 6.

d	Ref.	€
16	OR3062F	3,46
20	OR4081F	10,61
25	OR4112F	2,00
32	OR4131F	5,65
40	OR0150F	11,12
50	OR4200F	8,67
63	OR4275F	13,80
75	OR6325F	22,15

Junta tórica en FKM.

Posición 6.

AENOR

Certificado del Sistema de Gestión de la Calidad



ER-0288/1996

AENOR certifica que la organización

ALIXIS IBERIA, S.A.U.

dispone de un sistema de gestión de la calidad conforme con la Norma ISO 9001:2015

para las actividades: A) La producción de tuberías de polietileno entre 20 mm. y 1000 mm. de diámetro. La producción de Push-Fast y accesorios manipulados para tuberías de polietileno. La comercialización de tubos, accesorios para tubería y valvulería. B) Comercialización y posventa de máquinas electrosoldables y de herramientas relacionados con la electrofusión.

que se realizan en: A) PZ ZUDIBIARTE, S/N - PABELLONES A y C. 01409 - OKONDO (ARABA/ALAVA) B) ANABEL SEGURA 11, EDIFICIO A 1º s. 28108 - MADRID C) CL SALAS BARBADILLO, 12 LOCAL E. 28017 - MADRID

Fecha de primera emisión: 1996-06-24
Fecha de última emisión: 2018-12-30
Fecha de modificación: 2020-07-09
Fecha de expiración: 2021-12-30

Rafael GARCÍA MEIRO
Director General

AENOR INTERNACIONAL S.A.U.
Gervasa, 6, 28020 Madrid, España
Tel: 91 424 6200 - www.aenor.com



THE INTERNATIONAL CERTIFICATION NETWORK

CERTIFICATE

AENOR has issued an IQNet recognized certificate that the organization:

ALIXIS IBERIA, S.A.U.

A) PZ ZUDIBIARTE, S/N - PABELLONES A y C. 01409 - OKONDO (ARABA/ALAVA) B) ANABEL SEGURA 11, EDIFICIO A 1º s. 28108 - MADRID C) CL SALAS BARBADILLO, 12 LOCAL E. 28017 - MADRID

has implemented and maintains a

Quality Management System

for the following scope:

A) Production of polyethylene pipes diameters from 20 mm. up to 1000 mm. Production of Push-Fast and fabricated fittings for PE pipes. B) Trading and after sales service of electrofusion machines and other electrofusion related toolings.

which fulfills the requirements of the following standard

ISO 9001:2015

First issued on: 1999-08-01 Last issued: 2020-07-09 Validity date: 2021-12-10

This attestation is directly linked to the IQNet Partner's original certificate and shall not be used as a stand-alone document

Registration Number: ES-0288/1996



Alex Stoichiton
President of IQNet

Rafael GARCÍA MEIRO
Chief Executive Officer

AENOR

Original document Certificate

IQNet Partners*
AENOR Spain AFNOR Certification France AFCEP Portugal CCC Cignus CSIQ Italy CQC China CQM China CQR Czech Republic Cio Cert Croatia DQS Holding GmbH Germany EAGLE Certification Group USA FCMF Brazil FIMCOBOL Mexico IAF ENAC Colombia Inspecta Scandinavia SRI Poland INCTEC Costa Rica IRAM Argentina IQA Japan KPCF Korea MBRTCC Greece MSZT Hungary Nemko AS Norway NSAI Ireland NYCE-SISE Mexico PCBC Poland Quality Austria Austria SR Suisa SII Israel SIQ Slovenia SIRM QAS International Malaysia SIQS Switzerland SIVAC Romania TEST St Petersburg Russia TSE Turkey YUQS Serbia

* The list of IQNet partners is valid at the time of issue of this certificate. Updated information is available under www.iqnet-certification.com

AENOR

Certificado del Sistema de Gestión Ambiental



GA-2005/0349

AENOR certifica que la organización

ALIXIS IBERIA, S.A.U.

dispone de un sistema de gestión ambiental conforme con la Norma ISO 14001:2015

para las actividades: La producción de tuberías de polietileno entre 20 mm. y 1000 mm. de diámetro. La producción de Push-Fast y accesorios manipulados para tuberías de polietileno. La comercialización de tubos, accesorios para tubería y valvulería.

que se realizan en: PZ ZUDIBIARTE, S/N - PABELLONES A y C. 01409 - OKONDO (ARABA/ALAVA)

Fecha de primera emisión: 2005-08-02
Fecha de última emisión: 2020-08-02
Fecha de expiración: 2023-08-02

Rafael GARCÍA MEIRO
Director General

AENOR INTERNACIONAL S.A.U.
Gervasa, 6, 28020 Madrid, España
Tel: 91 424 6200 - www.aenor.com



THE INTERNATIONAL CERTIFICATION NETWORK

CERTIFICATE

AENOR has issued an IQNet recognized certificate that the organization:

ALIXIS IBERIA, S.A.U.

PZ ZUDIBIARTE, S/N - PABELLONES A y C. 01409 - OKONDO (ARABA/ALAVA)

has implemented and maintains a

Environmental Management System

for the following scope:

Production of polyethylene pipes diameters from 20 mm. up to 1000 mm. Production of Push-Fast and fabricated fittings for PE pipes. B) Trading and after sales service of electrofusion machines and other electrofusion related toolings.

which fulfills the requirements of the following standard

ISO 14001:2015

First issued on: 2005-08-02 Last issued: 2020-08-02 Validity date: 2023-08-02

This attestation is directly linked to the IQNet Partner's original certificate and shall not be used as a stand-alone document

Registration Number: ES-2005/0349



Alex Stoichiton
President of IQNet

Rafael GARCÍA MEIRO
Chief Executive Officer

AENOR

Original document Certificate

IQNet Partners*
AENOR Spain AFNOR Certification France AFCEP Portugal CCC Cignus CSIQ Italy CQC China CQM China CQR Czech Republic Cio Cert Croatia DQS Holding GmbH Germany EAGLE Certification Group USA FCMF Brazil FIMCOBOL Mexico IAF ENAC Colombia Inspecta Scandinavia SRI Poland INCTEC Costa Rica IRAM Argentina IQA Japan KPCF Korea MBRTCC Greece MSZT Hungary Nemko AS Norway NSAI Ireland NYCE-SISE Mexico PCBC Poland Quality Austria Austria SR Suisa SII Israel SIQ Slovenia SIRM QAS International Malaysia SIQS Switzerland SIVAC Romania TEST St Petersburg Russia TSE Turkey YUQS Serbia

* The list of IQNet partners is valid at the time of issue of this certificate. Updated information is available under www.iqnet-certification.com

NOTA: Los datos facilitados en este catálogo, como consecuencia de la constante mejora y evolución de nuestros productos, pueden variar sin previo aviso.

Este catálogo no tiene carácter contractual, y toda la información se da de buena fe.

Declinamos cualquier responsabilidad derivada de la aplicación de los mismos.

La versión más actualizada de este catálogo la encontrará disponible en nuestra página web.

Normas Generales

PRECIOS: Los precios son de VENTA AL PÚBLICO (Recomendados) y pueden ser modificados sin previo aviso.

Los precios no incluyen IVA.

EXPEDICIONES Y PEDIDOS: La mercancía viaja siempre por cuenta y riesgo del comprador.

Los pedidos serán siempre de cajas o camiones completos, en función de la naturaleza del producto y acuerdos comerciales.

Las unidades mínimas de venta recogidas en la presente tarifa son de obligado cumplimiento, así como la venta por múltiplos de esta, conforme a los acuerdos comerciales en vigor.

JIMTEN, S.A./ALIXIS IBERIA no gestionará ningún envío a direcciones distintas al domicilio habitual del comprador.

ANULACIONES DE PEDIDOS: No se admiten anulaciones de pedidos que ya están fabricados o en curso de fabricación.

DEVOLUCIONES DE MATERIAL: No se admiten devoluciones de material, salvo por defecto imputable a la fabricación o a la gestión del transporte, en cuyo último caso el comprador deberá inspeccionar las mercancías de forma inmediata tras su recepción. Cualquier defecto reconocible en el transcurso de la inspección rutinaria y que sea asumible al transporte, deberá notificarse a JIMTEN, S.A./ALIXIS IBERIA por escrito en un plazo máximo de veinticuatro horas tras su recepción, no pudiendo ser atendidas las reclamaciones que excedan ese período.

CONDICIONES DE ENTREGA: Los pedidos podrán ser suministrados y facturados en parte sin que ello suponga la anulación de los mismos.

CALIDAD Y GARANTÍA: La garantía de nuestros materiales queda limitada a la reposición del producto, modelo o pieza que sea reconocida como defectuosa.

Igualmente cubre todos los daños a terceros mediante póliza de responsabilidad civil, siempre y cuando se hayan observado las especificaciones y prescripciones para su uso correcto e instalación descritas en la documentación técnica del producto.

Dado las características de los materiales cualquier reclamación de calidad, deberá plantearse dentro de los 15 días naturales siguientes a la entrega del material. Cualquier utilización o uso de nuestros materiales para fines distintos a los que fueron fabricados eximirá de cualquier tipo de responsabilidad.

PAGOS: Los precios de la Tarifa están considerados para pagos al contado. No obstante, previa clasificación del Comprador, se podrá optar a otras condiciones de mercado en el marco de las normas vigentes, entre ellas la Ley 15/2010 de medidas contra la morosidad en las operaciones comerciales.

Las letras de cambio, pagares o cheques tan solo se consideran aceptados por JIMTEN S.A./ALIXIS IBERIA en el momento en el que se hagan efectivos, no constituyendo en ningún caso la entrega de los mismos el cumplimiento de la obligación correspondiente.

Anexo 1: En caso de que la mora, la insolvencia o las deudas por parte del comprador hagan peligrar la solvencia de éste, JIMTEN, S.A./ALIXIS IBERIA estará facultada para exigir de forma inmediata la liquidación de todas las cantidades adeudadas o la provisión de garantías, tanto en ese momento como en futuros.

JIMTEN, S.A./ALIXIS IBERIA podrá realizar únicamente las entregas pendientes en caso de que éstas se hayan abonado por adelantado o se hayan presentado las garantías suficientes. En caso de que el comprador no pueda cumplir lo anterior en un período razonable de tiempo, JIMTEN, S.A./ALIXIS IBERIA podrá rescindir el contrato de venta.

RESERVA DE PROPIEDAD: JIMTEN, S.A./ALIXIS IBERIA conservará la propiedad de las mercancías suministradas hasta que se abone el pago total del correspondiente precio de compra y se liquiden la totalidad de las deudas pendientes por parte del comprador a JIMTEN, S.A./ALIXIS IBERIA.

En los casos especificados en el Anexo 1, JIMTEN, S.A./ALIXIS IBERIA también podrá impedir la tramitación y la reventa de la mercancía entregada con efectos inmediatos. Una declaración de rescisión del contrato por parte de JIMTEN, S.A./ALIXIS IBERIA también se considerará una anulación de la autorización para revender y cobrar los derechos de reventa. En estos, caso JIMTEN, S.A./ALIXIS IBERIA también podrá exigir la devolución inmediata de las mercancías entregadas por cuenta del comprador.

PROHIBICIÓN DE CESIÓN: El comprador tan solo podrá ceder los derechos y las deudas dimanantes de contratos de venta a terceros con el consentimiento previo de JIMTEN, S.A./ALIXIS IBERIA.

RESERVA: Nos reservamos el derecho a introducir modificaciones de diseño, medidas y unidades de embalaje en nuestros fabricados sin previo aviso.

COMPETENCIA JUDICIAL: Para resolver las cuestiones que puedan derivarse de la aplicación de estas Normas, tanto JIMTEN, S.A./ALIXIS IBERIA como comprador, conviene someterse a los Juzgados y Tribunales pertinentes, renunciando a su propio fuero si fuese otro.

LIMITACIONES: Queda prohibida la reproducción total o parcial de esta tarifa sin la autorización expresa de JIMTEN, S.A./ALIXIS IBERIA.

Esta tarifa está sujeta a modificación sin previo aviso, todos los datos y especificaciones técnicas expresadas, se dan de buena fe y no tienen carácter contractual. Declinamos cualquier responsabilidad derivada de la aplicación de los mismos.

Condições Gerais

PREÇOS: Os preços são de venda ao público (recomendados) e podem ser alterados sem aviso prévio.

Os preços não incluem IVA.

EXPEDIÇÕES E PEDIDOS: A mercadoria viaja sempre por conta e risco do comprador.

Os pedidos serão sempre de caixas completas ou caminhões completos, dependendo da natureza do produto e dos acordos comerciais.

As unidades mínimas de venda recolhidas na presente tabela são de obrigado cumprimento, bem como a venda de múltiplos destas, em conformidade com os acordos comerciais em vigor.

JIMTEN, S.A./ALIXIS IBERIA não gestionará nenhum envio a endereços distintos ao domicílio habitual do comprador.

ANULAÇÃO DE PEDIDOS: Não se aceitam anulações de pedidos que já estão fabricados ou em curso de fabricação.

DEVOLUÇÃO DE MATERIAL: Não se aceitam devoluções de material, salvo no caso de defeito imputável à produção o à gestão do transporte, caso em que o comprador deve inspeccionar as mercadorias imediatamente após a sua recepção. Qualquer dano encontrado no momento da inspeção rotinária, que é imputável ao transporte, deverão ser comunicada por escrito a JIMTEN, S.A./ALIXIS IBERIA num prazo não superior a vinte e quatro horas após o recebimento, não podendo ser atendidas as reclamações que excedam a esse período.

CONDIÇÕES DE ENTREGA: Os pedidos poderão ser fornecidos em parte sem que se suponha a anulação dos mesmos.

QUALIDADE E GARANTIA: A garantia dos nossos materiais fica limitada à reposição do produto, modelo ou peça que seja reconhecida como defeituosa.

Cobre igualmente todos os danos a terceiros mediante apólice de responsabilidade civil, sempre e quando se tenham observado as especificações e prescrições para seu uso correcto e instalação descritas na documentação técnica do produto.

Dadas as características dos materiais, qualquer reclamação da qualidade, deverão apresentar-se dentro dos 15 dias naturais seguintes na entrega do material. Qualquer utilização dos nossos materiais para fins distintos para o que foram fabricados isentará de qualquer tipo de responsabilidade.

PAGAMENTOS: Os preços da Tabela estão considerados para pagamentos ao contado. Não obstante, prévia classificação do Comprador, se poderá optar a outras condições do mercado no limite das normas vigentes, entre as quais encontra-se a Ley 15/2010 de medidas contra a morosidade nas operações comerciais.

Letras de câmbio, pagamentos ou cheques são considerados aceites apenas por JIMTEN S.A./ALIXIS IBERIA no momento em que se tornarem efectivos, não constituindo em caso algum a entrega dos mesmos o cumprimento da obrigação correspondente.

Anexo 1: Em caso a mora, a insolvência e as dívidas pela parte do comprador façam perigar a solvabilidade deste, JIMTEN S.A./ ALIXIS IBERIA exija de forma imediata a liquidação de todas as quantidades adequadas o a provisão de garantias, tanto nese momento quanto em momentos futuros. JIMTEN S.A./ ALIXIS IBERIA poderá realizar unicamente as entregas pendentes no caso destas foram pagadas previamente o foram sido ofecidas as garantias suficientes. Em caso o comprador não pudera cumprir o anterior num período razoável de tempo, JIMTEN S.A./ALIXIS IBERIA poderá rescindir o contrato de venda.

RESERVA DE PROPIEDADE: JIMTEN, S.A./ALIXIS IBERIA conservará a propriedade das mercadorias subministradas até o pagamento total do correspondente preço de compra e se pague a totalidade das dívidas pendentes pela parte do comprador a JIMTEN, S.A./ALIXIS IBERIA Nos casos especificados no anexo 1, JIMTEN, S.A./ALIXIS IBERIA também poderá impedir a tramitação e a reventa da mercadoria entregada com efeitos imediatos. Uma declaração de rescisão do contrato pela parte de JIMTEN, S.A./ALIXIS IBERIA também será considerado uma anulação da autorização para revender e cobrar os direitos da reventa.

Em tal caso JIMTEN, S.A./ALIXIS IBERIA pode também exigir a imediata devolução das merdadorias fornecidos pelo comprador.

PROIBIÇÃO DA CESSÃO: O comprador só poderá ceder os direitos e as dívidas emergentes de contratos de venda a terceiros com o consentimento prévio de JIMTEN, S.A./ALIXIS IBERIA.

RESERVA: Reservamo-nos o direito de introduzir modificações de desenho, medidas e unidades de embalagem nos nossos artigos sem aviso prévio.

COMPETÊNCIA JUDICIAL: Para resolver as questões derivadas da aplicação destas Normas, tanto JIMTEN, S.A./ALIXIS IBERIA como o comprador, devem submeterse aos tribunais de Alicante, renunciando ao seu próprio foro ser for outro.

LIMITAÇÕES: Fica proibida a reprodução total ou parcial desde catálogo sem a autorização expressa de JIMTEN, S.A./ALIXIS IBERIA.

Este catálogo, está sujeito a modificações sem aviso prévio e não tem carácter contractual, todos os dados são fornecidos de boa fé. Declinamos qualquer responsabilidade proveniente de aplicação dos mesmos.

Aliaxis Iberia, S.A.U.

P.I. Zudibiarte, s/n
01409 Okondo-Álava, España
T +34 945 898 200
F +34 945 898 126
masa@masa.es



alixis.es

Empresa registrada según normas



ER-0288/1996

GA-2005/0349

