

40 YEARS
TOGETHER

GENEBRE

2021

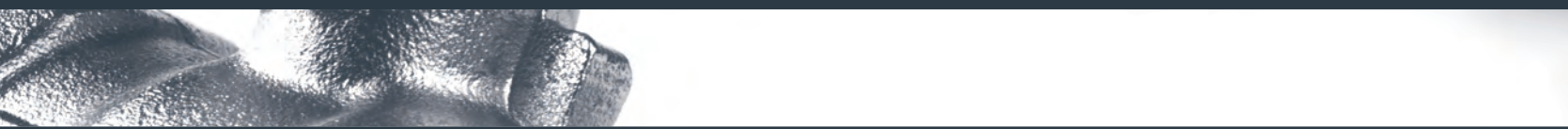

LÍNEA HIDROSANITARIA
HYDROSANITARY LINE

GENEBRE



20**21**

LÍNEA HIDROSANITARIA
HYDROSANITARY LINE

 **YEARS**
TOGETHER

El poder del agua

El agua es un bien fundamental para la vida y el planeta, pero también un recurso escaso y limitado. Estamos acostumbrados a verla correr, la usamos diariamente para todo y, hasta hace poco, se creía inagotable. Sin embargo, hoy sabemos que no es así y que para su conservación en el futuro se necesita una actitud responsable diaria y una mayor conciencia ambiental de cada uno de nosotros.

Este ha sido el punto de partida del Grupo Genebre desde sus orígenes. Personas concienciadas que aplicamos esta filosofía en todos y cada uno de nuestros procesos y productos. Porque podemos soñar en un futuro más sostenible, pero para que este sueño se haga realidad debemos empezar desde nuestras propias acciones.



The power of water

Water is an essential resource for life and for the planet. At the same time, water is also scarce and limited. In our minds, water is always running, and until recently, it was thought to be in endless supply. However, today we know that this is not the case. In order to save water in the future, we need to have a responsible attitude every day, as well as a greater environmental awareness.

This has been the Genebre Group's philosophy since the beginning. Genebre is made up of conscious individuals who apply this philosophy to each and every one of our processes and products. We can dream about a more sustainable future, but in order to make this dream a reality, we have to start today, with our individual actions.

Liderazgo

Empresa líder en válvulas y accesorios para el control de fluidos

Genebre es una empresa líder y un referente mundial en la fabricación de válvulas y accesorios para el control de fluidos y grifería de alta calidad. Controlamos todos los procesos de creación, dando respuesta a las necesidades particulares de cada mercado: desde el concepto inicial y el diseño del producto, a la producción y la comercialización. Desde su fundación en 1981 hasta nuestros días, combinamos una gran capacidad de innovación y una clara apuesta por el mercado global.

Valor diferencial

Nuestro valor diferencial se debe a nuestra manera diferente de actuación: I+D+i, técnicas avanzadas de fabricación, disponibilidad de stock, precios competitivos, un servicio al cliente muy cuidado y, sobre todo, responsabilidad medioambiental.

Leadership

Leading company in valves and accessories for fluid control

Genebre is a leading company and world reference in fluid control and high quality taps. We control all of the creation processes, responding to the specific needs of each market: from the initial concept and design of the product to the production and commercialization. Since its founding in 1981, we have combined important innovation skills with a strong commitment to the international market.

Differential value

Our differential value is due to our different approach: R+D+I, advanced production techniques, stock availability, competitive prices, specialized customer service, and above all, environmental awareness.



Experiencia



GENEBRE TIENE IMPLANTADO UN SISTEMA DE GESTIÓN DE LA CALIDAD PARA EL DISEÑO, PRODUCCIÓN Y DISTRIBUCIÓN DE VÁLVULAS PARA EL CONTROL Y LA REGULACIÓN DE FLUIDOS, GRIFERÍA Y OTROS PRODUCTOS PARA EL USO COLECTIVO.

- Este sistema está certificado de acuerdo a la última versión de la norma UNE-EN-ISO 9001, por parte del prestigioso organismo certificador alemán TÜV Rheinland y revisado anualmente.
- Modelo Europeo de Excelencia Empresarial (EFQM) European Foundation for Quality Management.
- ISO 14001, certificación para el Sistema de Gestión Ambiental. Este sistema está certificado siguiendo la última versión de la norma UNE-EN-ISO 14001, por parte del prestigioso organismo certificador alemán TÜV Rheinland.
- UNE 166.002:2006, sistema de gestión de la I+D+i.
- Marcado CE para las válvulas industriales de acuerdo a la Directiva de Equipos a Presión 2014/68/UE con certificación externa otorgada por TÜV Rheinland.
- Homologación y Marcado N de Aenor para la línea de válvulas de gas.
- Certificados de agua potable, confirmando el cumplimiento de los criterios sanitarios de la calidad del agua para el consumo humano RD 140/2003 de 07 de febrero (legislación española) y de la directiva europea 98/83/CE del Consejo Europeo del 03 de noviembre de 1998, relativa a la calidad de las aguas destinadas al consumo humano por el Laboratorio Oliver Rodes.
- Homologación CE y otras específicas para mercados como Bielorrusia, Chile, Polonia, Rusia, Ucrania, Singapur y Arabia Saudí.

Experience

GENEBRE HAS IMPLEMENTED A QUALITY MANAGEMENT SYSTEM TO CONTROL THE DESIGNING, MANUFACTURING AND DISTRIBUTION OF VALVES FOR THE CONTROL AND REGULATION OF FLUIDS, TAPS AND OTHER PRODUCTS FOR COLLECTIVE USE.

- This system complies with the requirements of the latest version of the current international UNE-EN-ISO 9001, certified by the prestigious German certification organization TÜV Rheinland and reviewed annually.
- European Foundation for Quality Management (EFQM).
- ISO 14001, certification for the Environmental Management System. This system is certified according to the latest version of the international UNE-EN-ISO 14001, and also by TÜV Rheinland.
- UNE 166.002:2006, R+D+I Management System.
- CE stamp for industrial valves according to the Pressure Equipment Directive 2014/68/EU with external certification by TÜV Rheinland.
- N Aenor stamp for the gas valves line.
- Water quality certification, confirming compliance with the health criteria of water quality for human consumption (RD 140/2003 7 February - Spanish legislation), and the European Directive 98/83/EC of the European Council, 3 November 1998, relating to the water quality intended for human consumption by "Laboratorios Oliver Rodes".
- EC homologation and other specific certifications for markets in Belarus, Chile, Poland, Russia, Ukraine Singapore and Saudi Arabia.



Contacta con nosotros | Contact with us

Cerca de ti

Close to you



Tenemos 7 oficinas propias en 3 continentes diferentes.

Contamos con representación comercial en 22 países.

Llegamos a más de 110 países.

We have 7 offices on 3 continents.

We count on sales representatives in 22 countries.

We reach more than 110 countries.



Estés donde estés, estamos cerca de ti, porque nuestro ámbito de actuación es el mundo.

Wherever you are, we are close to you, because our field of action is the world.

ESPAÑA / SPAIN

hidrosanitaria@genebre.es

www.genebre.es

Tel: 93 298 80 01

Fax: 93 298 80 06

—

INTERNACIONAL / INTERNATIONAL

exportacion@genebre.es

www.genebre.com

Europa / Europe: +34 93 298 80 15

Europa este / Eastern Europe:

+34 93 298 80 19

América Latina / Latin America:

+34 93 298 80 17

América del Norte / North America:

+34 93 298 80 17

Fax: +34 93 298 80 08

—

HORARIO COMERCIAL /

COMMERCIAL TIMETABLE:

8.30 h. - 13.30 h. / 15.00 h. - 18.00 h.

Viernes / Friday 8:00 h. - 16:00 H.

—

CORREO / MAILING ADDRESS

Edificio Genebre

Av. Joan Carles I, 46-48

Distrito económico de L'Hospitalet

L'Hospitalet de Llobregat 08908

Barcelona (Spain)

—

OTROS TELÉFONOS / OTHER GENERAL TELEPHONE NUMBERS

Tel. Centralita / Central telephone number:

+34 93 298 80 00

Administración / Administration:

+34 93 298 80 02

Fax: +34 93 298 80 07

Servicio de Atención Técnica al Cliente /

Technical Support telephone number:

+34 902 504 203

—

Genebre Argentina: www.genebre.com.ar

Genebre do Brasil: www.genebre.com.br

También nos encontrarás en /

You will also find us on:



Offices

Barcelona (Spain) / São Paulo (Brazil) / Buenos

Aires (Argentina) / Mexico City (Mexico) /

Ningbo (China) / Florida (Uruguay) /

Hong Kong (China)

La fuerte apuesta por la internacionalización, la diversificación y la innovación son las claves de nuestro crecimiento.

Strong commitment to internationalization, diversification and innovation are key to our growth.

Index



01

01 VÁLVULAS VALVES

Válvulas de esfera / Ball valves p. 17-23
Válvulas esfera Mini / Mini ball valves p. 23-25
Válvulas de empotrar / Built-in valves p. 27-30
Válvulas para manguera / Bibcock valves p. 31-36
Válvulas para barril / Barrel valves p. 36
Válvulas escuadra / Angle valves p. 37-41
Válvulas de retención / Check valves p. 42-45
Válvulas de compuerta / Gate valves p. 46-49
Filtros / Filters p. 49-52
Válvulas reductoras de presión /
Pressure reducer valves p. 53-56
Colectores / Collectors p. 57
Presostatos / Pressure Switch p. 58
Controladores / Controllers p. 59-61
Manómetros / Pressure gauges p. 62-66
Válvulas antifraude / Anti fraud valves p. 67-70

02

02 CLIMATIZACIÓN CLIMATE CONTROL

Válvulas de calefacción / Heating valves p. 74-82
Cabezales térmicos / Thermal heads p. 83
Válvulas Monotubo / Single-pipe valves p. 83-84
Racores y colectores / Fitting and manifolds p. 84-86
Válvulas de seguridad / Safety valves p. 87-88
Purgadores / Air vents p. 88-90
Filtros para caldera / Filters for condensing boilers p. 90-91
Suelo radiante / Underfloor heating p. 92-94
Válvulas de equilibrado / Balancing valves p. 95-98
Válvulas motorizadas / Motorised valves p. 98-99
Termostatos / Thermostats p. 100-102
Bombas de condensación / Condensate pumps p. 103
Energía solar / Solar energy p. 104-107

03

03 VÁLVULAS DE GAS GAS VALVES

Válvulas rectas / Straight valves p. 110-111
Válvulas escuadra / Square valves p. 112-113
Válvulas rectas cromadas / Chrome-plated straight valves p. 114-115
Válvulas escuadra cromadas / Chrome-plated angle valves p. 115-116



04

04 ELECTROVÁLVULAS SOLENOID VALVES

Electroválvulas 2/3 vías / 2/3 way solenoid valves p. 120-134
Electroválvulas para gas / Gas solenoid valves p. 134-135
Válvulas hidráulicas / Hydraulic valves p. 135-136
Bobinas y conectores / Coils and connectors p. 136-138

05 ACCESORIOS DE LATÓN BRASS ACCESSORIES

Accesorios Rac-Ge /
Rac-Ge accessories p. 142-148
Otros accesorios de latón /
Other brass accessories p. 149-154



05

06 CONTADORES WATER METERS

Contadores a rosca /
Threaded water meters p. 158-160
Contadores a brida /
Flanged water meters p. 160-161
Contador de calorías /
Thermic energy meters p. 161
Accesorios / Accessories p. 162



06

CONDICIONES GENERALES DE VENTA GENERAL SALES CONDITIONS

p. 164

Índice por artículo

Article index

Nº Artículo Article No.	Nº Página Page No.	Nº Artículo Article No.	Nº Página Page No.	Nº Artículo Article No.	Nº Página Page No.	Nº Artículo Article No.	Nº Página Page No.
0010	150	2848	60	3063	33	3122PN	43
0012	143	2850	60	3064	34	3123	43
0015	150	2918	36	3065	35	3124	44
0017	143	2919	36	3066	34	3124	148
0020	151	3017N	19	3066B	34	3131	44
0022	144	3019N	19	3068	36	3134	105
0022R	144	3020	17	3069	49	3136	105
0025	151	3020N	17	3070	23	3140	44
0030	151	3021	17	3073	98	3142	43
0030	152	3022	18	3074	95	3145	45
0032	144	3023	17	3075	21	3145N	45
0032	145	3023N	17	3080	23	3160	45
0035	152	3028	18	3081	25	3160N	45
0037	145	3029	18	3082	26	3178	105
0040	152	3029H	18	3083	28	3179	87
0042	145	3030I	19	3084	22	3180	45
0042	146	3031	19	3085	22	3180N	45
0045	153	3032	20	3088	22	3182	87
0047	146	3033	20	3088	147	3183	28
0048	154	3034	20	3089	23	3183B	28
0049	147	3034H	20	3089	147	3184	29
0050	153	3034I	20	3090	41	3184B	29
0052	146	3035	21	3091	41	3185	45
0052	147	3036	21	3092	41	3185N	45
0055	148	3037	21	3094	38	3186	47
0055	154	3038	21	3094E	38	3187	47
0056	154	3044	25	3094P	38	3188	87
0057	154	3044	89	3095	40	3189	87
0058	154	3046	21	3095N	40	3190	46
0061	148	3048	22	3096	23	3190N	46
0062	148	3051	25	3096H	23	3191	87
0063	148	3056	28	3097	24	3191E	87
1431S	106	3059	32	3097H	24	3192	87
1431U	106	3059D	32	3104	39	3192E	87
1444	107	3059L	32	3106	39	3193	48
1451	107	3059R	32	3109	39	3194	48
1452	107	3060	33	3120	44	3195N	40
2228	95	3060F	33	3121	43	3196N	40
2272	56	3061	33	3121N	43	3211	35
2444	106	3062	39	3122P	43	3215	36

Nº Artículo Article No.	Nº Página Page No.	Nº Artículo Article No.	Nº Página Page No.	Nº Artículo Article No.	Nº Página Page No.	Nº Artículo Article No.	Nº Página Page No.
3217	35	3342	56	3691	113	3887	60
3220	46	3344	56	3692	113	3910I	56
3221	46	3367	34	3714	65	3911	101
3221N	46	3392	41	3772	57	3912	101
3222	46	3396	24	3773	57	3915	102
3227	47	3397	24	3775	57	3916	102
3228	47	3430	68	3777	57	3917	101
3229	48	3430A	68	3780	58	3930	100
3230	46	3430N	68	3781	58	3930K	100
3234	26	3434	69	3784	58	3931	83
3235	26	3438	69	3785	58	3931	101
3236	48	3446	69	3788	57	3931K	100
3250	61	3450	69	3789	57	3932	100
3253	61	3451	24	3802	62	3950	66
3254	61	3454	70	3809	62	3952	66
3262	103	3462	70	3814	65	3955	66
3263	103	3499	70	3818	63	3956	66
3264	61	3500	114	3819	62	4010	131
3272E	23	3505	114	3820	63	4020	128
3282E	23	3510	114	3820N	63	4021	130
3294	38	3515	114	3821	63	4022	128
3302	50	3520	115	3822	64	4030	121
3302N	50	3525	115	3822N	64	4030Q	121
3304	50	3550	115	3824	66	4031	121
3310	50	3555	115	3824N	66	4032	121
3311	50	3560	115	3825	64	4040	124
3312	51	3565	116	3826	64	4041	124
3312	116	3570	116	3827	65	4050	128
3313	51	3575	116	3829	65	4100	131
3314	51	3600	113	3840	62	4112	134
3316	52	3610	111	3850	49	4115	134
3316E	52	3615	111	3860	49	4118	134
3317	52	3620	111	3865	49	4120	135
3318	54	3622	111	3880	59	4122	135
3318N	54	3625	112	3881	59	4210	122
3320	54	3627	112	3882	59	4220	122
3320E	54	3630	112	3883	59	4221	122
3324	55	3632	112	3884	59	4222	123
3324R	55	3640	113	3884	60	4223RC	123
3340	55	3690	113	3886	60	4232	123

Índice por artículo

Article index

Nº Artículo Article No.	Nº Página Page No.	Nº Artículo Article No.	Nº Página Page No.	Nº Artículo Article No.	Nº Página Page No.	Nº Artículo Article No.	Nº Página Page No.
4240	125	4828	137	70152	77	72319	91
4250	124	4974	137	70153	76	72501	83
4320	126	6029	159	70153	77	72606	94
4321	126	6029P	160	70153	78	72961	97
4322	126	6038	162	70154	76	73070	90
4324	126	6040	162	70154	77	73153	88
4328	126	6041	162	70154	78	73189	83
4330	127	6045	162	70171	86	73189	94
4332	127	6060	160	70176	87	73262	103
4333	129	6060A	161	70177	84	73286	91
4335	127	6066	161	70224	85	73541	91
4336	127	6085	161	70224	93	73566	98
4340	125	6090	160	70246	93	73601	91
4425	129	6100	159	70302	25	73717A	96
4425N	129	6110C	159	70302	89	73717M	96
4426	130	6111C	159	70304	25	75404	84
4440	124	6115C	159	70304	90	78454	97
4519	131	6120C	159	70306	83	79001	82
4630	132	6121C	159	70306	93	79002	82
4631	132	70017	88	70500	103	79320	98
4632	133	70018	88	70564	79	8045	102
4633	133	70024	86	70564	80	8046	102
4635	134	70031	78	70564	81	8047	102
4720	135	70032	78	70565	79	8048	102
4721	135	70035	86	70565	80	K3000	26
4730	136	70037	88	70565	81	K3046B	93
4731	136	70037	89	70585	83	K3046R	93
4790	98	70037	105	70587	79	K3052P	29
4791	99	70038	89	70587	80	K3053	29
4792	99	70041	85	70588	79	K3054	30
4793	99	70042	85	70588	80	K3770	90
4795	99	70048	81	70590	82	K3771	90
4801 05	138	70049	81	70621	97	K4000	138
4801 08	138	70069	86	70735	85	M3054	30
4803	138	70070	85	70874	96	M3055	30
4804	138	70071	85	71012	88	M3057	30
4805	136	70139	85	71028	84	R360	35
4808	137	70151	76	71410	92	T2228	97
4814	137	70151	77	71411	92	T3074	97
4819	137	70152	76	72190	94		



GENEBRE



01

VÁLVULAS VALVES



Una gama completa de válvulas de latón, esfera manguera, retención, compuerta, filtros, manómetros, ... para todo tipo de instalaciones.

A complete range of brass ball valves, bibcock ball valves, retention valves, gate valves, strainers, pressure gauges, ... for all types of installations.

VÁLVULAS DE ESFERA / BALL VALVES

ELEMENTOS / ELEMENTS

1. Cuerpo / Body
2. Tapa / Cap
3. Esfera / Ball
4. Eje + Juntas tóricas / Stem + O'rings
5. Asientos / Ball seats
6. Tuerca / Nut
7. Accionamiento / Handle



CARACTERÍSTICAS DE LAS VÁLVULAS

- Válvulas esfera para uso ON/OFF, abierto - cerrado
- Construidas en latón UNE-EN 12165, resistente a la corrosión
- Acabado cromado, niquelado o en color latón
- Conexiones roscadas Macho - Hembra G ISO 228/1 y NPT, tubería PE, extremos soldar
- Disponibles en PN16, PN25 y PN40
- Disponibles en diferentes dimensiones y pasos (total, estándar o reducido)
- Disponibles diferentes accionamientos (palanca, palomilla, cuadradillo, etc)

VALVES CHARACTERISTICS

- Ball valves for ON/OFF use, open - closed
- Construction in EN 12165 brass, corrosion resistant
- Chrome plated, nickel plated or brass colour finished
- Threaded ends Male - Female G ISO 228/1 and NPT, PE pipe, welding ends
- Available in PN16, PN25 and PN40
- Available different dimensions and bores (Full, estándar and reduced)
- Available different controls (Manual lever, Aluminum butterfly handle, square handle, etc)

Ref. 3020 - 3020N

NEW



Válvula de esfera serie pesada.

PN 40. Paso total. Construcción en latón UNE-EN 12165 cromado. Asientos PTFE. Extremos rosca gas (BSP) H-H - ISO 228/1. Temp. máx. 110°C. Mando manual por palanca de acero.

También disponible con rosca NPT (3020N)

Heavy ball valve.

PN 40. Full bore. Body chrome plated brass UNE-EN 12165. PTFE seats. Gas threaded ends (BSP) F-F - ISO 228/1. Max. Temp. 110°C. Steel lever manual control.

Also available NPT thread (3020N).

R	P	A	L	M
1/4"	10	45	48	84
3/8"	10	45	50	84
1/2"	15	47	58	84
3/4"	20	58	65	98
1"	25	61	78	98
1 1/4"	32	74	88	126
1 1/2"	40	80	105	126
2"	50	91	122	158
2 1/2"	59	96	140	158
3"	72	118	163	195
4"	90	133	261	261

CÓDIGO CODE	MEDIDA SIZE	PESO WEIGHT	CAJA / BOX CARTON	P.V.P. € PRICE €
3020 02	1/4"	0,130	8-192	5,05
3020 03	3/8"	0,120	8-192	5,05
3020 04	1/2"	0,174	8-144	6,05
3020 05	3/4"	0,288	8-96	8,86
3020 06	1"	0,432	6-72	14,11
3020 07	1 1/4"	0,706	4-48	21,69
3020 08	1 1/2"	0,983	2-24	30,11
3020 09	2"	1,508	2-18	46,83
*3020 10	2 1/2"	2,430	4-8	84,97
*3020 11	3"	4,035	2-4	136,58
*3020 12	4"	6,330	1-2	208,85

Precios rosca NPT a consultar. / NPT thread prices on request.
*Nuevas medidas / New sizes.

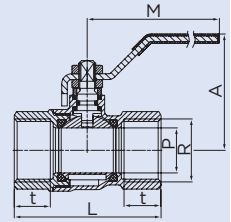

Ref. 3021

NEW



Válvula de esfera serie pesada. Palanca de acero inoxidable.

PN 40. Paso total. Construcción en latón UNE-EN 12165 cromado. Asientos PTFE. Extremos rosca gas (BSP) H-H - ISO 228/1. Temp. máx. 110°C. Mando manual por palanca de acero inoxidable AISI 304.

Heavy ball valve. Stainless steel lever manual control.

PN 40. Full bore. Body chrome plated brass UNE-EN 12165. PTFE seats. Gas threaded ends (BSP) F-F - ISO 228/1. Max. Temp. 110°C. AISI 304 stainless steel lever manual control.

R	P	A	L	M
1/4"	10	45	48	84
3/8"	10	45	50	84
1/2"	15	47	58	84
3/4"	20	58	65	98
1"	25	61	78	98
1 1/4"	32	74	88	126
1 1/2"	40	80	105	126
2"	50	91	122	158
2 1/2"	59	96	140	158
3"	72	118	163	195
4"	90	133	261	261

3021 02	1/4"	0,130	8-192	6,05
3021 03	3/8"	0,129	8-192	6,05
3021 04	1/2"	0,178	8-144	7,04
3021 05	3/4"	0,285	8-96	10,65
3021 06	1"	0,387	6-72	15,69
3021 07	1 1/4"	0,688	4-48	25,28
3021 08	1 1/2"	0,958	2-24	34,24
3021 09	2"	1,575	2-18	52,66
*3021 10	2 1/2"	2,480	4-8	93,47
*3021 11	3"	4,070	2-4	150,24
*3021 12	4"	6,387	1-2	229,74

*Nuevas medidas / New sizes.

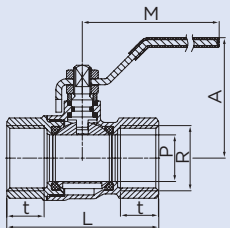

Ref. 3023 - 3023N



Válvula de esfera para montaje actuador

PN 40. Paso total. Construcción en latón UNE-EN 12165 cromado. Asientos PTFE. Extremos rosca gas (BSP) H-H ISO 228/1. Temp. máx. 110°C. Conexión a actuador s/ ISO 5211. Palanca en acero.

También disponible con rosca NPT (3023N)

Ball valve for direct assembling

PN 40. Full bore. Body chrome plated brass UNE-EN 12165 cromado. PTFE seats. Gas threaded ends (BSP) F-F ISO 228/1. Max. temp. 110°C. Actuator connection ISO 5211. Steel lever handle.

Also available NPT thread (3023N).

R	P	A	M	L	X	H	E	Q	ISO5211
1/2"	15	52	104	58	15	27	11	9	F03
3/4"	20	57	104	65	16	32	11	9	F03
1"	25	60	112	78	20	35	11	9	F04
1 1/4"	32	69	139	88	20	44	14	11	F05
1 1/2"	40	75	139	105	25	49	14	11	F05
2"	50	86	139	122	27	60	14	11	F05

3023 04	1/2"	0,265	10-80	12,88
3023 05	3/4"	0,334	6-60	18,20
3023 06	1"	0,572	4-48	26,97
3023 07	1 1/4"	0,890	5-30	53,28
3023 08	1 1/2"	1,254	4-24	62,54
3023 09	2"	1,886	2-12	101,69

Precios rosca NPT a consultar. / NPT thread prices on request.

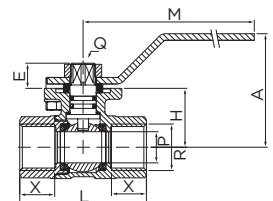

Ref. 3028



Válvula esfera serie ligera

PN 25. Paso estándar. Construcción en latón UNE-EN 12165 cromado. Asientos PTFE. Extremos rosca gas (BSP) H-H - ISO 228/1. Temp. máx. 110°C. Mando manual por palanca de acero.

Light ball valve

PN 25. Standard bore. Body chrome plated brass UNE-EN 12165. PTFE seats. Gas threaded ends (BSP) F-F - ISO 228/1. Max. Temp. 110°C. Steel lever manual control.

R	P	A	L	M
1/2"	14	46	44	84
3/4"	18	50	51	84
1"	23	57	61	92
1 1/4"	27	63	71	98
1 1/2"	34	74	81	113
2"	43	83	93	126
2 1/2"	52	96	118	158
3"	65	126	137	196
4"	79	137	163	265

CÓDIGO CODE	MEDIDA SIZE	PESO WEIGHT	CAJA / BOX CARTON	P.V.P. € PRICE €
3028 04	1/2"	0,133	8-192	3,65
3028 05	3/4"	0,199	8-128	5,23
3028 06	1"	0,317	8-96	8,45
3028 07	1 1/4"	0,426	6-72	11,63
3028 08	1 1/2"	0,704	2-24	20,11
3028 09	2"	1,005	2-24	28,19
3028 10	2 1/2"	1,852	6-12	63,98
3028 11	3"	3,103	4-8	101,87
3028 12	4"	4,815	2-4	161,23

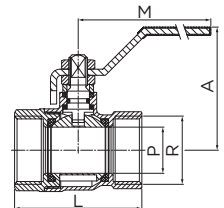

Ref. 3029 - 3022



Válvula de esfera

También disponible con rosca NPT (3022). PN 25. Paso total. Construcción en latón UNE-EN 12165 cromado. Asiento PTFE. Extremos roscados H-H - ISO 228/1. Temp. máx. 110°C. Mando manual por palanca de acero.

Ball valve

Also available NPT thread (3022). PN 25. Full bore. Body chrome plated brass UNE-EN 12165. PTFE seats. Treaded ends F-F - ISO 228/1. Max. temp. 110°C. Steel lever manual control.

R	P	A	L	M
1/4"	10	46	40	84
3/8"	10	46	43	84
1/2"	15	47	49	84
3/4"	20	58	56	98
1"	25	61	68	98
1 1/4"	32	74	80	126
1 1/2"	40	80	89	126
2"	50	91	104	158
2 1/2"	59	101	137	158
3"	72	131	158	196
4"	90	145	183	265

3029 02	1/4"	0,106	10-240	3,41
3029 03	3/8"	0,113	10-240	3,41
3029 04	1/2"	0,151	8-192	4,23
3029 05	3/4"	0,270	8-96	6,79
3029 06	1"	0,383	6-72	10,39
3029 07	1 1/4"	0,611	4-48	16,41
3029 08	1 1/2"	0,807	2-24	23,35
3029 09	2"	1,333	2-18	36,90
3029 10	2 1/2"	2,431	4-8	70,80
3029 11	3"	4,048	2-4	114,20
3029 12	4"	5,996	1-2	174,16

Precios rosca NPT a consultar / NPT thread prices on request

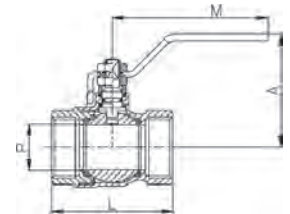

Ref. 3029H



Válvula de esfera (palanca roja)

PN 25. Paso total. Construcción en latón UNE-EN 12165 cromado. Asiento PTFE. Extremos roscados H-H - ISO 228/1. Temp. máx. 110°C. Mando manual por palanca de acero.

Ball valve (red handle)

PN 25. Full bore. Body chrome plated brass UNE-EN 12165. PTFE seats. Threaded ends F-F - ISO 228/1. Max. temp. 110°C. Steel lever manual control.

R	P	A	L	M
1/2"	15	47	49	84
3/4"	20	58	56	98
1"	25	61	68	98

3029H 04	1/2"	0,151	8-192	4,23
3029H 05	3/4"	0,254	8-96	6,79
3029H 06	1"	0,410	6-72	10,39

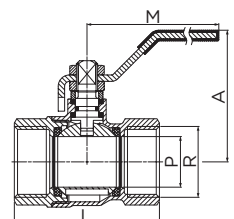

Ref. 3017N



Válvula de esfera

400-WOG. Paso total. Construcción en latón UNE-EN 12165. Asientos PTFE. Extremos rosca NPT - H-H según ANSI B 1.20.1. Temperatura máx. 110°C. Mando manual por palanca de acero.

Ball valve

400 WOG. Full bore. Brass construction UNE-EN 12165. PTFE seats. NPT threaded ends - F-F ANSI B 1.20.1. Max. temperature 110°C. Steel lever manual control.

R	P	A	L	M
1/2"	15	47	49	84
3/4"	20	58	56	98
1"	25	61	68	98
1 1/4"	32	74	80	126
1 1/2"	40	80	89	126
2"	50	91	104	158
2 1/2"	59	101	137	158
3"	72	131	158	196
4"	90	145	183	265

CÓDIGO CODE	MEDIDA SIZE	PESO WEIGHT	CAJA / BOX CARTON	P.V.P. € PRICE €
3017N 04	1/2"	0,160	8-144	4,49
3017N 05	3/4"	0,254	8-96	7,22
3017N 06	1"	0,395	6-72	10,99
3017N 07	1 1/4"	0,620	4-48	17,95
3017N 08	1 1/2"	0,865	2-24	25,01
3017N 09	2"	1,365	2-18	39,79
3017N 10	2 1/2"	2,490	4-8	76,51
3017N 11	3"	4,015	2-4	123,45
3017N 12	4"	6,169	1-2	188,21

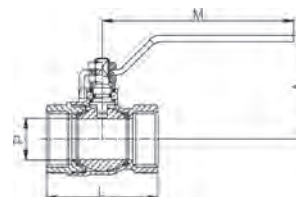

Ref. 3019N



Válvula de esfera (palanca amarilla)

PN 40. Paso total. Construcción en latón UNE-EN 12165. Asientos PTFE. Extremos rosca NPT - H-H según ANSI B 1.20.1. Temp. máx. 110°C. Mando manual por palanca de acero.

Ball valve (yellow handle)

PN 40. Full bore. Brass construction UNE-EN 12165. PTFE seats. Threaded ends NPT - F-F ANSI B 1.20.1. Max. temp. 110°C. Steel lever manual control.

R	P	A	L	M
1/4"	10	45	48	84
3/8"	10	45	50	84
1/2"	15	47	58	84
3/4"	20	58	65	98
1"	25	61	78	98
1 1/4"	32	74	88	126
1 1/2"	40	80	105	126
2"	50	91	122	126

3019N 02	1/4"	0,135	8-192	5,18
3019N 03	3/8"	0,135	8-192	5,18
3019N 04	1/2"	0,180	8-144	6,23
3019N 05	3/4"	0,300	8-96	9,11
3019N 06	1"	0,442	6-72	14,54
3019N 07	1 1/4"	0,701	4-48	22,31
3019N 08	1 1/2"	1,031	2-24	31,01
3019N 09	2"	1,581	2-18	48,23

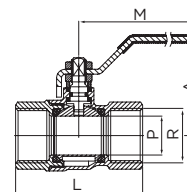

Ref. 3030I



Válvula de esfera. Palanca de acero inoxidable.

PN 25. Paso total. Construcción en latón UNE-EN 12165 niquelado. Asientos PTFE. Eje con doble o-ring. Extremos roscados ISO 228/1 - H-H. Temp. máx. 110°C. Mando manual por palanca de acero inoxidable AISI 304.

Ball valve. Stainless Steel lever manual control.

PN 25. Full bore. Body nickel plated brass UNE-EN 12165. PTFE seats. Stem with double o-ring. Threaded ends ISO 228/1 - F-F. Max. temp. 110°C. AISI 304 stainless Steel lever manual control.

R	P	A	L	M
1/2"	15	45	49	84
3/4"	20	53	56	93
1"	25	56	70	93
1 1/4"	32	66	79	115
1 1/2"	40	77	89	126
2"	50	86	104	158

3030I 04	1/2"	0,149	8-192	4,71
3030I 05	3/4"	0,244	8-96	7,42
3030I 06	1"	0,374	6-72	11,47
3030I 07	1 1/4"	0,589	4-48	18,54
3030I 08	1 1/2"	0,855	2-24	26,34
3030I 09	2"	1,349	2-18	41,06

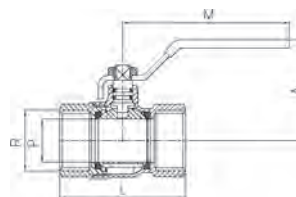

Ref. 3031

NEW



Válvula de esfera latón DZR. Palanca de acero inoxidable AISI 304

PN 25. Paso total. Construcción en latón anticorrosión DZR CW602N según UNE-EN 12165 niquelado. Asientos PTFE. Ejes con doble o-ring. Extremos roscados ISO 228/1 - H-H. Temp. máx. 110°C. Mando manual por palanca de acero inoxidable AISI 304.

DZR brass ball valve. AISI 304 stainless steel lever manual control

PN 25. Full bore. Body nickel plated CW602N DZR anticorrosion brass construction UNE-EN 12165. PTFE seats. Stem with double o-ring. Threaded ends ISO 228/1 - F-F. Max. temp. 110°C. AISI 304 stainless steel lever manual control.

R	P	A	L	M
1/2"	14,2	45	49	84
3/4"	19	53	56	93
1"	24	56	70	93
1 1/4"	30,2	68	79	115
1 1/2"	37,3	77	89	126
2	46,5	86	104	158

3031 04	1/2"	0,149	8-192	2,52
3031 05	3/4"	0,248	8-96	4,04
3031 06	1"	0,381	6-72	6,19
3031 07	1 1/4"	0,596	4-36	9,97
3031 08	1 1/2"	0,870	2-24	14,29
3031 09	2"	1,341	2-18	22,15

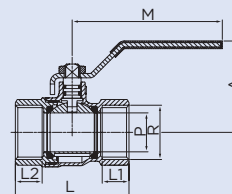

Ref. 3032



Válvula de esfera con tomas laterales

PN 25. Paso total. Construcción en latón UNE-EN 12165 cromado. Asientos PTFE. Extremos rosca gas (BSP) H-H - ISO 228/1. Temp. máx. 110°C. Mando manual por palanca acero. 2 tomas laterales 1/4" - 1 de ellas con tapón.

Ball valve with side inlets

PN 25. Full bore. Body chrome plated brass UNE-EN 12165. PTFE seats. Gas threaded ends (BSP) F-F - ISO 228/1. Max. temp. 110°C. Steel lever manual control. Two-sided 1/4" inlet - plug on one side.

R	P	A	L	M
1/2"	15	47	52	84
3/4"	20	58	60	98
1"	25	61	72	98

CÓDIGO CODE	MEDIDA SIZE	PESO WEIGHT	CAJA / BOX CARTON	P.V.P. € PRICE €
-------------	-------------	-------------	-------------------	------------------

3032 04	1/2"	0,180	10-100	6,42
3032 05	3/4"	0,296	8-80	10,31
3032 06	1"	0,420	5-50	14,50

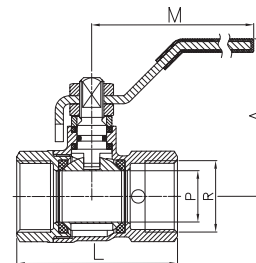

Ref. 3033



Válvula de esfera

PN 25. Paso total. Construcción en latón UNE-EN 12165 cromado. Asientos PTFE. Extremos rosca gas (BSP) M-M - ISO 228/1. Temp. máx. 110°C. Mando manual por palanca acero.

Ball valve

PN 25. Full bore. Body chrome plated brass UNE-EN 12165. PTFE seats. Gas threaded ends (BSP) M-M - ISO 228/1. Max. Temp. 110°C. Steel lever manual control.

R	P	A	L	M
1/2"	15	47	56	84
3/4"	20	58	65	98
1"	25	61	78	98

3033 04	1/2"	0,160	10-140	5,77
3033 05	3/4"	0,273	8-64	9,70
3033 06	1"	0,400	6-48	13,84

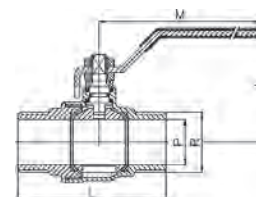

Ref. 3034 - 3034H



Válvula de esfera (3034 palanca azul - 3034H palanca roja)

PN 25. Paso total. Construcción en latón UNE-EN 12165 cromado. Asientos PTFE. Extremos rosca gas (BSP) M-H ISO 228/1. Temp. máx. 110°C. Mando manual por palanca de acero.

Ball valve (3034 blue handle - 3034H red handle)

PN 25. Full bore. Body chrome plated brass UNE-EN 12165. PTFE seats. Gas threaded ends (BSP) M-F ISO 228/1. Max. temp. 110°C. Steel lever manual control.

R	P	A	L	M
1/4"	10	46	48	84
3/8"	10	46	49	84
1/2"	15	47	56	84
3/4"	20	58	64	98
1"	25	61	76	98
1 1/4"	32	74	87	126
1 1/2"	40	80	95	126
2"	50	91	109	158
1/2"	15	47	55	84

3034 02	1/4"	0,115	10-240	4,10
3034 03	3/8"	0,114	10-240	4,10
3034 04	1/2"	0,146	8-192	4,88
3034 05	3/4"	0,263	6-108	8,08
3034 06	1"	0,390	6-72	12,01
3034 07	1 1/4"	0,634	4-48	18,75
3034 08	1 1/2"	0,835	2-24	27,27
3034 09	2"	1,273	2-18	41,20
3034H 04	1/2"	0,160	8-192	4,88
3034H 05	3/4"	0,291	6-108	8,08
3034H 06	1"	0,406	6-72	12,01

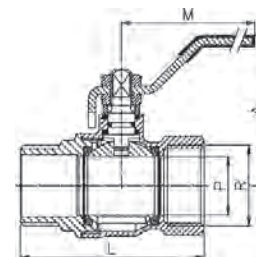

Ref. 3034I

NEW



Válvula de esfera. Palanca de acero inoxidable

PN 25. Paso total. Construcción en latón UNE-EN 12165 niquelado. Asientos PTFE. Eje con doble o-ring. Extremos roscados ISO 228/1 - M-H. Temp. máx. 110°C. Mando manual por palanca de acero inoxidable AISI 304.

Ball valve. Stainless steel lever manual control

PN 25. Full bore. Body nickel plated brass UNE-EN 12165. PTFE seats. Stem with double o-ring. Threaded ends ISO 228/1 - M-F. Max. temp. 110°C. AISI 304 stainless AISI 304 steel lever manual control.

R	P	A	L	M
1/2"	14,2	45	57	84
3/4"	19	53	63,5	93
1"	24	56	76,6	93
1 1/4"	30,2	68	84,8	115

3034I 04	1/2"	0,163	8-152	6,17
3034I 05	3/4"	0,261	6-60	9,95
3034I 06	1"	0,396	6-54	14,80
3034I 07	1 1/4"	0,623	4-36	23,10

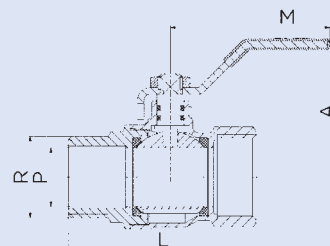

Ref. 3035 - 3037

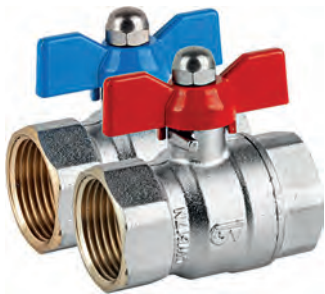

Válvula de esfera (3035 palomilla azul - 3037 palomilla roja)

PN 25. Paso total. Construcción en latón UNE-EN 12165 cromado. Asiento PTFE. Extremos rosca gas (BSP) H-H. ISO 228/1. Temp. máx. 110°C. Mando manual por palomilla aluminio.

Ball valve (3035 blue butterfly handle - 3037 red butterfly handle)

PN 25. Full bore. Body chrome plated brass UNE-EN 12165. PTFE seats. Gas threaded ends (BSP) F-F - ISO 228/1. Max. temp. 110°C. Aluminium butterfly handle.

R	P	A	L	M
1/4"	10	38	40	50
3/8"	10	38	43	50
1/2"	15	40	49	50
3/4"	20	50	56	62
1"	25	53	68	62

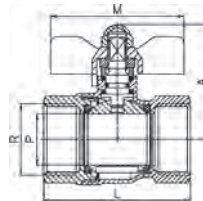

CÓDIGO CODE	MEDIDA SIZE	PESO WEIGHT	CAJA / BOX CARTON	P.V.P. € PRICE €
3035 02	1/4"	0,089	12-288	3,81
3035 03	3/8"	0,093	12-288	3,81
3035 04	1/2"	0,133	10-180	4,70
3035 05	3/4"	0,223	6-108	7,64
3035 06	1"	0,357	5-90	11,62
3037 02	1/4"	0,125	12-288	3,81
3037 03	3/8"	0,100	12-288	3,81
3037 04	1/2"	0,129	10-240	4,70
3037 05	3/4"	0,218	6-108	7,64
3037 06	1"	0,348	5-90	11,62

Ref. 3036 - 3038



Válvula de esfera (3036 palomilla azul - 3038 palomilla roja)

PN 25. Paso total. Construcción en latón UNE-EN 12165 cromado. Asientos PTFE. Extremos rosca gas (BSP) M-H - ISO 228/1. Temp. máx. 110°C. Mando manual por palomilla aluminio.

Ball valve (3036 blue butterfly handle - 3038 red butterfly handle)

PN 25. Full bore. Body chrome plated brass UNE-EN 12165. PTFE seats. Gas threaded ends M-F (BSP) - ISO 228/1. Max. temp. 110°C. Aluminium butterfly handle.

R	P	A	L	M
1/4"	10	38	48	50
3/8"	10	38	49	50
1/2"	15	40	56	50
3/4"	20	50	64	62
1"	25	53	76	62

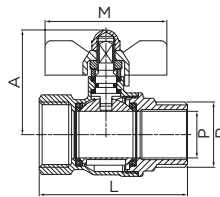

3036 02	1/4"	0,093	12-288	4,04
3036 03	3/8"	0,100	12-288	4,04
3036 04	1/2"	0,139	10-180	4,98
3036 05	3/4"	0,251	6-108	7,99
3036 06	1"	0,360	5-90	12,08
3038 02	1/4"	0,091	12-288	4,04
3038 03	3/8"	0,095	12-288	4,04
3038 04	1/2"	0,140	10-180	4,98
3038 05	3/4"	0,230	6-108	7,99
3038 06	1"	0,362	5-90	12,08

Ref. 3046



Válvula de esfera con racor dos piezas

PN 25. Paso total. Construcción en latón UNE-EN 12165 cromado. Asientos PTFE. Extremos rosca gas (BSP) M-H ISO 228/1. Temp. máx. 110°C. Mando manual por palomilla aluminio.

Ball valve with 2 pieces connector

PN 25. Full bore. Body chrome plated brass UNE-EN 12165. PTFE seats. Gas threaded ends (BSP) M-F - ISO 228/1. Max. Temp. 110°C. Aluminium butterfly handle for manual control.

R	P	A	L	M
1/2"	15	36	69	50
3/4"	20	44	76	62
1"	25	48	92	62
1 1/4"	30	57	106	78

3046 04	1/2"	0,170	18-144	6,97
3046 05	3/4"	0,304	10-80	11,59
3046 06	1"	0,479	6-48	17,25
3046 07	1 1/4"	0,696	4-32	28,27

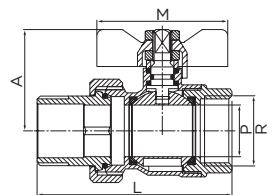

Ref. 3075



Válvula de esfera escuadra M-H con racor dos piezas

PN 25. Paso total. Construcción en latón UNE-EN 12165 cromado. Asientos PTFE. Extremos rosca gas (BSP) M-H - ISO 228/1. Temp. máx. 110°C. Mando manual por palomilla aluminio.

Ball angle valve M-F with 2 pieces detachable connector

PN 25. Full bore. Body chrome plated brass UNE-EN 12165. PTFE seats. Gas threaded end (BSP) M-F - ISO 228/1. Max. Temp. 110°C. Aluminium butterfly handle.

R	P	A	L	M
3/4"	20	87	58	62
1"	25	97	63	62

3075 05	3/4"	0,350	8-48	15,27
3075 06	1"	0,549	5-30	22,64

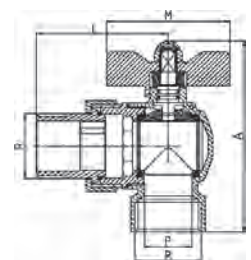

Ref. 3048



Válvula de esfera con racor dos piezas

PN 25. Paso total. Construcción en latón UNE-EN 12165 cromado. Asientos PTFE. Extremos rosca gas (BSP) M-H - ISO 228/1. Temp. máx. 110°C. Mando manual por palanca de acero.

Ball valve with 2 pieces connector

PN 25. Full bore. Body chrome plated brass UNE-EN 12165. PTFE seats. Gas threaded ends (BSP) M-F - ISO 228/1. Max. Temp. 110°C. Steel lever manual control.

R	DN	A	L	M
1/2"	15	47	69	84
3/4"	20	58	76	98
1"	25	61	92	98
1 1/4"	32	74	106	126
1 1/2"	40	80	119	126
2"	50	91	141	158

CÓDIGO CODE	MEDIDA SIZE	PESO WEIGHT	CAJA / BOX CARTON	P.V.P. € PRICE €
3048 04	1/2"	0,175	8-192	7,47
3048 05	3/4"	0,340	6-72	12,29
3048 06	1"	0,476	4-48	18,54
3048 07	1 1/4"	0,752	2-24	29,54
3048 08	1 1/2"	1,103	2-24	46,35
3048 09	2"	1,662	2-18	69,42

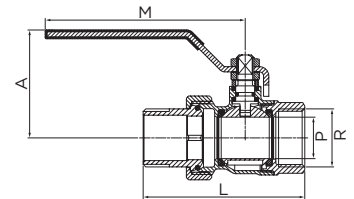

Ref. 3084



Válvula de esfera mando cuadradillo

PN 25. Paso total. Construcción en latón UNE-EN 12165 cromado. Asientos PTFE. Extremos rosca gas (BSP) H-H - ISO 228/1. Temp. máx. 110°C. Accionamiento mediante cuadradillo.

Square handle ball valve

PN 25. Full bore. Body chrome plated brass UNE-EN 12165. PTFE seats. Gas threaded ends (BSP) F-F - ISO 228/1. Max. temp. 110°C. Square handle.

R	P	A	L	M
1/2"	15	38	49	20
3/4"	20	49	56	20
1"	25	52	68	20
1 1/4"	32	63	80	30
1 1/2"	40	69	89	30
2"	50	80	104	30
2 1/2"	60	89	137	30
3"	74	117	158	30
4"	92	131	183	30

3084 04	1/2"	0,154	15-210	6,08
3084 05	3/4"	0,245	10-140	9,56
3084 06	1"	0,380	8-80	14,44
3084 07	1 1/4"	0,587	5-40	23,08
3084 08	1 1/2"	0,775	2-16	33,55
3084 09	2"	1,240	2-16	51,31
3084 10	2 1/2"	2,365	1-8	97,59
3084 11	3"	-	1-4	147,73
3084 12	4"	5,720	1-2	239,88

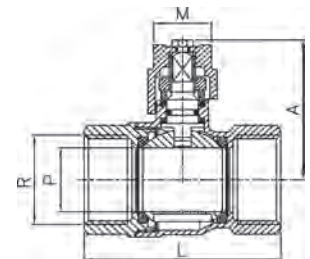

Ref. 3085



Válvula de esfera mando cuadradillo

PN 25. Paso total. Construcción en latón UNE-EN 12165 cromado. Asientos PTFE. Extremos rosca gas (BSP) M-H - ISO 228/1. Temp. máx. 110°C. Accionamiento mediante cuadradillo.

Square handle ball valve

PN 25. Full bore. Body chrome plated brass UNE-EN 12165. PTFE seats. Gas threaded ends (BSP) M-F - ISO 228/1. Max. temp. 110°C. Square handle.

R	P	A	L	M
1/2"	15	38	55	20
3/4"	20	49	64	20
1"	25	52	76	20
1 1/4"	32	63	87	30
1 1/2"	40	69	89	30
2"	50	80	109	30

3085 04	1/2"	0,160	10-180	6,46
3085 05	3/4"	0,260	6-108	10,15
3085 06	1"	0,395	6-72	15,24
3085 07	1 1/4"	0,630	5-40	23,79
3085 08	1 1/2"	0,850	2-20	33,53
3085 09	2"	1,300	2-16	51,44

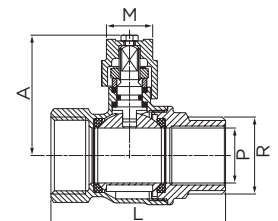

Ref. 3088



Válvula de esfera tubería PE

PN 25. Paso total. Construcción en latón s/UNE-EN 12165. Asientos PTFE. Extremos conexión a tubería mediante sistema de apriete diseño Genebre "RAC-GE". Temperatura de trabajo de -20°C a +110°C. Aplicable para la unión de tubo de polietileno de baja-media y alta densidad. Mando manual por palanca de acero.

Ball valve for PE pipe

PN 25. Full bore. Brass construction UNE-EN 12165. PTFE seats. Genebre's designed "RAC-GE" air tight system ends for connection to pipe. Working temp.: -20 °C to 110 °C. Applicable for the connection of low-medium and high density polyethylene pipe. Steel lever manual control.

DN	Ø PE	P	A	L	M
15	20	14	47	77	84
20	25	19	58	91	98
25	32	24	61	109	98

3088 04	20 x 20	0,240	6-108	7,31
3088 05	25 x 25	0,378	6-72	12,12
3088 06	32 x 32	0,574	3-36	18,16

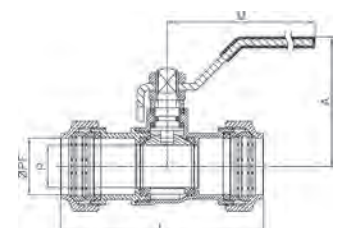

Ref. 3089



Válvula de esfera tubería PE

PN 25. Paso total. Construcción en latón s/UNE-EN 12165. Extremos roscado gas hembra s/ISO 228/1. Asiento PTFE. Conexión a tubería mediante sistema de apriete diseño Genebre "RAC-GE". Temperatura de trabajo de -20°C a + 110°C. Aplicable para la unión de tubo de polietileno de baja-media y alta densidad. Mando manual por palanca de acero.

Ball valve for PE pipe

PN 25. Full bore. Brass UNE-EN 12165. Female gas threaded ends ISO 228/1. PTFE Seats. Genebre's designed "RAC-GE" air tight system for connection to pipe. Working temp.: -20 °C to 110 °C. Applicable for the connection of low-medium and high density polyethylene pipe. Steel lever manual control.

DN	Ø PE	P	A	L	M
15	20	14	47	61	84
20	25	19	58	71	98
25	32	24	61	86	98

CÓDIGO CODE	MEDIDA SIZE	PESO WEIGHT	CAJA / BOX CARTON	P.V.P. € PRICE €
-------------	-------------	-------------	-------------------	------------------

3089 04	1/2" x 20	0,186	8-144	6,21
3089 05	3/4" x 25	0,316	6-72	10,31
3089 06	1" x 32	0,475	4-48	15,41

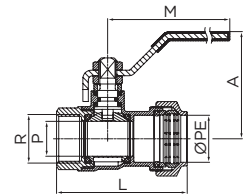

Ref. 3272E - 3282E



Válvula de esfera 3 vías para montaje actuador tipo "L" (3272E) y tipo "T" (3282E)

PN 25. Paso total. Construcción en latón niquelado UNE-EN 12165. Asientos PTFE. Extremos rosca gas (BSP) H ISO 228/1. Obturador esférico en 2/3 vías en forma "L" / "T". Juntas tóricas EPDM. Temp. máx. 150°C. Mando manual por palanca. Conexión a actuador s/ ISO 5211.

3 ways ball valve for direct assembling type "L" (3272E) and type "T" (3282E)

PN 25. Full bore. Body nickel plated brass UNE-EN 12165. PTFE seats. Gas threaded ends (BSP) F SO 228/1. 2/3 ways spherical seal type "L" / "T". EPDM o-rings. Max. temp. 150°C. Steel lever manual control. Direct assembling ISO 5211.

R	P	A	B	L	M	Q	ISO 5211
1/2"	15	58	33	74	104	9	F03
3/4"	20	63	38	85	111	9	F04
1"	25	68	43	97	111	9	F04

3272E 04	1/2"	0,443	4-60	24,68
3272E 05	3/4"	0,682	2-30	37,97
3272E 06	1"	1,012	2-24	59,69

3282E 04	1/2"	0,440	4-60	24,68
3282E 05	3/4"	0,675	2-30	37,97
3282E 06	1"	1,000	2-24	59,69

ART.	TIPO	PASO	1	2	3	4
3272E	L	1/3	2/3	1/3	1/3	2/3
3282E	T	1/3	2/3	1/3	1/3	2/3

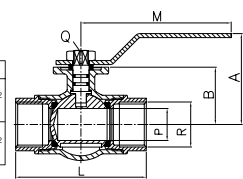

Ref. 3070 - 3080



Válvula esfera 3 vías tipo "L" (3070) y Tipo "T" (3080)

PN 25. Construcción en latón UNE-EN 12165 cromado. Asientos de PTFE. Extremos rosca gas (BSP) H - ISO 228/1. Obturador esférico en dos/tres vías en forma "L" / "T". Temp. máx. 120°C. Mando manual por palanca.

Type "L" (3070) and Type "T" (3080) 3 way ball valve

PN 25. Chrome plated brass UNE-EN 12165 body. 4 PTFE seats. Gas threaded ends (BSP) F - ISO 228/1. Spherical seal 2/3 way type "L" / "T". Max. Temp. 120°C. Manual control lever.

R	P	A	L	M
1 1/4"	29	100	118	170
1 1/2"	36	120	138	170
2"	45	130	162	260

3070 07	1 1/4"	2,257	2-16	109,06
3070 08	1 1/2"	3,369	2-6	156,36
3070 09	2"	5,452	2-4	231,93

3080 07	1 1/4"	2,232	2-16	109,06
3080 08	1 1/2"	3,358	2-6	156,36
3080 09	2"	5,466	2-4	231,93

ART.	TIPO	PASO	1	2	3	4
3070	L	1/3	2/3	1/3	1/3	2/3
3080	T	1/3	2/3	1/3	1/3	2/3

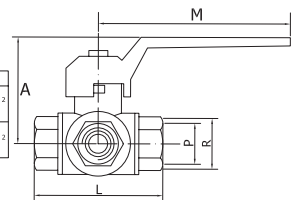

Ref. 3096 - 3096H



Válvula esfera mini (3096 palanca azul - 3096H palanca roja)

PN 16. Paso reducido. Construcción en latón cromado UNE-EN 12165. Asientos PTFE. Extremos rosca gas (BSP) H-H según ISO 228/1. Temp. máx. 110°C. Mando palomilla aluminio.

Mini ball valve (3096 blue handle - 3096H red handle)

PN 16. Reduced bore. Body chrome plated brass UNE-EN 12165. PTFE seats. Gas threaded ends (BSP) F-F ISO 228/1. Max. temp. 110°C. Butterfly handle operated aluminium

R	P	A	L	M
1/8"	6,5	28	37	22
1/4"	6,5	28	39	22
3/8"	8	30	42	22
1/2"	10	33	46	22
3/4"	12,5	36	55	22

3096 01	1/8"	0,050	20-480	2,98
3096 02	1/4"	0,050	20-480	2,98
3096 03	3/8"	0,075	15-360	3,32
3096 04	1/2"	0,105	10-240	4,31
3096 05	3/4"	0,170	8-192	7,67

3096H 01	1/8"	0,050	20-480	2,98
3096H 02	1/4"	0,050	20-480	2,98
3096H 03	3/8"	0,072	15-360	3,32
3096H 04	1/2"	0,101	10-240	4,31
3096H 05	3/4"	0,172	8-192	7,67

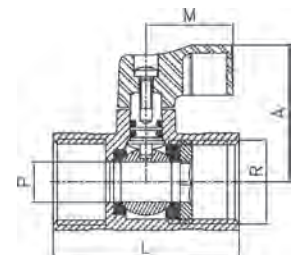

Ref. 3097 - 3097H



Válvula esfera mini (3097 palanca azul - 3097H palanca roja)

PN 16. Paso reducido. Construcción en latón cromado UNE-EN 12165. Asientos PTFE. Extremos rosca gas (BSP) M-H según ISO 228/1. Temp. máx. 110°C. Mando palomilla aluminio.

Mini ball valve (3097 blue handle - 3097H red handle)

PN 16. Reduced bore. Body chrome plated brass UNE-EN 12165. PTFE seats. Gas threaded ends (BSP) M-F ISO 228/1. Max. temp. 110°C. Butterfly handle operated aluminium.

R	P	A	L	M
1/8"	6,5	28	36	22
1/4"	6,5	28	37	22
3/8"	8	30	40	22
1/2"	10	33	44	22
3/4"	12,5	36	52	22

CÓDIGO CODE	MEDIDA SIZE	PESO WEIGHT	CAJA / BOX CARTON	P.V.P. € PRICE €
3097 01	1/8"	0,045	20-480	2,98
3097 02	1/4"	0,045	20-480	2,98
3097 03	3/8"	0,065	15-360	3,32
3097 04	1/2"	0,100	10-240	4,31
3097 05	3/4"	0,160	8-192	7,67
3097H 01	1/8"	0,045	20-480	2,98
3097H 02	1/4"	0,045	20-480	2,98
3097H 03	3/8"	0,065	15-360	3,32
3097H 04	1/2"	0,100	10-240	4,31
3097H 05	3/4"	0,160	8-192	7,67

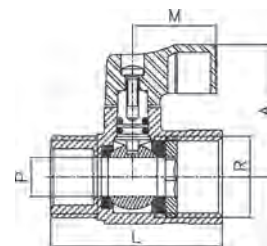

Ref. 3451



Válvula de esfera mini con tuerca loca

PN 16. Paso reducido. Construcción en latón cromado UNE-EN 12165. Asientos PTFE. Extremos rosca gas (BSP) M-H según ISO 228/1. Temp. máx. 110°C. Mando palomilla aluminio.

Mini ball valve with free nut

PN 16. Reduced bore. Body chrome plated brass UNE-EN 12165. PTFE Seats. M-F gas (BSP) threaded ends according ISO 228/1. Max. temp. 110°C. Aluminium butterfly handle.

R1	R2	P	A	L	M
1/2"	1/2"	10	33	49	22
1/2"	3/4"	10	33	49	22
3/4"	3/4"	12,5	36	54	22

3451 04 04	1/2" x 1/2"	0,120	10-80	8,20
3451 04 05	1/2" x 3/4"	0,130	25-150	8,99
3451 05 05	3/4" x 3/4"	0,190	25-150	9,92

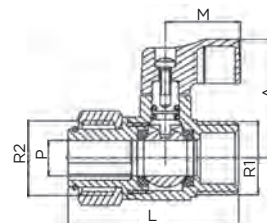

Ref. 3396



Válvula esfera mini

PN 16. Paso reducido. Construcción en latón cromado UNE-EN 12165. Asientos PTFE. Barra hexagonal cromada. Extremos rosca gas (BSP) H-H según ISO 228/1. Temp. máx. 110°C. Mando palomilla aluminio.

Mini ball valve

PN 16. Reduced bore. Hexagonal body chrome plated brass UNE-EN 12165. PTFE seats - female gas threaded ends (BSP) ISO 228/1. Max. Temp. 110°C. Butterfly handle operated aluminium.

R	P	A	L	M
1/8"	6	26	37	23
1/4"	8	26	40	23
3/8"	8	27	42	23
1/2"	10	28	45	23
3/4"	12	30	53	23

3396 01	1/8"	0,089	15-360	4,09
3396 02	1/4"	0,091	15-360	4,09
3396 03	3/8"	0,082	15-360	4,09
3396 04	1/2"	0,099	10-240	5,00
3396 05	3/4"	0,193	8-192	9,55

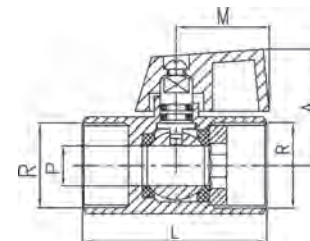

Ref. 3397



Válvula esfera mini

PN 16. Paso reducido. Construcción en latón cromado UNE-EN 12165. Asientos PTFE. Barra hexagonal cromada. Extremos rosca gas (BSP) M-H - según ISO 228/1. Temp. máx. 110°C. Mando palomilla aluminio.

Mini ball valve

PN 16. Reduced bore. Hexagonal body, chrome plated brass UNE-EN 12165. PTFE seats. M-F gas threaded ends (BSP) ISO 228/1. Max. Temp. 110°C. Aluminium butterfly handle.

R	P	A	L	M
1/8"	6	26	37	23
1/4"	8	26	40	23
3/8"	8	27	41	23
1/2"	10	28	45	23
3/4"	12	30	53	23

3397 01	1/8"	0,078	15-360	4,09
3397 02	1/4"	0,075	15-360	4,09
3397 03	3/8"	0,073	15-360	4,09
3397 04	1/2"	0,108	10-240	5,00
3397 05	3/4"	0,176	8-192	9,55

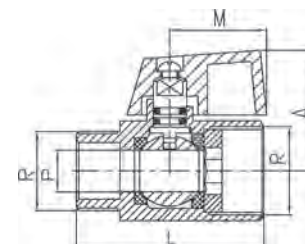

Ref. 70302

NEW

Válvula esfera esquadra con tuerca loca

PN 16. Paso total. Construcción en latón cromado según UNE-EN 12165. Asientos PTFE. Extremos roscados rosca gas (BSP) M-H - ISO 228/1. Temp. máx. 110°C. Mando manual por palanca de aluminio azul.

Ball angle valve with free nut

PN 16. Full bore. Body chrome plated brass UNE-EN 12165. PTFE seats. Gas threaded ends (BSP) M-F, ISO 228/1. Max. temp. 110°C. Blue aluminium butterfly handle.

R	P	A	L	M
1/2"	10	59	29	33



CÓDIGO CODE	MEDIDA SIZE	PESO WEIGHT	CAJA / BOX CARTON	P.V.P. € PRICE €
70302 04 00	1/2" x 1/2"	0,111	10-160	5,83

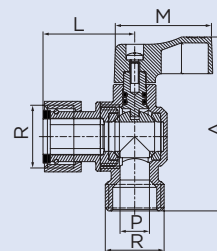

Ref. 70304

NEW

Valvula esfera esquadra con tuerca loca

PN 25 Paso total. Construcción en latón cromado según UNE-EN 12165. Asientos PTFE. Extremos roscados rosca gas (BSP) M-H - ISO 228/1. Temp. máx. 110°C. Mando manual por palanca de aluminio rojo.

Ball angle valve with free nut

PN 25. Full bore. Body chrome plated brass UNE-EN 12165. PTFE seats. Gas threaded ends (BSP) M-F, ISO 228/1. Max. temp. 110°C. Red aluminium butterfly handle.

R	P	A	L	M
3/4"	14	65	33	33



70304 05 00	3/4" x 3/4"	0,175	10-120	7,34
-------------	-------------	-------	--------	------

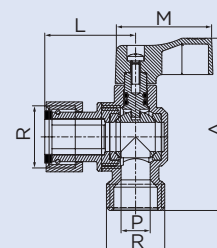

Ref. 3051

Válvula esfera recta con palomilla tuerca loca

PN 16. Paso reducido. Construcción en latón según UNE-EN 12165. Asientos PTFE. Rosca gas (BSP) M-H tuerca loca según ISO 228/1. Temp. máx. 110°C. Accionamiento mediante palomilla de color rojo.

Straight ball valve with butterfly handle - free nut

PN 16. Reduced bore. Body brass UNE-EN 12165. PTFE seats. Gas threaded (BSP) M-F free nut - ISO 228/1. Max. temp. 110°C. Butterfly red handle operated.

R	P	A	L	M
1/2" x 3/4"	10	34	45	40



3051 04 05	1/2" x 3/4"	0,135	25-200	8,99
------------	-------------	-------	--------	------

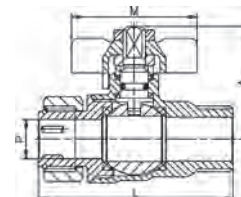

Ref. 3044

Válvula de descarga para caldera

PN 25. Paso total. Construcción en latón níquelado UNE-EN 12165. Asientos PTFE. Extremos rosca gas (BSP) M ISO 228/1 y conexión a manguera Ø 15 con tapón seguridad. Temp. máx. 110°C. Mando manual por palomilla aluminio color rojo.

Boiler discharge valve

PN 25. Full bore. Body brass UNE-EN 12165 Nickel-plated finishing. PTFE seats. Threaded end male ISO 228/1 and Ø 15 hose connection with safety cap. Max. Temp. 110°C. Aluminium butterfly red handle.

R x B	DN	H	L	M
G 1/2" x Ø15	10	34	72	35,5



3044 04	1/2" x Ø15	0,145	8-192	5,48
---------	------------	-------	-------	------

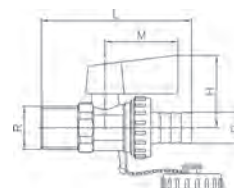

Ref. 3081

Válvula esfera soldar

PN 16. Paso total. Construcción en latón UNE-EN 12165. Asientos PTFE. Extremos para soldar. Temp. máx. 110°C. Mando manual por palanca acero.

Welding ball valve

PN 16. Full bore. Brass body UNE-EN 12165. PTFE seats. Welding ends. Max. Temp. 110°C. Steel lever manual control.

D	DN	A	L	M
Ø15	12	46	57	84
Ø18	15	47	64	84
Ø22	20	58	72	98
Ø28	25	61	85	98
Ø35	32	75	96	135
Ø42	40	80	115	135
Ø54	50	90	140	165



3081 15	Ø15	0,128	12-192	4,61
3081 18	Ø18	0,157	10-160	5,17
3081 22	Ø22	0,255	8-96	8,43
3081 28	Ø28	0,370	6-72	12,23
3081 35	Ø35	0,600	2-36	20,78
3081 42	Ø42	0,860	1-18	31,82
3081 54	Ø54	1,439	1-12	51,64

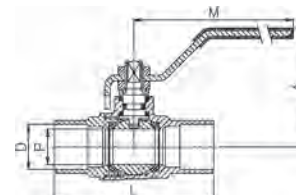

Ref. 3082



Válvula esfera soldar

PN 16. Paso total. Construcción en latón según UNE-EN 12165. Asientos PTFE. Extremos para soldar. Temp. máx. 110°C. Mando manual por palomilla aluminio.

Welding ball valve

PN 16. Full bore. Brass body UNE-EN 12165. PTFE seats. Welding ends. Max. Temp. 110°C. Aluminium butterfly handle operated.

D	DN	A	L	M
Ø15	12	39	57	50
Ø18	15	40	64	50
Ø22	20	50	72	62

CÓDIGO CODE	MEDIDA SIZE	PESO WEIGHT	CAJA / BOX CARTON	P.V.P. € PRICE €
3082 15	Ø15	0,109	10-240	4,47
3082 18	Ø18	0,137	8-192	5,30
3082 22	Ø22	0,222	5-120	8,35

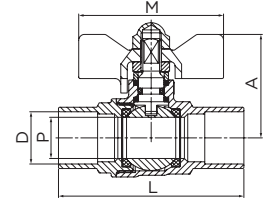

Ref. K3000



Kit prolongador

Distanciador de palanca en latón cromado según UNE-EN 12165. Para aplicar a los artículos indicados en la siguiente tabla.

Extension kit

Lever spacer in chromed brass UNE-EN 12165. For use of the items indicated in the table below.

Ref.	X (mm)	3020, 3021, 3022, 3029, 3032, 3035, 3034	3081
K3000 02	40	1"	Ø22-Ø28
K3000 03	51	1 1/4" - 1 1/2"	Ø35-Ø42
K3000 04	55	2" - 2 1/2"	Ø54

K3000 02	1"	0,096	20-200	5,20
K3000 03	1 1/4" - 1 1/2"	0,148	10-100	7,56
K3000 04	2" - 2 1/2"	0,240	10-100	11,83

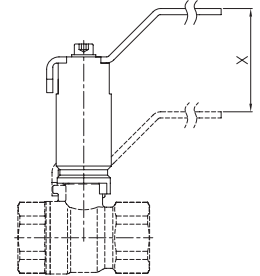

Ref. 3234



Válvula esfera prolongada para aislamiento

PN 25. Paso total. Construcción en latón UNE-EN 12165. Asientos PTFE. Extremos rosca gas (BSP) H-H - ISO 228/1. Temp. máx. 110°C. Mando manual palanca acero.

Ball valve with extension for isolation

PN 25. Full bore. Brass construction UNE-EN 12165. PTFE seats. Gas threaded ends (BSP) F-F - ISO 228/1. Max. Temp. 110°C. Steel lever for manual control.

R	DN	L	A	M
G 1/2"	15	49	81,5	84

3234 04	1/2"	0,188	5-90	9,01
---------	------	-------	------	------

Precios a consultar / Prices on request

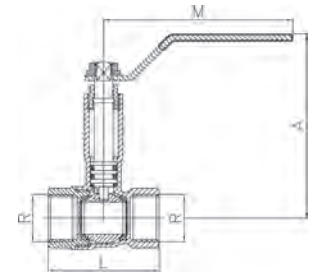

Ref. 3235



Válvula esfera prolongada para aislamiento

PN 25. Paso total. Construcción en latón cromado UNE-EN 12165. Asientos PTFE. Extremos rosca gas (BSP) H-H - ISO 228/1. Temp. máx. 110°C. Mando manual palomilla aluminio.

Ball valve with extension for isolation

PN 25. Full bore. Body chrome plated brass construction UNE-EN 12165. PTFE seats. Gas threaded ends (BSP) F-F - ISO 228/1. Max. Temp. 110°C. Aluminium butterfly handle.

R	DN	L	A	M
G 1/2"	15	49	75	50
G 3/4"	20	56	78	50

3235 04	1/2"	0,195	5-120	9,01
3235 05	3/4"	0,280	4-96	12,20

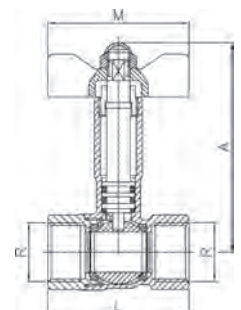

VÁLVULAS EMPOTRAR / BUILT-IN BALL VALVE

ELEMENTOS / ELEMENTS

1. Cuerpo / Body
2. Tapa / Cap
3. Esfera / Ball
4. Eje + Juntas tóricas / Stem + O'rings
5. Asientos / Ball seats
6. Tuerca / Nut
7. Anillo PTFE / PTFE ring.
8. Juntas tóricas / O'rings



CARACTERÍSTICAS DE LAS VÁLVULAS

- Válvulas esfera para uso ON/OFF, abierto - cerrado
- Construidas en latón UNE-EN 12165, resistente a la corrosión
- Acabado cromado o en color latón.
- Conexiones roscadas G ISO 228/1, extremos soldar, para tubería de polibutileno, casquillos multicapa y PEX-a
- Disponibles en PN16 y PN25
- Disponibles diferentes dimensiones y pasos
- Disponibles diferentes manetas con florón (M3055, M3057), mando oculto (M3054) y un prolongador del eje de las válvulas (K3052)

VALVES CHARACTERISTICS

- Ball valves for ON/OFF use, open - closed
- Construction in EN 12165 brass, corrosion resistant
- Chrome plated or brass colour finished
- Threaded ends G ISO 228/1, welding ends, polybutylene pipe, multilayer pipe and PEX-a pipe
- Available in PN16 and PN25
- Available several dimensions and bores
- Available different handles with cover (M3055, M3057), Hidden control (M3054) and Stretcher for valve stem (K3052)

Ref. 3056



Válvula de esfera empotrar rosca gas

PN 25. Paso total. Construcción en latón según UNE-EN 12165. Asientos PTFE. Extremos roscados gas (BSP) H-H ISO 228/1. Temp. máx. 110 °C.

Built-in gas threaded ball valve

PN 25. Full bore. Body brass UNE-EN 12165. PTFE seats. Gas threaded ends (BSP) F-F - ISO 228/1. Max. Temp. 110°C.

R	P	A	L
1/2"	15	79	49
3/4"	20	82	56
1"	25	86	68

CÓDIGO CODE	MEDIDA SIZE	PESO WEIGHT	CAJA / BOX CARTON	P.V.P. € PRICE €
3056 04	1/2"	0,180	15-120	7,13
3056 05	3/4"	0,248	12-96	9,76
3056 06	1"	0,375	6-48	15,31

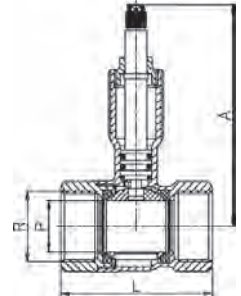

Ref. 3083



Válvula de esfera empotrar soldar

PN 16. Paso total. Construcción en latón según UNE-EN 12165. Asientos PTFE. Extremos para soldar. Temp. máx. 110°C.

Built-in ball valve - welding ends

PN 16. Full bore. Body brass UNE-EN 12165. PTFE seats. Welding ends. Max. Temp. 110°C.

D	P	A	L
15	12	78	57
18	15	79	64
22	20	82	72

3083 15	Ø15	0,149	12-144	6,96
3083 18	Ø18	0,180	8-96	7,43
3083 22	Ø22	0,245	10-80	9,51

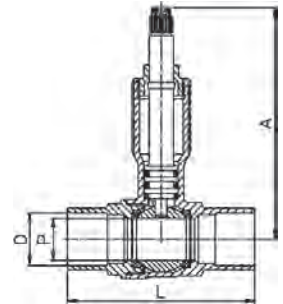

Ref. 3183



Válvulas empotrar tubería pex y multicapa con casquillos

PN 25. Paso estándar. Construcción en latón cromado según UNE-EN 12165. Asientos PTFE. Juntas casquillos de EPDM. Temp. máx. 110°C.

Built-in valve pex and multilayer pipe with sockets

PN 25. Standard bore. Body chrome plated brass UNE-EN 12165. PTFE seats. EPDM sockets joints. Max. Temp. 110°C.

ØTubo/Pipe	P	L	A
Ø16 x 2	8	72	78
Ø20 x 2	12	80	79
Ø25 x 2,5	15	96,5	82,5
Ø32 x 3	20	97,5	82,5

3183 16	Ø16 x 2	0,194	12-120	7,53
3183 20	Ø20 x 2	0,200	8-112	9,01
3183 25	Ø25 x 2,5	0,300	8-64	13,19
3183 32	Ø32 x 3	0,362	10-60	15,85

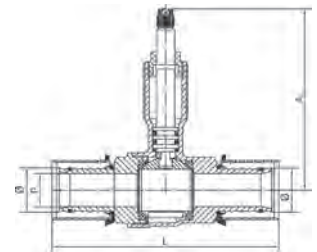

Ref. 3183B



Válvula empotrar tubería PEX-a

PN25. Paso estándar. Construcción en latón UNE-EN 12165. Asientos PTFE. Temp. máx. 110°C.

Built-in ball valve PEX-a

PN25. Standard bore. Brass construction UNE-EN 12165. PTFE seats. Max. temp. 110°C.

ØTubo/Pipe	P	L	A
Ø 16 x 1,8	10	71	79
Ø20 x 1,9	13	83	79
Ø25 x 2,3	18	101	83
Ø32 x 2,9	24	111	86

3183B 16	Ø 16 x 1,8	0,165	12-120	8,96
3183B 20	Ø20 x 1,9	0,205	8-112	9,59
3183B 25	Ø25 x 2,3	0,308	8-64	13,20
3183B 32	Ø32 x 2,9	0,396	10-60	18,90

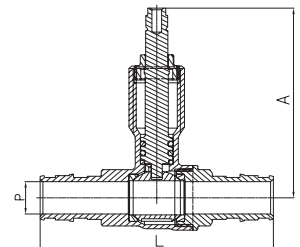

Ref. 3184

Válvula empotrar en "U" tubería pex y multicapa con casquillos

PN 25. Paso estándar. Construcción en latón cromado según UNE-EN 12165. Asientos PTFE. Juntas casquillos de EPDM. Temp. máx. 110°C.

"U" built-in ball valve pex and multilayer pipe with sockets

PN 25. Standard bore. Body chrome plated brass UNE-EN 12165. PTFE seats. EPDM sockets joints. Max.Temp. 110°C.

Ø Tubo/Pipe	L	A	B	C	D
Ø20 x 2	70	77	36	36	40
Ø25 x 2,5	87	80	46	36	50



CÓDIGO CODE	MEDIDA SIZE	PESO WEIGHT	CAJA / BOX CARTON	P.V.P. € PRICE €
-------------	-------------	-------------	-------------------	------------------

3184 20	Ø20 x 2	0,287	6-60	15,51
3184 25	Ø25 x 2,5	0,445	4-40	25,43

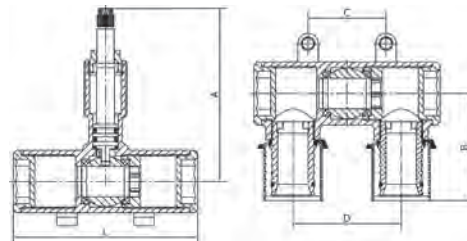

Ref. 3184B

Válvula empotrar en "U" para tubería PEX-a

PN 25. Paso estándar. Construcción en latón UNE-EN 12165. Asientos PTFE. Temp. máx. 110°C.

"U" built-in ball valve for PEX-a pipe

PN 25. Standard bore. Brass construction UNE-EN 12165. PTFE seats. Max. temp. 110°C.

ØTubo/Pipe	L	A	B	C
Ø 20 x 1,9	70	77	40,5	36
Ø 25 x 2,3	87	80	50,5	36



3184B 20	Ø 20 x 1,9	0,304	6-60	13,50
3184B 25	Ø 25 x 2,3	0,467	4-40	19,26

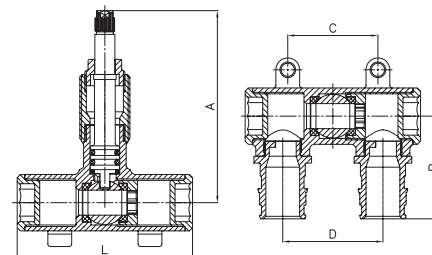

Ref. K3053

NEW

Prolongador florón para válvulas empotrar

Construcción en latón según UNE-EN 12165. Extremos roscados M-H, rosca W20 x 19h".

Cover extension for built in valves

Body brass UNE-EN 12165. Threaded ends M-F, W20 x 19h" thread.

R1	R2	L
W20 x 19h"	W20 x 19h"	23,5



K3053	-	0,016	10-1000	1,02
-------	---	-------	---------	------

Válvula no incluida / Valve not included

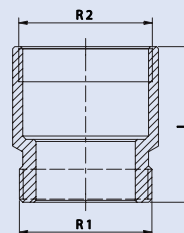

Ref. K3052P

NEW

Prolongador maneta para valvulas empotrar

Construcción en latón según UNE-EN 12165. Tornillo de fijación incluido.

Handle extension for built in valves

Body brass UNE-EN 12165. Fixing screw included

A	ØE	Z
23,5	10,5	20



K3052P	-	0,010	210-2520	2,12
--------	---	-------	----------	------

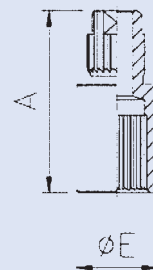

Ref. M3055



Maneta con florón

Maneta adaptable a todas las medidas de nuestras válvulas 3056, 3083, 3183, 3183B, 3184 y 3184B. Construcción de maneta y florón en zamak, acabado cromado pulido. Con refuerzo en el aro de sujeción al grafilado del eje. Incluye juego de tapones rojo y azul.

Handle with cover

Handle adaptable to all sizes of our valves 3056, 3083, 3183, 3183B, 3184 and 3184B. Zamak body, handle and cover with polished chrom-plating. Reinforced fastening ring stem. It includes blue and red plastic caps.

CÓDIGO CODE	MEDIDA SIZE	PESO WEIGHT	CAJA / BOX CARTON	P.V.P. € PRICE €
-------------	-------------	-------------	-------------------	------------------

M3055	-	-	15-180	5,20
-------	---	---	--------	------

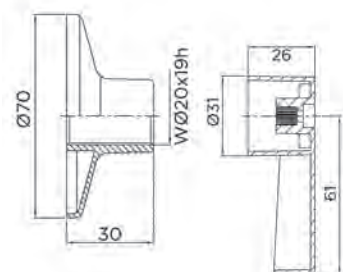

Ref. M3054



Mando oculto

Permite ocultar eje accionador de llaves de paso empotradas. Construcción de pomo en latón según UNE-EN 12165 acabado cromado pulido. Construcción de florón en zamak acabado cromado pulido.

Hidden control

Activating stem of the built-in-shut off valve can be hidden. Polished chromed brass handle UNE-EN 12165. Zamak cover, polished chromed.

M3054	-	0,1	15-180	6,13
-------	---	-----	--------	------

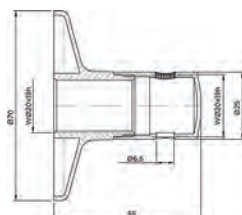

Ref. M3057



Maneta con florón

Maneta adaptable a todas las medidas de nuestras válvulas 3056, 3083, 3183, 3183B, 3184 y 3184B. Construcción de maneta y florón en zamak, acabado cromado y pulido. Con refuerzo en el aro de sujeción al grafilado del eje. Incluye juego de tapones rojo y azul.

Handle with cover

Handle adaptable to all sizes of our valves 3056, 3083, 3183, 3183B, 3184 y 3184B. Zamak handle body and cover, polished chromed. Reinforced fastening ring stem. It includes blue and red plastic caps.

M3057	-	0,13	15-180	5,44
-------	---	------	--------	------

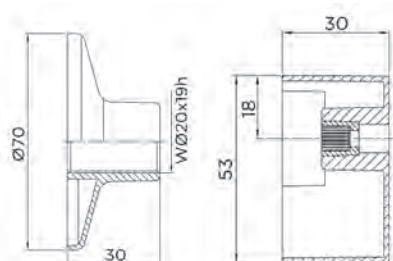

Ref. K3054

NEW

Kit mando con florón 2 piezas

Maneta adaptable a todas las medidas de nuestras válvulas 3056, 3083, 3183, 3183B, 3184 y 3184B. Construcción de maneta y florón en zamak y adaptador de latón, acabado cromado pulido. Con refuerzo en el aro de sujeción al grafilado del eje. Incluye juego de tapones rojo y azul.

Handle with 2 pieces cover kit

Available handle to all sizes of our valves 3056, 3083, 3183, 3183B, 3184 and 3184B. Zamak handle and cover, brass adapter, polished chrom-plating. Reinforced fastening ring stem. It includes blue and red plastic caps.

K3054	1/2"	0,138	15-180	7,26
-------	------	-------	--------	------

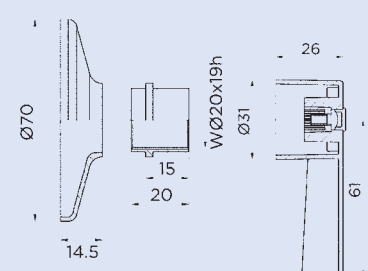

VÁLVULAS JARDÍN / BIBCOCK VALVES

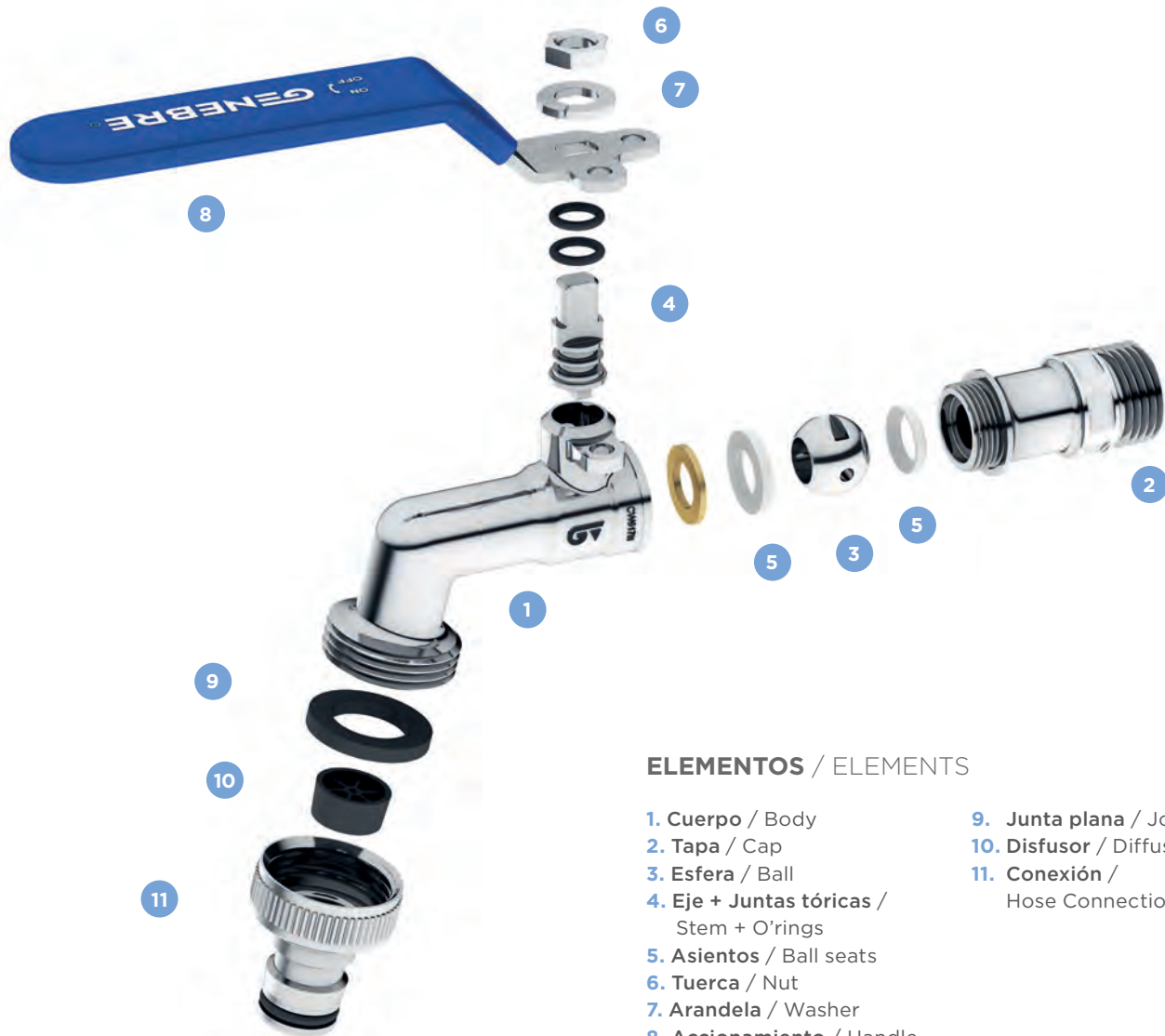

ELEMENTOS / ELEMENTS

- | | |
|---------------------------|------------------------|
| 1. Cuerpo / Body | 9. Junta plana / Joint |
| 2. Tapa / Cap | 10. Difusor / Diffuser |
| 3. Esfera / Ball | 11. Conexión / |
| 4. Eje + Juntas tóricas / | Hose Connection |
| Stem + O'rings | |
| 5. Asientos / Ball seats | |
| 6. Tuerca / Nut | |
| 7. Arandela / Washer | |
| 8. Accionamiento / Handle | |

CARACTERÍSTICAS DE LAS VÁLVULAS

- Válvulas esfera para uso ON/OFF, abierto - cerrado
- Construidas en latón UNE-EN 12165, resistente a la corrosión
- Acabado cromado, color latón y acero inoxidable
- Conexiones roscadas G ISO 228/1, enchufe rápido Rapid-Ge o manguera estándar
- Disponibles en PN16, diferentes dimensiones y pasos
- Disponibles diferentes accionamientos, palanca (acero Dacromet o inoxidable), palomilla (Aluminio), T-handle (Polímero), manetas bloqueables en posición abierta - cerrada (GELOCK SYSTEM), orificio antihielo, etc.

VALVES CHARACTERISTICS

- Ball valves for ON/OFF use, open - closed
- Construction in EN 12165 brass, corrosion resistant
- Chrome plated, brass colour or stainless Steel finished
- Threaded ends G ISO 228/1, outlet with Rapid-Ge or 2 pieces hose connection
- Available in PN16, different dimensions and bores
- Available different controls, manual lever (Dacromet Steel or Stainless Steel), butterfly (Aluminum), T-handle (Polymer), lockable controls in open - closed positions, antifreeze decompression hole, etc.



GELOCK SYSTEM

Algunas de nuestras válvulas para manguera incorporan el sistema de seguridad que permite fijar la posición deseada: **abierta - cerrada**
 Some of our bibcock ball valves, incorporate the safety system that allows you to set the desired position: **open - close**



CÓDIGO CODE	MEDIDA SIZE	PESO WEIGHT	CAJA / BOX CARTON	P.V.P. € PRICE €
----------------	----------------	----------------	----------------------	---------------------

Ref. 3059

Válvula de esfera para manguera. Paso total.

PN 16. Paso total. Construcción en latón UNE-EN 12165 cromado. Asientos PTFE. Entrada rosca gas (BSP) M - ISO 228/1. Salida racor dos piezas conexión manguera. Temp. máx. 100°C. Mando manual por palanca de acero. Precintable en posición de apertura y cierre.

Bibcock ball valve. Full bore.

PN 16. Full bore. Body chrome plated brass UNE-EN 12165. PTFE Seats. Gas threaded inlet (BSP) M - ISO 228/1. 2 pieces hose connection outlet. Max. Temp. 100°C. Steel manual control lever. Lockable in open and close position.

R	r	P	A	L	M
1/2"	3/4"	10	88	85	84
3/4"	1"	12	95	95	84
1"	1"	15	112	119	98

3059 04	1/2" x 3/4"	0,147	16-144	4,75
3059 05	3/4" x 1"	0,204	10-90	6,44
3059 06	1" x 1"	0,308	6-54	10,11

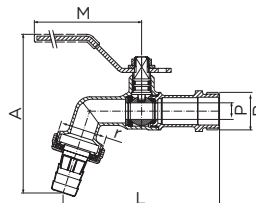

Ref. 3059L

NEW

Válvula de esfera para manguera rosca larga

PN 16. Paso total. Construcción en latón UNE-EN 12165 cromado. Asientos PTFE. Entrada roscada gas (BSP) M - ISO 228/1. Salida racor dos piezas conexión manguera. Temp. máx. 100°C. Mando manual por palanca de acero. Precintable en apertura y cierre.

Bibcock ball valve with long thread

PN 16. Full bore. Body chrome-plated brass UNE-EN 12165. PTFE seats. Gas threaded inlet (BSP) M - ISO 228/1. 2 pieces hose connection outlet. Max. temp. 100°C. Steel manual control lever. Lockable in open and close position.

R	r	P	A	L	M	B
1/2"	3/4"	10	88	97	84	19

3059L 04	1/2"	0,166	16-128	5,40
----------	------	-------	--------	------

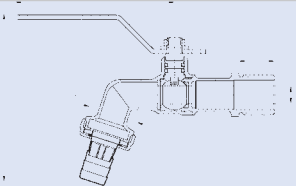

Ref. 3059R

Válvula de esfera para manguera. Paso estándar.

PN 16. Paso estándar. Construcción en latón UNE-EN 12165 cromado. Asientos PTFE. Entrada rosca gas (BSP) M - ISO 228/1. Salida racor dos piezas conexión manguera. Temp. máx. 100°C. Mando manual por palanca de acero. Precintable en posición de apertura y cierre.

Bibcock ball valve. Standard bore.

PN 16. Standard bore. Body chrome plated brass UNE-EN 12165. PTFE Seats. Gas threaded inlet (BSP) M - ISO 228/1. 2 pieces hose connection outlet. Max. Temp. 100°C. Steel manual control lever. Lockable in open and close position.

R	r	P	A	L	M
1/2"	1/2"	9,5	89	85	84
3/4"	3/4"	9,5	89	86	84

3059R 04	1/2" x 1/2"	0,159	16-192	4,89
3059R 05	3/4" x 3/4"	0,170	10-120	6,24

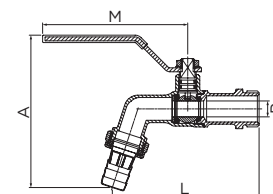

Ref. 3059D

Válvula de esfera para manguera con dos salidas

PN 16. Paso total. Construcción en latón UNE-EN 12165 cromado. Asientos PTFE. Entrada rosca gas (BSP) M - ISO 228/1. Salida racor dos piezas conexión manguera. Salida rosca macho 3/4". Temp. máx. 100°C. Mando manual por palanca de acero / aluminio. Precintable en posición de apertura y cierre.

Bibcock ball valve with two outlets

PN 16. Full bore. Body chrome plated brass UNE-EN 12165. PTFE Seats. Gas threaded inlet (BSP) M - ISO 228/1. 2 pieces hose connection outlet. 3/4" male threaded outlet. Max. Temp. 100°C. Steel / Aluminum manual control lever. Lockable in open and close position.

R	r1	r2	P	A	L	M
1/2"	3/4"	3/4"	10	88	104	84

3059D 04	1/2" x 3/4" x	0,250	8-96	8,46
05	3/4"			

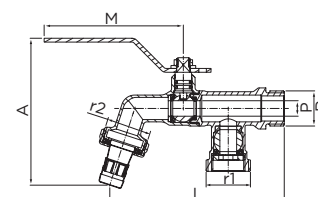

Ref. 3060



Válvula de esfera para manguera Rapid-Ge

PN 16. Paso total. Construcción en latón UNE-EN 12165 cromado. Asientos PTFE. Entrada rosca gas (BSP) M - ISO 228/1. Salida racor Rapid-Ge conexión manguera. Temp. máx. 100°C. Mando manual por palanca de acero inoxidable. Precintable en posición de apertura y cierre.

Bibcock Rapid-Ge ball valve

PN 16. Full bore. Body chrome plated brass UNE-EN 12165. PTFE Seats. Gas threaded inlet (BSP) M - ISO 228/1. Outlet with Rapid-Ge hose connection. Max. Temp. 100°C. Stainless steel lever manual control. Lockable in open and close position.

R	r	P	A	L	M
1/2"	3/4"	10	93	92	84
3/4"	1"	12	98	108	84
1"	1"	15	103	116	98

CÓDIGO CODE	MEDIDA SIZE	PESO WEIGHT	CAJA / BOX CARTON	P.V.P. € PRICE €
3060 04	1/2" x 3/4"	0,191	12-144	7,99
3060 05	3/4" x 1"	0,254	8-96	10,38
3060 06	1" x 1"	0,330	6-72	13,03

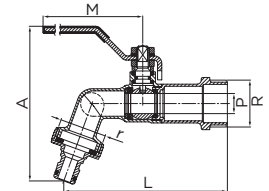

Ref. 3060F



Válvula de esfera para manguera Rapid-Ge con sistema Anti-Hielo

PN 16. Paso total. Construcción en latón UNE-EN 12165 cromado. Asientos PTFE. Entrada rosca gas (BSP) M - ISO 228/1. Salida racor Rapid-Ge conexión manguera. Temp. máx. 100°C. Mando manual por palanca de acero inoxidable. Precintable en posición de apertura y cierre. Orificio de descompresión Anti-Hielo.

Bibcock Rapid-Ge ball valve with antifreeze system

PN 16. Full bore. Body chrome plated brass UNE-EN 12165. PTFE seats. Gas threaded ends (BSP) M - ISO 228/1. Outlet with Rapid-Ge hose connection. Max. Temp. 100°C. Stainless Steel lever manual control. Lockable in open and close position. Antifreeze decompression hole.

R	r	P	A	L	M
1/2"	3/4"	10	93	92	84

3060F 04	1/2" x 3/4"	0,200	12-144	11,29
----------	-------------	-------	--------	-------

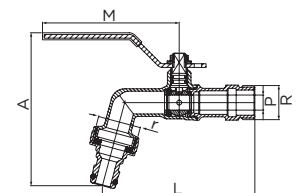

Ref. 3063



Válvula de esfera para manguera inoxidable Rapid-Ge

PN 16. Paso estándar. Construcción en acero inoxidable AISI 316. Asientos PTFE. Entrada rosca gas (BSP) M - ISO 228/1. Salida racor Rapid-Ge conexión manguera. Temp. máx. 100°C. Mando manual por palanca de acero inoxidable. Precintable en posición de cierre.

Bibcock stainless steel Rapid-Ge ball valve

PN 16. Standard bore. Stainless steel AISI 316 construction. PTFE Seats. Gas threaded inlet (BSP) M - ISO 228/1. Outlet with Rapid-Ge hose connection. Max. Temp. 100°C. Stainless steel manual control lever. Lockable in close position.

R	r	P	A	L	M
1/2"	3/4"	9,5	93	93	96

3063 04	1/2" x 3/4"	0,210	15-90	17,83
---------	-------------	-------	-------	-------

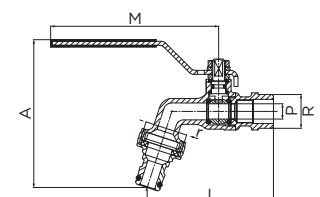

Ref. 3061



Válvulas manguera con dos salidas giratorias independientes

PN 16. Paso total. Construcción en latón UNE-EN 12165 cromado y pulido. Asientos PTFE. Entrada rosca gas (BSP) M - ISO 228/1. Temp. máx. 110°C. Una salida racor Rapid-Ge conexión manguera. Salidas giratorias 360° e independientes una de la otra. Mando palomilla de aluminio.

Bibcock valve with two independent outlet

PN 16. Full bore. Body chrome plated brass UNE-EN 12165 - chromed polished. PTFE seats. Gas threaded inlet (BSP) M - ISO 228/1. Max. Temp. 110°C. Aluminium butterfly handle. 1 Rapid-Ge outlet. Lever operated 360° outlets - independent from each other and rotatory. Aluminium butterfly handle.

r	R	L	A
1/2"	3/4"	115	65

3061 04	1/2" x 3/4"	0,378	1-60	21,41
---------	-------------	-------	------	-------

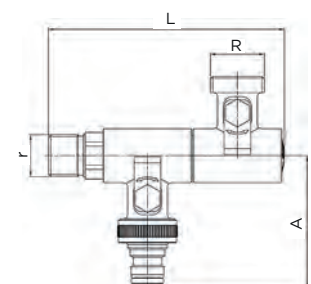

Ref. 3064



Válvula de esfera boca de riego vertical

PN 16. Paso total. Construcción en latón UNE-EN 12165. Asientos PTFE. Entrada rosca gas (BSP) M - ISO 228/1. Salida racor "Rapid-Ge" para 1/2" y 3/4" y conexión manguera en 1". Temp. máx. 100°C. Accionamiento mediante maneta T.

Vertical water hydrant ball valve

PN16. Full bore. Body brass UNE-EN 12165. PTFE Seats. Gas threaded (BSP) M - ISO 228/1. Outlet with "Rapid-Ge" for 1/2" and 3/4" and hose connection for 1". Max. Temp. 100°C. T-handle operated.

R	r	P	A	L	M
1/2"	3/4"	13	55	100	62
3/4"	1"	15	58	102	62
1"	1"	19	72	130	82

CÓDIGO CODE	MEDIDA SIZE	PESO WEIGHT	CAJA / BOX CARTON	P.V.P. € PRICE €
-------------	-------------	-------------	-------------------	------------------

3064 04	1/2" x 3/4"	0,260	12-144	11,30
3064 05	3/4" x 1"	0,292	10-120	14,08
3064 06	1" x 1"	0,450	5-60	19,73

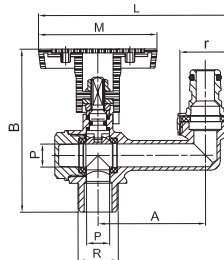

Ref. 3066



Válvula de esfera para manguera T-handle Rapid-Ge

PN 16. Paso total. Construcción en latón UNE-EN 12165 cromado. Asientos PTFE. Entrada rosca gas (BSP) M - ISO 228/1. Salida racor Rapid-Ge conexión manguera. Temp. máx. 100°C. Accionamiento mediante maneta T.

Bibcock ball T-handle valve Rapid-Ge

PN 16. Full bore. Body chrome plated brass UNE-EN 12165. PTFE Seats. Gas threaded (BSP) M - ISO 228/1. Outlet with Rapid-Ge hose connection. Max. Temp. 100°C. T-handle operated.

R	r	P	A	L	M
1/2"	3/4"	10	98	86	62
3/4"	1"	12	104	96	62

3066 04	1/2" x 3/4"	0,169	12-144	8,66
3066 05	3/4" x 1"	0,225	10-120	11,06

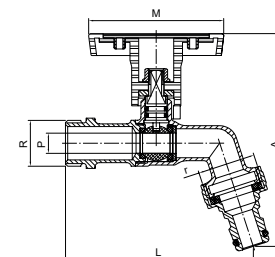

Ref. 3066B



Válvula de esfera para manguera

PN 16. Paso total. Construcción en latón UNE-EN 12165 cromado. Asientos PTFE. Entrada rosca gas (BSP) M - ISO 228/1. Salida racor dos piezas conexión manguera. Temp. máx. 100°C. Mando manual por palomilla de aluminio.

Bibcock ball valve

PN 16. Full bore. Body chrome plated brass UNE-EN 12165. PTFE Seats. Gas threaded inlet (BSP) M - ISO 228/1. 2 pieces hose connection outlet. Max. Temp. 100°C. Aluminium butterfly manual control.

R	r	P	A	L	M
1/2"	3/4"	10	82	85	50
3/4"	1"	12	88	95	50

3066B 04	1/2" x 3/4"	0,134	15-180	5,02
3066B 05	3/4" x 1"	0,190	8-96	6,76

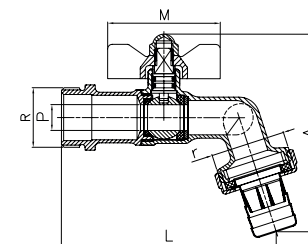

Ref. 3367



Válvula de esfera para manguera

PN 16. Construcción en latón UNE-EN 12165 acabado cromado pulido. Asientos PTFE. Entrada rosca gas (BSP) M ISO 228/1. Salida racor dos piezas conexión manguera. Salida rosca macho 3/4". Temp. máx. 100°C. Mando palanca ZAMAK.

Bibcock ball valve

PN16. Body polished chrome plated brass UNE-EN 12165. PTFE Seats. Male gas threaded end (BSP) ISO 228/1. 2 pieces hose connection outlet. 3/4" male threaded outlet. Max. temp. 100°C. ZAMAK lever control.

R	r	A	L	M
1/2"	3/4"	58	62	37

3367 04	1/2" x 3/4"	0,160	10-90	6,92
---------	-------------	-------	-------	------

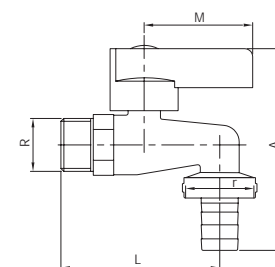

Ref. 3065

"Caja jardín" Válvula de esfera boca de riego vertical con caja y tapa

Válvula de esfera boca de riego vertical ref. 3064 y arqueta de plástico con tapa color verde. Mando con la máxima altura para facilitar la apertura y cierre de la válvula con conexión Rapid-Ge.

"Garden box" water hydrant ball valve with cover

Vertical water hydrant ball valve ref. 3064 and plastic box with green cover. Maximum height control to facilitate opening and closing of the valve Rapid-Ge connector.



A	Ø L	B
102	190	124

CÓDIGO CODE	MEDIDA SIZE	PESO WEIGHT	CAJA / BOX CARTON	P.V.P. € PRICE €
----------------	----------------	----------------	----------------------	---------------------

3065 04	1/2" x 3/4"	0,950	1-12	40,64
3065 05	3/4" x 1"	0,950	1-12	44,13

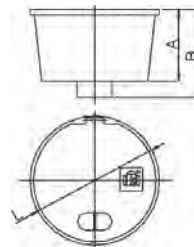

Ref. 3217

Conexión de manguera "Turbojet"

Conexión rosca tuerca loca hembra 3/4" ISO 228/1. Accionamiento manual por palanca de acero. Alta presión. Incluye 2 boquillas: función chorro y función lluvia. Longitud total 76 cm.

"Turbojet" hose connection

Connection thread female free nut 3/4" ISO 228/1. Steel manual control lever. High pressure. Includes 2 nozzles: stream and rain function. Total length 76 cm.

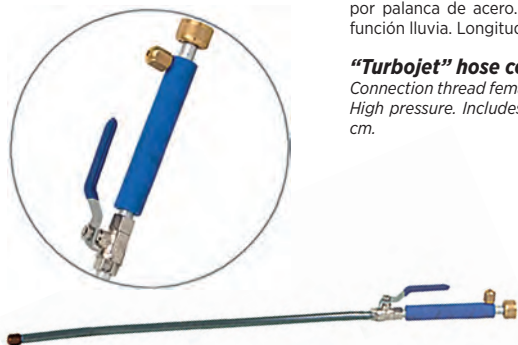

3217 00	3/4"	0,400	1-6	21,53
---------	------	-------	-----	-------

Precio unitario / Unit price

Ref. R360

Racor manguera convencional

Adaptable a toda la serie de grifos manguera. Construcción en acero inox y latón según UNE-EN 12165. Acabado cromo pulido. Equipado con difusor de plástico para optimizar la homogeneidad del fluido.

Conventional hose connector

Adaptable to all kind of hose taps. Built in stainless steel and brass according to UNE-EN 12165. Polished chrome-plated finishing. Equipped with plastic diffuser to optimize the homogeneity of the fluid.



r	D	A
3/4"	15	31
1"	20,5	33
1"	26,5	42

R360 04	3/4" x 15	0,035	50-600	1,56
R360 05	1" x 20,5	0,019	50-600	1,89
R360 06	1" x 26,5	0,042	25-300	3,35

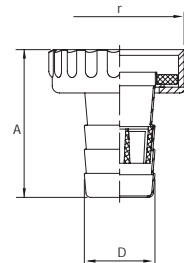

Ref. 3211

Racor hembra rapid-Ge cromado

Sistema de anclaje adaptable a enchufe 3215. Construcción en latón según UNE-EN 12165 acabado cromado pulido.

Rapid-Ge quick female connector

Anchoring system adaptable to switch 3215. Body chrome plated brass UNE-EN 12165 - polished.



R	P	A	L
3/4"	9,5	34	28,5
1"	9,5	34	35,7

3211 05	3/4"	0,035	40-800	1,95
3211 06	1"	0,048	30-360	2,70

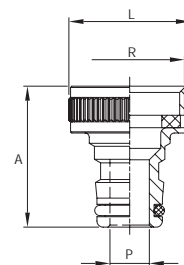

Ref. 3215



Enchufe manguera Rapid-Ge

Sistema convencional de anclaje adaptable a racor 3211. Construcción en latón según UNE-EN 12165.

Quick rapid-ge hose switch

Conventional anchoring system adaptable to connector 3211. Body brass UNE-EN 12165.

Ø A	L	Ø max. Tubo
29	44	18
36	50	26

CÓDIGO CODE	MEDIDA SIZE	PESO WEIGHT	CAJA / BOX CARTON	P.V.P. € PRICE €
-------------	-------------	-------------	-------------------	------------------

3215 05	Ø18	0,070	20-240	6,54
3215 06	Ø26	0,140	20-240	7,93

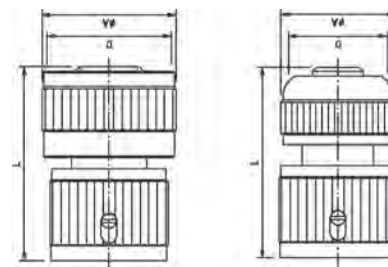

Ref. 3068



Válvula de esfera barril de latón

PN 16. Paso estándar. Construcción en latón UNE-EN 12165 acabado pulido cromado. Asientos PTFE. Entrada rosca gas (BSP) macho - ISO 228/1. Temp. máx. 110°C. Mando manual por palomilla de aluminio.

Brass barrel ball valve

PN 16. Standard bore. Body chrome plated brass UNE-EN 12165 - polished. PTFE seats. Male gas threaded (BSP) inlet - ISO 228/1. Max. temp. 110°C. Aluminium butterfly handle.

R	DN	P	A	L	M
1/2"	7,5	9,5	75	77	50
3/4"	8,5	11,5	84	90	50

3068 04	1/2"	0,121	12-216	7,17
3068 05	3/4"	0,180	8-144	8,98

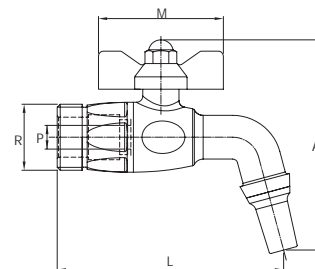

Ref. 2918



Válvula de esfera para barril de acero inoxidable

PN 16. Paso red. Construcción en acero inox - AISI 316. Asientos PTFE. Entrada rosca gas (BSP) macho según ISO 228/1. Temp. máx. 110°C. Accionamiento mediante palomilla de acero inoxidable.

Stainless steel barrel ball valve

PN 16. Reduced bore. Body stainless steel AISI 316. PTFE seats. Male gas threaded (BSP) inlet ISO 228/1. Max. temp. 110°C. Stainless steel butterfly handle operated.

R	A	L	M
3/8"	34	85	50
1/2"	34	85	50
3/4"	43	106	63

2918 03	3/8"	0,194	10-140	22,50
2918 04	1/2"	0,160	8-112	22,50
2918 05	3/4"	0,351	4-56	33,77

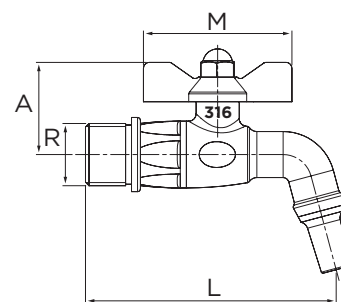

Ref. 2919



Válvula de esfera para barril de acero inoxidable

PN 16. Paso red. Construcción en acero inox - AISI 316. Entrada rosca cónica macho. Temp. máx. 110°C. Accionamiento mediante palomilla de acero inoxidable.

Stainless steel barrel ball valve

PN 16. Reduced bore. Body stainless steel AISI 316. Male threaded conical inlet. Max. temp. 110°C. Stainless steel butterfly handle operated.

MED.	D	A	L	M
1/2"	18	34	85	50
3/4"	26	43	106	63

2919 04	1/2"	0,180	8-64	23,62
2919 05	3/4"	0,400	4-56	35,47

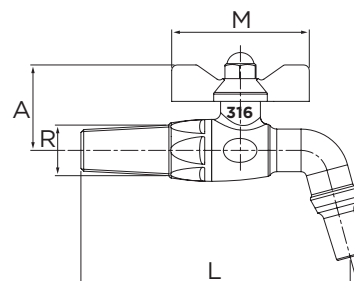

VÁLVULAS ESCUADRA / ANGLE VALVES

ELEMENTOS / ELEMENTS

1. Cuerpo / Body
2. Obturador / Shutter
3. Juntas tóricas / O'rings
4. Florón / Cover
5. Tornillo / Screw
6. Maneta / Handle
7. Anillo PTFE / PTFE ring
8. Junta plana + anillo / Joint + ring



CARACTERÍSTICAS DE LAS VÁLVULAS

- Válvulas para uso ON/OFF, abierto o cerrado. Uso doméstico
- Construidas en latón UNE-EN 12165, resistente a la corrosión
- Acabado cromado + pulido
- Conexiones roscadas Macho - Hembra G ISO 228/1 y NPT
- Disponibles en PN10 y PN16
- Disponibles en diferentes dimensiones y pasos
- Accionamiento 1/4 vuelta, manetas con distintos diseños

VALVES CHARACTERISTICS

- Ball valves for ON/OFF use, open - closed. Domestic use
- Construction in EN 12165 brass, corrosion resistant
- Chrome plated + polished finished
- Threaded ends Male - Female G ISO 228/1 and NPT
- Available in PN10 and PN16
- Available different dimensions and bores
- 1/4 turn handle, several designs handles

Ref. 3094



Válvula escuadra "Isis"

PN 10. Paso estándar. Construcción en latón cromado según UNE-EN 12165. Extremos rosca gas (BSP) M-M según ISO 228/1. Temp. máx. 110°C. Mando ABS 1/4 de vuelta. Cierre mediante eje excéntrico (Sistema Genebre).

"Isis" angle valve

PN 10. Standard bore. Made in chromed brass according to UNE-EN 12165. Gas threaded ends (BSP) M-M ISO 228/1. Max. Temp. 110°C. ABS 1/4 turn handle. Eccentric stem closing system (Genebre system).

R	r	P	L	D
1/2"	3/8"	6	83	50
1/2"	1/2"	6	83	50

CÓDIGO CODE	MEDIDA SIZE	PESO WEIGHT	CAJA / BOX CARTON	P.V.P. € PRICE €
-------------	-------------	-------------	-------------------	------------------

3094 04	1/2" x 3/8"	0,074	2-240	3,35
3094 05	1/2" x 1/2"	0,077	2-240	3,54

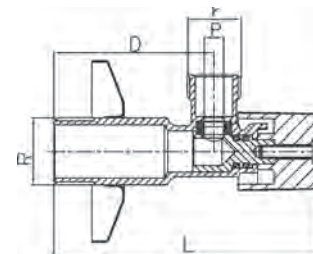

Ref. 3094P

NEW



Válvula escuadra con anillo PTFE montaje rápido

PN 10. Paso estándar. Construcción en latón UNE-EN 12165 acabado cromado pulido. Extremos rosca gas (BSP) M - M según ISO 228/1. Temp. máx. 110°C. Mando ABS 1/4 de vuelta. Cierre mediante eje excéntrico (sistema Genebre).

Angle valve with PTFE ring to quick assembly

PN 10. Standard bore. Body chrome plated brass UNE-EN 12165. Gas threaded ends (BSP) M-M, ISO 228/1. Max. temp. 110°C. ABS 1/4 turn handle. Eccentric stem closing system (Genebre system).

R	r	P	L	D
1/2"	3/8"	6	88	55
1/2"	1/2"	6	88	55

3094P 04 03	1/2" x 3/8"	0,087	2-200	4,04
-------------	-------------	-------	-------	-------------

3094P 04 04	1/2" x 1/2"	0,091	2-200	4,19
-------------	-------------	-------	-------	-------------

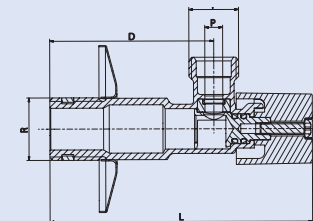

Ref. 3094E

Válvula escuadra económica

PN 10. Paso estándar. Construcción en latón cromado según UNE-EN 12165. Extremos rosca gas (BSP) M-M según ISO 228/1. Temp. máx. 110°C. Mando ABS 1/4 de vuelta. Cierre mediante eje excéntrico (Sistema Genebre).

Economic angle valve

PN 10. Standard bore. Made in chromed brass according to UNE-EN 12165. Gas threaded ends (BSP) M-M ISO 228/1. Max. Temp. 110°C. ABS 1/4 turn handle. Eccentric stem closing system (Genebre system).

R	r	P	L	D
1/2"	3/8"	6	78	45
1/2"	1/2"	6	78	45

3094E 04	1/2" x 3/8"	0,079	2-240	2,81
----------	-------------	-------	-------	-------------

3094E 05	1/2" x 1/2"	0,083	2-240	2,98
----------	-------------	-------	-------	-------------

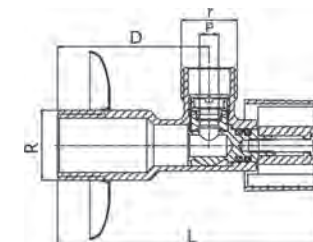

Ref. 3294

Válvula escuadra alargada

PN 10. Paso estándar. Construcción en latón cromado según UNE-EN 12165. Extremos rosca gas (BSP) M-M según ISO 228/1. Temp. máx. 110°C. Mando ABS 1/4 de vuelta. Cierre mediante eje excéntrico (Sistema Genebre).

Long angle valve

PN 10. Standard bore. Made in chromed brass according to UNE-EN 12165. Gas threaded ends (BSP) M-M ISO 228/1. Max. Temp. 110°C. ABS 1/4 turn handle. Eccentric stem closing system (Genebre system).

R	r	P	L	D
1/2"	3/8"	6	95	62
1/2"	1/2"	6	95	62

3294 04	1/2" x 3/8"	0,094	2-200	4,37
---------	-------------	-------	-------	-------------

3294 05	1/2" x 1/2"	0,098	2-200	4,52
---------	-------------	-------	-------	-------------

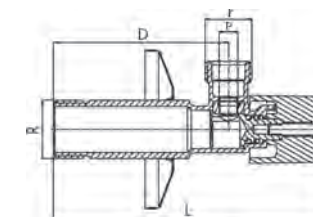

Ref. 3104



Válvula escuadra redonda "Tau"

PN 10. Construcción de cuerpo y florón en latón según UNE-EN 12165. Cromado según EN 248. Extremos roscados gas (BSP) M-M según ISO 228/1. Apertura y cierre por montura cerámica. Temp.máx. 85°C.

Round angle valve "Tau"

PN 10. Body and cover made in brass according to UNE-EN 12165. Chrome plated according to EN 248. Gas threaded ends (BSP) M-M ISO 228/1. Opening and closing operation by ceramic headwork. Max.temp. 85°C.

R	r	P	L	D
1/2"	3/8"	10	81	41
1/2"	1/2"	10	81	41

CÓDIGO CODE	MEDIDA SIZE	PESO WEIGHT	CAJA / BOX CARTON	P.V.P. € PRICE €
-------------	-------------	-------------	-------------------	------------------

3104 04	1/2" x 3/8"	0,145	2-120	7,65
3104 05	1/2" x 1/2"	0,140	2-120	9,99

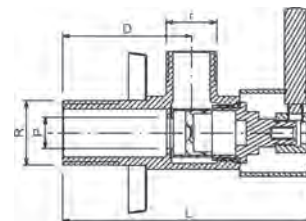

Ref. 3106



Válvula escuadra cuadrada "Cubik"

PN 10. Construcción de cuerpo y florón en latón según UNE-EN 12165. Cromado según EN 248. Extremos roscados gas (BSP) M-M según ISO 228/1. Apertura y cierre por montura cerámica. Temp.máx. 85°C.

Square angle valve "Cubik"

PN 10. Body and cover made in brass according to UNE-EN 12165. Chrome plated according to EN 248. Gas threaded ends (BSP) M-M ISO 228/1. Opening and closing operation by ceramic headwork. Max.temp. 85°C.

R	r	P	L	D
1/2"	3/8"	10	74	35
1/2"	1/2"	10	74	35

3106 04	1/2" x 3/8"	0,193	2-120	10,17
3106 05	1/2" x 1/2"	0,193	2-120	12,54

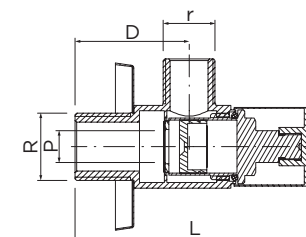

Ref. 3109



Válvula manguera con dos salidas independientes

PN 10. Construcción en latón según UNE-EN 12165 cromado y pulido. Extremos roscados gas (BSP) M-M según ISO 228/1. Apertura y cierre por montura cerámica. Temp. máx. 85°C.

Bibcock valve with two independent outlets

PN 10. Made in brass according to UNE-EN 12165 chrome-plated and polished. Gas threaded ends (BSP) M-M ISO 228/1. Opening and closing operation by ceramic headwork. Max. temp. 85°C.

R	r1	r2	L	A	B
1/2"	3/8"	1/2"	114	26	39

3109 04	1/2" x 3/8" x 1/2"	0,262	1-90	13,37
---------	--------------------	-------	------	-------

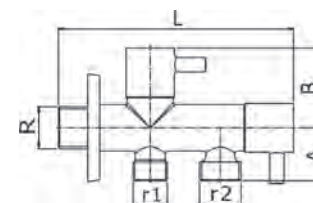

Ref. 3062



Válvulas manguera con dos salidas independientes sin racor

PN 16. Paso estándar. Construcción en latón UNE-EN 12165 cromado y pulido. Mandos en ABS 1/4 vuelta. Asientos PTFE. Cierre central eje excéntrico (sistema Genebre) y cierre lateral mediante esfera. Extremos roscados gas (BSP) M ISO 228/1. Temp. máx. 110°C.

Bibcock valve with two independent outlet without hose connection

PN 16. Standard bore. Forged brass body UNE-EN 12165 chromed polished. ABS 1/4 turn handles. PTFE seats. Eccentric stem central closing (system Genebre) and ball lateral closing. Gas threaded ends (BSP) M ISO 228/1. Max. temp. 110°C.

R	r1	r2
1/2"	1/2"	3/8"
1/2"	1/2"	1/2"
1/2"	3/4"	3/8"
1/2"	3/4"	1/2"
1/2"	3/4"	3/4"

3062 04 03	1/2" x 1/2" x 3/8"	0,152	1-144	12,73
3062 04 04	1/2" x 1/2" x 1/2"	0,153	1-144	12,73
3062 05 03	1/2" x 3/4" x 3/8"	0,160	1-144	12,73
3062 05 04	1/2" x 3/4" x 1/2"	0,166	1-144	12,79
3062 05 05	1/2" x 3/4" x 3/4"	0,160	1-144	12,79

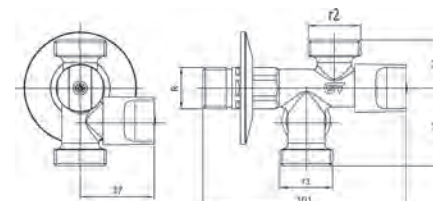

Ref. 3095



Válvula de escuadra con filtro

PN 10. Paso estándar. Construcción en latón según UNE-EN 12165 acabado cromado pulido. Extremos roscados macho según ISO 228/1. Temp. máx. 110°C. Filtro inox.

Angle valve with strainer

PN 10. Standard bore. Chrome plated brass body UNE-EN 12165 - polished. Male threaded ends (BSP) DIN 228/1. Max. temp. 110°C. Stainless steel strainer.

R	r	P	A	L
1/2"	3/8"	8	50	59
1/2"	1/2"	8	50	59
1/2"	3/4"	8	54	63

CÓDIGO CODE	MEDIDA SIZE	PESO WEIGHT	CAJA / BOX CARTON	P.V.P. € PRICE €
3095 03	1/2" x 3/8"	0,090	10-240	4,07
3095 04	1/2" x 1/2"	0,095	10-240	4,26
3095 05	1/2" x 3/4"	0,106	10-240	5,09

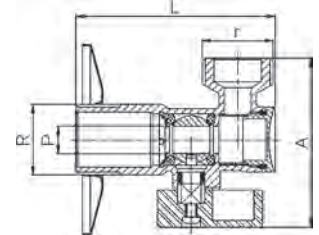

Ref. 3095N



Válvula de escuadra con filtro - rosca NPT

PN 10. Paso estándar. Construcción en latón según UNE-EN 12165. Acabado cromado pulido. Extremos roscados macho NPT según ANSI B 1.20.1 y UNEF 9/16 según ASME B 1.1. Temp. máx. 110°C. Filtro inox.

Angle valve with strainer - NPT thread

PN 10. Standard bore. Brass construction according UNE-EN 12165. Polished chrome plated. Male thread ends NPT according to ANSI B 1.20.1 and UNEF 9/16 according to ASME B 1.1. Máx. temp. 110°C. Stainless steel strainer.

R	r	P	A	L
1/2"	UNEF 9/16 24H	8	50	59

3095N 04	1/2" NPT x UNEF 9/16 24H	0,080	10-240	4,20
----------	--------------------------	-------	--------	-------------

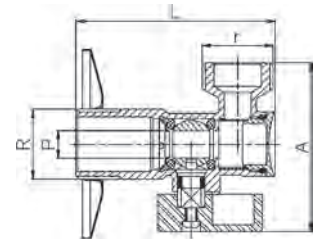

Ref. 3195N



Válvula de escuadra con filtro - rosca NPT

PN 10. Paso estándar. Construcción en latón según UNE-EN 12165. Acabado cromado pulido. Extremos roscados hembra NPT según ANSI B 1.20.1 y macho según ASME B 1.1 o según ISO 228/1. Temp. máx. 110°C. Filtro inox.

Angle valve with strainer - NPT thread

PN 10. Standard bore. Brass construction according UNE-EN 12165. Polished chrome plated. Female NPT thread end according to ANSI B 1.20.1 and male according to ASME B 1.1 or according to ISO 228/1. Max. temp. 110°C. Stainless steel strainer.

R	r	P	A	L
1/2" NPT	G3/8"	8	50	59
1/2" NPT	UNEF 9/16 24H	8	50	59

3195N 03	1/2" NPT x G3/8"	0,090	10-240	4,32
3195N 04	1/2" NPT x UNEF 9/16 24H	0,095	10-240	4,32

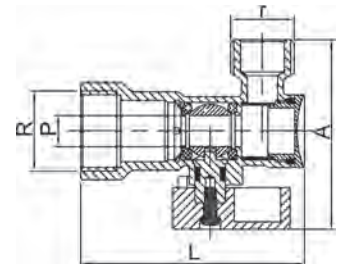

Ref. 3196N



Válvula de escuadra con filtro-rosca NPT

PN10. Paso estándar. Construcción el latón según UNE-EN 12165. Acabado cromado pulido. Extremos rosca hembra NPT según ANSI B 1.20.1 y macho gas (BSP), ISO 228/1. Temperatura máxima 110°C. Filtro acero inoxidable.

Angle valve with strainer- NPT thread

PN10. Standard bore. Brass construction according UNE-EN 12165. Polished chrome plated. Female NPT thread according ANSI B 1.20.1 and male Gas threaded (BSP), ISO 228/1. Maximum temperature 110°C. Stainless steel strainer.

R	r	P	A	L	M
1/2" NPT	G1/2"	8	50	59	31

3196N 04	1/2" NPT x G1/2"	0,104	10-240	4,56
----------	------------------	-------	--------	-------------

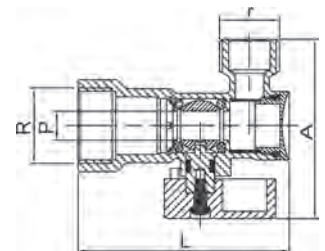

Ref. 3090



Válvula escuadra lavadora

PN 10. Paso estándar. Construcción en latón según UNE-EN 12165 cromado. Asientos NBR. Extremos rosca gas (BSP) M-M ISO 228/1. Temp. máx. 110°C. Mando manual por palomilla ABS.

Washing machine angle valve

PN 10. Standard bore. Body brass UNE-EN 12165. NBR seats - M-M gas threaded ends (BSP) ISO 228/1. Max. temp. 110°C. ABS butterfly handle operated.

r	R	P	A	L	M
1/2"	3/4"	9	65	49	39

CÓDIGO CODE	MEDIDA SIZE	PESO WEIGHT	CAJA / BOX CARTON	P.V.P. € PRICE €
3090 04	1/2" x 3/4"	0,110	10-180	5,01

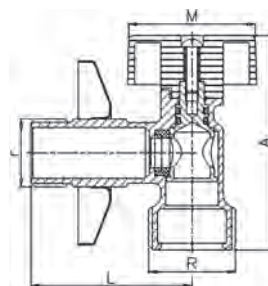

Ref. 3392



Válvula lavadora simple cromada modelo "TEK"

PN16. Paso estandar. Construcción en latón UNE-EN 12165 acabado cromado pulido. Extremos roscados rosca gas (BSP) M ISO 228/1. Temp. máx. 100°C. Accionamiento mediante volante.

"TEK" chrome-plated simple washing machine valve

PN16. Standard bore. Body polished chrome plated brass UNE-EN 12165. Male gas threaded end (BSP) ISO 228/1. Max. temp. 100°C. Hand wheel operated.

R	r	A	L	M
1/2"	3/4"	24,5	51	32

3392 04	1/2" x 3/4"	0,194	10-90	8,18
---------	-------------	-------	-------	------

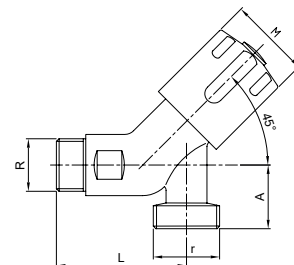

Ref. 3091



Válvula de esfera escuadra lavadora

PN 16. Paso estándar. Construcción en latón según UNE-EN 12165 cromado. Asientos PTFE. Extremos rosca gas (BSP) M-M ISO 228/1. Temp. máx. 110°C. Mando ABS 1/4 de vuelta.

Washing machine angle valve

PN 16. Standard bore. Body brass according UNE-EN 12165 chrome plated. PTFE seats. Gas threaded ends (BSP) M-M ISO 228/1. Max. temp. 110°C. ABS 1/4 turn handle.

R	r	A	L	M
1/2"	3/4"	75	48	34

3091 04	1/2" x 3/4"	0,155	10-180	6,05
---------	-------------	-------	--------	------

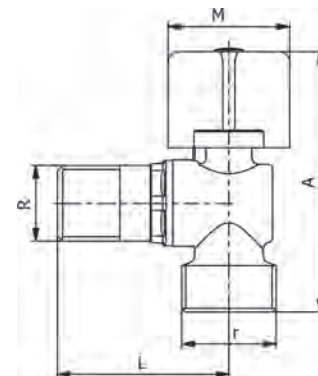

Ref. 3092



Válvula mixta lavadora - lavabo

PN 16. Paso total. Construcción en latón según UNE-EN 12165. Acabado cromado pulido. Extremos roscados gas (BSP) según ISO 228/1 - accionamiento mediante volante. Temp. máx. 110°C.

Washing machine - washbasin mixed valve

PN 16. Full bore. Chrome plated brass body UNE-EN 12165 - polished. Gas threaded ends (BSP) ISO 228/1. Hand wheel operated. Max. temp. 110°C.

R1	R2	r	A	L
1/2"	3/4"	3/8"	80,5	115

3092 04	1/2" x 3/4" x 3/8"	0,260	1-80	10,97
---------	--------------------	-------	------	-------

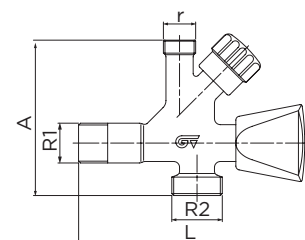

VÁLVULAS RETENCIÓN / CHECK VALVES

ELEMENTOS / ELEMENTS

1. Cuerpo / Body
2. Obturador / Shutter
3. Muelle / Spring
4. Soporte / Support



CARACTERÍSTICAS DE LAS VÁLVULAS

- Evitan el retorno del fluido. Tipo disco o clapeta
- Construidas en latón UNE-EN 12165 o Bronce EN 1982, resistente a la corrosión
- Acabado cromado + pulido, latón o bronce
- Conexiones roscadas G ISO 228/1, NPT y para tubo PE
- Disponibles de PN8 a PN16
- Disponibles diferentes dimensiones y pasos
- Válvulas de pie con filtro, filtro como accesorio
- Cierre mediante disco vulcanizado NBR o disco de metal

VALVES CHARACTERISTICS

- Prevent fluid return, disc or swing type
- Construction in EN 12165 brass or EN 1982 bronze, corrosion resistant
- Finished Chrome plated + polished, brass or bronze colour
- Threaded ends G ISO 228/1, NPT or PE pipe
- Available from PN8 to PN16
- Available several dimensions and bores
- Check valve with filter
- Closure by vulcanized disc NBR or metal disc

Ref. 3121 - 3121N



Válvula de retención "REGÉ"

PN 25/12. Construcción en latón UNE-EN 12165. Junta de clapeta vulcanizada de NBR. Muelle en acero inox. AISI 304. Extremos rosca gas (BSP) H-H - ISO 228/1. Temp. máx. 90°C. Montaje en cualquier posición.

También disponible con rosca NPT (3121N).

REGÉ check valve

PN 25/12. Body brass UNE-EN 12165. Vulcanized NBR gasket plate. Stainless steel spring AISI 304. Gas threaded ends (BSP) F-F ISO 228/1. Max. temp. 90°C. Multipositional setting up.

Also available NPT thread (3121N).

R	PN	D	A
1/2"	25	30	50
3/4"	25	37	57
1"	25	43	65
1 1/4"	18	53	70
1 1/2"	18	65	76
2"	18	80	82
2 1/2"	12	104	104
3"	12	124	113
4"	12	155	132

CÓDIGO CODE	MEDIDA SIZE	PESO WEIGHT	CAJA / BOX CARTON	P.V.P. € PRICE €
3121 04	1/2"	0,101	30-270	4,25
3121 05	3/4"	0,164	24-192	6,17
3121 06	1"	0,259	12-96	9,16
3121 07	1 1/4"	0,361	10-60	12,64
3121 08	1 1/2"	0,513	5-40	17,96
3121 09	2"	0,795	2-16	26,82
3121 10	2 1/2"	1,536	1-15	59,70
3121 11	3"	2,349	1-12	85,41
3121 12	4"	3,707	1-5	135,89

Precios rosca NPT a consultar / NPT thread prices on request

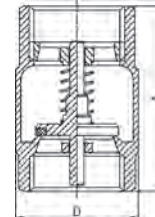

Ref. 3122P - 3122PN



Válvula de retención "REGÉ PLUS"

PN 25/18. Construcción en latón cromado según UNE-EN 12165. Cierre NBR vulcanizado. Muelle acero inox. AISI 304. Extremos rosca gas (BSP) H-H según ISO 228/1. Temp. máx. 90°C. Montaje en cualquier posición.

"REGÉ PLUS" check valve

PN 25/18. Made in chrome-plated brass according to UNE-EN 12165. Vulcanized NBR sealing. Stainless steel AISI 304 spring. Gas threaded ends (BSP) F-F ISO 228/1. Max. temp. 90°C. Install in any position.

R	PN	D	A
1/2"	25	28	57
3/4"	25	35	64
1"	25	42	75
1 1/4"	18	52	82
1 1/2"	18	63	93
2"	18	78	100

CÓDIGO CODE	MEDIDA SIZE	PESO WEIGHT	CAJA / BOX CARTON	P.V.P. € PRICE €
3122P 04	1/2"	0,110	30-240	6,03
3122P 05	3/4"	0,190	24-96	8,54
3122P 06	1"	0,305	12-96	12,84
3122P 07	1 1/4"	0,436	8-48	18,75
3122P 08	1 1/2"	0,657	6-36	29,32
3122P 09	2"	0,965	2-16	44,20

Precios rosca NPT a consultar / NPT thread prices on request

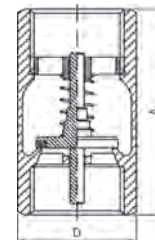

Ref. 3142

NEW



Válvula retención con filtro

PN 10. Construcción en latón UNE-EN 12165. Extremos roscados (BSP) H - ISO 228/1. Temperatura máxima de trabajo 90°C. Cierre de NBR vulcanizado. Muelle i tamiz de acero inox AISI 304. Presión mínima apertura 20 - 60 mbar.

Check valve with filter

PN 10. Body brass UNE-EN 12165. Gas threaded ends ISO 228/1 - F. Max. temp. 90°C. Vulcanized NBR sealing. Stainless steel spring and sleeve AISI 304. Minimum working pressure 20 - 60 mbar.

R	PN	D	A
1/2"	10	31	79
3/4"	10	34,5	85,5
1"	10	42	99
1 1/4"	10	48,6	102,5
1 1/2"	10	59,5	121
2	10	68,5	137

CÓDIGO CODE	MEDIDA SIZE	PESO WEIGHT	CAJA / BOX CARTON	P.V.P. € PRICE €
3142 04	1/2"	0,08	12-216	4,31
3142 05	3/4"	0,123	8-112	5,85
3142 06	1"	0,169	6-60	7,81
3142 07	1 1/4"	0,244	-	10,12
3142 08	1 1/2"	0,346	-	14,13
3142 09	2"	0,484	-	19,85

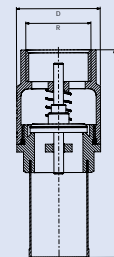

Ref. 3123



Válvula esfera con retención

Válvula esfera con retención PN 25. Paso total. Construcción en latón UNE-EN 12165 cromado. Asientos PTFE. Extremos roscados H-H ISO 228/1. Temp. máx. 90°C. Accionamiento esfera palomilla. Cierre retención NBR vulcanizado. Muelle acero inox AISI 304. Presión mínima trabajo 0,03 bar.

Ball valve with check valve

PN 25. Full bore. Body chrome plated brass UNE-EN 12165. PTFE seats. Threaded ends F-F ISO 228/1. Max. temp. 90°C. Ball working butterfly handle. Vulcanized NBR check valve sealing. Stainless steel spring AISI 304. Minimum working pressure 0 - 03 bar.

R	P	A	L	M
1/2"	15	76	50	50
3/4"	20	91	62	62
1"	25	106	69	62

CÓDIGO CODE	MEDIDA SIZE	PESO WEIGHT	CAJA / BOX CARTON	P.V.P. € PRICE €
3123 04	1/2"	0,190	10-160	8,06
3123 05	3/4"	0,360	6-60	13,66
3123 06	1"	0,519	4-40	22,07

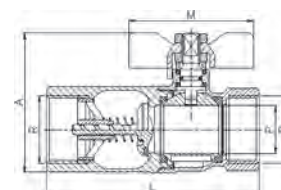

Ref. 3124



Racor acoplamiento recto con válvula de retención

PN 16. Construcción en latón forjado según UNE-EN 12165. Conexión a tubería mediante sistema de apriete diseño Genebre "RAC-GE". Temperatura de trabajo de -10°C a 90°C. Aplicable para la unión con tubo de polietileno en baja media y alta densidad. Cierre NBR vulcanizado. Muelle acero inox. AISI 304. Montaje en cualquier posición.

Straight coupling connector with check valve

PN 16. Forged brass according to UNE-EN 12165. Genebre's designed "RAC-GE" air tight system for connection to pipe. Working temp. -10°C to 90°C. Applicable for the connection of low, medium and high density polyethylene pipe. Vulcanized NBR sealing. Stainless steel AISI 304 spring. Install in any position.

PE	P	Ø D	A
PE25 x PE25	20	41	85
PE32xPE32	25	50	100
PE40 x PE40	32	60	120

CÓDIGO CODE	MEDIDA SIZE	PESO WEIGHT	CAJA / BOX CARTON	P.V.P. € PRICE €
3124 05	25x25	0,277	18-72	12,00
3124 06	32x32	0,446	10-40	19,51
3124 07	40x40	0,692	8-32	30,79

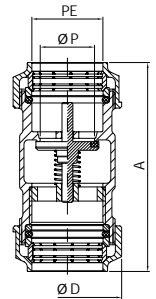

Ref. 3120



Válvula de retención "York"

PN 12 - PN 10 - PN 8. Construcción en latón UNE-EN 12165. Obturador de disco en poliamida 6. Cierre en NBR (goma) 65 sh. Muelle en acero inox. AISI 302. Extremos rosca gas (BSP) H-H - ISO 228/1. Temp. máx. 100°C. Montaje en cualquier posición.

"York" check valve

PN 12 - PN 10 - PN 8. Body brass UNE-EN 12165. NBR (rubber) sealing 65 sh/ps. Stainless steel spring - AISI 302. Gas threaded ends (BSP) F-F ISO 228/1. Max. temp. 100°C. Assembling: any position.

R	PN	P	B	A
3/8"	12	10	34	46
1/2"	12	15	34	47
3/4"	12	20	42	52
1"	12	25	48	60
1 1/4"	10	32	59	66
1 1/2"	10	40	70	73
2"	10	50	86	79
2 1/2"	8	65	102	97
3"	8	80	125	103
4"	8	100	153	119

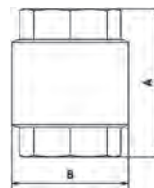

3120 03	3/8"	0,125	10-200	5,32
3120 04	1/2"	0,140	10-200	5,41
3120 05	3/4"	0,206	8-128	8,35
3120 06	1"	0,277	8-88	9,94
3120 07	1 1/4"	0,390	6-54	14,71
3120 08	1 1/2"	0,590	4-36	23,78
3120 09	2"	0,817	2-28	30,72
3120 10	2 1/2"	1,490	1-16	60,91
3120 11	3"	2,130	1-12	87,75
3120 12	4"	3,473	1-7	151,22

Ref. 3131



Válvula de retención "Europa"

PN 25 - PN 18 - PN 12. Construcción en latón UNE-EN 12165. Cierre en NBR (goma) 65 sh. Muelle en acero inox. AISI 302. Extremos rosca gas (BSP) H-H - ISO 228/1. Temp. máx. 100°C. Montaje en cualquier posición.

"Europa" check valve

PN 25 - PN 18 - PN 12. Body brass UNE-EN 12165. NBR (rubber) sealing 65 sh/ps. Stainless steel spring AISI 302. Gas threaded ends (BSP) F-F - ISO 228/1. Max. temp. 100°C. Assembling: any position.

R	PN	P	B	A
3/8"	25	10	35	54
1/2"	25	15	35	57
3/4"	25	20	42	64
1"	25	25	48	75
1 1/4"	18	32	61	82
1 1/2"	18	40	71	93
2"	18	50	87	100
2 1/2"	12	65	120	120
3"	12	79	140	140
4"	12	100	173	158

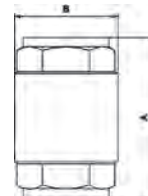

3131 03	3/8"	0,181	10-130	7,71
3131 04	1/2"	0,194	10-120	7,67
3131 05	3/4"	0,280	8-88	10,24
3131 06	1"	0,420	6-54	14,08
3131 07	1 1/4"	0,650	4-36	23,29
3131 08	1 1/2"	0,850	4-32	31,84
3131 09	2"	1,320	2-20	48,28
3131 10	2 1/2"	2,813	1-9	111,82
3131 11	3"	4,186	1-6	167,69
3131 12	4"	5,920	1-4	284,94

Ref. 3140



Válvula de pie "York"

PN 12 - PN 10 - PN 6. Construcción en latón UNE-EN 12165. Cierre en NBR (goma) 65 sh. Muelle en acero inox. AISI 302. Extremo rosca gas (BSP) H - ISO 228/1. Temp. máx. 100°C.

"York" valve with filter

PN 12 - PN 10 - PN 6. Body brass UNE-EN 12165. NBR (rubber) sealing 65 sh. Stainless steel spring AISI 302. Gas threaded end (BSP) F - ISO 228/1. Max. temp. 100°C.

R	PN	P	B	A
3/8"	12	10	35	69,5
1/2"	12	15	35	70
3/4"	12	20	42	82
1"	12	25	48	91,5
1 1/4"	10	32	59,5	108
1 1/2"	10	40	70,5	119
2"	10	50	86	136,5
2 1/2"	6	65	103	164,5
3"	6	80	126	184,5
4"	6	100	154	214,5

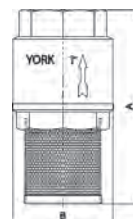

3140 03	3/8"	0,092	10-220	4,49
3140 04	1/2"	0,096	10-220	4,59
3140 05	3/4"	0,141	8-144	5,96
3140 06	1"	0,205	8-120	7,66
3140 07	1 1/4"	0,284	6-60	10,45
3140 08	1 1/2"	0,438	4-48	15,65
3140 09	2"	0,604	2-26	22,40
3140 10	2 1/2"	1,140	1-25	42,06
3140 11	3"	1,675	1-17	59,24
3140 12	4"	2,465	1-10	100,49

Ref. 3160 - 3160N



Filtro válvula retención

Tamiz acero inox - AISI 304. Racor nylon 6.6. Extremos rosca gas (BSP) M - ISO 228/1.

También disponible con rosca NPT (3160N)

Stainless steel strainer for check valves

Stainless steel sieve AISI 304. Nylon 6.6. Gas threaded end (BSP) M - ISO 228/1.

Also available NPT thread (3160N).

R	Luz/Light (microns)	D	A
3/8"	1000	49	23
1/2"	1000	51	27
3/4"	1000	57	34
1"	1000	58	40
1 1/4"	1000	69	48
1 1/2"	1000	81	58
2"	1000	96	68
2 1/2"	1200	96	83
3"	1200	116	100
4"	1200	132	127

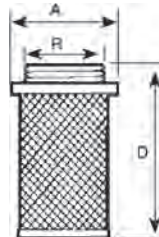

CÓDIGO CODE	MEDIDA SIZE	PESO WEIGHT	CAJA / BOX CARTON	P.V.P. € PRICE €
3160 03	3/8"	0,006	30-900	1,06
3160 04	1/2"	0,008	30-900	1,09
3160 05	3/4"	0,011	15-450	1,31
3160 06	1"	0,016	15-270	1,48
3160 07	1 1/4"	0,024	10-180	1,74
3160 08	1 1/2"	0,035	10-120	2,46
3160 09	2"	0,056	5-60	2,94
3160 10	2 1/2"	0,078	1-48	6,58
3160 11	3"	0,109	1-18	7,73
3160 12	4"	0,186	1-18	11,97

Precios rosca NPT a consultar / NPT thread prices on request

Ref. 3145 - 3145N



Válvula fondo

PN 10 - PN 8 - PN 6. Construcción en latón UNE-EN 12165. Cierre en NBR 65 sh. Extremos rosca gas (BSP) H - ISO 228/1. Temp. máx. 90°C.

También disponible con rosca NPT (3145N)

Bottom valve

PN 10 - PN 8 - PN 6. Body brass UNE-EN 12165. Rubber sealing guided seat. Gas threaded ends (BSP) F - ISO 228/1. Max. temp. 90°C.

Also available NPT thread (3145N).

R	PN	P	D	A
3/4"	10	20	45,5	73
1"	10	25	52	81
1 1/4"	8	32	61,5	93,5
1 1/2"	8	40	68,5	102,5
2"	8	50	80	116,5
2 1/2"	6	65	103	136
3"	6	80	116,5	149,5
4"	6	100	145,5	187

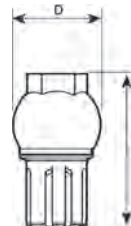

3145 05	3/4"	0,220	20-160	8,36
3145 06	1"	0,265	15-120	10,01
3145 07	1 1/4"	0,421	6-72	14,87
3145 08	1 1/2"	0,585	5-60	19,20
3145 09	2"	0,855	4-32	29,97
3145 10	2 1/2"	1,344	1-24	45,96
3145 11	3"	2,150	1-18	59,73
3145 12	4"	3,318	1-8	110,27

Precios rosca NPT a consultar / NPT thread prices on request

Ref. 3180 - 3180N



Válvula de retención clapeta goma

PN 12/8. Construcción en latón UNE-EN 12165. Cierre NBR (goma) 65 sh. Extremos rosca gas (BSP) H-H - ISO 228/1. Temp. máx. 100°C. Montaje en horizontal.

También disponible con rosca NPT (3180N)

Rubber swing check valve

PN 12/8. Body brass UNE-EN 12165. Rubber sealing. Gas threaded ends (BSP) F-F - ISO 228/1. Max. temp. 100°C. Horizontal assembling.

Also available NPT thread (3180N).

R	P	A	L	PN
1/2"	15	46,5	47	12
3/4"	20	54,5	52	12
1"	25	61,5	64,5	12
1 1/4"	30	72	74	10
1 1/2"	35	84	86	10
2"	45	94	97	10
2 1/2"	57	108	116,5	8
3"	60	130	137	8
4"	90	165	163	8

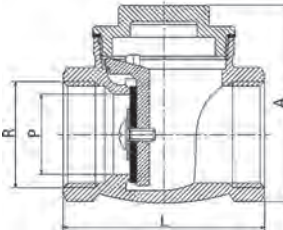

3180 04	1/2"	0,164	20-160	6,04
3180 05	3/4"	0,221	12-96	8,15
3180 06	1"	0,322	10-80	12,30
3180 07	1 1/4"	0,458	8-64	15,33
3180 08	1 1/2"	0,724	5-40	23,44
3180 09	2"	1,010	3-30	32,30
3180 10	2 1/2"	1,476	1-25	45,39
3180 11	3"	2,344	1-16	73,44
3180 12	4"	3,792	1-8	129,69

Precios rosca NPT a consultar / NPT thread prices on request

Ref. 3185 - 3185N



Válvula de retención clapeta metal

PN 12/8. Cierre metálico. Construcción en latón UNE-EN 12165. Extremos rosca gas (BSP) H-H - ISO 228/1. Temp. máx. 200°C. Montaje en horizontal.

También disponible con rosca NPT (3185N)

Metal swing check valve

PN 12/8. Metal sealing. Body brass UNE-EN 12165. Gas threaded ends (BSP) F-F - ISO 228/1. Max. temp. 200°C. Horizontal assembling.

Also available NPT thread (3185N).

R	P	A	L	PN
1/2"	15	46,5	47	12
3/4"	20	54,5	52	12
1"	25	61,5	64,5	12
1 1/4"	30	72	74	10
1 1/2"	35	84,5	86	10
2"	45	94	97	10
2 1/2"	57	107	116,5	8
3"	60	130,5	137	8
4"	90	140,5	161	8

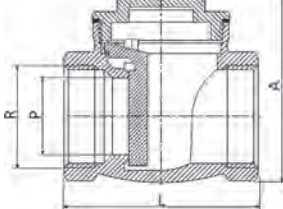

3185 04	1/2"	0,168	20-160	6,04
3185 05	3/4"	0,220	12-96	8,15
3185 06	1"	0,328	10-80	12,30
3185 07	1 1/4"	0,471	8-64	15,33
3185 08	1 1/2"	0,726	5-40	23,44
3185 09	2"	1,010	3-30	32,30
3185 10	2 1/2"	1,451	1-25	45,39
3185 11	3"	2,350	1-16	73,44
3185 12	4"	3,723	1-8	129,69

Precios rosca NPT a consultar / NPT thread prices on request

Ref. 3190 - 3190N



Válvula de alivio de presión con escape conducido

PN 16. Cierre PTFE. Construcción en latón UNE-EN 12165. Muelle en acero galvanizado. Regulación de: 0 - 10 bar (3/8" - 3") y de 5 - 10 bar (4"). Extremos en escuadra rosca gas (BSP) H-H - ISO 228/1. Temp. -10°C +180°C. También disponible con rosca NPT (3190N)

Pressure relief valve with conveyed discharge

PN 16. PTFE sealing. Body brass UNE-EN 12165. Galvanized steel spring. Adjustable: from 0 - 10 bar (3/8" to 3") and 5 - 10 bar (4"). Gas threaded end (BSP) F-F - ISO 228/1. Working temperature: -10°C +180°C. Also available NPT thread (3190N).

R	DN	L	L1	H
3/8"	10	45	24,5	115
1/2"	15	56	30	122
3/4"	20	64	32	149
1"	25	76	40	163
1 1/4"	32	90	44	192
1 1/2"	40	100	47	218
2"	50	124	60	247
2 1/2"	65	148	85	295
3"	80	157	88	330
4"	100	175	95	385

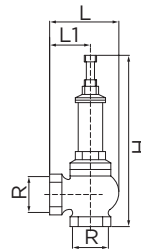

CÓDIGO CODE	MEDIDA SIZE	PESO WEIGHT	CAJA / BOX CARTON	P.V.P. € PRICE €
3190 03	3/8"	0,295	10-80	27,22
3190 04	1/2"	0,340	10-80	27,22
3190 05	3/4"	0,610	6-48	33,57
3190 06	1"	0,900	4-32	44,77
3190 07	1 1/4"	1,380	3-18	76,91
3190 08	1 1/2"	1,830	2-10	92,15
3190 09	2"	2,875	1-5	143,92
3190 10	2 1/2"	5,800	1-4	381,17
3190 11	3"	7,500	1-3	461,58
3190 12	4"	14,850	1-1	1001,90

Ref. 3220 - 3222



Válvula de compuerta latón

PN 16. Paso estándar. Construcción en latón UNE-EN 12165. Temp. máx. 110°C. Extremos rosca gas (BSP) H-H - ISO 228/1. También disponible con rosca NPT (3222)

Brass gate valve

PN 16. Standard bore. Body brass UNE-EN 12165. Max. temp. 110°C. Gas threaded ends (BSP) F-F - ISO 228/1. Also available NPT thread (3222).

R	PN	P	A	L	M
1/2"	16	13	62	36,8	51
3/4"	16	15	66	42,5	55,8
1"	16	19	73	45,8	60
1 1/4"	16	27	91	50,8	60,6
1 1/2"	16	33	98	54	70,8
2"	16	42	127	62,8	92
2 1/2"	16	57	160	68	100
3"	16	60	190	83	110
4"	16	91	238	92	132

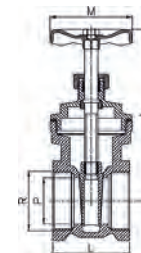

3220 04	1/2"	0,158	16-96	5,89
3220 05	3/4"	0,206	12-72	7,38
3220 06	1"	0,291	8-48	10,85
3220 07	1 1/4"	0,436	6-36	16,06
3220 08	1 1/2"	0,620	4-48	21,88
3220 09	2"	1,056	2-24	38,29
3220 10	2 1/2"	1,890	1-12	65,22
3220 11	3"	2,526	1-8	92,20
3220 12	4"	4,518	1-4	167,25

Precios rosca NPT a consultar / NPT thread prices on request

Ref. 3221 - 3221N



Válvula de compuerta latón

PN 20. Paso estándar. Construcción en latón según UNE-EN 12165. Temp. máx. 180°C. Extremos rosca gas (BSP) H-H - ISO 228/1. Volante aluminio. También disponible con rosca NPT (3221N)

Brass gate valve

PN 20. Standard bore. Brass construction UNE-EN 12165. Max. temp. 180°C. Gas threaded ends (BSP) F-F - ISO 228/1. Aluminium wheel. Also available NPT thread (3221N).

R	PN	P	A	L	M
1/2"	20	14	76	45,5	54
3/4"	20	20	87	49,3	60
1"	20	25	98	56	64
1 1/4"	20	32	110	60	74
1 1/2"	20	37	124	65	80
2"	20	47	174	74	90
2 1/2"	20	59	180	81	110
3"	20	70	201	83	110
4"	20	92	248	102	140

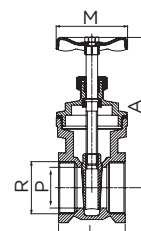

3221 04	1/2"	0,247	10-100	9,04
3221 05	3/4"	0,360	8-48	13,47
3221 06	1"	0,481	5-50	19,68
3221 07	1 1/4"	0,722	4-24	28,29
3221 08	1 1/2"	0,963	2-24	36,90
3221 09	2"	1,350	2-16	56,00
3221 10	2 1/2"	2,278	1-6	90,10
3221 11	3"	3,134	1-6	135,16
3221 12	4"	5,390	1-4	249,67

Precios rosca NPT a consultar / NPT thread prices on request

Ref. 3230



Válvula de asiento inclinado

PN 16. Paso total. Construcción en latón UNE-EN 12165. Cierre EPDM. Temp. máx. 100°C. Extremos rosca gas (BSP) H-H - ISO 228/1.

Slanted seat valve

PN 16. Full bore. Body brass UNE-EN 12165. EPDM sealing. Max. temp. 100°C. Gas threaded ends (BSP) F-F - ISO 228/1.

R	DN	A	L
1/2"	15	66	57
3/4"	20	70	66
1"	25	97	80
1 1/4"	32	115	92
1 1/2"	40	131	101
2"	50	155	121
2 1/2"	65	225	151
3"	78	232	172
4"	98	320	219

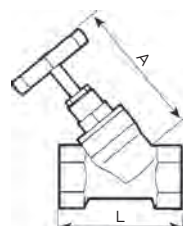

3230 04	1/2"	0,176	10-80	8,80
3230 05	3/4"	0,265	6-48	12,31
3230 06	1"	0,467	5-30	20,08
3230 07	1 1/4"	0,830	2-16	34,23
3230 08	1 1/2"	0,996	1-8	42,99
3230 09	2"	1,576	1-5	68,52
3230 10	2 1/2"	-	1-5	178,40
3230 11	3"	-	1-4	245,11
3230 12	4"	9,000	1-2	431,44

Ref. 3186



Válvula de retención clapeta PTFE

PN 16. Cierre en PTFE. Construcción en **Bronce** UNE-EN 1982 - Latón UNE-EN 12165. Extremos rosca gas (BSP) H-H - ISO 228/1. Temp. máx. 180°C.

PTFE swing check valve

PN 16. PTFE sealing. Construction **Bronze** UNE-EN 1982 - Brass UNE-EN 12165. Gas threaded end (BSP) F-F - ISO 228/1. Max. Temp. 180°C.

R	L	A
1/2"	60	38
3/4"	70	49
1"	80	55
1 1/4"	95	59
1 1/2"	105	69
2"	130	78

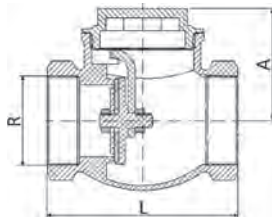

CÓDIGO CODE	MEDIDA SIZE	PESO WEIGHT	CAJA / BOX CARTON	P.V.P. € PRICE €
3186 04	1/2"	0,258	10	59,67
3186 05	3/4"	0,430	6-48	65,55
3186 06	1"	0,688	4	104,23
3186 07	1 1/4"	0,947	2-16	122,80
3186 08	1 1/2"	1,430	2-16	172,80
3186 09	2"	2,235	1-8	228,00

Precios rosca NPT a consultar / NPT thread prices on request

Ref. 3187



Válvula de retención cierre PTFE

PN 16. Cierre en PTFE. Construcción en **Bronce** UNE-EN 1982 - Latón UNE-EN 12165. Muelle en acero inoxidable. Extremos rosca gas (BSP) H-H - ISO 228/1. Temp. máx. 180°C.

PTFE sealing check valve

PN 16. PTFE sealing. Construction **Bronze** UNE-EN 1982 - Brass UNE-EN 12165. Stainless steel spring. Gas threaded end (BSP) F-F - ISO 228/1. Max. Temp. 180°C.

R	L	A
3/8"	45	38
1/2"	50	39
3/4"	61	48
1"	71	53
1 1/4"	85	56
1 1/2"	90	63
2"	110	72

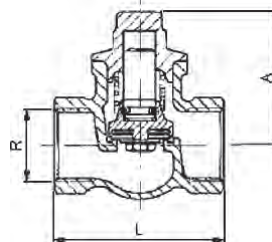

3187 03	3/8"	0,150	20-120	25,72
3187 04	1/2"	0,205	20-120	24,46
3187 05	3/4"	0,330	10-60	30,56
3187 06	1"	0,472	6-36	44,13
3187 07	1 1/4"	0,790	4-24	71,33
3187 08	1 1/2"	0,997	4-24	93,95
3187 09	2"	1,673	2-12	132,04

Ref. 3228

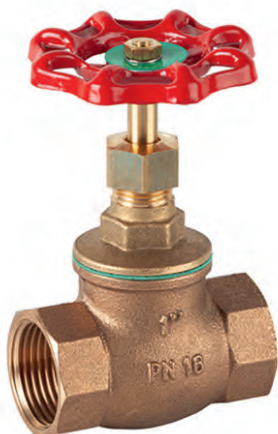

Válvula de asiento de globo

PN 16. Cierre en PTFE. Construcción en **Bronce** UNE-EN 1982 - Latón UNE-EN 12165. Extremos rosca gas (BSP) H-H - ISO 228/1. Temp. máx. 180°C. Volante de aluminio.

Globe valve

PN 16. PTFE sealing. Construction **Bronze** UNE-EN 1982 - Brass UNE-EN 12165. Gas threaded end (BSP) F-F - ISO 228/1. Max. Temp. 180°C. Aluminium wheel.

R	L	A	M
3/8"	45	67	50
1/2"	50	80	50
3/4"	62	85	50
1"	71	94	60
1 1/4"	85	106	70
1 1/2"	90	118	80
2"	110	127	80

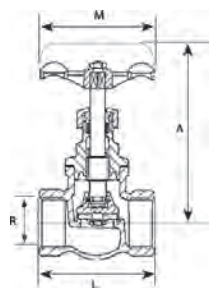

3228 03	3/8"	0,180	10-60	30,25
3228 04	1/2"	0,252	10-80	31,39
3228 05	3/4"	0,394	8-64	36,07
3228 06	1"	0,566	4-32	45,74
3228 07	1 1/4"	0,900	2-16	73,38
3228 08	1 1/2"	1,135	2-16	98,37
3228 09	2"	1,893	1-6	162,40

Ref. 3227



Válvula de bronce con retención y eje libre

PN 16. Paso total. Construcción en **Bronce** UNE-EN 1982 - Latón UNE-EN 12165. Cierre EPDM (WRAS). Extremos rosca H-H - ISO 7/1 (EN 10226-1). Temperatura máxima de trabajo 100°C. Volante de aluminio.

Bronze loose-jumper stop valve

PN 16. Full bore. **Bronze** construction UNE-EN 1982 - Brass UNE-EN 12165. EPDM (WRAS) seal. F-F threaded ends ISO 7/1 (EN 10226-1). Maximum working temperature 100°C. Aluminium wheel.

R	PN	P	A	L	M
3/4"	16	19	78	58	63
1"	16	25	80	74	63
1 1/4"	16	32	112	89	80
1 1/2"	16	38	113	97,5	80

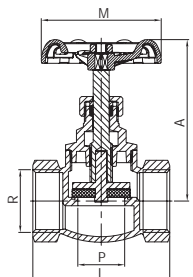

3227 05	3/4"	0,306	10-60	29,61
3227 06	1"	0,445	6-36	35,82
3227 07	1 1/4"	0,987	4-24	65,56
3227 08	1 1/2"	1,109	3-18	88,06

Ref. 3229



Válvula de compuerta de bronce

PN 20. Paso estándar. Construcción en **Bronce** UNE-EN 1982. Latón UNE-EN 12165. Extremos rosca gas (BSP) H-H - ISO 228/1. Temperatura máxima de trabajo 180°C. Volante de aluminio.

Bronze gate valve

PN 20. Standard bore. **Bronze** construction UNE-EN 1982. brass UNE-EN 12165. Gas threaded ends (BSP) F-F-ISO 228/1. Maximum working temperature 180°C. Aluminium wheel.

R	PN	P	A	L	M
1/2"	20	14	75	49	54
3/4"	20	18	83	52	60
1"	20	23	92	60	64
1 1/4"	20	27	106	64	74
1 1/2"	20	35	121	70	80
2"	20	45	144	74	88
2 1/2"	20	58	184	88	110

CÓDIGO CODE	MEDIDA SIZE	PESO WEIGHT	CAJA / BOX CARTON	P.V.P. € PRICE €
3229 04	1/2"	0,235	14-84	16,12
3229 05	3/4"	0,327	10-60	21,28
3229 06	1"	0,491	6-36	34,21
3229 07	1 1/4"	0,738	4-36	48,36
3229 08	1 1/2"	1,011	3-18	64,48
3229 09	2"	1,576	2-12	100,52
3229 10	2 1/2"	3,013	1-6	191,45

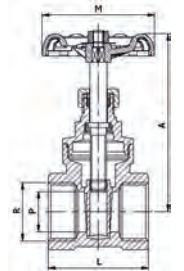

Ref. 3236



Válvula de compuerta para transformadores

Construcción en Bronce UNE-EN 1982 - Latón UNE-EN 12165. Extremos Bridas EN 1092 PN 16. Con indicador de posición y dispositivo de bloqueo. Máxima presión de trabajo 6 bar. Temperatura del fluido -40°C / +120°C.

Gate valve for transformers

Construction Bronze UNE-EN 1982 - Brass UNE-EN 12165. Flanged ends EN 1092 PN 16. With position indicator and locking device. Maximum working pressure 6 bar. Fluid temperature -40°C / +120°C.

ØDN	A	B	C
15	95	77	130
25	115	77	150
32	140	86	185
40	150	120	200
50	165	135	220
80	200	185	290

3236 04	1/2"	1,500	-	237,28
3236 06	1"	2,800	-	253,33
3236 07	1 1/4"	4,300	-	394,44
3236 08	1 1/2"	5,000	-	511,43
3236 09	2"	7,427	-	723,31
3236 11	3"	13,093	-	1649,77

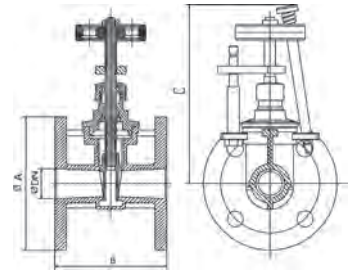

Ref. 3193



Válvula de alivio de presión

PN 16. Construcción en latón UNE-EN 12165 cromado. Extremos rosca M-H, ISO 228/1. Muelles acero inox. Taraje estándar fijo a 8 bar. Cierre NBR. Temperatura máxima 110°C.

Pressure relief valve

PN 16. Body chrome plated brass UNE-EN 12165. Threaded end M-F, ISO 228/1. Stainless steel springs. Standard tare 8 bar. NBR sealing. Maximum temperature 110°C.

R	P	A	B
1/2"	10,5	40	52
3/4"	10,5	54	55

3193 04	1/2"	0,065	20-360	3,33
3193 05	3/4"	0,130	10-180	7,11

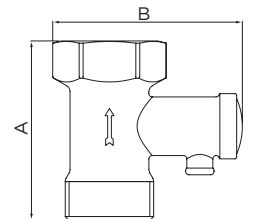

Ref. 3194



Válvula de alivio de presión

Con dispositivo de descarga manual por palanca. PN 16. Construcción en latón UNE-EN 12165 cromado. Extremos rosca M-H, ISO 228/1. Muelles acero inox. Taraje estándar fijo a 8 bar. Cierre NBR. Temperatura máxima 110°C.

Pressure relief valve

Safety check valve with manual unloading device by lever. PN 16. Body chrome plated brass UNE-EN 12165. Threaded end M-F, ISO 228/1. Stainless steel springs. Standard tare 8 bar. NBR sealing. Maximum temperature 110°C.

R	P	A	B
1/2"	10,5	40	62
3/4"	10,5	54	65

3194 04	1/2"	0,068	20-360	3,45
3194 05	3/4"	0,132	10-180	7,34

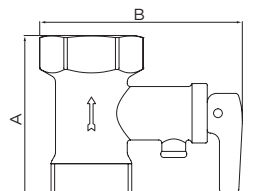

Ref. 3860

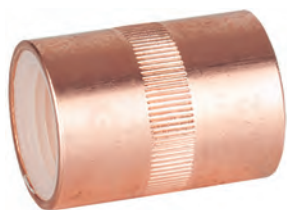

Manguito antielectrólisis

PN 10. Construcción en poliamida 6 (nylon). Funda de cobre. Extremos rosca gas (BSP) H - H - ISO 228/1. Temp. máx. 90°C aire - 80°C agua.

Anti-electrolysis fitting

PN 10. Body nylon. Copper cover. Gas threaded ends (BSP) F-F - ISO 228/1. Max. temp. 90°C air - 80°C water.

R	P	A	L
1/2"	14	28	39
3/4"	20	35	38
1"	25	42	43
1 1/4"	32	54	58
1 1/2"	40	62	59
2"	50	80	75
4"	100	130	103

CÓDIGO CODE	MEDIDA SIZE	PESO WEIGHT	CAJA / BOX CARTON	P.V.P. € PRICE €
3860 04	1/2"	0,039	48-864	2,66
3860 05	3/4"	0,050	30-540	3,64
3860 06	1"	0,073	20-360	4,62
3860 07	1 1/4"	0,162	6-108	12,18
3860 08	1 1/2"	0,187	4-72	20,55
3860 09	2"	0,459	2-36	33,28
3860 12	4"	1,458	1-18	95,14

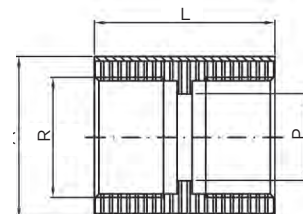

Ref. 3865



Manguito antielectrólisis

PN 10. Construcción en poliamida 6 (nylon). Funda de cobre. Extremos rosca gas (BSP) M - H - ISO 228/1. Temp. máx. 90°C aire - 80°C agua.

Anti-electrolysis fitting

PN 10. Body nylon. Copper cover. Gas threaded ends (BSP) M-F - ISO 228/1. Max. temp. 90°C air - 80°C water.

R	P	A	L
1/2"	15	28	41
3/4"	19	35	42

3865 04	1/2"	0,025	48-864	2,79
3865 05	3/4"	0,041	30-540	3,92

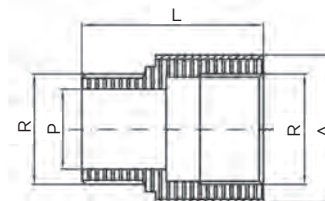

Ref. 3850



Anticalcáreo magnético "Calcolit"

PN 16. Construcción en latón UNE-EN 12165 cromado. Extremos rosca gas (BSP) M-M - ISO 228/1. Temp. máx. 80°C.

"Calcolit" magnetic limestone reducer

PN 16. Chrome plated brass UNE-EN 12165. Gas threaded ends M-M - ISO 228/1. Max. temp. 80°C.

R	A	B
1/2"	56	104
3/4"	56	106
1"	65	128
1 1/4"	79	141
1 1/2"	110	203
2"	110	203

3850 04	1/2"	0,660	6-24	79,70
3850 05	3/4"	0,660	6-24	99,18
3850 06	1"	1,095	1-24	119,33
3850 07	1 1/4"	1,460	1-1	332,17
3850 08	1 1/2"	4,360	1-1	450,77
3850 09	2"	4,350	1-1	547,24

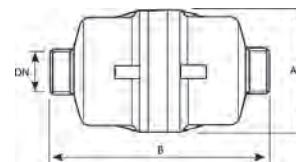

Ref. 3069



Válvula con filtro colador tipo "Y"

PN 16. Construcción en latón UNE-EN 12165. Extremos rosca gas (BSP) hembra. ISO 228/1. Tamiz: inox AISI 304. Luz: 400 micras. Temp. máx. 110°C.

Brass valve with type "Y" strainer filter

PN 16. Body chrome plated brass UNE-EN 12165. Gas threaded ends (BSP) F-F - ISO 228/1. Sieve: stainless steel AISI 304. Light: 400 microns. Max. temp. 110°C.

R	A	L	M
1/2"	66	78	52
3/4"	83	92	60
1"	98	112	68

3069 04	1/2"	0,245	6-108	8,28
3069 05	3/4"	0,340	4-72	13,60
3069 06	1"	0,566	2-36	19,63

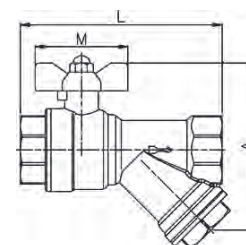

Ref. 3302 - 3302N



Filtro colador tipo "Y" latón

También disponible con rosca NPT (3302N).
PN 16. Cuerpo latón UNE-EN 12165. Tamiz: inox. AISI 304. Junta tapa: NBR.
Temp. máx. 100°C. Extremos rosca gas (BSP).
También disponible con rosca NPT (3302N)

"Y" brass strainer

PN 16. Body brass UNE-EN 12165. Sieve: stainless steel AISI 304. NBR joint.
Max. temp. 100°C. Gas threaded ends (BSP) F-F - ISO 228/1.
Also available NPT thread (3302N).

R	H	L	Luz/Light (microns)
1/2"	38	56,5	500
3/4"	44	66	500
1"	50	74	500
1 1/4"	66	96	500
1 1/2"	71	104	500
2"	89	125	500
2 1/2"	110	154	1200
3"	120	173	1200
4"	152	210	1200

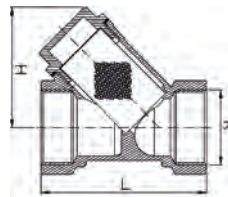

CÓDIGO CODE	MEDIDA SIZE	PESO WEIGHT	CAJA / BOX CARTON	P.V.P. € PRICE €
3302 04	1/2"	0,128	24-192	4,18
3302 05	3/4"	0,182	12-96	6,36
3302 06	1"	0,256	10-80	9,36
3302 07	1 1/4"	0,540	5-60	19,12
3302 08	1 1/2"	0,622	2-36	25,32
3302 09	2"	1,150	1-18	41,93
3302 10	2 1/2"	1,892	1-15	80,28
3302 11	3"	2,748	1-10	110,70
3302 12	4"	4,800	1-4	209,48

Precios rosca NPT a consultar / NPT thread prices on request
Versión niquelada a consultar / Nickel-plated version on request.

Ref. 3304



Filtro colador tipo "Y" bronce

Construcción en bronce según UNE-EN 1982. Latón UNE-EN 12165. Tamiz: inox. AISI 304. Temperatura de trabajo de -20°C a 110°C. Extremos rosca gas (BSP) H - H - ISO 228/1.

Bronze "Y" type strainer filter

Body bronze UNE-EN 1982. Brass UNE-EN 12165. Sieve: stainless steel AISI 304. Working temperature from -20°C to 110°C. Gas threaded end (BSP) F-F - ISO 228/1.

R	PN (bar)	DN	H	L	Luz/Light (microns)
3/8"	16	12	40	55	400
1/2"	16	15	44	59	400
3/4"	16	20	50,5	69	400
1"	16	25	60	82	400
1 1/4"	16	32	73	98,5	500
1 1/2"	16	40	80	109	500
2"	16	50	98	131	500
2 1/2"	10	65	114	151	500
3"	10	78	130	172	500
4"	10	98	170	219	500

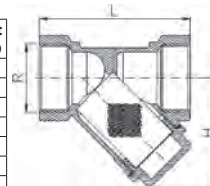

3304 03	3/8"	0,178	25-100	9,44
3304 04	1/2"	0,216	20-120	10,75
3304 05	3/4"	0,342	12-72	17,04
3304 06	1"	0,472	10-60	23,39
3304 07	1 1/4"	0,720	5-30	35,15
3304 08	1 1/2"	0,878	1-25	44,05
3304 09	2"	1,574	1-15	73,54
3304 10	2 1/2"	2,566	1-10	114,22
3304 11	3"	3,444	1-6	160,44
3304 12	4"	7,062	1-3	337,91

Ref. 3310



Filtro polivalente para agua

PN 16. Construcción en latón UNE-EN 12165 cromado. Extremos rosca gas (BSP) H-H - ISO 228/1. Tamiz: acero inox. AISI 304. Luz: 800 micras. Junta tórica NBR. Temp. máx. 110°C.

In-line strainer for water

PN 16. Body chrome plated brass UNE-EN 12165. Gas threaded ends (BSP) F-F - ISO 228/1. Sieve: stainless steel AISI 304. Light: 800 microns. NBR o-ring. Max. temp. 110°C.

R	D	L	M	A
1/2"	27	58	36	62
3/4"	33	74	43	76
1"	40	90	48	87
1 1/4"	49	115	56	105
1 1/2"	58	135	66	115
2"	71	161	80	135

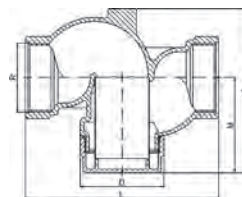

3310 04	1/2"	0,145	10-160	5,60
3310 05	3/4"	0,220	8-80	9,22
3310 06	1"	0,350	6-54	14,26
3310 07	1 1/4"	0,655	5-30	26,65
3310 08	1 1/2"	0,980	2-12	39,21
3310 09	2"	1,530	1-10	62,18

Ref. 3311



Filtro polivalente para gasoil

PN 16. Cuerpo latón UNE-EN 12165 cromado. Extremos rosca gas (BSP) H-H - ISO 228/1. Tamiz: acero inox. AISI 304. Luz: 300 micras. Junta tórica NBR. Temp. máx. 110°C.

In-line strainer for diesel oil

PN 16. Body chrome plated brass UNE-EN 12165. Gas threaded ends (BSP) F-F - ISO 228/1. Sieve: stainless steel AISI 304. Light: 300 microns. NBR o-ring. Max. temp. 110°C.

R	D	L	M	A
1/2"	27	58	36	62
3/4"	33	74	43	76
1"	40	90	48	87
1 1/4"	49	115	56	105
1 1/2"	58	135	66	115
2"	71	161	80	135

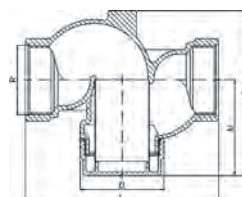

3311 04	1/2"	0,130	10-140	5,72
3311 05	3/4"	0,220	8-80	9,40
3311 06	1"	0,350	6-60	14,48
3311 07	1 1/4"	0,655	5-30	27,42
3311 08	1 1/2"	0,980	2-12	40,74
3311 09	2"	1,530	1-8	63,87

Ref. 3312



Filtro polivalente para gas

PN 16. Cuerpo latón UNE-EN 12165 cromado. Extremos rosca gas (BSP) H-H - ISO 228/1. Tamiz: acero inox. AISI 304. Luz: 50 micras. Junta tórica NBR. Temp. máx. 110°C.

In-line strainer for gas

PN 16. Body chrome plated brass UNE-EN 12165. Gas threaded ends (BSP) F-F - ISO 228/1. Sieve: stainless steel AISI 304. Light: 50 microns. NBR o-ring. Max. temp. 110°C.

R	D	L	M	A
1/2"	27	58	36	62
3/4"	33	74	43	76
1"	40	90	48	87
1 1/4"	49	115	56	105
1 1/2"	58	135	66	115
2"	71	161	80	135

CÓDIGO CODE	MEDIDA SIZE	PESO WEIGHT	CAJA / BOX CARTON	P.V.P. € PRICE €
3312 04	1/2"	0,144	10-160	5,93
3312 05	3/4"	0,220	8-80	10,00
3312 06	1"	0,350	6-60	14,48
3312 07	1 1/4"	0,655	5-30	27,89
3312 08	1 1/2"	0,980	2-12	41,40
3312 09	2"	1,530	1-8	64,89

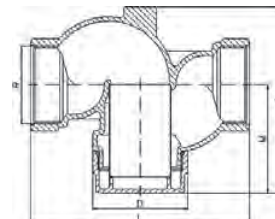

Ref. 3313



Filtro autolimpiante

PN 16. Construcción en latón UNE-EN 12165 cromado. Tamiz reforzado: acero inox. AISI 304. Luz: 100 micras. Junta NBR. Extremos rosca gas (BSP) H-H - ISO 228/1. Temp. máx. 110°C.

Self-cleaning filter

PN 16. Chrome plated brass construction UNE-EN 12165. Reinforced sieve: Stainless steel AISI 304. Light: 100 microns. NBR O-ring. Gas threaded ends (BSP) M-M - ISO 228/1. Max. temp. 110°C.

R	A	L	M
1/2"	189	58	49
3/4"	197	74	56
1"	208	90	61

3313 04	1/2"	0,334	1-40	19,81
3313 05	3/4"	0,423	1-30	24,21
3313 06	1"	0,559	1-24	31,05

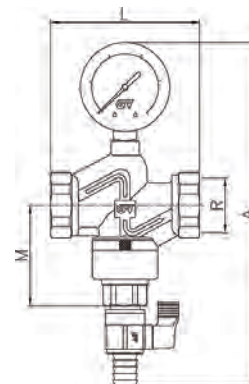

Ref. 3314



Filtro autolimpiante largo

PN 16. Construcción en latón UNE-EN 12165 cromado. Tamiz reforzado: acero inox. AISI 304. Luz: 100 micras. Junta NBR. Extremos rosca gas (BSP) H-H - ISO 228/1. Temp. máx. 110°C.

Long self-cleaning filter

PN 16. Chrome plated brass construction UNE-EN 12165. Reinforced sieve: Stainless steel AISI 304. Light: 100 microns. NBR O-ring. Gas threaded ends (BSP) M-M - ISO 228/1. Max. temp. 110°C.

R	A	L	M
1/2"	212	58	78
3/4"	226	74	84
1"	239	90	92
1 1/4"	265	115	102
1 1/2"	278	135	116
2"	303	161	134

3314 04	1/2"	0,380	1-40	23,38
3314 05	3/4"	0,484	1-30	28,78
3314 06	1"	0,650	1-24	36,97
3314 07	1 1/4"	1,013	1-18	53,87
3314 08	1 1/2"	1,435	1-12	75,38
3314 09	2"	2,103	1-6	110,44

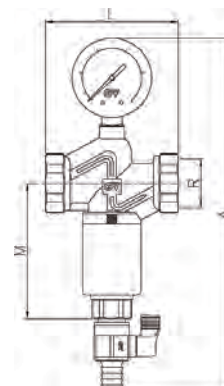

Ref. 3316



Filtro autolimpiante "CLEAN"

PN 16. Construcción en latón niquelado. Tamiz: acero inox. AISI 304. Luz: 100 micras. Extremos rosca gas (BSP) M-M - ISO 228/1. Con dos manómetros y válvula de vaciado. Máx. temperatura 100°C.

"CLEAN" Self-cleaning filter

PN 16. Nickel plated brass construction. Sleeve: Stainless steel AISI 304. Light: 100 micron. Gas thread ends (BSP) M-M - ISO 228/1. With double pressure gauge and discharge valve. Max. temperature 100°C.

R	A	B
1/2"	257	145
3/4"	257	155
1"	267	164

CÓDIGO CODE	MEDIDA SIZE	PESO WEIGHT	CAJA / BOX CARTON	P.V.P. € PRICE €
----------------	----------------	----------------	----------------------	---------------------

3316 04	1/2"	0,940	1	231,89
3316 05	3/4"	1,110	1	256,70
3316 06	1"	-	1	336,87

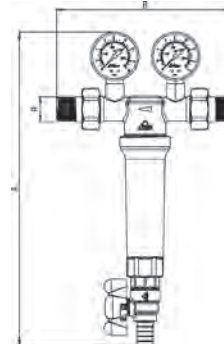

Ref. 3316E

NEW



Filtro autolimpiante "CLEAN"

PN 16. Construcción en latón UNE-EN 12165. Tamiz de acero inox AISI 316. Luz 45 micras. Cuerpo extremos roscados (BSP) M-M 1" según ISO 228/1. Racor reducción 1" x 3/4" incluido. Manómetro 0 - 16 bar y válvula de vaciado. Temperatura máxima de trabajo 80°C.

"CLEAN" Self-cleaning filter

PN 16. Body brass UNE-EN 12165. Sleeve stainless steel AISI 316. Light 45 micron. Body gas threaded ends ISO 228/1 - M-M 1". Reduction connector 1" x 3/4" included. With pressure gauge 0 - 16 bar and discharge valve. Max. working temperature 80°C.

R	A	L
3/4"	294	159

CONEXIONES / CONNECTIONS		
ITEM	OPTION 1	OPTION 2
BODY / CUERPO	M-M 1"	F-F 3/4"
FITTINGS / RACORES	M-M 3/4"	F-F 1"

3316E 05	3/4"	0,976	1-12	71,53
----------	------	-------	------	-------

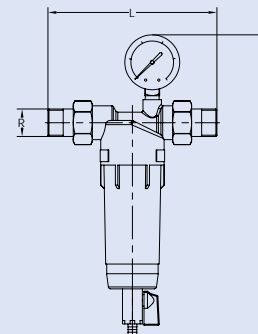

Ref. 3317

NEW



Amortiguador anti golpe de ariete "STOP-GE"

PN 10. Construcción en latón niquelado UNE-EN 12165. Diafragma de EPDM peróxido. Muelle en acero zincado EN 10270. Extremos rosca gas (BSP) M - ISO 228/1. Temperatura máxima de trabajo 90°C. El amortiguador anti-golpe de ariete "STOP-GE" ha sido diseñado para atenuar el fenómeno del "golpe de ariete" que se genera al cerrar un conducto, generando de manera abrupta una variación de la velocidad del fluido.

"STOP-GE" water hammer damper

PN 10. Nickel plated brass construction UNE-EN 12165. EPDM perox diaphragm. Zinc plated steel spring EN 10270. Gas threaded ends (BSP) M -ISO 228/1. Maximum working temperature 90°C. The "STOP-GE" water hammer damper has been designed to attenuate the "water hammer" phenomenon which is created in a closed conduct when there is an abrupt variation in the fluid speed.

R	A	B	C	H
1/2"	52	45	13,5	90

3317 04	1/2"	0,565	1-56	29,60
---------	------	-------	------	-------

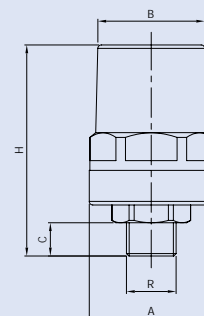

VÁLVULAS REDUCTORAS DE PRESIÓN / PRESSURE REDUCER VALVES



CARACTERÍSTICAS DE LAS VÁLVULAS

- Disminuyen y estabilizan la presión según requerimiento
- Diferentes tipos, pistón (3318, 3320, 3320E) y membrana (3340, 3324, 3342)
- Construidas en latón UNE-EN 12165 o AISI 316 (2272), resistente a la corrosión
- Acabado cromado, niquelado o Inoxidable
- Conexiones roscadas G ISO 228/1 o R ISO 7-1 (2272)
- Disponibles de PN16 a PN40
- Disponibles en diferentes dimensiones y rangos de presión

VALVES CHARACTERISTICS

- Decrease and stabilize the pressure as required
- Available different types, pistón (3318, 3320, 3320E) and membrane (3340, 3324, 3342)
- Construction in EN 12165 brass or AISI 316, corrosion resistant
- Chrome plated, nickel plated or stainless steel finished
- Threaded ends G ISO 228/1 and R ISO 7/1 (2272)
- Available from PN16 to PN40
- Available several dimensions and pressure ranges

Ref. 3318 - 3318N



Válvula reductora de presión Redux-GE a pistón

PN 25. Construcción en latón UNE-EN 12165 niquelado. Cierre acero inox. AISI 303. Muelle en acero zincado EN-10270. Juntas EPDM perox. Extremos rosca gas (BSP) H-H - ISO 228/1. Temp. máx. trabajo 130°C.

También disponible con rosca NPT (3318N)

Redux-GE pressure reducing valve - Piston type

PN 25. Nickel plated brass construction UNE-EN 12165. AISI 303 stainless steel sealing. Zinc plated steel spring EN-10270. EPDM perox joints. Gas threaded ends (BSP) F-F - ISO 228/1. Max. working temp. 130°C.

Also available NPT thread (3318N).

R	A	Ø B	C	L	Presión salida / Output pressure	
					Min.	Max.
1/2"	114	48	63	69	1	5,5
3/4"	114	48	63	82	1	5,5
1"	146	59	73	96	1	5,5
1 1/4"	152	59	73	100	1	5,5
1 1/2"	148,5	59	77	91	1	5,5
2"	150,5	59	81	97	1	5,5
2 1/2"	263,5	76	112	147	1,5	7
3"	285	82,5	112	179	1,5	7
4"	325	88,5	124	189	1,5	7

CÓDIGO CODE	MEDIDA SIZE	PESO WEIGHT	CAJA / BOX CARTON	P.V.P. € PRICE €
3318 04	1/2"	0,540	1-40	23,72
3318 05	3/4"	0,600	1-40	26,46
3318 06	1"	1,020	1-20	43,27
3318 07	1 1/4"	1,120	1-20	67,88
3318 08	1 1/2"	1,340	1-20	84,55
3318 09	2"	1,450	1-20	97,92
3318 10	2 1/2"	4,100	1-6	296,08
3318 11	3"	5,520	1-3	409,00
3318 12	4"	6,970	1-2	950,74

Precios rosca NPT a consultar / NPT thread prices on request

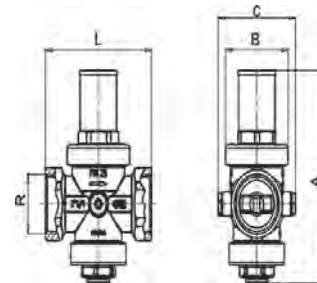

Ref. 3320E



Válvula reductora de presión a pistón "Rinoxdos"

PN25. Cuerpo en latón niquelado UNE-EN 12165. Cierre inox AISI 304 y goma EPDM. Muelle en acero galvanizado. Juntas tóricas en EPDM. Extremos rosca gas (BSP) H-H ISO 228/1. Campo de regulación 0,5 a 6 bar. Presión salida establecida 3 bar.

"Rinoxdos" pressure reducing valve - Piston type

PN 25. Nickel plated brass UNE-EN 12165. Sealing inox AISI 304 and EPDM rubber. Galvanized steel spring. EPDM o-rings. Gas threaded ends (BSP) F-F ISO 228/1. Adjustable range from 0,5 to 6 bar. Outlet setting pressure 3 bar.

R	A	B	C	L	Presión salida (bar)/Output pressure (bar)	
					Min.	Max.
1/2"	100	65	32	69	0,5	6
3/4"	100	65	32	82	0,5	6

3320E 04	1/2"	0,540	1-24	23,74
3320E 05	3/4"	0,570	1-24	27,17

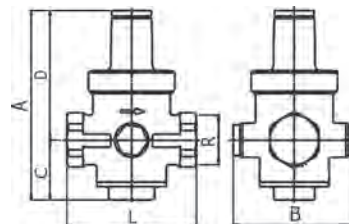

Ref. 3320



Válvula reductora de presión "Rinoxdue" a pistón

PN25. Cuerpo latón UNE-EN 12165 cromado. Cierre inox AISI 303. Juntas tóricas NBR. Extremos rosca gas (BSP) H-H ISO 228/1. Campo de regulación 0,5 a 7 bar. Presión salida establecida 3 bar.

"Rinoxdue" pressure reducing valve - Piston type

PN 25. Body chrome plated brass UNE-EN 12165. Sealing inox AISI 303. Gas threaded ends (BSP) F-F ISO 228/1. Adjustable range from 0,5 to 7 bar. Outlet setting pressure 3 bar.

R	A	L	P	Presión salida / Output pressure	
				Min.	Max.
1/2"	110	60	69	0,5	4
3/4"	110	60	69	0,5	4
1"	152	86	92	0,5	7
1 1/4"	158	91	93	0,5	7
1 1/2"	163	91	98	0,5	7
2"	171	91	101	0,5	7

3320 04	1/2"	-	1-40	27,25
3320 05	3/4"	-	1-40	29,07
3320 06	1"	1,140	1-6	77,66
3320 07	1 1/4"	1,370	1-10	100,90
3320 08	1 1/2"	1,436	1-10	129,67
3320 09	2"	1,530	1-10	167,47

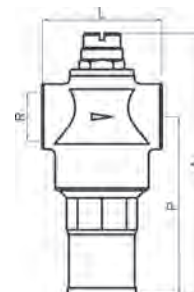

Ref. 3340



Válvula reductora de presión "Rinox" a membrana

PN 40. Caudal total. Cuerpo latón UNE-EN 12165 cromado. Cierre acero inox AISI 304. Muelle en acero al silicio zincado. Membrana y juntas tóricas: NBR. Presión entrada máx. 16 bar. Extremos rosca gas (BSP) H-H - ISO 228/1

"Rinox" membrane pressure reducing valve

PN 40. Full flow. Body chrome plated brass UNE-EN 12165. Sealing inox AISI 304. Zinc plated silicone steel spring o-ring NBR. Membrane: reinforced EPDM. Max. input pressure 16 bar. Gas threaded ends (BSP) F-F - ISO 228/1.

R	A	L	P	PN	Presión salida / Output pressure	
					Min.	Max.
1/2"	135	76,5	83	40	0,8	5,5
3/4"	135	76,5	83	40	0,8	5,5
1"	198	95	135	40	0,8	5,5
1 1/4"	220	116	153	40	0,8	7
1 1/2"	235	122	163	40	0,8	7
2"	235	126	163	40	0,8	7
2 1/2"	390	180	290	40	0,8	7
3"	390	188	290	40	0,8	7
4"	390	202	290	40	0,8	7

CÓDIGO CODE	MEDIDA SIZE	PESO WEIGHT	CAJA / BOX CARTON	P.V.P. € PRICE €
3340 04	1/2"	1,400	1-20	73,00
3340 05	3/4"	1,440	1-20	78,99
3340 06	1"	1,680	1-6	115,39
3340 07	1 1/4"	2,505	1-4	184,15
3340 08	1 1/2"	2,931	1-8	256,02
3340 09	2"	3,140	1-1	337,03
3340 10	2 1/2"	12,120	1-1	1037,87
3340 11	3"	13,140	1-1	1333,78
3340 12	4"	13,260	1-1	2012,40

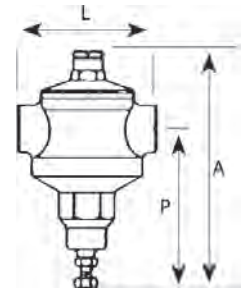

Ref. 3324



Válvula reductora de presión a membrana con filtro

PN 16. Cuerpo en latón anticorrosión DZR UNE-EN 12165 niquelado. Membrana en NBR. Filtro en acero inox AISI 302, 800 micras. Juntas en NBR. Extremos rosca gas (BSP) H-H ISO 228/1. Temperatura máx. de trabajo 80°C. Presión máxima entrada 16 bar. Campo de regulación 0,5 a 7 bar. Presión de salida establecida 3 bar.

Membrane pressure reducing valve with filter

PN 16. Body nickel plated DZR anticorrosion brass construction UNE-EN 12165. Membrane NBR. Filter stainless steel AISI 302, 800 microns. O-rings NBR. Gas threaded ends (BSP) F-F ISO 228/1. Max. working temperature 80°C. Max. inlet pressure 16 bar. Adjustable range from 0,5 to 7 bar. Outlet setting pressure 3 bar.

R	A	B	C	Ø D	Presión salida / Output pressure	
					Min.	Max.
1/2"	75	17	108	46	0,5	7
3/4"	78	19	111	46	0,5	7

3324 04	1/2"	0,45	1-20	46,14
3324 05	3/4"	0,5	1-20	58,80

Precios a consultar / Prices on request

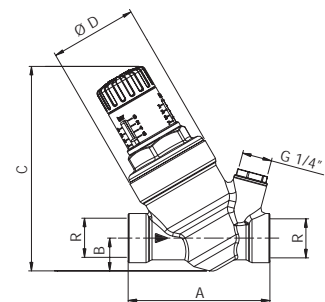

Ref. 3324R



Válvula reductora de presión a membrana con racord y filtro

PN 16. Construcción en latón anticorrosión DZR según UNE-EN 12165 niquelado. Membrana en NBR. Filtro en acero inox AISI 302, 800 micras. Juntas en NBR. Extremos rosca gas con racores (BSP) M-M ISO 228/1. Temperatura máx. trabajo 80°C. Presión máxima entrada 16 bar. Campo de regulación 0,5 a 7 bar. Presión de salida establecida 3 bar.

Membrane pressure reducing valve with connectors and filter

PN 16. Body nickel plated DZR anticorrosion brass construction UNE-EN 12165. Membrane NBR. Filter stainless steel AISI 302, 800 microns. O-rings NBR. Gas threaded ends with connectors (BSP) M-M ISO 228/1. Max. working temperature 80°C. Max. inlet pressure 16 bar. Adjustable range from 0,5 to 7 bar. Outlet setting pressure 3 bar.

R	A	B	C	D	Presión salida / Output pressure	
					Min.	Max.
1/2"	149	17	108	46	0,5	7
3/4"	160	19	111	46	0,5	7
1"	199	24	158	61	0,5	7
1 1/4"	217	30	168	61	0,5	7
1 1/2"	236	37	181	61	0,5	7
2"	269	47	193	61	0,5	7

3324R 04	1/2"	0,598	1-9	58,90
3324R 05	3/4"	0,722	1-9	71,24
3324R 06	1"	-	1-7	107,13
3324R 07	1 1/4"	1,95	1-7	158,05
3324R 08	1 1/2"	2,490	1-4	210,65
3324R 09	2"	3,690	1-4	277,34

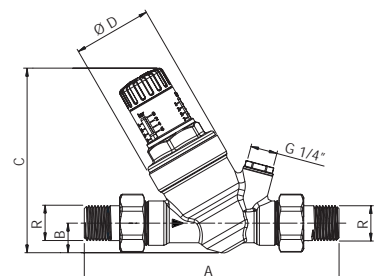

Ref. 3342



Válvula reductora de presión a membrana. Latón DZR

PN 25. Construcción en latón anticorrosión DZR según UNE-EN 12165. Membrana en EPDM reforzada en poliamida. Filtro en acero inox AISI 304, 500 micras. Juntas de EPDM. Muelle de acero galvanizado. Extremos rosca con racores M-M conico s/ EN 10226. Temperatura máx. de trabajo 80°C. Presión máx. de trabajo 25 bar. Campo de regulación 1 a 6 bar. Presión de salida establecida 3 bar.

Membrane pressure reducing valve. DZR brass

PN 25. DZR anticorrosion brass construction UNE-EN 12165. EPDM membrane with polyamide reinforced. Filter stainless steel AISI 304, 500 microns. EPDM joints. Steel galvanized spring. Threaded ends with taper connectors M-M EN 10226. Max. working temp. 80°C. Max. working pressure 25 bar. Adjustable range from 1 to 6 bar. Outlet setting pressure 3 bar.

R	A	B	C	L	Presión salida (bar) / Output pressure (bar)	
					Min.	Max.
1/2"	140	42	149,3	84	1	6
3/4"	160	42	149,3	90	1	6
1"	199	55,2	180,5	100	1	6
1 1/4"	170	55,2	188,4	108	1	6
1 1/2"	199	70	239,3	134	1	6
2"	193	70	245,8	142	1	6

CÓDIGO CODE	MEDIDA SIZE	PESO WEIGHT	CAJA / BOX CARTON	P.V.P. € PRICE €
3342 04	1/2"	0,770	1-18	99,03
3342 05	3/4"	0,970	1-18	107,49
3342 06	1"	1,595	1-12	144,40
3342 07	1 1/4"	1,830	1-12	171,42
3342 08	1 1/2"	3,080	1-1	289,55
3342 09	2"	4,250	1-1	375,20

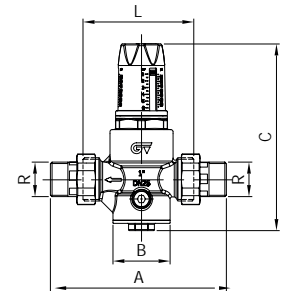

Ref. 3344



Válvula reductora de presión a pistón con bridas

Bridas DIN PN 10/16. Cuerpo aleación de bronce UNI EN 1982. Cierre inox. AISI 303. Juntas tóricas: NBR. Máxima presión de entrada 30 bar. Máx. temperatura de trabajo 80°C. Rango de salida ajustable de 1,5 a 7 bar.

Direct acting piston flanged ends pressure reducing valve

Flanged DIN PN 10/16. Bronze alloy body UNI EN 1982. Sealing inox. AISI 303. O'rings NBR. Maximum inlet pressure 30 bar. Maximum working temperature 80°C. Outlet range: adjustable from 1,5 to 7 bar.

DN	L	H
50	165	250
65	170	260
80	177	270
100	207	320

3344 09	2"	10,700	1-2	1181,14
3344 10	2 1/2"	11,200	1-2	1355,52
3344 11	3"	12,500	1-2	1454,47
3344 12	4"	17,000	-	1990,74

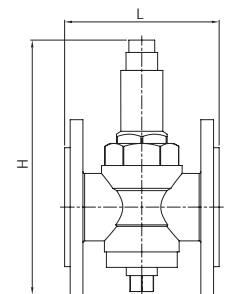

Ref. 2272



Válvula reductora de presión

Construcción: acero inox. CF8M (316) microfusión. Extremos rosca gas ISO 228-1. Asiento y diafragma FPM (Viton). Presión máxima de entrada 25 bar. Presión de salida: 1 - 6 bar (tarado a 3 bar). Temperatura de trabajo: -15°C +120°C.

Stainless steel pressure reducing valve

Construction: stainless steel CF8M (316) investment casting. Gas threaded ends ISO 228-1. Seat and diaphragm in FPM (viton). Maxim input pressure 25 bar.

Outlet pressure: 1 - 6 bar (preset 3 bar). Working temperature: -15°C +120°C.

DN	R	H	L
15	1/2"	100	70
20	3/4"	100	85
25	1"	105	92

2272 04	1/2"	0,780	1-20	157,07
2272 05	3/4"	1,010	1-20	187,80
2272 06	1"	1,160	1-15	268,46

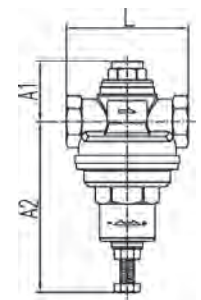

Ref. 39101



Brida roscada PN16

Construcción en acero inox. AISI 304. Extremo rosca macho (ISO 228/1). Aplicación para filtros autolimpiantes y reductoras de presión

Threaded flange PN 16

Stainless steel AISI 304 construction. Thread male end (ISO 228/1). Use mainly for self-cleaning filters and pressure reducing valves

R	A	C	H	D	S	N.º agujeros/ Num. holes
1 1/2"	150	110	46,5	16	3	4
2"	165	125	52,5	16	4	4
2 1/2"	185	145	62,5	18	4	4
3"	200	160	72,5	18	4	8
4"	225	180	83,5	19	5	8

39101 08	1 1/2"	1,000	1	51,42
39101 09	2"	1,000	1	62,78
39101 10	2 1/2"	1,200	1	81,91
39101 11	3"	1,450	1	94,31
39101 12	4"	2,177	1	117,71

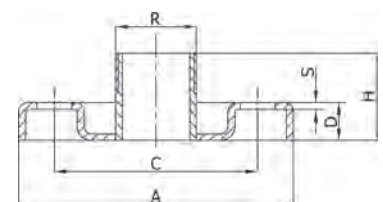

Ref. 3780



Presostato para agua 0-4 bar

Para controlar presión de bombas de agua. Tensión de conexión 230V 50-60 Hz. Potencia máxima conexión 1,5 KW. Presión máxima trabajo 4 bar. Regulación de 0 a 4 bar. Tiempo máximo de maniobras 60 ciclos/min. Diferencial variable.

4 - 10 bar Pressure switch for water

To control pressure of water pumps. Connection voltage 230V 50-60 Hz. Max. connection power 1.5 KW. Max. working pressure 4 bar. Scale from 0 to 4 bar. Max. operating time 60 cycles/min. Variable differential.

CÓDIGO CODE	MEDIDA SIZE	PESO WEIGHT	CAJA / BOX CARTON	P.V.P. € PRICE €
3780 02	1/4"	0,330	1-64	8,19

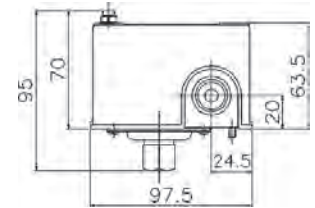

Ref. 3781



Presostato para agua 4 - 10 bar

Para controlar presión de bombas de agua. Tensión de conexión 230V 50-60 Hz. Potencia máxima conexión 1,5 KW. Presión máxima trabajo 10 bar. Regulación de 4 a 10 bar. Tiempo máximo de maniobras 60 ciclos/min. Diferencial variable.

4 - 10 bar Pressure switch for water

To control pressure of water pumps. Connection voltage 230V 50-60 Hz. Max. connection power 1.5 KW. Max. working pressure 10 bar. Scale from 4 to 10 bar. Max. operating time 60 cycles/min. Variable differential.

3781 02	1/4"	0,350	1-64	11,06
---------	------	-------	------	-------

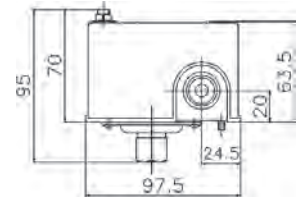

Ref. 3784



Presostato 1 vía para aire

Para controlar presión de compresores. Tensión de conexión 240V 50-60 Hz. Potencia máxima conexión 2,2 KW. Presión máxima trabajo 12 bar. Regulación de 1,5 a 12 bar. Diferencial variable. Rosca 1/4" NPT. Válvula de descarga incorporada. Función desconexión manual.

1 way pressure switch for air

To control pressure of air pumps. Connection voltage 240V 50-60 Hz. Max. connection power 2.2 KW. Max. working pressure 12 bar. Scale from 1.5 to 12 bar. Variable differential. NPT 1/4" thread. Discharge valve incorporated. Manual disconnection function.

3784 02	1/4" NPT	0,370	1-60	18,61
---------	----------	-------	------	-------

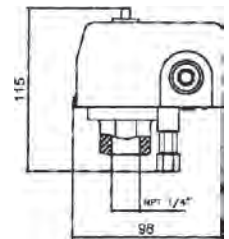

Ref. 3785



Presostato 4 vías para aire

Para controlar presión de compresores. Tensión de conexión 240V 50-60 Hz. Potencia máxima conexión 2,2 KW. Presión máxima trabajo 12 bar. Regulación de 1,5 a 12 bar. Diferencial variable. Rosca 1/4" NPT. Válvula de descarga incorporada. Función desconexión manual.

4 ways pressure switch for air

To control pressure of air pumps. Connection voltage 240V 50-60 Hz. Max. connection power 2.2 KW. Max. working pressure 12 bar. Scale from 1.5 to 12 bar. Variable differential. NPT 1/4" thread. Discharge valve incorporated. Manual disconnection function.

3785 02	1/4" NPT	0,387	1-60	19,22
---------	----------	-------	------	-------

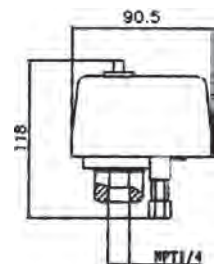

Ref. 3880

Interruptor de nivel vertical

Tensión de conexión 110-220V / 50-60 HZ. Potencia máxima de conexión 1,5 KW. Temp. máx. ambiente 80°C.

Vertical level switch

Connection voltage 110-220V / 50-60 HZ. Max. connection power 1.5 KW. Max. ambient temp. 80°C.



CÓDIGO CODE	MEDIDA SIZE	PESO WEIGHT	CAJA / BOX CARTON	P.V.P. € PRICE €
3880 00	-	0,150	1-24	12,72

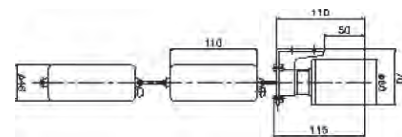

Ref. 3881

Interruptor de nivel horizontal para vaciado

Tensión de conexión 110-220V / 50-60 Hz. Potencia máxima de conexión 1,5Kw. Temp. máx. funcionamiento 50°C. Protección IP68. Código 3881 040 con longitud de cable 40cm. Código 3881 300 con longitud de cable 300cm.

Horizontal level switch for emptying

Supply voltage 110-220V / 50-60 Hz. Max. connection power 1.5 Kw. Max. operating temp 50°C. Protection IP68. Code 3881 040 with 40cm wire. Code 3881 300 with 300cm wire.



3881 040	40 cm	0,194	1-24	12,21
3881 300	300cm	0,519	1-24	14,82

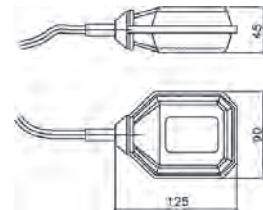

Ref. 3882

Contrapeso

Montable en el interruptor de nivel horizontal para la regulación de niveles. Temperatura máxima 50°C. Apto para cables hasta Ø 10 mm.

Counterweight

Assembling in the horizontal level switch - to regulate levels. Max. operating temp. 50°C suitable for cables until Ø 10 mm.



3882 00	-	0,236	1-100	2,19
---------	---	-------	-------	------

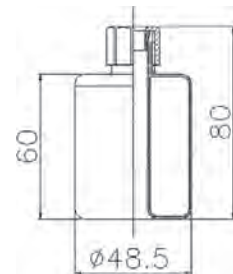

Ref. 3883

Interruptor de nivel horizontal conmutable

Tensión de conexión 110-220V / 50-60 Hz. Potencia máxima de conexión 1,5Kw. Temp. máx. funcionamiento 50°C. Protección IP68. Contrapeso incluido.

Código 3883 300 con longitud de cable 300cm. Código 3883 500 con longitud de cable 500cm.

Commutable horizontal level switch

Supply voltage 110-220V / 50-60 Hz. Max. connection power 1.5 Kw. Max. operating temp 50°C. Protection IP68. Counterweight included. Code 3883 300 with 300cm wire. Code 3883 500 with 500cm wire.



3883 300	300	0,800	1-22	18,30
3883 500	500	0,980	1-20	22,83

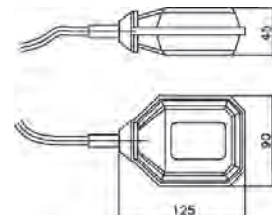

Ref. 3884

Controlador de volumen de aire

Construcción en acero al carbono zincado Q235 resistente al choque térmico. Membrana en polipropileno. Extremos roscados NPT 3/8" x 7/16" - 24. Para volúmenes de depósitos de 45 y 100 galones. Máx. temp. trabajo 60°C. Máx. presión trabajo 150 psi (10 bar).

Air volume control

Zinc plated carbon steel Q235A shock therm resistant construction. Polypropylene membrane. Threaded ends NPT 3/8" x 7/16" - 24. Available for tanks volume of 45 and 100 gallons. Max. working temp. 60°C. Max. working pressure: 150 psi (10 bar).



Ø D	H
104	92

3884 00	NPT 3/8" x 7/16" - 24	0,265	1-48	9,71
---------	-----------------------	-------	------	------

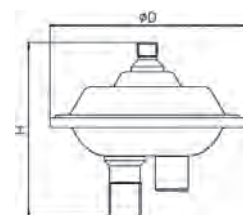

Ref. 3884



Controlador de volumen de aire

Construcción en aleación de zinc (Zamac). Membrana en EPDM. Conexiones roscadas hembra NPT 1/4" x NPT 3/8". Para volúmenes de depósitos de 120 galones. Máx. temp. trabajo 60°C. Máx. presión trabajo 150 psi.

Air volume control

Zinc alloy (Zamac) construction. EPDM membrane. Female threaded connections NPT 1/4" x NPT 3/8". Available for tanks volume of 120 gallons. Max. working temp. 60°C. Max. working pressure: 150 psi.

CÓDIGO CODE	MEDIDA SIZE	PESO WEIGHT	CAJA / BOX CARTON	P.V.P. € PRICE €
----------------	----------------	----------------	----------------------	---------------------

3884 120	NPT 1/4" x NPT 3/8"	0,839	1-20	42,92
----------	---------------------	-------	------	-------

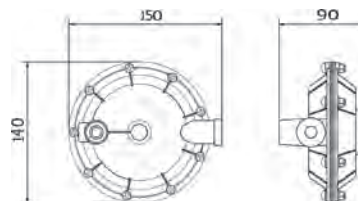

Ref. 3886

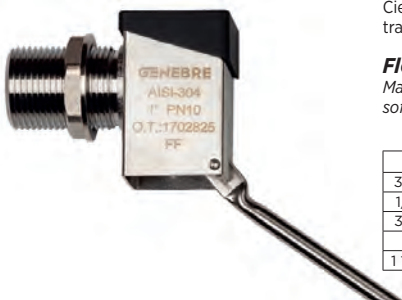

Válvula de flotador sin boya

Construcción en acero inoxidable AISI 304. Conexión rosca gas. Paso total. Cierre de silicona progresivo. Presión de trabajo máxima 10 BAR. Máx. temp. trabajo 150°.

Floating valve without buoy

Made of stainless steel AISI 304. Connection gas threaded. Full port. Silicone soft sealing. Max. working pressure 10 BAR. Máx working temp. 150°.

R	L	A
3/8"	300	32
1/2"	410	35
3/4"	500	42
1"	580	45
1 1/4"	580	52

3886 03	3/8"	0,010	10 *-20	17,64
3886 04	1/2"	0,182	10 *-20	18,96
3886 05	3/4"	0,294	10 *-15	32,54
3886 06	1"	0,371	5 *-10	35,03
3886 07	1 1/4"	0,440	5 *-10	40,44

* Cantidad mínima de venta / * Minimum sale quantity

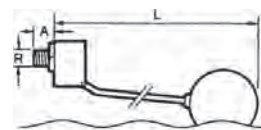

Ref. 3887



Boya para flotador

Construcción en acero inoxidable AISI 304.

Buoy for floating valves

Made of stainless steel AISI 304.

R	D	M
3/8"	90	M-6
1/2"	110	M-6
3/4"	160	M-8
1"	160	M-8
1 1/4"	160	M-8

3887 090	Ø 90 mm	0,066	1-48	13,73
3887 110	Ø 110 mm	0,100	1-27	16,20
3887 160	Ø 160 mm	0,340	1-8	35,26

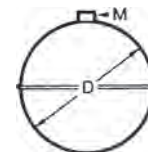

Ref. 2848



Controlador de flujo (líquidos)

Caja aleación aluminio. Racor latón. Lengüetas en acero inox. Para tuberías de 1" a 8". Conexión rosca 1" ISO 7/1 (EN 10226-1). Temp. máx. 110°C. Presión máx. 10 bar. 250V - 10A. Protección IP-64.

Liquid flow switch

Aluminium alloyed box. Brass connector. Blade: stainless steel for pipe from 1" to 8". Threaded connection 1" ISO 7/1 (EN 10226-1). Max. temp. 110°C. Max. pressure 10 bar. 250V - 10A. Protection IP-64.

2848 06	1"	0,625	1-10	74,97
---------	----	-------	------	-------

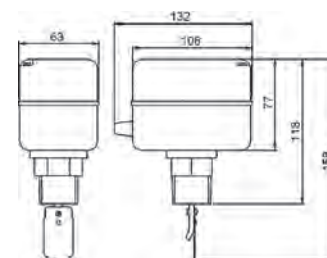

Ref. 2850



Controlador de flujo (líquidos)

Caja acero pintado - racor latón. Lengüetas en acero inox. Para tuberías de 1" a 8". Conexión rosca 1" ISO 7/1 (EN 10226-1). Temp. máx. 110°C. Presión máx. 10 bar. 250V - 10A. Protección IP-54.

Liquid flow switch

Coated steel box. Brass connector. Blade: stainless steel for pipe from 1" to 8". Threaded connection 1" ISO 7/1 (EN 10226-1). Max. temp. 110°C. Max. pressure 10 bar. 250V - 10A. Protection: IP 54.

2850 06	1"	0,650	1-10	66,19
---------	----	-------	------	-------

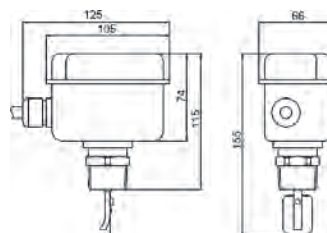

Ref. 3250



Controlador automático de bombas de agua. Potencia 3 CV

Para activar/desactivar el funcionamiento de una bomba en instalaciones y suministros. Tensión de conexión 220V-240V 50-60Hz. Intensidad máx. 30(16)A. Presión de arranque de bomba 1,5 bar y 2,2 bar. Máx. potencia 3 CV. Presión de trabajo 10 bar. Máx. temp. trabajo 60°C. Protección IP 65.

Automatic water pump control. 3HP

To power on/off pump operation for installations and supply. Connection voltage 220V-240V 50-60Hz. Max. current 30(16)A. Start pressure 1,5 bar and 2,2 bar. Horse power 3 Hp. Max. working pressure 10 bar. Max. working temp. 60°C. IP 65.

CÓDIGO CODE	MEDIDA SIZE	PESO WEIGHT	CAJA / BOX CARTON	P.V.P. € PRICE €
-------------	-------------	-------------	-------------------	------------------

3250 01	1 1/4" 1,5 BAR	1,485	1-8	179,21
3250 02	1 1/4" 2,2 BAR	-	1-8	184,49

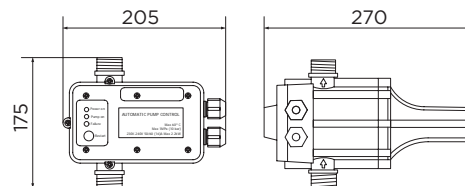

Ref. 3253



Controlador automático de bombas de agua. Potencia 1,5CV

Para activar/desactivar el funcionamiento de una bomba en instalaciones y suministros. Tensión de conexión 110V-220V 50-60Hz. Intensidad máx. 10(6)A. Presión de arranque ajustable entre 1,5- 3 bar. Potencia 1,5 CV. Máx. presión de trabajo 10 bar. Máx. temp. trabajo 60°C. Protección IP 65. Manómetro 0-10 bar incorporado.

Automatic water pump control. 1,5HP

To power on/off pump operation for installations and supply. Connection voltage 110V-220V 50-60Hz. Max. current 10(6)A. Start adjustable pressure 1,5- 3 bar. Horse power 1,5 Hp. Max. working pressure 10 bar. Max. working temp. 60°C. IP 65. Pressure gauge 0-10 bar incorporated.

3253	1" x 1"	1,063	1-16	61,22
------	---------	-------	------	-------

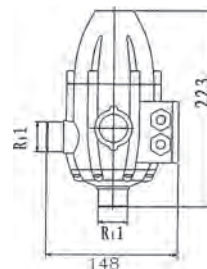

Ref. 3254



Controlador automático de bombas de agua. Potencia 1,5 CV

Para activar/desactivar el funcionamiento de una bomba en instalaciones y suministros. Tensión de conexión 220V-240V 50/60 Hz. Intensidad máx. 10(6)A. Presión de arranque/paro de bomba 1,5 bar. Potencia 1,5 CV. Máx. presión de trabajo 10 bar. Máx. temp. trabajo 60°C. Protección IP 65.

Automatic water pump control. 1,5 HP

To power on/off pump operation for installations and supply. Connection voltage 220V-240V 50/60 Hz. Max. current 10(6)A. Start/Stop pressure 1,5 bar. Horse power 1,5 Hp. Max. working pressure 10 bar. Max. working temp. 60°C. IP 65.

3254	1" x 1"	1,1	1-12	61,22
------	---------	-----	------	-------

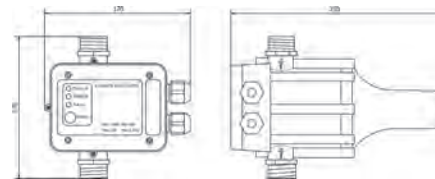

Ref. 3264



Controlador automático de bombas de agua. Potencia 1 CV

Para activar/desactivar el funcionamiento de una bomba en instalaciones y suministros. Tensión de conexión 110V-120V 50/60 Hz. Intensidad máx. 10(6)A. Presión de arranque/paro de bomba 1,5 bar. Potencia 1 CV. Máx. presión de trabajo 10 bar. Máx. temp. trabajo 60°C. Protección IP 65.

Automatic water pump control. 1 HP

To power on/off pump operation for installations and supply. Connection voltage 110V-120V 50/60 Hz. Max. current 10(6)A. Start/Stop pressure 1,5 bar. Horse power 1 Hp. Max. working pressure 10 bar. Max. working temp. 60°C. IP 65.

3264	1" x 1"	1,12	1-12	63,06
------	---------	------	------	-------

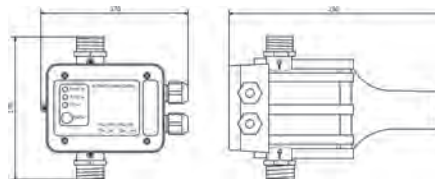

Ref. 3840

NEW

Manómetro Ø50, salida radial, rosca NPT

Caja ABS. Tubo bourdon y racor según latón UNE EN 12165. Rosca 1/4" macho NPT. Graduación disponible 0-6 bar (salida inferior) y 0-250 bar (salida lateral). Clase de precisión 1.6.

Pressure gauge Ø50, radial connection, NPT thread

ABS case. Brass bourdon pipe and connector UNE-EN 12165. 1/4" male gas threaded (BSP). Scale available 0-6 bar (bottom connection) and 0-250 bar (lateral connection). Precision class 1.6.

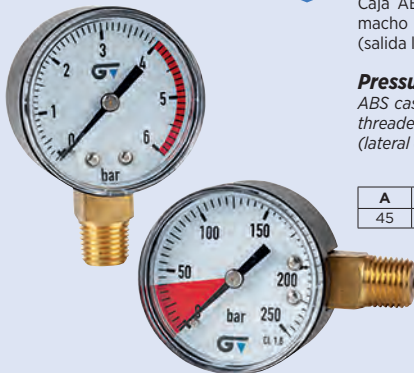

A	L	D
45	50	27

CÓDIGO CODE	BAR	PSI	PESO WEIGHT	CAJA / BOX CARTON	P.V.P. € PRICE €
-------------	-----	-----	-------------	-------------------	------------------

3840 006	0-6	-	0,056	1	4,47
3840 250	0-250	-	0,062	1	4,99

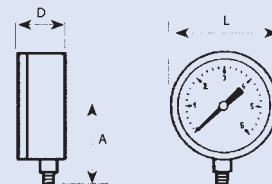

Ref. 3809

NEW

Termomanómetro Ø80 Salida posterior.

Caja de acero pintada. Tubo Bourdon y rosca de latón según UNE-EN 12165. Rosca R1/2" macho ISO 7/1 (UNE-EN 10226). Rango de presión 0 - 6 bar. Clase de precisión 2,5. Termómetro bimetalico. Rango de temperatura 20 a 120°C.

Thermomanometer Ø80, back connection

Steel case. Brass bourdon pipe and connector UNE-EN 12165. 1/2" male gas threaded (BSP) ISO 7/1 (UNE-EN 10226). Scale 0-6 bar. Precision class 2,5. Bimetallic thermometer. Temperature range 20 to 120°C.



A	70
L	83
D	30
e/c	21
R	R 1/2"

3809 006	0-6	-	0,19	1	26,39
----------	-----	---	------	---	-------

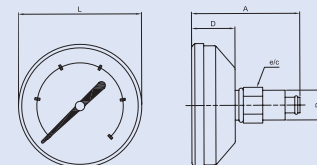

Ref. 3802

Manómetro Ø 40, salida posterior, rosca BSP

Caja ABS. Tubo bourdon y racor latón UNE-EN 12165. Rosca 1/8" macho gas (BSP). Graduaciones disponibles 0 a 2,5-4-6-10-16-25 bar. Salida posterior. Clase de precisión 2,5.

Pressure gauge Ø 40, back connection, BSP thread

ABS case. Brass bourdon pipe and connector UNE-EN 12165. 1/8" male gas threaded (BSP). Scale available from 0 to 2,5-4-6-10-16-25 bar. Back connection. Precision class 2,5.



A	L	D
39	40	25

3802 006	0-6	0-80	0,036	1-240	4,11
3802 010	0-10	0-140	0,036	1-240	4,11

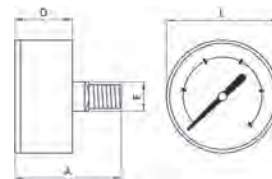

Ref. 3819

Manómetro Ø 53 indicador rojo, salida inferior

Caja ABS. Tubo bourdon y racor latón UNE-EN 12165. Rosca 1/4" macho gas (BSP). Graduaciones disponibles 0 a 2,5-4-6-10-16-25 bar. Salida inferior (radial). Clase de precisión 2,5.

Pressure gauge Ø 53, red index, bottom connection

ABS case. Brass bourdon pipe and connector UNE-EN 12165. 1/4" male gas threaded (BSP). Scale available from 0-2,5-4-6-10-16-25 bar. Bottom connection (radial). Precision class 2,5.



A	L	D
46	53	27

3819 002	0-2,5	0-40	0,071	1-280	5,40
3819 004	0-4	0-60	0,071	1-280	5,40
3819 006	0-6	0-90	0,071	1-280	5,40
3819 010	0-10	0-150	0,071	1-280	5,40
3819 016	0-16	0-240	0,071	1-280	5,40
3819 025	0-25	0-400	0,071	1-280	5,40

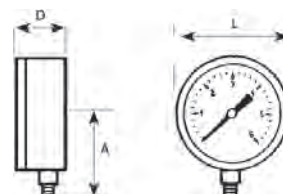

Ref. 3818



Manómetro Ø 53 indicador rojo, salida posterior

Caja ABS. Tubo bourdon y racor latón UNE-EN 12165. Rosca 1/4" macho gas (BSP). Graduaciones disponibles 0 a 2,5-4-6-10-16-25 bar. Salida posterior. Clase de precisión 2,5.

Pressure gauge Ø 53, red index, back connection

ABS case. Brass bourdon pipe and connector UNE-EN 12165. 1/4" male gas threaded (BSP). Scale available from 0-2.5-4-6-10-16-25 bar. Back connection. Precision class 2.5.

A	L	D
48	53	27

CÓDIGO CODE	BAR	PSI	PESO WEIGHT	CAJA / BOX CARTON	P.V.P. € PRICE €
3818 002	0-2,5	0-40	0,066	1-210	5,61
3818 004	0-4	0-60	0,066	1-210	5,61
3818 006	0-6	0-90	0,066	1-210	5,61
3818 010	0-10	0-150	0,066	1-210	5,61
3818 016	0-16	0-240	0,066	1-210	5,61
3818 025	0-25	0-400	0,066	1-210	5,61

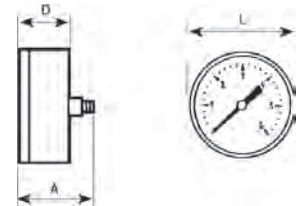

Ref. 3820



Manómetro Ø 53, salida inferior, rosca BSP

Caja ABS. Tubo bourdon y racor latón UNE-EN 12165. Rosca 1/4" macho gas (BSP). Graduaciones disponibles 0 a 2,5-4-6-10-16-25 bar. Salida inferior (radial). Clase de precisión 2,5.

Pressure gauge Ø 53, bottom connection, BSP thread

ABS case. Brass bourdon pipe and connector UNE-EN 12165. 1/4" male gas threaded (BSP). Scale available from 0-2.5-4-6-10-16-25 bar. Bottom connection (radial). Precision class 2.5.

A	L	D
47	53	27

3820 002	0-2,5	0-40	0,064	1-280	5,06
3820 004	0-4	0-60	0,064	1-280	5,06
3820 006	0-6	0-90	0,064	1-280	5,06
3820 010	0-10	0-150	0,064	1-280	5,06
3820 016	0-16	0-240	0,064	1-280	5,06
3820 025	0-25	0-400	0,064	1-280	5,06

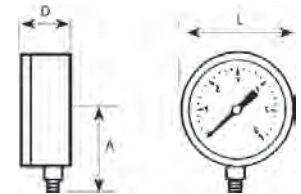

Ref. 3820N



Manómetro Ø 53, salida inferior, rosca NPT

Caja ABS. Tubo bourdon y racor latón UNE-EN 12165. Rosca 1/4" macho (NPT). Graduaciones disponibles 0 a 2,5-4-6-10-16-25 bar. Salida inferior (radial). Clase de precisión 2,5.

Pressure gauge Ø 53, bottom connection, NPT thread

ABS case. Brass bourdon pipe and connector UNE-EN 12165. 1/4" male threaded (NPT). Scale available from 0-2.5-4-6-10-16-25 bar. Bottom connection (radial). Precision class 2.5.

Several scales available

A	L	D
47	53	27

3820N 002	0-2,5	0-40	0,064	1-280	5,18
3820N 004	0-4	0-60	0,064	1-280	5,18
3820N 006	0-6	0-90	0,064	1-280	5,18
3820N 010	0-10	0-150	0,064	1-280	5,18
3820N 016	0-16	0-240	0,064	1-280	5,18
3820N 025	0-25	0-400	0,064	1-280	5,18

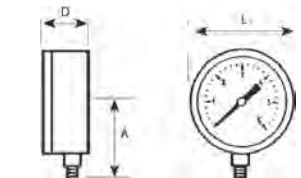

Ref. 3821



Manómetro Ø 53, salida posterior, rosca BSP

Caja ABS. Tubo bourdon y racor latón UNE-EN 12165. Rosca 1/4" macho gas (BSP). Graduaciones disponibles 0 a 2,5-4-6-10-16-25 bar. Salida posterior. Clase de precisión 2,5.

Pressure gauge Ø 53, back connection, BSP thread

ABS case. Brass bourdon pipe and connector UNE-EN 12165. 1/4" male gas threaded (BSP). Scale available from 0-2.5-4-6-10-16-25 bar. Back connection. Precision class 2.5.

A	L	D
48	53	27

3821 002	0-2,5	0-40	0,068	1-210	5,40
3821 004	0-4	0-60	0,068	1-210	5,40
3821 006	0-6	0-90	0,068	1-210	5,40
3821 010	0-10	0-150	0,068	1-210	5,40
3821 016	0-16	0-240	0,068	1-210	5,40
3821 025	0-25	0-400	0,068	1-210	5,40

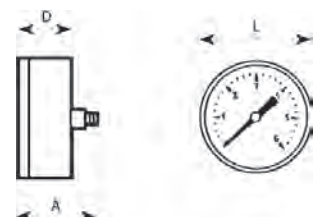

Ref. 3825



Manómetro Ø 63, indicador rojo, salida inferior

Caja ABS. Tubo bourdon y racor latón UNE-EN 12165. Rosca 1/4" macho gas (BSP). Graduaciones disponibles 0 a 2,5-4-6-10-16-25 bar. Salida inferior (radial). Clase de precisión 2,5.

Pressure gauge Ø 63, red index, bottom connection

ABS case. Brass bourdon pipe and connector UNE-EN 12165. 1/4" male gas threaded (BSP). Scale available from 0-2.5-4-6-10-16-25 bar. Bottom connection (radial). Precision class 2.5.

A	L	D
50	63	28

CÓDIGO CODE	BAR	PSI	PESO WEIGHT	CAJA / BOX CARTON	P.V.P. € PRICE €
3825 002	0-2,5	0-40	0,075	1-180	5,52
3825 004	0-4	0-60	0,075	1-180	5,52
3825 006	0-6	0-90	0,075	1-180	5,52
3825 010	0-10	0-150	0,075	1-180	5,52
3825 016	0-16	0-240	0,075	1-180	5,52
3825 025	0-25	0-400	0,075	1-180	5,52

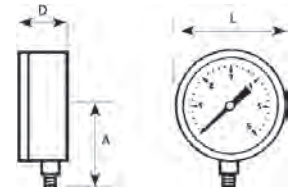

Ref. 3826



Manómetro Ø 63, indicador rojo, salida posterior

Caja ABS. Tubo bourdon y racor latón UNE-EN 12165. Rosca 1/4" macho gas (BSP). Graduaciones disponibles 0 a 2,5-4-6-10-16-25 bar. Salida posterior. Clase de precisión 2,5.

Pressure gauge Ø 63, red index, back connection

ABS case. Brass bourdon pipe and connector UNE-EN 12165. 1/4" male gas threaded (BSP). Scale available from 0-2.5-4-6-10-16-25 bar. Back connection (radial). Precision class 2.5.

A	L	D
49	63	29

3826 002	0-2,5	0-40	0,084	1-75	5,78
3826 004	0-4	0-60	0,084	1-132	5,78
3826 006	0-6	0-90	0,084	1-132	5,78
3826 010	0-10	0-150	0,084	1-132	5,78
3826 016	0-16	0-240	0,084	1-75	5,78
3826 025	0-25	0-400	0,084	1-132	5,78

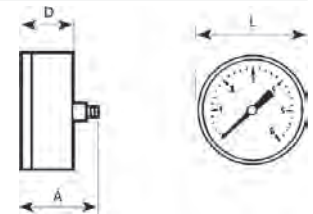

Ref. 3822



Manómetro Ø 63 con glicerina, salida inferior, rosca BSP

Caja acero inox. AISI 304. Tubo bourdon y racor latón UNE-EN 12165. Rosca 1/4" macho gas (BSP). Graduaciones disponibles 0 a 2,5-4-6-10-16-25-60-100 bar. Salida inferior (radial). Clase de precisión 2,5.

Pressure gauge Ø 63 with glycerine, bottom connection, BSP thread

Stainless steel AISI 304 case. Brass bourdon pipe and connector UNE-EN 12165. 1/4" male gas threaded (BSP). Scale available from 0-2.5-4-6-10-16-25-60-100 bar. Bottom connection (radial). Precision class 2.5.

A	L	D
55	63	30

3822 002	0-2,5	0-40	0,180	1-160	12,42
3822 004	0-4	0-60	0,180	1-160	12,42
3822 006	0-6	0-90	0,180	1-160	12,42
3822 010	0-10	0-150	0,180	1-160	12,42
3822 016	0-16	0-240	0,180	1-160	12,42
3822 025	0-25	0-400	0,180	1-160	12,42
3822 060	0-60	0-900	0,180	1-160	12,42
3822 100	0-100	0-1500	0,180	1-160	12,42

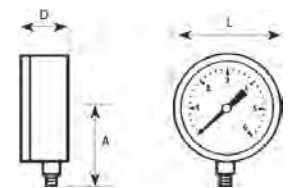

Ref. 3822N



Manómetro Ø 63 con glicerina, salida inferior, rosca NPT

Caja acero inox. AISI 304. Tubo bourdon y racor latón UNE-EN 12165. Rosca 1/4" macho (NPT). Graduaciones disponibles 0 a 2,5-4-6-10-16-25-60-100 bar. Salida inferior (radial). Clase de precisión 2,5.

Pressure gauge Ø 63 with glycerine, bottom connection, NPT thread

Stainless steel AISI 304 case. Brass bourdon pipe and connector UNE-EN 12165. 1/4" male threaded (NPT). Scale available from 0-2.5-4-6-10-16-25-60-100 bar. Bottom connection (radial). Precision class 2.5.

Several scales available

A	L	D
55	63	30

3822N 002	0-2,5	0-40	0,185	1-160	13,06
3822N 004	0-4	0-60	0,185	1-160	13,06
3822N 006	0-6	0-90	0,185	1-160	13,06
3822N 010	0-10	0-150	0,185	1-160	13,06
3822N 016	0-16	0-240	0,185	1-160	13,06
3822N 025	0-25	0-400	0,185	1-160	13,06
3822N 060	0-60	0-900	0,185	1-160	13,06
3822N 100	0-100	0-1500	0,185	1-160	13,06

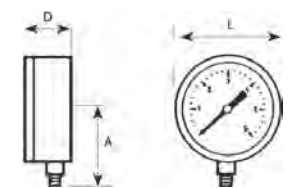

Ref. 3829



Manómetro Ø 63 con glicerina, salida posterior, rosca BSP

Caja acero inox. AISI 304. Tubo bourdon y racor latón UNE-EN 12165. Rosca 1/4" macho gas (BSP). Graduaciones disponibles 0 a 2,5-4-6-10-16-25-60-100 bar. Salida posterior. Clase de precisión 2,5.

Pressure gauge Ø 63 with glycerine, back connection, BSP thread

Stainless steel AISI 304 case. Brass bourdon pipe and connector UNE-EN 12165. 1/4" male gas threaded (BSP). Scale available from 0-2,5-4-6-10-16-25-60-100 bar. Back connection. Precision class 2,5.

A	L	D
48	63	27

CÓDIGO CODE	BAR	PSI	PESO WEIGHT	CAJA / BOX CARTON	P.V.P. € PRICE €
3829 002	0-2,5	0-40	0,184	1-60	13,06
3829 004	0-4	0-60	0,225	1-60	13,06
3829 006	0-6	0-90	0,184	1-60	13,06
3829 010	0-10	0-150	0,184	1-60	13,06
3829 016	0-16	0-240	0,184	1-60	13,06
3829 025	0-25	0-400	0,184	1-60	13,06
3829 060	0-60	0-900	0,184	1-60	13,06
3829 100	0-100	0-1500	0,184	1-60	13,06

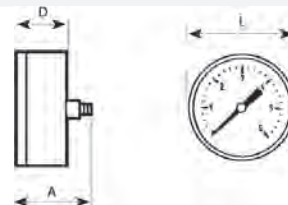

Ref. 3814



Manómetro Ø 63 con glicerina, salida inferior, rosca BSP

Caja acero inox AISI 304. Tubo bourdon y racor en acero inox. AISI 304. Rosca 1/4" macho gas (BSP). Graduaciones disponibles 0 a 2,5-4-6-10-16-25-40-60-100 bar. Salida inferior (radial). Clase de precisión 2,5.

Pressure gauge Ø 63 with glycerine, bottom connection, BSP thread

Stainless steel AISI 304 case - bourdon pipe and connector. 1/4" male gas threaded (BSP). Scale available from 0-2,5-4-6-10-16-25-40-60-100 bar. Bottom connection (radial). Precision class 2,5.

A	L	D
56	63	30

3814 002	0-2,5	0-40	0,207	1-160	27,99
3814 004	0-4	0-60	0,207	1-160	27,99
3814 006	0-6	0-90	0,207	1-160	27,99
3814 010	0-10	0-150	0,207	1-160	27,99
3814 016	0-16	0-240	0,207	1-160	27,99
3814 025	0-25	0-400	0,207	1-160	27,99
3814 040	0-40	0-600	0,207	1-160	27,99
3814 060	0-60	0-900	0,207	1-160	27,99
3814 100	0-100	0-1500	0,207	1-160	27,99

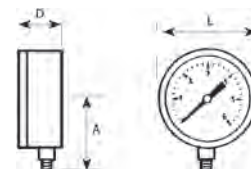

Ref. 3714



Manómetro Ø 63 mm, salida inferior, rosca NPT

2, psi.

Pressure gauge Ø 63 mm, bottom connection, NPT thread

2, psi scale.

A	L	D
51	63	30

3714 004	0-4	0-60	0,092	1-200	5,61
3714 007	0-7	0-100	0,092	1-200	5,61
3714 010	0-10	0-150	0,092	1-200	5,61
3714 014	0-14	0-200	0,092	1-200	5,61
3714 017	0-17	0-250	0,092	1-200	5,61
3714 021	0-21	0-300	0,092	1-200	5,61
3714 028	0-28	0-400	0,092	1-200	5,61

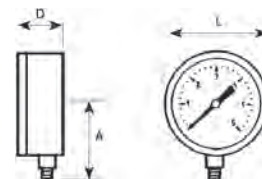

Ref. 3827



Manómetro Ø 80 mm, indicador rojo, salida inferior, rosca BSP

Caja ABS, índice rojo, doble escala. Tubo Bourdon y racor en latón UNE-EN 12165. Rosca 3/8" macho gas (BSP). Graduaciones disponibles 0 a 2,5-4-6-10-16-25-40 bar. Salida inferior. Clase de precisión 2,5.

Pressure gauge Ø 80 mm, red index, bottom connection, BSP thread

ABS Case, red index, double scale. Bourdon pipe and connector 3/8" male gas threaded (BSP). Scale available from 0-2,5-4-6-10-16-25-40 bar. Bottom connection (radial). Precision class 2,5.

A	L	D
70	80	32

3827 002	0-2,5	0-40	0,130	1-100	8,62
3827 004	0-4	0-60	0,130	1-100	8,62
3827 006	0-6	0-90	0,130	1-100	8,62
3827 010	0-10	0-150	0,130	1-100	8,62
3827 016	0-16	0-240	0,130	1-100	8,62
3827 025	0-25	0-400	0,130	1-100	8,62
3827 040	0-40	0-600	0,001	1-100	8,62

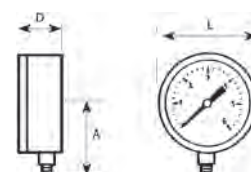

Ref. 3824



Manómetro Ø 100 con glicerina, salida inferior, rosca BSP

Caja acero inox AISI 304, tubo bourdon y racor en acero inox. AISI 304. Rosca 1/2" macho gas (BSP). Graduaciones disponibles 0 a 2,5-4-6-10-16-25-40-60-100 bar. Salida inferior (radial). Clase de precisión 1,6.

Pressure gauge Ø 100 with glycerine, bottom connection, BSP thread

Stainless steel AISI 304 case, bourdon pipe and connector. 1/2" male gas threaded (BSP). Scale available from 0-2,5-4-6-10-16-25-40-60-100 bar. Bottom connection (radial). Precision class 1,6.

A	L	D
85	100	36

CÓDIGO CODE	BAR	PSI	PESO WEIGHT	CAJA / BOX CARTON	P.V.P. € PRICE €
3824 002	0-2,5	0-40	0,561	1-44	44,62
3824 004	0-4	0-60	0,561	1-44	44,62
3824 006	0-6	0-90	0,561	1-44	44,62
3824 010	0-10	0-150	0,561	1-44	44,62
3824 016	0-16	0-240	0,561	1-44	44,62
3824 025	0-25	0-400	0,561	1-44	44,62
3824 040	0-40	0-600	0,561	1-44	44,62
3824 060	0-60	0-900	0,561	1-44	44,62
3824 100	0-100	0-1500	0,561	1-44	44,62

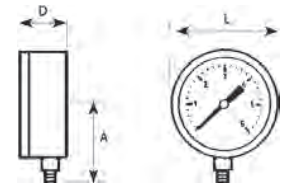

Ref. 3824N



Manómetro Ø 100 con glicerina, salida inferior, rosca NPT

Caja acero inox AISI 304, tubo Bourdon y racor en acero inox. AISI 304. Rosca 1/2" macho (NPT). Graduaciones disponibles 0 a 4-6-10-16-25-40 bar. Salida inferior (radial). Clase de precisión 1,6.

Pressure gauge Ø 100 with glycerine, bottom connection, NPT thread

Stainless steel AISI 304 case, Bourdon pipe and connector. 1/2" male threaded (NPT). Scale available from 0-4-6-10-16-25-40-60-100 bar. Bottom connection (radial). Precision class 1,6.

A	L	D
85	100	36

CÓDIGO CODE	BAR	PSI	PESO WEIGHT	CAJA / BOX CARTON	P.V.P. € PRICE €
3824N 004	0-4	0-60	0,585	1-44	48,26
3824N 006	0-6	0-90	0,520	1-44	48,26
3824N 010	0-10	0-150	0,520	1-44	48,26
3824N 016	0-16	0-240	0,520	1-44	48,26
3824N 025	0-25	0-400	0,585	1-44	48,26
3824N 040	0-40	0-600	0,520	1-44	48,26

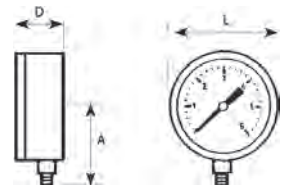

Ref. 3950 - 3952 - 3955



3950 - Cinta "PTFE"

12 m de longitud 0,075 mm de espesor, 12 mm de ancho 0,35 g/cm³ de densidad.

3950 - "PTFE" tape

12 m length 0.075 mm thickness, 12 mm width 0.35 g/cm³ density.

3952 - Cinta "PTFE"

12 m de longitud 0,060 mm de espesor 12 mm de ancho 0,26 g/cm³ de densidad.

3952 - "PTFE" tape

12 m length 0.060 mm thickness, 12 mm width 0.26 g/cm³ density.

3955 - Cinta "PTFE"

50 m de longitud 0,1 mm de espesor, 19 mm de ancho 0,54 g/cm³ de densidad.

3955 - "PTFE" tape

50 m length 0.1 mm thickness, 19 mm width 0.54 g/cm³ density.

CÓDIGO CODE	MEDIDA SIZE	PESO WEIGHT	CAJA / BOX CARTON	P.V.P. € PRICE €
3950 00	0,075 x 12	0,008	100-1000	0,52
3952 00	0,060 x 12	0,006	100-1000	0,37
3955 00	0,1 x 19	0,071	25-200	5,82

Ref. 3956



PTFE líquido 50 ml

Adhesivo anaeróbico para sellar conexiones roscadas metálicas. Resistente a golpes y vibraciones. Temperaturas desde -55°C a +150°C. Fácil desmontaje de piezas selladas.

Liquid "PTFE" 50 ml

Anaerobic adhesive for sealing metal thread pipe joints. Shocks and vibrations resistant. Temperatures from -55°C to +150°C. Easy dismantling of sealed joints.

3956 00	50 ml	0,070	10-50	12,89
---------	-------	-------	-------	-------

VÁLVULAS ANTIFRAUDE / ANTI FRAUD VALVES

SERVICIOS DE AGUA

El sistema GE-Block patentado por Genebre, diseñado para nuestra gama de válvulas antifraude, permite mediante una llave especial, bloquear la válvula en posición de abrir/cerrar, cierre y 10% del caudal nominal.

Dirigido a empresas proveedoras de las compañías de distribución de agua de cada país.

WATERWORKS

GE-Block system patented by Genebre, designed for our anti-fraud valves let by means and special key, block the valve in open/close, close and 10% open positions.

This valve system is intended for valve and pipe suppliers for water supply companies from every country.



FUNCIONAMIENTO VÁLVULAS WATERWORKS - SISTEMA ANTIFRAUDE FUNCTION WATERWORKS VALVE - ANTIFRAUD SYSTEM

Las válvulas waterworks trabajan en 4 posibles posiciones:
The waterworks valve work in 4 possible positions:



A
Función normal Abrir / Cerrar manualmente (O ↔ C)
Normal function Open / Close manually (O ↔ C)

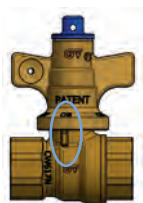

B
Bloqueo en posición Abierta (OB)
Lock in Open position (OB)



C
Bloqueo en posición Cerrada (CB)
Lock in Close position (CB)



D
Bloqueo en 10% de apertura (10%)
Lock in 10% opening (10%)

Estas 4 posibles posiciones se consiguen girando el accionamiento a un punto determinado mediante una llave especial. Se debe hacer coincidir la marca del accionamiento con el tope del cuerpo. These four possible positions are achieved by rotating the handle to a determinate point by a special key. It must match the handle's mark with the body's stop.

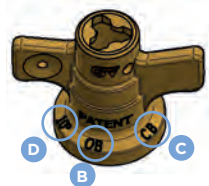

- D** Bloqueo en 10% de apertura
Lock in 10% opening
- B** Bloqueo en posición Abierta
Lock in Open position
- C** Bloqueo en posición Cerrada
Lock in Close position



Tope del cuerpo
Body's stop

Procedimiento de cambio de posición y bloqueo (Ejemplo de función normal Abrir / Cerrar manualmente a Bloqueo en 10% apertura):
Procedure for changing the position and blocking (Example from Normal function Open / Close manually to Lock in 10% opening):

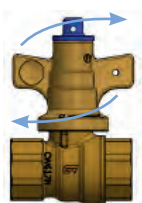

1
Interrumpir el flujo del agua girando el accionamiento en sentido horario. / Stop the water flow rotating the handle in clockwise.



2
Extraer el tapón de protección de plástico. / Remove the plastic protection cap.

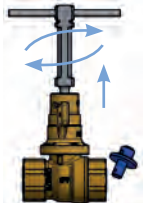

3
Introducir la llave especial hasta enganchar el tornillo y girar en sentido horario hasta que el accionamiento salga del tope del cuerpo hacia arriba. / Insert the special key to engage the screw and rotate clockwise until the handle go out the body's stop upward.

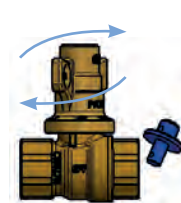

4
Girar el accionamiento hasta la posición de bloqueo deseada (bloqueo 10% apertura). / Rotate the handle until the required locked position (Lock in 10% opening).

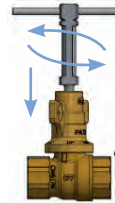

5
Introducir de nuevo la llave especial hasta enganchar el tornillo y girar en sentido anti-horario. El accionamiento quedará bloqueado y no se podrá girar. / Fit the special key again, engage the screw and rotate counter-clockwise. The handle will remain locked and you can not rotate it.

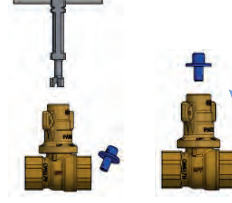

6
Extraer la llave y introducir el tapón de protección. La válvula permanecerá bloqueada (en 10% apertura). / Remove the key and insert the plastic protection cap. The valve will remain locked (at 10% opening).



Sistema antifraude Antifraud system

Funcionamiento válvulas waterworks maneta aluminio

Function waterworks valve aluminum handle

Las válvulas waterworks con maneta de aluminio trabajan en 3 posibles posiciones:

The waterworks valve with aluminum handle work in 3 possible positions:

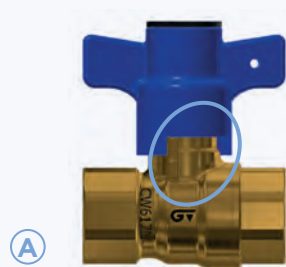

A
Función normal
Abrir / Cerrar manualmente
 Normal function
 Open / Close manually

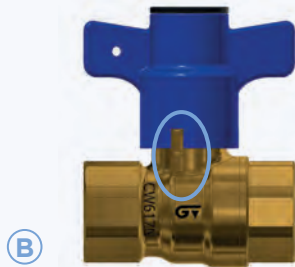

B
Bloqueo en posición Abierta
 Lock in Open position



C
Bloqueo en posición Cerrada
 Lock in Close position

Estas 3 posibles posiciones se consiguen girando el accionamiento a un punto determinado mediante una llave especial. Se debe hacer coincidir la marca del accionamiento con el tope del cuerpo.

These 3 possible positions are achieved by rotating the handle to a determinate point by a special key. It must match the handle's mark with the body's stop.

CÓDIGO CODE	MEDIDA SIZE	PESO WEIGHT	CAJA / BOX CARTON	P.V.P. € PRICE €
-------------	-------------	-------------	-------------------	------------------

Ref. 3430A

NEW

Válvula antifraude recta H-H con maneta de aluminio

PN25. Paso estándar. Construcción en latón UNE-EN 12165. Asientos PTFE. Extremos rosca gas (BSP) H-H - ISO 228/1. Temp. máx. 110°C. Mando manual de aluminio con 3 posiciones mediante llave antifraude, abrir-cerrar, bloqueo abierto y bloqueo cerrado.

Anti-fraud straight valve F-F with aluminum handle

PN 25. Standard bore. Brass construction UNE-EN 12165. PTFE seats. Gas threaded ends (BSP) F-F - ISO 228/1. Max. Temp. 110°C. Aluminum manual control 3 positions with anti-fraud key, open-close, lock opened and lock closed.



R	Ø P	L	A	M
1/2"	13,5	48	49,5	48
3/4"	18	55	52	48

3430A 04	1/2"	0,133	1-1	11,74
3430A 05	3/4"	0,192	1-1	15,63

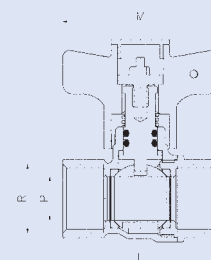

Ref. 3430 - 3430N

Válvula antifraude recta H-H

También disponible con rosca NPT (3430N).
 PN 25. Paso estándar. Construcción en latón UNE-EN 12165. Asientos PTFE. Extremos rosca gas (BSP) H-H - ISO 228/1. Temp. máx. 110°C. Mando manual mediante llave antifraude.

Anti-fraud straight valve F-F

Also available NPT thread (3430N)
 PN 25. Standard bore. Brass construction UNE-EN 12165. PTFE seats. Gas threaded ends (BSP) F-F - ISO 228/1. Max. Temp. 110°C. Manual control with anti-fraud key.



R	Ø P	L	A	M
G 1/2"	13,5	48	63	48,5
G 3/4"	18	55	65,5	48,5
NPT 1/2"	13,5	48	63	48,5
NPT 3/4"	18	55	65,5	48,5

3430 04	1/2"	0,180	5-120	12,76
3430 05	3/4"	0,246	5-90	16,97

3430N 04	1/2"	0,189	5-120	12,76
3430N 05	3/4"	0,275	5-90	16,97

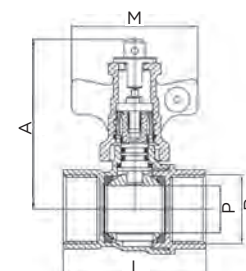

Ref. 3434



Válvula antifraude recta M-H

PN 25. Paso estándar. Construcción en latón UNE-EN 12165. Asientos PTFE. Extremos rosca gas (BSP) M-H - ISO 228/1. Temp. máx. 110°C. Mando manual mediante llave antifraude.

Anti-fraud straight valve M-F

PN 25. Standard bore. Brass construction UNE-EN 12165. PTFE seats. Gas threaded ends (BSP) M-F - ISO 228/1. Max. Temp. 110°C. Manual control with anti-fraud key.

R	Ø P	L	A	M
G 1/2"	13,5	54,5	63	48,5
G 3/4"	18	62,5	65,5	48,5

CÓDIGO CODE	MEDIDA SIZE	PESO WEIGHT	CAJA / BOX CARTON	P.V.P. € PRICE €
----------------	----------------	----------------	----------------------	---------------------

3434 04	1/2"	0,205	5-120	15,13
3434 05	3/4"	0,275	5-90	21,50

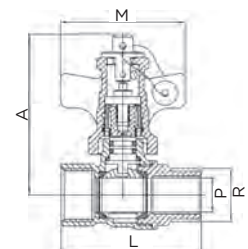

Ref. 3438



Válvula antifraude recta H-tuerca loca

PN 25. Paso estándar. Construcción en latón UNE-EN 12165. Asientos PTFE. Extremos rosca gas (BSP) H-tuerca loca - ISO 228/1. Temp. máx. 110°C. Mando manual mediante llave antifraude.

Anti-fraud straight valve F-free nut

PN 25. Standard bore. Brass construction UNE-EN 12165. PTFE seats. Gas threaded ends (BSP) F-free nut - ISO 228/1. Max. Temp. 110°C. Manual control with anti-fraud key.

r	R	Ø P	L	A	M
G 1/2"	G 3/4"	13,5	59,5	63	48,5
G 3/4"	G 3/4"	18	65	65,5	48,5

3438 04 05	1/2" x 3/4"	0,255	10-120	16,62
3438 05 05	3/4" x 3/4"	0,320	8-96	20,86

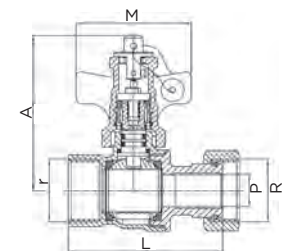

Ref. 3446



Válvula antifraude recta M-tuerca loca

PN 25. Paso estándar. Construcción en latón UNE-EN 12165. Asientos PTFE. Extremos rosca gas (BSP) M-tuerca loca - ISO 228/1. Temp. máx. 110°C. Mando manual mediante llave antifraude.

Anti-fraud straight valve M-free nut

PN 25. Standard bore. Brass construction UNE-EN 12165. PTFE seats. Gas threaded ends (BSP) M-free nut - ISO 228/1. Max. Temp. 110°C. Manual control with anti-fraud key.

r	R	Ø P	L	A	M
G 1/2"	G 3/4"	13,5	62,5	63	48,5
G 3/4"	G 3/4"	18	68,5	65,5	48,5

3446 04 05	1/2" x 3/4"	0,255	10-120	18,24
3446 05 05	3/4" x 3/4"	0,302	8-96	22,58

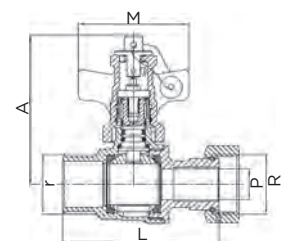

Ref. 3450



Válvula antifraude angular H-H

PN 25. Paso estándar. Construcción en latón UNE-EN 12165. Asientos PTFE. Extremos rosca gas (BSP) H-H - ISO 228/1. Temp. máx. 110°C. Mando manual mediante llave antifraude.

Anti-fraud angle valve F-F

PN 25. Standard bore. Brass construction UNE-EN 12165. PTFE seats. Gas threaded ends (BSP) F-F - ISO 228/1. Max. Temp. 110°C. Command with anti-fraud key.

R	Ø P	L	A	M
G 1/2"	13	24	63	48,5
G 3/4"	17,5	27,5	65,5	48,5

3450 04	1/2"	0,200	10-80	14,54
3450 05	3/4"	0,270	8-64	18,74

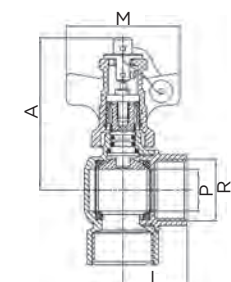

Ref. 3454



Válvula antifraude angular H-tuerca loca

PN 25. Paso estándar. Construcción en latón UNE-EN 12165. Asientos PTFE. Extremos rosca gas (BSP) H-tuerca loca - ISO 228/1. Temp. máx. 110°C. Mando manual mediante llave antifraude.

Anti-fraud angle valve F-free nut

PN 25. Standard bore. Brass construction UNE-EN 12165. PTFE seats. Gas threaded ends (BSP) F-free nut - ISO 228/1. Max. Temp. 110°C. Manual control with anti-fraud key.

r	R	Ø P	L	A	M
G 1/2"	G 3/4"	13	35,5	63	48,5
G 3/4"	G 3/4"	17,5	37,5	65,5	48,5

CÓDIGO CODE	MEDIDA SIZE	PESO WEIGHT	CAJA / BOX CARTON	P.V.P. € PRICE €
-------------	-------------	-------------	-------------------	------------------

3454 04 05	1/2" x 3/4"	0,260	8-96	15,88
3454 05 05	3/4" x 3/4"	0,330	8-96	20,16

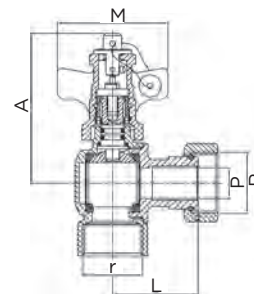

Ref. 3462



Válvula antifraude angular M-tuerca loca

PN 25. Paso estándar. Construcción en latón UNE-EN 12165. Asientos PTFE. Extremos rosca gas (BSP) M-tuerca loca - ISO 228/1. Temp. máx. 110°C. Mando manual mediante llave antifraude.

Anti-fraud angle valve M-free nut

PN 25. Standard bore. Brass construction UNE-EN 12165. PTFE seats. Gas threaded ends (BSP) M-free nut - ISO 228/1. Max. Temp. 110°C. Command with anti-fraud key.

r	R	Ø P	L	A	M
G 1/2"	G 3/4"	13	35,5	63	48,5
G 3/4"	G 3/4"	17,5	37,5	65,5	48,5

3462 04 05	1/2" x 3/4"	0,260	8-96	16,33
3462 05 05	3/4" x 3/4"	0,330	8-96	21,95

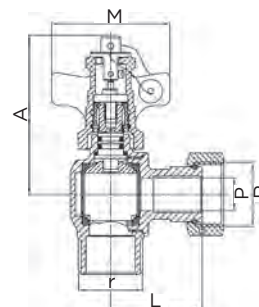

Ref. 3499



Llave accionamiento antifraude

Llave accionamiento antifraude

Anti-fraud manual control key

Anti-fraud manual control key

Ref.	A	B
3499 00	67	65

3499 00	-	0,030	10-240	12,43
---------	---	-------	--------	-------

Precios a consultar / Prices on request

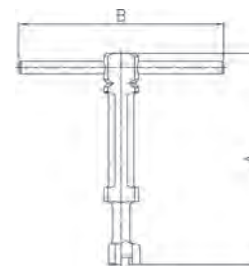



GENEBRE



CLIMATIZACIÓN

CLIMATE CONTROL



Válvulas de calefacción, de seguridad, motorizadas, colectores, termostatos, válvulas para energía solar y bombas de condensación.

Heating valves, safety valves, motorized zone valves, manifolds, thermostats, solar energy valves and condensate pumps.

SISTEMAS DE CLIMATIZACIÓN CLIMATE SYSTEMS

Suelo radiante Underfloor heating



Fan Coil

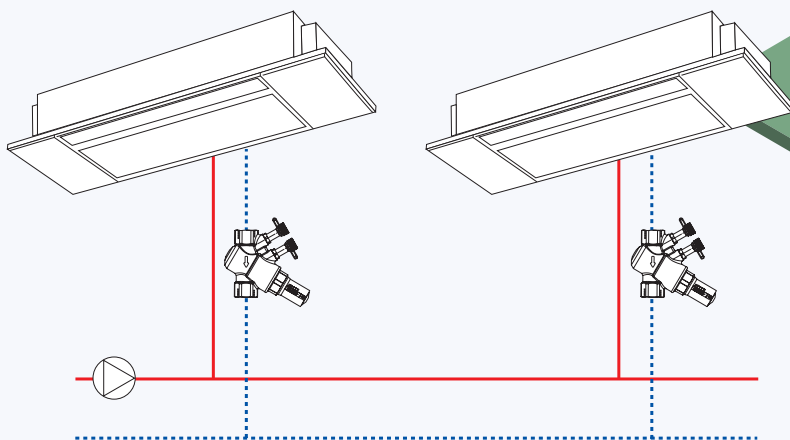

Símbolo identificativo de nuestras válvulas Genebre

Identification symbol
of our Genebre valves





GE-Smart Wifi

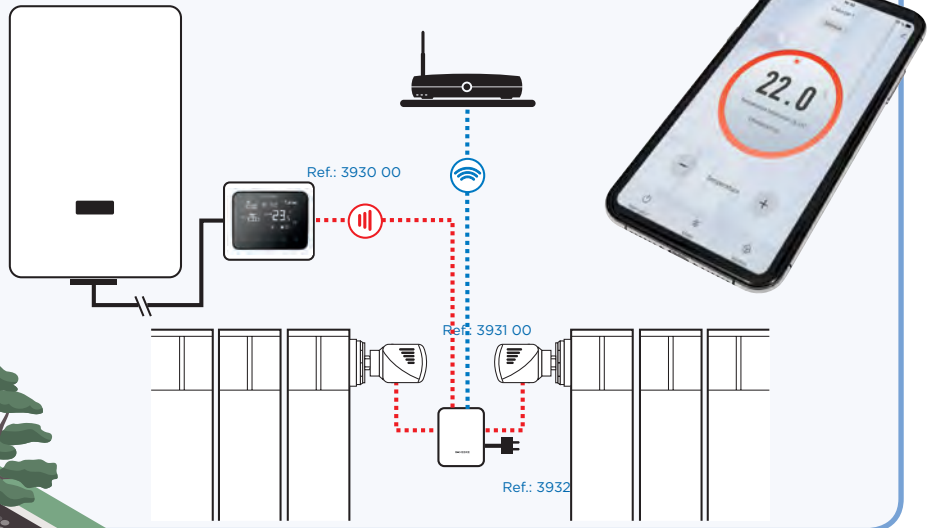

Válvulas de calefacción Heating valves

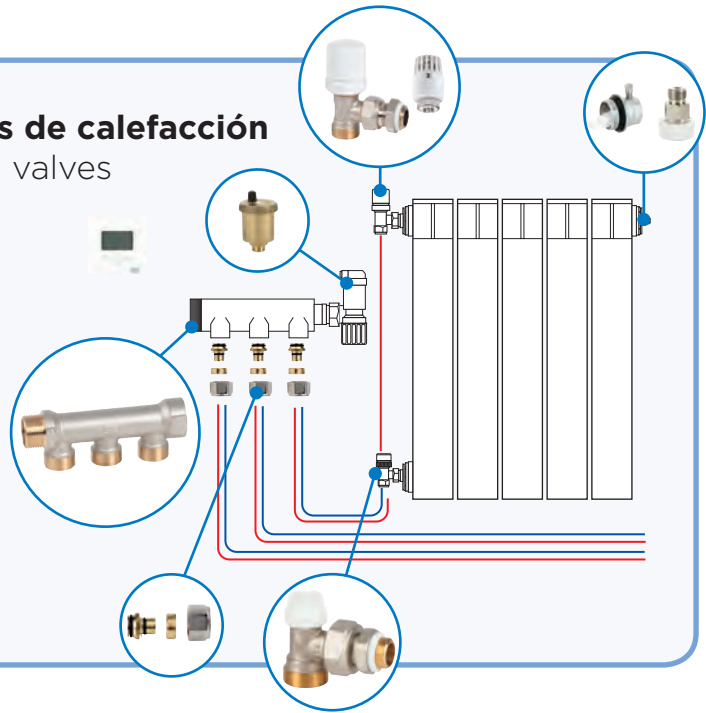

¿Qué es GE-System? What is GE-System?

- **Fácil de instalar** Easy to install
- **Sin necesidad de teflón** No need for Teflon
- **Permite el reapriete** Allows re-tightening

Nuestro innovador sistema GE-System incorpora un anillo PTFE (teflón), que facilita el apriete para una rápida y segura instalación, evitando fugas.

Our innovative GE-System incorporates a PTFE (Teflon) ring, which facilitates tightening for a quick and safe installation, avoiding leaks.

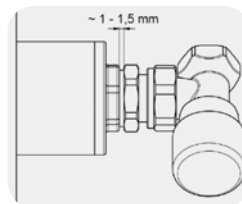

Se considera un apriete correcto cuando la separación entre la contratuercas y el tapón del radiador es aproximadamente 1 mm.

Correct tightening is considered when the clearance between the locknut and the radiator cap is approximately 1mm.

Válvulas para tubo de hierro / Valves for steel pipe

CÓDIGO CODE	MEDIDA SIZE	PESO WEIGHT	CAJA / BOX CARTON	P.V.P. € PRICE €
----------------	----------------	----------------	----------------------	---------------------

Ref. 70151

Válvula manual escuadra para tubo de hierro
Manual angle radiator valve for steel pipe

Medida/Size	H	L
3/8"	69	50
1/2"	69	51



70151 03 40	3/8"	0,158	10-140	6,35
70151 04 40	1/2"	0,159	10-140	6,64

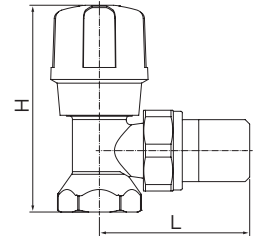

Ref. 70152

Válvula manual recta para tubo de hierro
Manual straight radiator valve for steel pipe

Medida/Size	L	H
3/8"	73	56
1/2"	76	56



70152 03 40	3/8"	0,167	10-140	7,76
70152 04 40	1/2"	0,180	10-140	8,24

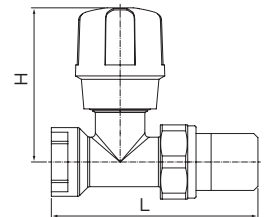

Ref. 70153

Detentor escuadra para tubo de hierro
Angle adjusting lock shield valve for steel pipe

Medida/Size	H	L
3/8"	50	48
1/2"	50	51



70153 03 40	3/8"	0,133	10-140	5,34
70153 04 40	1/2"	0,130	10-140	5,52

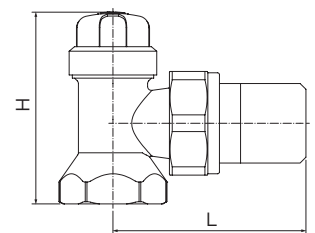

Ref. 70154

Detentor recto para tubo de hierro
Straight adjusting lock shield valve for steel pipe

Medida/Size	L	H
3/8"	73	29
1/2"	76	29



70154 03 40	3/8"	-	10-140	7,39
70154 04 40	1/2"	0,164	10-140	7,73

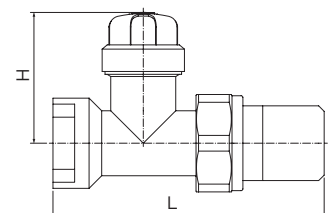

Válvulas para tubo de hierro con GE System / Valves for steel pipe with GE System

CÓDIGO CODE	MEDIDA SIZE	PESO WEIGHT	CAJA / BOX CARTON	P.V.P. € PRICE €
----------------	----------------	----------------	----------------------	---------------------

Ref. 70151

Válvula manual escuadra para tubo de hierro con GE System
Manual angle radiator valve for steel pipe with GE System

Medida/Size	H	L
3/8"	69	50
1/2"	69	51



70151 03 00	3/8"	0,170	10-140	6,62
70151 04 00	1/2"	0,176	10-140	7,17

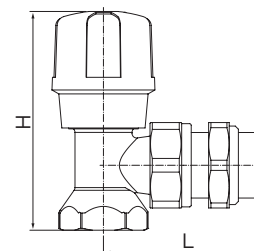

Ref. 70152

Válvula manual recta para tubo de hierro con GE System
Manual straight radiator valve for steel pipe with GE System

Medida/Size	L	H
3/8"	73	56
1/2"	76	56



70152 03 00	3/8"	-	10-1	8,07
70152 04 00	1/2"	0,214	10-140	8,74

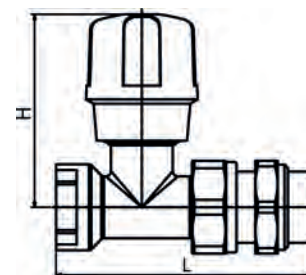

Ref. 70153

Detentor escuadra para tubo de hierro con GE System
Angle adjusting lock shield valve for steel pipe with GE System

Medida/Size	H	L
3/8"	50	48
1/2"	50	51



70153 03 00	3/8"	0,139	10-140	6,01
70153 04 00	1/2"	0,146	10-140	6,09

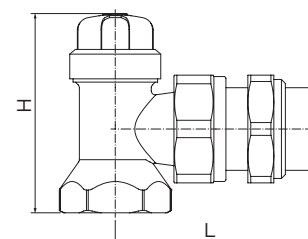

Ref. 70154

Detentor recto para tubo de hierro con GE System
Straight adjusting lock shield valve for steel pipe with GE System

Medida/Size	L	H
3/8"	73	29
1/2"	76	29



70154 03 00	3/8"	0,152	10-1	7,86
70154 04 00	1/2"	0,161	10-140	8,36

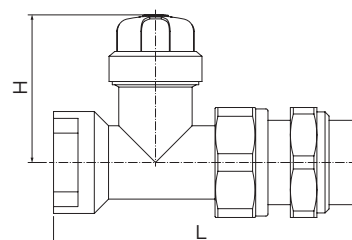

Válvulas termostaticas para tubo de hierro con GE System /
Thermostatic valves for steel pipe with GE System

CÓDIGO CODE	MEDIDA SIZE	PESO WEIGHT	CAJA / BOX CARTON	P.V.P. € PRICE €
----------------	----------------	----------------	----------------------	---------------------

Ref. 70031

Válvula termostaticable escuadra para tubo de hierro con GE System

Angle radiator valve with thermostatic option, for steel pipe with GE System

Medida/Size	H	L
3/8"	84	49
1/2"	84	52



70031 03 00	3/8"	0,200	10-100	8,69
70031 04 00	1/2"	0,250	10-80	9,15

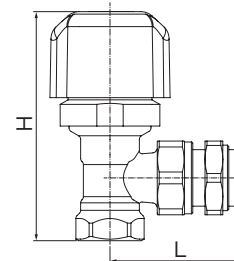

Ref. 70032

Válvula termostaticable recta para tubo de hierro con GE System

Straight radiator valve with thermostatic option, for steel pipe with GE System

Medida/Size	L	H
3/8"	49	84
1/2"	52	84



70032 03 00	3/8"	0,250	10-80	11,37
70032 04 00	1/2"	0,250	10-100	11,83

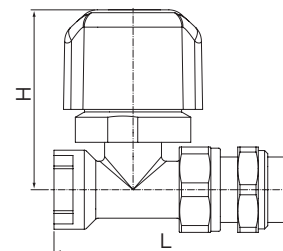

Ref. 70153

Detentor escuadra para tubo de hierro con GE System

Angle adjusting lock shield valve for steel pipe with GE System

Medida/Size	H	L
3/8"	50	48
1/2"	50	51



70153 03 00	3/8"	0,139	10-140	6,01
70153 04 00	1/2"	0,146	10-140	6,09

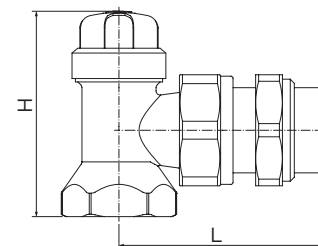

Ref. 70154

Detentor recto para tubo de hierro con GE System

Straight adjusting lock shield valve for steel pipe with GE System

Medida/Size	L	H
3/8"	73	29
1/2"	76	29



70154 03 00	3/8"	0,152	10-1	7,86
70154 04 00	1/2"	0,161	10-140	8,36

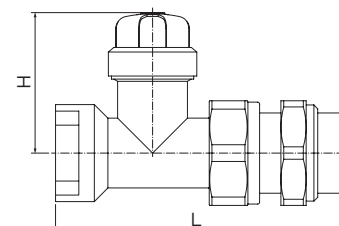

Válvulas para tubo de cobre, PEX o multicapa / Valves for copper, polyethylene or multilayer pipe

CÓDIGO CODE	MEDIDA SIZE	PESO WEIGHT	CAJA / BOX CARTON	P.V.P. € PRICE €
----------------	----------------	----------------	----------------------	---------------------

Ref. 70587

Válvula manual escuadra para tubo de cobre, PEX o multicapa

Manual angle radiator valve for cooper, polyethylene or multilayer pipe

Medida/Size	H	L
3/8"	70	49
1/2"	70	52



70587 03 40	3/8"	0,154	10-140	5,75
70587 04 40	1/2"	0,166	10-140	6,05

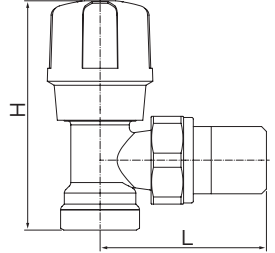

Ref. 70588

Válvula manual recta para tubo de cobre, PEX o multicapa

Manual straight radiator valve for cooper, polyethylene or multilayer pipe

Medida/Size	L	H
3/8"	74	56
1/2"	77	56



70588 03 40	3/8"	0,200	10-1	9,01
70588 04 40	1/2"	0,400	10-1	9,09

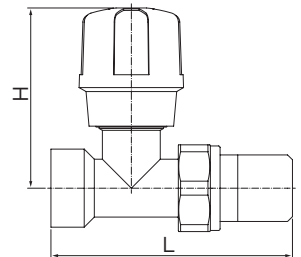

Ref. 70564

Detentor escuadra para tubo cobre, PEX o multicapa

Angle lock shield valve for copper, PEX or multilayer pipe

Medida/Size	L	H
3/8"	50	50
1/2"	52	50



70564 03 40	3/8"	0,150	10-140	5,09
70564 04 40	1/2"	0,143	10-140	5,34

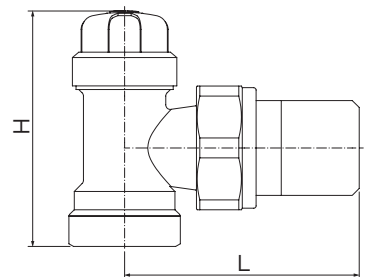

Ref. 70565

Detentor recto para tubo cobre, PEX o multicapa

Straight lock shield valve for copper, PEX or multilayer pipe

Medida/Size	L	H
3/8"	74	29
1/2"	74	29



70565 03 40	3/8"	0,200	1-1	7,67
70565 04 40	1/2"	0,500	10-100	7,99

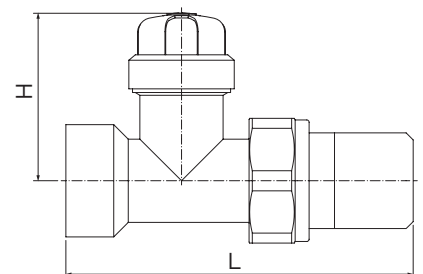

Válvulas para tubo de cobre, PEX o multicapa con GE System /
Valves for copper, polyethylene or multilayer pipe with GE System

CÓDIGO CODE	MEDIDA SIZE	PESO WEIGHT	CAJA / BOX CARTON	P.V.P. € PRICE €
----------------	----------------	----------------	----------------------	---------------------

Ref. 70587

Válvula manual escuadra para tubo de cobre, PEX o multicapa con GE System

Manual angle radiator valve for cooper, polyethylene or multilayer pipe with GE System

Medida/Size	H	L
3/8"	70	49
1/2"	70	52



70587 03 00	3/8"	0,166	10-140	6,33
70587 04 00	1/2"	0,183	10-140	6,86

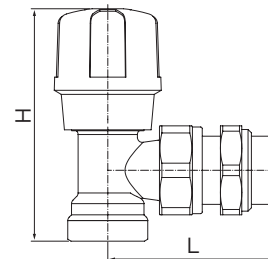

Ref. 70588

Válvula manual recta para tubo de cobre, PEX o multicapa con GE System

Manual straight radiator valve for cooper, polyethylene or multilayer pipe with GE System

Medida/Size	L	H
3/8"	74	56
1/2"	77	56



70588 03 00	3/8"	0,200	10-1	9,95
70588 04 00	1/2"	0,200	1-1	10,42

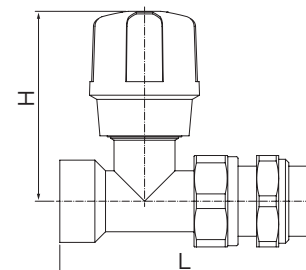

Ref. 70564

Detentor escuadra para tubo cobre, PEX o multicapa con GE System

Angle lock shield valve for copper, PEX or multilayer pipe with GE System

Medida/Size	L	H
3/8"	50	50
1/2"	52	50



70564 03 00	3/8"	0,137	10-140	5,63
70564 04 00	1/2"	0,153	10-140	6,10

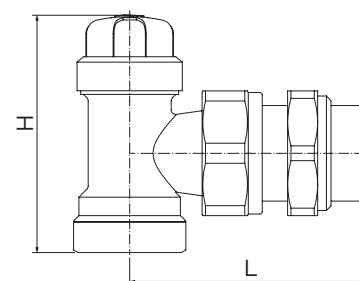

Ref. 70565

Detentor recto para tubo cobre, PEX o multicapa con GE System

Straight lock shield valve for copper, PEX or multilayer pipe with GE System

Medida/Size	L	H
3/8"	74	29
1/2"	74	29



70565 03 00	3/8"	0,170	10-1	8,77
70565 04 00	1/2"	0,180	10-1	8,97

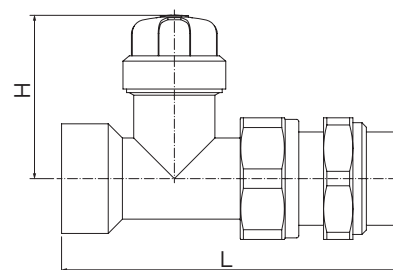

Válvulas termostaticas para tubo de cobre, PEX o multicapa con GE System / Thermostatic valves for copper, polyethylene or multilayer pipe with GE System

Ref. 70048



Válvula termostaticable escuadra para tubo cobre, polietileno o multicapa con GE System

Angle radiator valve with thermostatic option, for copper or polyethylene pipe with GE System

Medida/Size	H	L
3/8"	84	49
1/2"	84	52

CÓDIGO CODE	MEDIDA SIZE	PESO WEIGHT	CAJA / BOX CARTON	P.V.P. € PRICE €
-------------	-------------	-------------	-------------------	------------------

70048 03 00	3/8"	0,212	10-80	8,69
70048 04 00	1/2"	0,229	10-80	9,15

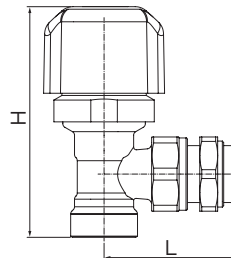

Ref. 70049



Válvula termostaticable recta para tubo cobre, polietileno o multicapa con GE Sytem

Straight radiator valve with thermostatic option, for copper or polyethylene pipe with GE System

Medida/Size	L	H
3/8"	49	84
1/2"	52	84

70049 03 00	3/8"	0,010	10-80	13,27
70049 04 00	1/2"	0,260	10-80	13,51

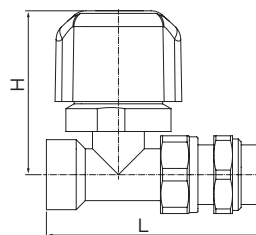

Ref. 70564



Detentor escuadra para tubo cobre, PEX o multicapa con GE System

Angle lock shield valve for copper, PEX or multilayer pipe with GE System

Medida/Size	L	H
3/8"	50	50
1/2"	52	50

70564 03 00	3/8"	0,137	10-140	5,63
70564 04 00	1/2"	0,153	10-140	6,10

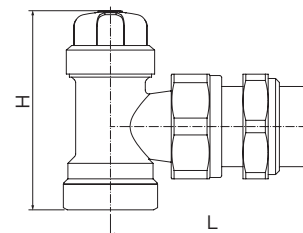

Ref. 70565



Detentor recto para tubo cobre, PEX o multicapa con GE System

Straight lock shield valve for copper, PEX or multilayer pipe with GE System

Medida/Size	L	H
3/8"	74	29
1/2"	74	29

70565 03 00	3/8"	0,170	10-1	8,77
70565 04 00	1/2"	0,180	10-1	8,97

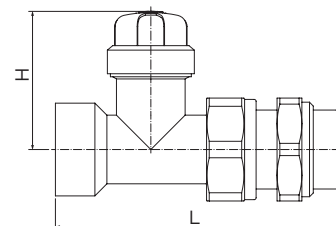

CÓDIGO CODE	MEDIDA SIZE	PESO WEIGHT	CAJA / BOX CARTON	P.V.P. € PRICE €
----------------	----------------	----------------	----------------------	---------------------

Ref. 79001

NEW

Kit-Ge Termostatizable GE-SYSTEM

Ref. 79001 04 15: KIT Termostatizable **para Tubo de Cobre** con Rosca Genebre. Se compone de:
 - Válvula termostatizable 70048 04 00.
 - Detentor 70564 04 00.
 - Y dos racor para tubo de cobre 70041 15 20.
 - Construcción en latón. Temperatura máxima de trabajo 95°C. Presión máxima de trabajo 10 bar.

79001 04 15	1/2"	0,460	5-25	18,79
79001 04 16	1/2"	0,520	5-25	19,07



Ref. 79001 04 16: KIT Termostatizable **para Tubo Multicapa** con Rosca Genebre. Se compone de:
 - Válvula termostatizable 70048 04 00.
 - Detentor 70564 04 00.
 - Y dos racor para tubo multicapa 70070 16 00.
 - Construcción en latón. Temperatura máxima de trabajo 95°C. Presión máxima de trabajo 10 bar.

Thermostatic kit GE-SYSTEM

79001 04 15. Thermostatic kit GE-SYSTEM for copper pipe with GENEBRE threaded. The kit consists of:
 - 70048 04 00 thermostatic angle valve.
 - 70564 04 00 angle lack shield valve.
 - And two 70041 15 20 copper pipe fittings.
 - Brass construction. Maximum working temperature 95°C. Maximum working pressure 10 bar.

79001 04 16. Thermostatic kit GE-SYSTEM for multilayer pipe with GENEBRE threaded. The kit consists of:
 - 70048 04 00 thermostatic angle valve.
 - 70564 04 00 angle lack shield valve.
 - And two 70070 16 00 multilayer pipe fittings.
 - Brass construction. Maximum working temperature 95°C. Maximum working pressure 10 bar.

Ref. 79002

NEW

Kit-Ge Manual GE-SYSTEM

Ref. 79002 04 15: Kit manual GE-SYSTEM **para tubo de cobre** con rosca Genebre. Se compone de:
 - Válvula manual 70587 04 00.
 - Detentor 70564 04 00.
 - Y dos racor para tubo de cobre 70041 15 20.
 - Construcción en latón. Temperatura máxima de trabajo 95°C. Presión máxima de trabajo 10 bar.

79002 04 15	1/2"	0,412	5-25	16,31
79002 04 16	1/2"	0,480	5-25	16,59



Ref. 79002 04 16: Kit manual GE-SYSTEM **para tubo multicapa** con rosca Genebre. Se compone de:
 - Válvula manual 70587 04 00.
 - Detentor 70564 04 00.
 - Y dos racor para tubo multicapa 70070 16 00.
 - Construcción en latón. Temperatura máxima de trabajo 95°C. Presión máxima de trabajo 10 bar.

Manual kit GE-SYSTEM

79002 04 15. Manual kit GE-SYSTEM for copper pipe with GENEBRE threaded. The kit consists of:
 - 70587 04 00 manual angle valve.
 - 70564 04 00 angle lack shield valve.
 - And two 70041 15 20 copper pipe fittings.
 - Brass construction. Maximum working temperature 95°C. Maximum working pressure 10 bar.

79002 04 16. Manual kit for multilayer pipe with GENEBRE threaded. The kit consists of:
 - 70587 04 00 manual angle valve.
 - 70564 04 00 angle lack shield valve.
 - And two 70070 16 00 multilayer pipe fittings.
 - Brass construction. Maximum working temperature 95°C. Maximum working pressure 10 bar.

Ref. 70590

Cabezal termostático

Uso para válvulas termostatizables. Construcción en ABS ignífugo. Rango de temperaturas de 6°C a 28°C con dispositivo antihielo. Sensor líquido de expansión por calor. Conexión rosca M30 x 1,5. Presión máx. de trabajo 10 bar. Temp. máx. de trabajo 50°C. Dimensiones 81 x Ø 48.

70590 00 00	M30 x 1,5	0,121	1-144	15,57
-------------	-----------	-------	-------	--------------



Thermostatic head

For thermostatic valves use. ABS fireproof construction. Temperature range from 6°C to 28°C with defrosting device. Liquid sensor heat expansion. Thread connection M30 x 1,5. Max. working pressure 10 bar. Max. working temp. 50°C. Dimensions 81 x Ø 48.

CÓDIGO CODE	MEDIDA SIZE	PESO WEIGHT	CAJA / BOX CARTON	P.V.P. € PRICE €
----------------	----------------	----------------	----------------------	---------------------

Ref. 3931

NEW

Cabezal termostático "GE-SMART"

Alimentación: 2 baterías 1,5V, tipo AA. Conectividad WIFI. IP20. Rango temperatura de regulación: 5-35°C. Diferencial termico ± 0,5 °C . Pantalla LCD retro iluminada. Programable. Dimensiones: Ø55 x 83 mm.

"GE-SMART" thermostatic head

Power supply 2 batteries 1,5V. AA. WIFI connectivity. IP20. Setting temperature range: 5-35°C. Differential: ± 0,5 °C . LCD backlight display. Programmable. Dimensions: Ø55 x 83 mm.



3931 00	-	0,140	1-42	65,52
---------	---	-------	------	-------

Ref. 72501

Cabezal termostático programable para radiadores

Uso para válvulas termostaticables. Alimentación con dos baterías 1,5V tipo AA. Funcionamiento automático con dos niveles de temperatura (comfort o económico) o manual mediante la rueda de selección. Temperatura de funcionamiento de 0°C a 55°C. Temperatura de protección antihielo 6°C. Grado de protección IP30. Dimensiones 52x83x56cm

Programmable thermostatic head for radiators

For thermostatic valves use. Power supply two batteries 1,5V AA. Automatic operation with two levels of temperature (comfort or economic) or manual through the selection wheel. Working temperature from 0°C to 55°C. Antifreeze against 6°C. IP30. Dimensions 52x83x56cm



72501 00 00	-	0,158	1	54,84
-------------	---	-------	---	-------

Ref. 70306

NEW

Actuador electrotérmico

Alimentación: 24V / 220-240V (±10%) 50-60 Hz. P=1,2W. Construcción en polímero ignífugo, cable de 2 hilos, funda de PVC. Posición de la válvula n/c. Clase de protección IP54. Temperatura ambiente máx. de trabajo 60°C. Temperatura máx. del fluido 100°C. Presión máx. de trabajo 10 bar.

Electrothermal actuator

Power supply: 24V / 220-240V (±10%) 50-60 Hz. P=1,2W. Fireproof polymer construction. Two wire cable with PVC cover. Normally closed valve position. Protection class IP54. Max. working ambient temperature 60°C. Max. fluid temperature 100°C. Max. working pressure 10 bar.



Ref.	Alimentación/ Power supply
70306 00 02	220/230 V
70306 00 12	24 V

70306 00 02	M30 x 1,5	0,100	1-100	25,82
-------------	-----------	-------	-------	-------

70306 00 12	M30 x 1,5	0,115	1-100	25,82
-------------	-----------	-------	-------	-------

Ref. 73189

NEW

Actuador electrotérmico con microrruptor auxiliar

Alimentación: 220-240V (±10%) 50-60 Hz. P=1,2W. Construcción en polímero ignífugo, cable de 4 hilos, funda de PVC. Posición de la válvula n/c. Clase de protección IP54. Temperatura ambiente máx. de trabajo 60°C. Presión máx. de trabajo 10 bar.

Electrothermal actuator with auxiliary microswitch

Power supply: 220-240V (±10%) 50-60 Hz. P=1,2W. Fireproof polymer construction. 4 wire cable with PVC cover. Normally closed valve position. Protection class IP54. Max. environment working temperature 60°C. Max. working pressure 10 bar.



73189 00 42	M30 x 1,5	-	1-1	45,60
-------------	-----------	---	-----	-------

Ref. 70585

Válvula monotubo simple

Construcción en latón UNE-EN 12164-12165. Juntas de cierre en elastómetro. Volante en ABS. Conexión al emisor rosca macho ISO 228/1. Conexión a tubería de cobre y plástico mediante racor. Rosca macho W24,5 x 19h/1". Temp. máx. de trabajo 100°C. Presión máx. de trabajo 10 bar.

Valve for single-pipe installation

Brass construction UNE-EN 12164-12165. Elastomer sealing joints. ABS steering wheel. Terminal connection male thread ISO 228/1. Cooper and plastic connection by means a fitting. Male thread W24,5 x 19h/1". Max. working temp. 100°C. Max. working pressure 10 bar.



Medida/Size	L	H	M	E	R
1/2"	236	130	117	37	1/2"

70585 04 00	1/2"	0,200	3-27	24,87
-------------	------	-------	------	-------

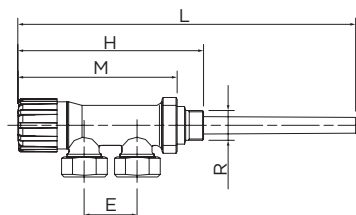

Ref. 71028



Válvula monotubo termostatizable

Construcción en latón UNE-EN 12164-12165. Juntas de cierre en elastómero. Volante en ABS. Conexión al emisor rosca macho ISO 228/1. Conexión a tubería de cobre y plástico mediante racor. Rosca macho W24,5 x 19h/1". Mando manual intercambiable. Sonda de entrada incorporada. Temp. máx. de trabajo 110°C. Presión máx. de trabajo 10 bar.

Thermostatic valve for single-pipe installation

Brass construction UNE-EN 12164-12165. Elastomer sealing joints. ABS steering wheel. Terminal connection male thread ISO 228/1. Cooper and plastic connection by means a fitting. Male thread W24,5 x 19h/1". Easy replaceable manual control. Inlet probe incorporated. Max. working temp. 110°C. Max. working pressure 10 bar.

Medida/Size	L	H	E	D	R	Ø d
1/2"	148	49	37	260	1/2"	10

CÓDIGO CODE	MEDIDA SIZE	PESO WEIGHT	CAJA / BOX CARTON	P.V.P. € PRICE €
-------------	-------------	-------------	-------------------	------------------

71028 04 00	1/2"	0,400	4-24	25,94
-------------	------	-------	------	-------

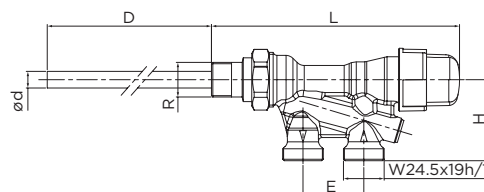

Ref. 75404



Válvula monotubo termostatizable 4 vias para radiador

Construcción en latón UNE-EN 12164-12165. Juntas de cierre en elastómero. Volante en ABS. Conexión al emisor rosca macho ISO 228/1. Conexión a tubería de cobre y plástico mediante racor. Rosca macho W24,5 x 19h/1". Mando manual intercambiable. Sonda de entrada incorporada. Temp. máx. de trabajo 110°C. Presión máx. de trabajo 10 bar.

4 ways valve with thermostatic option for radiators

Brass construction UNE-EN 12164-12165. Elastomer sealing joints. ABS steering wheel. Terminal connection male thread ISO 228/1. Cooper and plastic connection by means a fitting. Male thread W24,5 x 19h/1". Easy replaceable manual control. Inlet probe incorporated. Max. working temp. 110°C. Max. working pressure 10 bar.

Medida/Size	R	R1	L	H	A	B	D
1/2"	1/2"	W24,5x19h/1"	353	36	47,5	85	37

75404 04 00	1/2"	0,466	4-1	38,43
-------------	------	-------	-----	-------

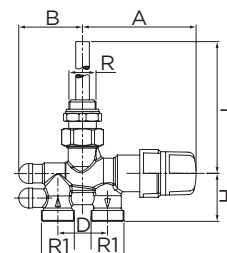

Ref. 70177



Codo para conexión valvula monotubo

Construcción en latón niquelado UNE-EN 12165. Junta de EPDM peróxido. Rosca Macho - Hembra W24,5 x 19h/1". Temp. máx. de trabajo 110°C. Presión máx. de trabajo 10 bar.

Elbow fitting for valve-pipe connection

Nickel-plated brass construction UNE-EN 12165. EPDM PEROX seal. Male - Female thread W24,5 x 19h/1". Max. working temp. 110°C. Max. working pressure 10 bar.

R1	R	A	B
W24,5 x 19h/1"	W24,5 x 19/h1"	47,5	26

70177 00 10	W24,5 x 19h"	-	20-1	15,67
-------------	--------------	---	------	-------

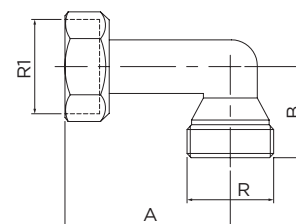

Rosca GENE BRE W24,5 x 19h"
GENEBRE threaded W24,5 x 19h"



Rosca Gas G1/2" ISO 228/1
Gas threaded G1/2" ISO 228/1



Rosca Eurokonus G3/4" ISO 228/1
Eurokonus threaded G3/4" ISO 228/1

CÓDIGO CODE	MEDIDA SIZE	PESO WEIGHT	CAJA / BOX CARTON	P.V.P. € PRICE €
----------------	----------------	----------------	----------------------	---------------------

Ref. 70041



Racor tubo cobre

Tuerca y casquillo en latón. Tuerca niquelada. Junta de cierre en NBR. Rosca hembra W24,5 x 19h/1". Temp. máx. de trabajo 95°C. Presión máx. de trabajo 10 bar.

Copper pipe fitting

Nut and ring in brass. Nickel-plated nut. NBR sealing joint. Female thread W24,5 x 19h/1". Max. working temp. 95°C. Max. working pressure 10 bar.

70041 12 20	Ø 12	0,042	10-300	2,89
70041 15 20	Ø 15	0,038	10-300	2,89



Ref. 70071



Racor tubo polietileno reticulado (PEX)

Construcción en latón. Tuerca niquelada. Junta de cierre en NBR. Rosca hembra W24,5 x 19h/1". Temperatura máxima de trabajo 95°C. Presión máxima de trabajo 10 bar.

PEX polyethylene pipe fitting

Brass construction. Nickel-plated nut. NBR sealing joint. Female thread w24,5 x 19h/1". Maximum working temperature 95°C. Maximum working pressure 10 bar.

70071 16 00	Ø 16 x 2	0,060	10-100	3,11
70071 16 20	Ø 16 x 1,5	0,060	10-300	2,89



Ref. 70070



Racor tubo multicapa

Construcción en latón. Tuerca niquelada. Juntas de cierre en NBR. Rosca hembra W24,5 x 19h/1". Temp. máx. de trabajo 95°C. Presión máx. de trabajo 10 bar.

Multilayer pipe fitting

Brass construction. Nickel-plated nut. NBR sealing joints. Female thread W24,5 x 19h/1". Max. working temp. 95°C. Max. working pressure 10 bar.

70070 16 00	Ø 16 x 2	0,067	10-300	3,15
70070 18 00	Ø 18 x 2	0,066	10-300	3,11

70070 20 00	Ø 20 x 2	0,067	10-300	3,22
70070 20 20	Ø 20 x 2,25	0,064	10-300	2,86



Ref. 70139

NEW

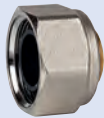

Racor tubo cobre rosca G1/2''

Construcción en latón. Tuerca niquelada. Junta de cierre de NBR. Rosca hembra gas (BSP) G1/2'' según ISO 228/1. Temperatura máxima de trabajo 95°C. Presión máxima de trabajo 10 bar.

Copper pipe fitting G1/2'' threaded

Brass construction. Nickel plated nut. NBR sealing joint. Female gas (BSP) thread G1/2''. Maximum working temperature 95°C. Maximum working pressure 10 bar.

70139 12 50	Ø12	0,021	10-1000	4,72
-------------	-----	-------	---------	------



Ref. 70735

NEW

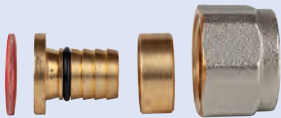

Racor tubo PE + Multicapa rosca G1/2'' BSP

Construcción en latón. Tuerca niquelada. Junta de cierre de fibra. Rosca hembra gas (BSP) G1/2'' según ISO 228/1. Temperatura máxima de trabajo 95°C. Presión máxima de trabajo 10 bar. Racor para el colector ref. 70024.

Multilayer + PE pipe fitting G1/2'' threaded BSP

Brass construction. Nickel plated nut. Fiber sealing joint. Female gas (BSP) thread G1/2''. Maximum working temperature 95°C. Maximum working pressure 10 bar. Fitting for the manifold ref. 70024.

70735 16 10	Ø16 x 2	0,037	400	3,12
-------------	---------	-------	-----	------



Ref. 70224

NEW



Racor tubo multicapa Euroconus rosca G3/4''

Construcción en latón. Tuerca niquelada. Cierre de elastomero. Rosca hembra gas (BSP) G3/4'' según ISO 228/1. Temperatura máxima de trabajo 95°C. Presión máxima de trabajo 10 bar.

Euroconus multilayer pipe fitting G3/4'' threaded

Brass construction. Nickel plated nut. Elastomer sealing. Female gas (BSP) thread G3/4''. Maximum working temperature 95°C. Maximum working pressure 10 bar.

70224 16 00	Ø16 x 2	0,078	10-300	4,40
-------------	---------	-------	--------	------



Ref. 70042



Tapón para colectores

Construcción en latón niquelado UNE-EN 12165. Junta de PTFE. Rosca hembra W24,5 x 19h/1". Temp. máx. de trabajo 110°C. Presión máx. de trabajo 10 bar.

Blind cap for manifold

Nickel-plated brass construction UNE-EN 12165. PTFE seal. Female thread W24,5 x 19h/1". Max. working temp. 110°C. Max. working pressure 10 bar.

70042 00 00	W24,5 x 19h"	0,032	20-500	4,72
-------------	--------------	-------	--------	------



Ref. 70069

LLave para racor fitting de W24,5 x 19h"

Llave con conexión angular para apretar fácilmente en montaje en cualquier posición. Para racor rosca withworth diámetro 24,5 x 19 hilos por pulgada.

Spanner for W24,5 x 19t" fitting

Angled connection spanner for easily tighten fittings in any position. For withworth thread diameter 24,5 x 19 threads per inch fittings.



CÓDIGO CODE	MEDIDA SIZE	PESO WEIGHT	CAJA / BOX CARTON	P.V.P. € PRICE €
----------------	----------------	----------------	----------------------	---------------------

70069 00 00	Ch 28	0,024	10-1	23,62
-------------	-------	-------	------	-------



Ref. 70024

Colector simple componible 2, 3 y 4 vías

PN 10. Construcción en latón niquelado UNE-EN 12165. Conexión en línea rosca gas (BSP) M - H, ISO 228/1. Conexión derivación macho, G1/2" ISO 228/1. Máxima temperatura de trabajo 180°C.

2, 3 and 4 ways modular single manifold

PN 10. Nickel-plated brass construction UNE-EN 12165. Line connection threaded ends gas (BSP) M - F, ISO 228/1. Lateral connections male, G1/2" ISO 228/1. Maximum working temperature 180°C.

R	Salidas/Ways	DN	L	X
3/4"	2	20	85	36
3/4"	3	20	121	36
3/4"	4	20	157	36
1"	2	25	104	42
1"	3	25	146	42
1"	4	25	188	42

70024 05 02	3/4"	0,153	8-64	6,98
-------------	------	-------	------	------

70024 05 03	3/4"	0,199	5-40	9,14
-------------	------	-------	------	------

70024 05 04	3/4"	0,237	4-32	10,75
-------------	------	-------	------	-------

70024 06 02	1"	0,250	8-64	11,47
-------------	----	-------	------	-------

70024 06 03	1"	0,332	5-40	15,08
-------------	----	-------	------	-------

70024 06 04	1"	0,412	4-32	18,73
-------------	----	-------	------	-------

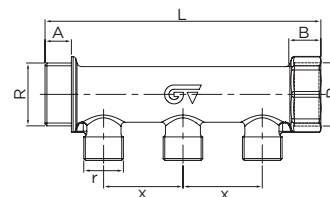

Ref. 70035

Colector simple componible 2, 3 y 4 vías

Construcción en latón niquelado UNE-EN 12165. Conexión en derivación lateral rosca macho W24,5 x 19h/1". Conexión en línea rosca macho, hembra ISO 228/1. Temperatura máxima de trabajo: 180°C. Presión máxima de trabajo: 10 bar.

2, 3 and 4 ways module single manifold

Nickle-plated brass construction UNE-EN 12165. Lateral branch connection male thread W24,5 x 19h/1". Threaded ends connection male-female ISO 228/1. Maximum working temperature: 180°C. Maximum working pressure: 10 bar.

R	N.º Derivaciones/ Branches num.	DN	L	X
3/4"	2	20	87	36
3/4"	3	20	123	36
3/4"	4	20	159	36
1"	2	25	105	42
1"	3	25	147	42
1"	4	25	189	42

70035 05 02	3/4"	0,200	8-64	8,02
-------------	------	-------	------	------

70035 05 03	3/4"	0,264	5-40	10,99
-------------	------	-------	------	-------

70035 05 04	3/4"	0,326	4-32	14,86
-------------	------	-------	------	-------

70035 06 02	1"	0,314	8-64	12,83
-------------	----	-------	------	-------

70035 06 03	1"	0,427	5-40	16,80
-------------	----	-------	------	-------

70035 06 04	1"	0,545	4-32	21,03
-------------	----	-------	------	-------

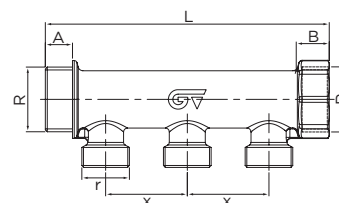

Ref. 70171

Colector simple componible sanitario con regulación 2, 3 y 4 vías

Construcción en latón, acabado niquelado. Juntas de EPDM. Volante de ABS, antirrotor. Conexiones derivadas rosca macho W24,5x19h/1". Conexiones en línea rosca macho-hembra ISO 228/1. Temperatura máxima de trabajo 95°C. Presión máxima de trabajo 10 bar.

2, 3 and 4 ways modular sanitary manifold with adjustment

Brass construction, nickel-plated finishing. EPDM joints. ABS wheel, against steering. Lateral branch connections male thread W24,5x19t/1". threaded ends connection male-female ISO 228/1. Maximum working temperature 95°C. Maximum working pressure 10 bar.

R	N.º Derivaciones/ Branches num.	DN	L	B
3/4"	2	20	94,5	37
3/4"	3	20	131,5	37
3/4"	4	20	168,5	37
1"	2	25	94,5	37
1"	3	25	131,5	37
1"	4	25	168,5	37

70171 05 02	3/4"	0,386	5-20	22,33
-------------	------	-------	------	-------

70171 05 03	3/4"	0,538	1-10	27,42
-------------	------	-------	------	-------

70171 05 04	3/4"	0,701	5-20	35,84
-------------	------	-------	------	-------

70171 06 02	1"	0,475	5-20	21,85
-------------	----	-------	------	-------

70171 06 03	1"	0,688	5-20	30,36
-------------	----	-------	------	-------

70171 06 04	1"	0,917	5-20	41,13
-------------	----	-------	------	-------

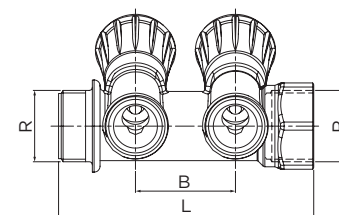

Ref. 70176



Colector de distribución Acero Inoxidable

Fabricado en acero inoxidable AISI 304L. Conexión principal rosca hembra ISO 228/1 de 1". Conexiones derivadas rosca hembra ISO 228/1 de 1/2". Temperatura máxima de trabajo 110°C. Presión máxima de trabajo 10 bar.

Stainless steel Manifold double side

Made in stainless steel AISI 304L. Threaded ends connections female ISO 228/1 of 1". Lateral connections female thread ISO 228/1 of 1/2". Maximum working temperature 110°C. Maximum working pressure 10 bar.

Salidas/Ways	4	5	6	7	8
X	50	50	50	50	50
L	243	293	343	393	443

CÓDIGO CODE	MEDIDA SIZE	PESO WEIGHT	CAJA / BOX CARTON	P.V.P. € PRICE €
----------------	----------------	----------------	----------------------	---------------------

70176 06 04	1"	0,350	1	16,34
70176 06 05	1"	0,400	1	20,27
70176 06 06	1"	0,494	1	22,27
70176 06 07	1"	0,550	1	27,24
70176 06 08	1"	0,650	1	30,39

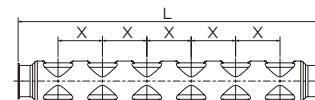

Ref. 3179 - 3189



Válvula de seguridad escuadra-3 bar (3179) Válvula de seguridad escuadra-6 bar (3189)

Cuerpo en latón. Muelle de acero INOX AISI 302. Obturador en EPDM. Membrana en EPDM. Extremos roscados hembra-hembra ISO 228/1. Presión máx. de trabajo 10 bar. Temp. máx. 90°C.

Safety relief angle valve-3 bar (3179) Safety relief angle valve-6 bar (3189)

Brass body. Stainless steel AISI 302 spring. EPDM joint. EPDM membrane. Female-female threaded ends ISO 228/1. Max. working pressure 10 bar. Max. working temp. 90°C.

L	H
42	69

3179 04	1/2"	0,116	10-100	7,25
3189 04	1/2"	0,116	10-100	7,25

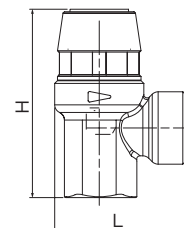

Ref. 3182 - 3188



Válvula de seguridad escuadra-3 bar (3182) Válvula de seguridad escuadra-6 bar (3188)

Cuerpo en latón. Muelle de acero inox AISI 302. Obturador en EPDM. Membrana en EPDM. Extremos roscados macho-hembra ISO 228/1. Presión máx. de trabajo 10 bar. Temperatura máx. 90°C.

Safety relief angle valve-3 bar (3182) Safety relief angle valve-6 bar (3188)

Brass body. Stainless steel AISI 302 spring. EPDM joint. EPDM membrane. Female-female threaded ends ISO 228/1. Max. working pressure 10 bar. Max. working temp. 90°C.

L	H
42	72

3182 04	1/2"	0,118	10-100	7,25
3188 04	1/2"	0,100	10-100	7,25

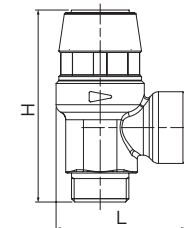

Ref. 3191 - 3192



Válvula de seguridad escuadra con conexión manómetro-3 bar (3191) Válvula de seguridad escuadra con conexión manómetro-6 bar (3192)

Cuerpo en latón. Muelle de acero INOX AISI 302. Obturador en EPDM. Membrana en EPDM. Extremos roscados macho-hembra ISO 228/1. Presión máx. de trabajo 10 bar. Temp. máx. 90°C. Conexión para manómetro hembra 1/4" ISO 228/1.

Safety relief angle valve with pressure gauge connection-3 bar (3191) Safety relief angle valve with pressure gauge connection-6 bar (3192)

Brass body. Stainless steel AISI 302 spring. EPDM joint. EPDM membrane. Male-female threaded ends ISO 228/1. Max. working pressure 10 bar. Max. working temp. 90°C. 1/4" female pressure gauge connection ISO 228/1.

L	H
47	75

3191 04	1/2"	0,140	10-100	8,59
3192 04	1/2"	0,114	10-100	8,59

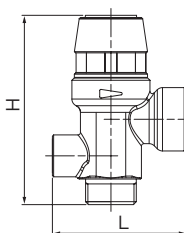

Ref. 3191E - 3192E



Válvula de seguridad con conexión y manómetro 3 bar (3191E) Válvula de seguridad con conexión y manómetro 6 bar (3192E)

PN 10. Construcción en latón UNE-EN 12165. Muelle de acero inoxidable AISI 302. Obturador y membrana en EPDM. Extremos roscados M-H ISO 228/1. Temp. máx. 90°C. Mando manual por volante de ABS. Manómetro Ø 53 indicador rojo, salida posterior.

Safety relief angle valve with pressure gauge 3 bar (3191E) Safety relief angle valve with pressure gauge 6 bar (3192E)

PN 10. Brass construction UNE-EN 12165. Stainless steel AISI 302 spring. EPDM joint and membrane. Threaded ends ISO 228/1 M-F. Max. temp. 90°C. ABS manual handwheel. Pressure gauge Ø 53, red index, back connection.

L	H
84	82

3191E 04	1/2"	0,181	-	13,21
3192E 04	1/2"	0,181	-	13,01

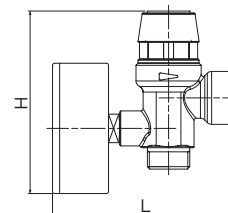

CÓDIGO CODE	MEDIDA SIZE	PESO WEIGHT	CAJA / BOX CARTON	P.V.P. € PRICE €
----------------	----------------	----------------	----------------------	---------------------

Ref. 73153



Unidad automática de llenado a pistón

PN 16. Construcción en latón niquelado UNE-EN 12165. Cierre acero inox. Extremos rosca gas (BSP) M-H s/ISO 228/1. Campo de regulación 0,5 - 4 bar. Manómetro conexión G1/4" escala 0-10 bar. Valvula antiretorno en el interior. Valvula de corte de suministro. Temperatura maxima de trabajo 80°C. Aplicación para agua

Automatic piston filling unit

PN 16. Nickel-plated brass construction UNE-EN 12165. Stainless steel sealing. Threaded ends gas (BSP) M - F acc/ISO 228/1. Adjustable range from 0,5 - 4 bar. Pressure gauge scale 0 - 10 bar with G1/4" connection . Inner check valve. Shut-off valve of power supply. Working temperature 80°C. Appliance for water

R	A	B	C	D
1/2"	55	55,7	46	59,6

73153 04 00	1/2"	0,542	12	47,99
-------------	------	-------	----	-------

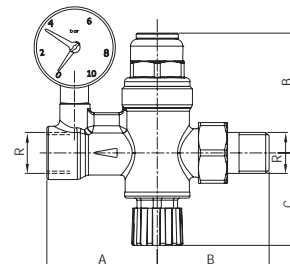

Ref. 70017



Purgador manual de aire orientable

PN 10. Construcción en latón UNE-EN 12164 niquelado. Juntas de cierre en EPDM. Orificio de purga orientable 360°. Conexión rosca gas (BSP) macho ISO 228/1. Temp. máx. trabajo 100°C.

Orientable manual air vent

PN 10. Nickel plated brass construction UNE-EN 12164. EPDM sealing O-rings. Vent hole orientable 360°. Gas threaded end (BSP) male, ISO 228/1. Max. working temp. 100°C

R	A	B	C	E (Hex)
1/8"	13	21	24	14

70017 01 00	1/8"	0,020	100-1000	1,10
-------------	------	-------	----------	------

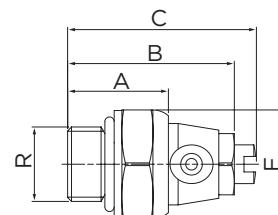

Ref. 70018



Purgador manual de aire

Cuerpo en latón niquelado. Mando de control no conductor de calor. Unión rosca macho ISO 228. Presión máx. 6 bar. Temp. máx 100°C.

Manual air vent

Nickel-plated brass body. Heatless control handle. Threads connection male ISO 228. Max. working pressure 6 bar. Max. working temp. 100°C.

R	D	A
1/8"	17,5	27

70018 01 02	1/8"	0,017	10-1000	0,86
-------------	------	-------	---------	------

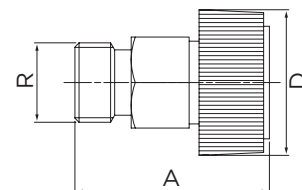

Ref. 71012



Purgador automático de aire

Cuerpo en latón niquelado. Junta en EPDM. Flotador en polietileno. Unión rosca M-ISO 228. Presión máx. 10 bar. Temp. máx. de trabajo 110°C.

Automatic air vent valve

Nickel-plated brass body. EPDM joint. Polyethylene float. Male thread connections ISO 228. Max. working pressure 10 bar. Max. working temp. 110°C.

R	A	B	C	D
G 1"	57,5	31	37,5	42

71012 06 02	DCHO./RIGHT	0,102	10-100	6,95
-------------	-------------	-------	--------	------

71012 06 13	IZQ./LEFT	0,102	10-100	6,95
-------------	-----------	-------	--------	------

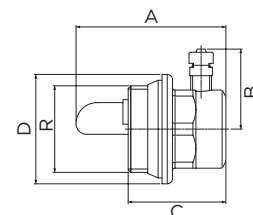

Ref. 70037



Purgador automático de aire

Cuerpo en latón. Sistema de flotador en PP. Junta de cierre en elastómero. Extremo rosca macho ISO 228/1. Temp. máx. 110°C. Presión máxima de trabajo 10 bar.

Automatic air vent

Body brass. PP floating system. Elastomer sealing joint. Male thread ISO 228/1. Max. working temp. 110°C. Maximum working pressure 10 bar.

R	D	H	a
3/8"	46	70	9
1/2"	46	70	9
3/4"	46	70	8,5
1"	51	73	13,5

70037 03 02	3/8"	0,146	1-192	6,35
-------------	------	-------	-------	------

70037 04 02	1/2"	0,157	1-192	7,01
-------------	------	-------	-------	------

70037 05 02	3/4"	0,154	1-192	10,21
-------------	------	-------	-------	-------

70037 06 02	1"	0,300	10-168	12,08
-------------	----	-------	--------	-------

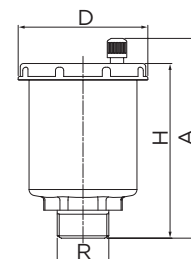

Ref. 70038



Purgador automático de aire con cierre manual y conexión lateral

Cuerpo en latón. Sistema de flotador en PP. Junta de cierre en elastómero. Extremo rosca macho ISO 228/1. Temp. máx. 115°C.

Automatic air vent with manual lockin plug and lateral connection

Body brass. PP floating system. Elastomer sealing joint. Male thread ISO 228/1. Max. working temp. 115°C.

R	A	D	H	L
G 3/8"	53	46	46	53
G 1/2"	53	46	46	55

CÓDIGO CODE	MEDIDA SIZE	PESO WEIGHT	CAJA / BOX CARTON	P.V.P. € PRICE €
----------------	----------------	----------------	----------------------	---------------------

70038 03 00	3/8"	0,026	10-80	8,85
70038 04 00	1/2"	0,047	10-80	10,62

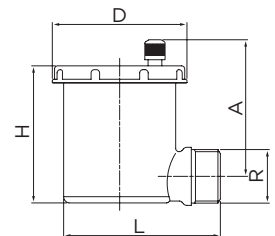

Ref. 70037



Degasificador automático

Cuerpo en latón niquelado. Flotador en PP. Junta de cierre en elastómero. Extremo rosca macho ISO 228/1. Temperatura máx. fluido 100°C. Presión máx. trabajo 6 bar. Presión máx. transitoria 16 bar.

Automatic degassing device

Nickle-plated brass body. PP float. Elastomer sealing joint. Male thread end ISO 228/1. Max. fluid temperature 100°C. Max. working pressure 6 bar. Max. transient pressure 16 bar.

Medida/Size	A	D
3/8"	109	48
1/5"	112	48
3/4"	114	48

70037 03 60	3/8"	0,255	4-40	25,11
70037 04 60	1/2"	0,266	4-40	28,10
70037 05 60	3/4"	0,267	4-40	28,63

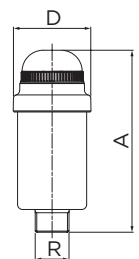

Ref. 3044



Válvula de descarga para caldera

PN 25. Paso total. Construcción en latón niquelado UNE-EN 12165. Asientos PTFE. Extremos rosca gas (BSP) M ISO 228/1 y conexión a manguera Ø 15 con tapón seguridad. Temp. máx. 110°C. Mando manual por palomilla aluminio color rojo.

Boiler discharge valve

PN 25. Full bore. Body brass UNE-EN 12165 Nickel-plated finishing. PTFE seats. Threaded end male ISO 228/1 and Ø 15 hose connection with safety cap. Max. Temp. 110°C. Aluminium butterfly red handle.

R x B	DN	H	L	M
G 1/2" x Ø15	10	34	72	35,5

3044 04	1/2" x Ø15	0,145	8-192	5,48
---------	------------	-------	-------	------

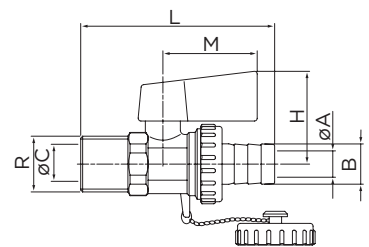

Ref. 70302

NEW



Válvula esfera escuadra con tuerca loca

PN 16. Paso total. Construcción en latón cromado según UNE-EN 12165. Asientos PTFE. Extremos roscados rosca gas (BSP) M-H - ISO 228/1. Temp. máx. 110°C. Mando manual por palanca de aluminio azul.

Ball angle valve with free nut

PN 16. Full bore. Body chrome plated brass UNE-EN 12165. PTFE seats. Gas threaded ends (BSP) M-F, ISO 228/1. Max. temp. 110°C. Blue aluminium butterfly handle.

R	P	A	L	M
1/2"	10	59	29	33

70302 04 00	1/2" x 1/2"	0,111	10-160	5,83
-------------	-------------	-------	--------	------

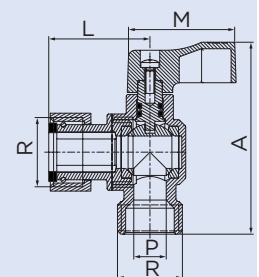

CÓDIGO CODE	MEDIDA SIZE	PESO WEIGHT	CAJA / BOX CARTON	P.V.P. € PRICE €
----------------	----------------	----------------	----------------------	---------------------

Ref. 70304

NEW

Valvula esfera escuadra con tuerca loca

PN 25 Paso total. Construcción en latón cromado según UNE-EN 12165. Asientos PTFE. Extremos roscados rosca gas (BSP) M-H - ISO 228/1. Temp. máx. 110°C. Mando manual por palanca de aluminio rojo.

Ball angle valve with free nut

PN 25. Full bore. Body chrome plated brass UNE-EN 12165. PTFE seats. Gas threaded ends (BSP) M-F, ISO 228/1. Max. temp. 110°C. Red aluminium butterfly handle.



R	P	A	L	M
3/4"	14	65	33	33

70304 05 00 3/4" x 3/4" 0,175 10-120 **7,34**

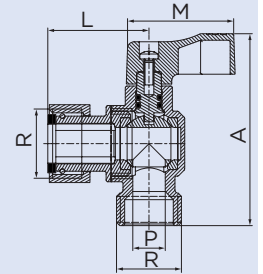

Ref. K3770

NEW

Kit de conexiones flexibles para caldera

Composición del kit:

- 2 unidades GECONNECT DN15 MH 1/2" para agua + juntas EPDM para la entrada de agua fría y salida que permite distribuir el agua hacia la ducha y los grifos de la vivienda. (Ref. 3770 04 20).
- 2 unidades GECONNECT DN20 MH 3/4" para agua + juntas EPDM envío y retorno de agua al circuito de calefacción. (Ref. 3770 05 20).
- 1 unidad GECONNECT GAS DN12 HH 1/2" x 3/4" para gas + juntas NBR para entrada gas, recubierta con funda de PVC de color blanco para gas, en cumplimiento con la norma UNE 60713 (Ref.3654 04 05).

Flexible connection kit for boilers

Kit composition:

- 2 units GECONNECT DN15 M-F 1/2" for water with EPDM joint. Ref. 3770 04 20.
- 2 units GECONNECT DN20 M-F 3/4" for water with EPDM joint. Ref. 3770 05 20.
- 1 unit GECONNECT GAS DN12 F-F 1/2" x 3/4" for gas with NBR joint.



K3770 00 - - 1-15 **63,50**

Ref. K3771

NEW

Kit Total de conexiones flexibles para caldera

Composición del kit:

- 2 unidades GECONNECT DN15 MH 1/2" para agua + juntas EPDM para la entrada de agua fría y salida que permite distribuir el agua hacia la ducha y los grifos de la vivienda. (Ref. 3770 04 20).
- 2 unidades GECONNECT DN20 MH 3/4" para agua + juntas EPDM envío y etorno de agua al circuito de calefacción. (Ref. 3770 05 20).
- 1 unidad GECONNECT GAS DN12 HH 1/2" x 3/4" para gas + juntas NBR para entrada gas, recubierta con funda de PVC de color blanco para gas, en cumplimiento con la norma UNE 60713 (Ref.3654 04 05).
- 1 Válvula M-H 1/2" x 1/2" (Ref. 70302 04 00).
- 2 Válvulas M-H 3/4" x 3/4" (Ref. 70304 05 00).

Flexible connection Kit for boilers with valves

Kit composition:

- 2 units GECONNECT DN15 M-F 1/2" for water with EPDM joint. Ref. 3770 04 20.
- 2 units GECONNECT DN20 M-F 3/4" for water with EPDM joint. Ref. 3770 05 20.
- 1 unit GECONNECT GAS DN12 F-F 1/2" x 3/4" for gas with NBR joint. Ref. 3654 04 05.
- 1 unit ball angle valve with free nut M-H 1/2" x 1/2" (Ref. 70302 04 00).
- 2 units ball angle valve with free nut M-H 3/4" x 3/4" (Ref. 70304 05 00).



K3771 00 - - 1-15 **82,68**

Ref. 73070

Filtro magnético para calderas "GE-Safe"

Filtro magnetico compacto para calderas. Cuerpo de poliamida PA66 + 33%FV. Filtro de 800 micras de acero inoxidable AISI 304. Conexiones M - G3/4" UNE-EN ISO 228. Elemento magnetico Neodimio REN35 11.000 Gauss. Maxima presión de trabajo 3 bar. Temperatura maxima de trabajo 90°C

"GE- Safe" magnetic filter for boilers

Compact magnetic filter for boilers. Body construction in polyamide PA66 + 33%FV. Stainless steel filter AISI 304, 800 microns. Connection M - G3/4" UNE-EN ISO 228. Magnetic element Neodymium RE35 11.000 Gauss. Maximum working pressure 3 bar. Maximum working temperature 90°C



R	A	B	C	D
3/4"	185,4	112	64	92,5

73070 05 00 3/4" 0,492 8 **110,93**

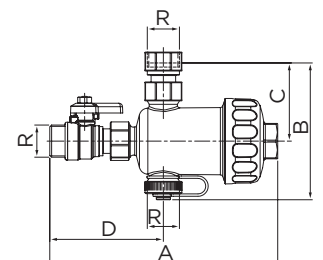

Ref. 73286



Filtro para calderas de condensación "GE-Clean"

Filtro neutralizador para los condensados de calderas de baja potencia (24 - 35 KW). Cuerpo de PA piliamida transparente. Filtro de acero inoxidable AISI 304. Brida de sujección a pared. Conectores "L" codo G3/4" x DN20. Dos cargas de carbonato calico (Ca CO₃).

"GE-Clean" filter for condensing boilers

Acid condensation neutralising filter for low-power boilers (24- 35 KW). Body construction in transparent PA polyamide. Stainless steel filter AISI 304. Wall fixing bracket. "L" elbow connector G3/4" x DN20. Two neutralising loads of calcium carbonate (Ca CO₃).

Recambios

Carga de carbonato calcico (Ca CO₃) - R73286

Spare parts

Neutralising refill of calcium carbonate (Ca CO₃) - R73286

R	A	B	C	D
3/4" x 20	160	136	70	59,6

CÓDIGO CODE	MEDIDA SIZE	PESO WEIGHT	CAJA / BOX CARTON	P.V.P. € PRICE €
----------------	----------------	----------------	----------------------	---------------------

73286 05 00	3/4" x 20	0,196	1	67,09
-------------	-----------	-------	---	-------

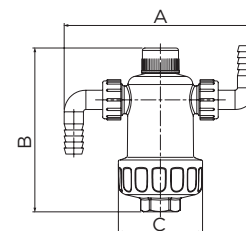

R73286 00 00	-	0,118	10	8,97
-----------------	---	-------	----	------

Ref. 72319

NEW



Filtro magnetico multifunción "GE-Safe"

Filtro multifunción. Cuerpo de poliamida PA66 + 33%FV. Filtro de 800 micras de acero inoxidable AISI 304. Conexiones H - H G3/4" según ISO 228/1. Elemento magnetico Neodimio REN35 11.000 Gauss. Máxima presión de trabajo 4 bar. Temperatura máxima de trabajo 90°C.

"GE-Safe" multifunction magnetic filter

Multifunction filter. Body construction in polyamide PA66 + 33%FV. Stainless steel filter AISI 304, 800 microns. Connection F - F G3/4" according ISO 228/1. Magnetelement Neodymium REN35 11.000 Gauss. Maximum working pressure 4 bar. Maximum working temperature 90°C.

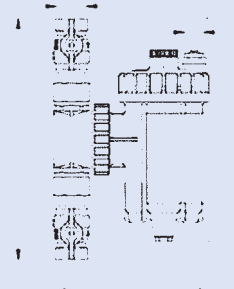

72319 06 50	1"	-	1-1	231,58
-------------	----	---	-----	--------

72319 07 50	1 1/4"	-	1-1	273,14
-------------	--------	---	-----	--------

Ref. 73541

NEW



Filtro magnetico autolimpiante para central termica

Filtro autolimpiante magnetico para sala de calderas. Cuerpo de acero pintado. Filtro de 100 micras de acero inoxidable AISI 304. Conexiones mediante bridas DIN PN16. Elemento magnetico Neodimio 12.000 Gauss. Maxima presión de trabajo 10 bar. Temperatura maxima de trabajo 95°C.

Self cleaning filter with magnetic separator for boiler room

Self-cleaning filter with magnetic separator for boiler room. Main body and flanges steel painted. Stainless steel filter 100 microns. Flanged PN16 connections. Magnetic elements Neodymium 12.000 Gauss. Maximum working pressure 10 bar. Maximum working temperature 95°C.

DN	A	H	H1	H2	B
DN50	573	1060	450	385	220

73541 09 10	DN50	-	1-1	4109,83
-------------	------	---	-----	---------

73541 10 10	DN65	-	1-1	4574,10
-------------	------	---	-----	---------

73541 11 10	DN80	-	1-1	4934,45
-------------	------	---	-----	---------

73541 12 10	DN100	-	1-1	5438,85
-------------	-------	---	-----	---------

73541 13 10	DN125	-	1-1	7229,15
-------------	-------	---	-----	---------

73541 14 10	DN150	-	1-1	8336,47
-------------	-------	---	-----	---------

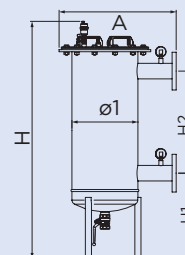

Ref. 73601

NEW



Carcasa aislamiento anti condensación

Aislamiento térmico compuesto por semicarcasas y cubierta de polietileno expandido con revestimiento externo de película antiarañazos. Comportamiento al fuego clase I. Densidad 33 Kg/mm³. Temperatura máxima -40° a +90°.

Anti-condensation insulation casing

Thermal insulation consisting of semi-casings and expanded polyethylene cover with external anti-scratch film coating. Fire behaviour class I. Density 33 Kg/mm³. Max operating temperature -40° to +90°.

73601 09 02	DN50	-	1-1	278,73
-------------	------	---	-----	--------

73601 10 10	DN65	-	1-1	432,53
-------------	------	---	-----	--------

73601 11 10	DN80	-	1-1	432,53
-------------	------	---	-----	--------

73601 12 10	DN100	-	1-1	432,53
-------------	-------	---	-----	--------

73601 13 10	DN125	-	1-1	836,24
-------------	-------	---	-----	--------

73601 14 10	DN150	-	1-1	836,24
-------------	-------	---	-----	--------

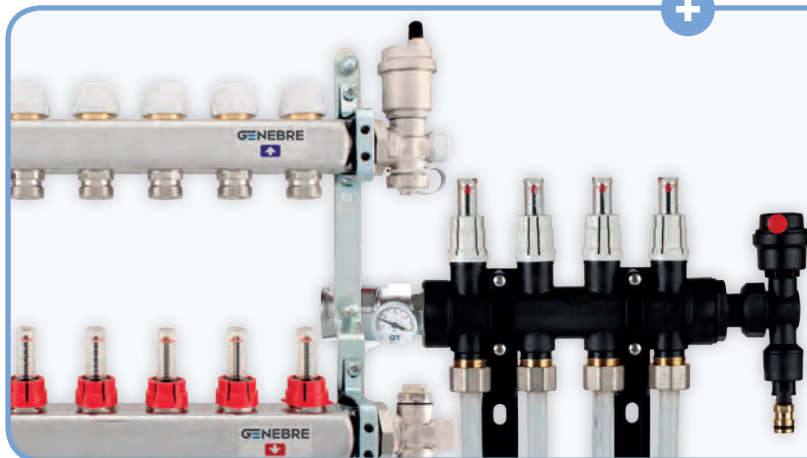

SUELO RADIANTE UNDERFLOOR HEATING

Ref. 71411

NEW

Colector de polímero

PN 8. Cuerpo de polímero Pa66 + 30% FV. Valvulas termostaticables y conexiones de latón según UNE-EN 12165. Juntas de EPDM. Extremos roscados rosca gas (BSP) ISO 228/1. Conexión en línea hembra G1", derivaciones laterales rosca macho G3/4" euroconus. Numero de vias; 3 a 14. Mandos y tapas de polímero. Presión máxima de trabajo 8 bar. Temperatura máx. 80°C.

Polymer manifold

PN 8. polymer body construction Pa66 + 30% GF. Brass thermostatic valve and conexions UNE-EN 12165. EPDM joints. Gas threaded ends (BSP) ISO 228/1. Conections line, male 1", derivation connections male G3/4" euroconus. Derivation connections 3 up to 14 ways. Polymer hand wheels and caps. Maximum working pressure 8 bar. Maximum working temperature 80°C.



Salidas/Ways	R	r	A	B
3	1"	3/4"	370	188
4	1"	3/4"	420	238
5	1"	3/4"	470	288
6	1"	3/4"	520	338
7	1"	3/4"	570	388
8	1"	3/4"	620	438
9	1"	3/4"	670	488
10	1"	3/4"	720	538
11	1"	3/4"	830	648
12	1"	3/4"	880	698
13	1"	3/4"	930	748
14	1"	3/4"	980	798

CÓDIGO CODE	MEDIDA SIZE	PESO WEIGHT	CAJA / BOX CARTON	P.V.P. € PRICE €
71411 06 03	1" x 3/4"	3,065	1-1	246,24
71411 06 04	1" x 3/4"	2,970	1-1	283,07
71411 06 05	1" x 3/4"	3,47	1-1	313,47
71411 06 06	1" x 3/4"	-	1-1	319,00
71411 06 07	1" x 3/4"	4,07	1-1	351,76
71411 06 08	1" x 3/4"	4,305	1-1	381,35
71411 06 09	1" x 3/4"	4,515	1-1	411,68
71411 06 10	1" x 3/4"	-	1-1	440,55
71411 06 11	1" x 3/4"	5,855	1-1	513,86
71411 06 12	1" x 3/4"	6,055	1-1	583,68
71411 06 13	1" x 3/4"	6,270	1-1	610,54
71411 06 14	1" x 3/4"	-	1-1	643,94

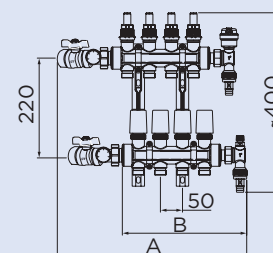

Ref. 71410

NEW

Colector de acero inoxidable

PN 6. Cuerpo en acero inoxidable AISI 304L. Valvulas termostaticables y conexiones de latón según UNE-EN 12165. Juntas de EPDM. Extremos roscados rosca gas (BSP) ISO 228/1. Conexión en línea hembra G1", derivaciones laterales rosca macho G3/4" euroconus. Numero de vias; 3 a 12. Mandos y tapas de polímero. Presión máxima de trabajo 6 bar. Temperatura máx. 70°C.

Stainless steel manifold

PN 6. Body construction stainless steel AISI 304L. Brass thermostatic valve and conexions UNE-EN 12165. EPDM joints. Gas threaded ends (BSP) ISO 228/1. Conections line, male 1", derivation connections male G3/4" euroconus. Derivation connections 3 up to 12 ways. Polymer hand wheels and caps. Maximum working pressure 6 bar. Maximum working temperature 70°C.

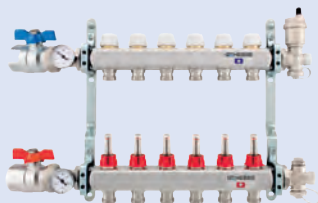

Salidas/Ways	R	r	A	B
3	1"	3/4"	358	193
4	1"	3/4"	408	243
5	1"	3/4"	458	293
6	1"	3/4"	508	343
7	1"	3/4"	558	393
8	1"	3/4"	608	443
9	1"	3/4"	658	493
10	1"	3/4"	708	543
11	1"	3/4"	758	593
12	1"	3/4"	808	643
13	1"	3/4"	858	693

71410 06 03	1" x 3/4"	3,560	1-1	239,75
71410 06 04	1" x 3/4"	3,964	1-1	268,45
71410 06 05	1" x 3/4"	4,352	1-1	298,17
71410 06 06	1" x 3/4"	4,720	1-1	311,96
71410 06 07	1" x 3/4"	5,245	1-1	353,52
71410 06 08	1" x 3/4"	5,540	1-1	393,88
71410 06 09	1" x 3/4"	5,944	1-1	429,57
71410 06 10	1" x 3/4"	6,272	1-1	462,98
71410 06 11	1" x 3/4"	6,732	1-1	493,09
71410 06 12	1" x 3/4"	7,166	1-1	522,71
71410 06 13	1" x 3/4"	7,526	1-1	552,45

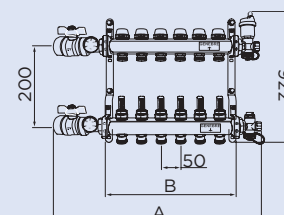

CÓDIGO CODE	MEDIDA SIZE	PESO WEIGHT	CAJA / BOX CARTON	P.V.P. € PRICE €
----------------	----------------	----------------	----------------------	---------------------

Ref. 70224

NEW

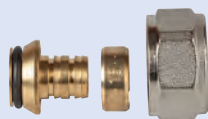

Racor tubo multicapa Euroconus rosca G3/4"

Construcción en latón. Tuerca niquelada. Cierre de elastomero. Rosca hembra gas (BSP) G3/4" según ISO 228/1. Temperatura máxima de trabajo 95°C. Presión máxima de trabajo 10 bar

Euroconus multilayer pipe fitting G3/4" threaded

Brass construction. Nickel plated nut. Elastomer sealing. Female gas (BSP) thread G3/4". Maximum working temperature 95°C. Maximum working pressure 10 bar

70224 16 00	Ø16 x 2	0,078	10-300	4,40
-------------	---------	-------	--------	-------------



Ref. 70246

NEW



LLave para racor rosca Euroconus

Llave con conexión angular para apretar fácilmente en montaje en cualquier posición. Para racor Euroconus G3/4" gas (BSP) según ISO 228/1.

Spanner for fitting Euroconus

Angled connection spanner for easily tighten fittings in any position. For Euroconus G3/4" gas threaded (BSP) ISO 228/1.

70246 00 00	Ch 30	0,100	1-1	16,46
-------------	-------	-------	-----	--------------



Ref. K3046B - K3046R

NEW



Kit conector colector agua fría (K3046B) y agua caliente (K3046R)

Consta de tres partes principales, la válvula de esfera, el conector y el termómetro. PN 25. Paso total. Construcción en latón según UNE-EN 12165 cromado. Juntas de NBR. Extremos roscados rosca gas (BSP) ISO 228/1. Termómetro bimetalico de rango 0- 80°C. Presión máxima de trabajo 25 bar. Temperatura máx. 80°C. Mando manual por palomilla de aluminio color azul (K3046B) y palomilla color rojo (K3046R).

Connector kit for manifold cold water (K3046B) and hot water (K3046R)

Consists of three main parts, the ball valve, the connector and the thermometer. PN 25. Full bore. Body chrome-plated brass UNE-EN 12165. NBR joints. Gas threaded ends (BSP) ISO 228/1. Bimetallic thermometer range 0-80°C. Maximum working pressure 25 bar. Maximum working temperature 80°C. Blue aluminium butterfly handle (K3046B) and red butterfly handle (K3046R).

K3046B	1"	0,585	1-32	33,80
--------	----	-------	------	--------------

K3046R	1"	0,585	1-32	33,80
--------	----	-------	------	--------------

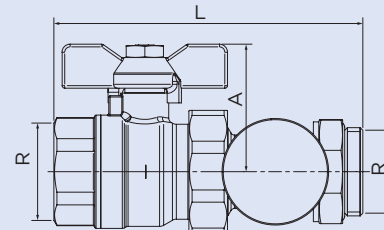

Ref. 70306

NEW



Actuador electrotérmico

Alimentación: 24V / 220-240V (±10%) 50-60 Hz. P=1,2W. Construcción en polímero ignífugo, cable de 2 hilos, funda de PVC. Posición de la válvula n/c. Clase de protección IP54. Temperatura ambiente máx. de trabajo 60°C. Temperatura máx. del fluido 100°C. Presión máx. de trabajo 10 bar.

Electrothermal actuator

Power supply: 24V / 220-240V (±10%) 50-60 Hz. P=1,2W. Fireproof polymer construction. Two wire cable with PVC cover. Normally closed valve position. Protection class IP54. Max. working ambient temperature 60°C. Max. fluid temperature 100°C. Max. working pressure 10 bar.

70306 00 02	M30 x 1,5	0,100	1-100	25,82
-------------	-----------	-------	-------	--------------

70306 00 12	M30 x 1,5	0,115	1-100	25,82
-------------	-----------	-------	-------	--------------

Ref.	Alimentación/ Power supply
70306 00 02	220/230 V
70306 00 12	24 V

CÓDIGO CODE	MEDIDA SIZE	PESO WEIGHT	CAJA / BOX CARTON	P.V.P. € PRICE €
----------------	----------------	----------------	----------------------	---------------------

Ref. **73189**

NEW

Actuador electrotérmico con microrruptor auxiliar

Alimentación: 220-240V (±10%) 50-60 Hz. P=1,2W. Construcción en polímero ignífugo, cable de 4 hilos, funda de PVC. Posición de la válvula n/c. Clase de protección IP54. Temperatura ambiente máx. de trabajo 60°C. Presión máx. de trabajo 10 bar.

Electothermal actuator with auxiliar microswitch

Power supply: 220-240V (±10%) 50-60 Hz. P=1,2W. Fireproof polymer construction. 4 wire cable with PVC cover. Normally closed valve position. Protection class IP54. Max. environment working temperature 60°C. Max. working pressure 10 bar.



73189 00 42	M30 x 1,5	-	1-1	45,60
-------------	-----------	---	-----	--------------

Ref. **72606**

Caja metálica para colectores componibles

Caja de inspección con cuerpo de acero galvanizado. Tapa extraíble de material plástico pintable. Con guías móviles. Profundidad regulable 80 - 150 mm.

Metal box for modular manifold

Metal galvanized box. Removable cover of paintable plastic. With mobile bracket guides inside. Adjustable depth 80 - 150 mm.



72606 40 02	400x500	-	1	65,83
72606 60 02	600x500	-	1	79,45
72606 80 02	800x500	-	1	95,38
72606 10 02	1000x500	-	1-1	136,26

Ref. **72190**

Bridas metálicas para colectores

Par de bridas de acero para fijar los colectores en cajas metálicas. Distancia entre centros 220 mm.

Steel brackets for manifold

Pair of steel brackets to fixing the manifolds in metal boxes. Center distances 220 mm.



72190 06 00	1"	0,682	2-20	13,44
-------------	----	-------	------	--------------



Válvulas de equilibrado Balancing valves

La válvula de equilibrado es un dispositivo con la función de ajuste y medida del fluido en tránsito, sea frío o caliente, para sistemas abiertos o cerrados con las siguientes ventajas:

- 1 Mantiene el caudal dentro del valor deseado dentro de un amplio intervalo de presión diferencial entre aguas arriba y aguas abajo.
- 2 Ajuste micrométrico del fluido en tránsito.
- 3 Indicador de calibración mediante volante graduado.
- 4 No requiere mantenimiento.

The balancing valve is a single component device having adjustment functions and that measures cold and hot fluids transiting inside closed and open systems with following advantages:

- 1 Maintaining a constant flow rate at the device value, within a differential pressure range between upstream and downstream
- 2 Micrometric adjustment of the fluid in transit.
- 3 Calibration indicator by graduated handwheel.
- 4 Does not require maintenance.

Ref. 3074

NEW



Válvula equilibrado estático

PN16. Construcción cuerpo y componentes internos en latón UNE-EN 12165. Extremos rosca gas (BSP) H-H, ISO 228/1. Juntas de EPDM. Doble regulación. Tomas de presión G1/4" incluidas. Temperatura de trabajo -20°C a 120°C.

Static balancing valve

PN 16. Body brass construction UNE-EN 12165. Gas threaded ends (BSP) ISO 228/1. EPDM sealing. Double regulation. Pressure inlets G1/4" included. Working temperature -20°C a 120°C.

R	L	H
1/2"	77	88
3/4"	84	90
1"	91	93
1 1/4"	110	98

CÓDIGO CODE	MEDIDA SIZE	PESO WEIGHT	CAJA / BOX CARTON	P.V.P. € PRICE €
3074 04	1/2"	0,540	1-1	39,81
3074 05	3/4"	0,650	1-1	47,41
3074 06	1"	0,700	1-1	50,40
3074 07	1 1/4"	0,980	1-1	69,18

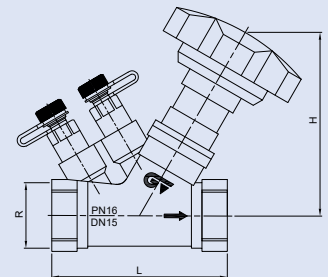

Ref. 2228

Válvula de equilibrado estático - Bridas DIN PN 16

Const. cuerpo y bonete fundición nodular GGG-40. Eje acero inoxidable. Cierre en EPDM. Orificio variable. Doble regulación. Temperatura de trabajo -10°C +120°C.

Static balancing valve - Flanged ends DIN PN 16

Body and bonnet of ductil iron GGG-40. Stainless steel stem. Sealing: EPDM. Variable orifice. Double regulation. Working temperature -10°C +120°C.

Medida/Size	DN	D	L	A	V
2"	50	165	230	276	180
2 1/2"	65	185	290	308	180
3"	80	200	310	320	180
4"	100	220	350	340	180
5"	125	250	400	375	180
6"	150	285	480	410	180
8"	200	340	600	550	350
10"	250	405	730	590	350
12"	300	460	850	678	450

2228 09	2"	11,400	-	305,16
2228 10	2 1/2"	16,375	-	338,69
2228 11	3"	19,580	-	411,06
2228 12	4"	25,928	-	505,82
2228 13	5"	41,000	-	736,02
2228 14	6"	54,316	-	986,74
2228 16	8"	103,000	-	1778,56
2228 18	10"	151,500	-	2828,16
2228 20	12"	221,000	-	3999,53

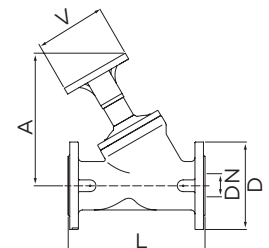

Ref. 73717M

NEW

Unidad Fan Coil Manual (FCU)

PN25. Construcción en latón DZR, según UNE-EN 12165. Asientos PTFE y EPDM PEROXIDO. Extremos rosca gas (BSP) ISO 228/1. Rango de temperatura -10°C a 120°C. La unidad FCU se compone de una válvula manual, un filtro tamiz de 800 micras con punto de drenaje, válvulas de aislamiento con by-pass y una estación Venturi con tomas de presión P/T. Caja de aislamiento de polietileno incluida.

Manual Fan Coil Unit (FCU)

PN 25. DZR brass construction UNE-EN 12165. PTFE and EPDM PEROX seats. Gas threaded ends (BSP) ISO 228/1. Temperature range -10°C to 110°C. The FCU has composed by manual valve, 800 microns filter with flushing, by pass isolation valves and a venturi metering station with P/T plugs. Polyethylene insulation box included.

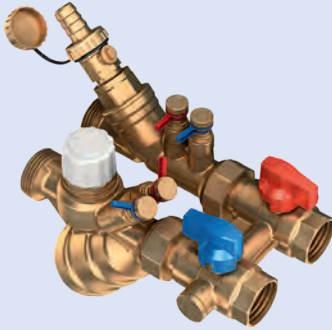

CÓDIGO CODE	MEDIDA SIZE	PESO WEIGHT	CAJA / BOX CARTON	P.V.P. € PRICE €
----------------	----------------	----------------	----------------------	---------------------

73717M 05 00	3/4"	2,131	1	327,37
73717M 05 10	3/4"	2,131	1	327,37
73717M 05 20	3/4"	2,131	1	327,37

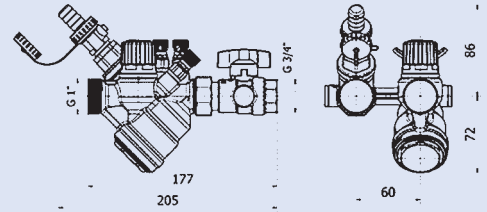

Ref. 73717A

NEW

Unidad Fan Coil Motorizada (FCU)

PN25. Construcción en latón DZR, según UNE-EN 12165. Asientos PTFE y EPDM PEROXIDO. Extremos rosca gas (BSP) ISO 228/1. Rango de temperatura -10°C a 120°C. La unidad FCU se compone de una válvula de control PICV motorizada, un filtro tamiz de 800 micras con punto de drenaje, válvulas de aislamiento con by-pass y una estación Venturi con tomas de presión P/T. Caja de aislamiento de polietileno incluida.

Motorized Fan Coil Unit (FCU)

PN 25. DZR brass construction UNE-EN 12165. PTFE and EPDM PEROX seats. Gas threaded ends (BSP) ISO 228/1. Temperature range -10°C to 110°C. The FCU has composed by PICV control valve with actuator, 800 microns filter with flushing, by pass isolation valves and a venturi metering station with P/T plugs. Polyethylene insulation box included.

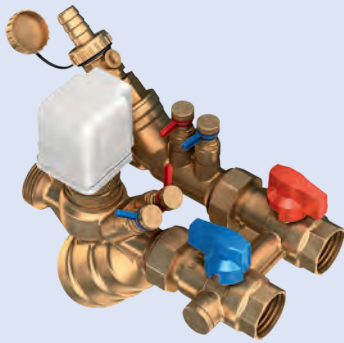

73717A 05 00	3/4"	2,131	1	346,15
73717A 05 10	3/4"	2,131	1	346,15
73717A 05 20	3/4"	2,131	1	346,15

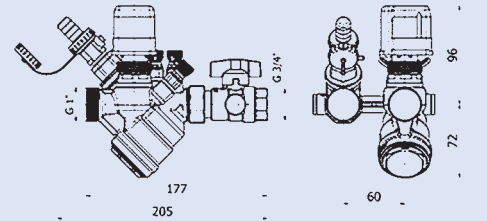

Ref. 70874

Válvula de equilibrado dinámico

PN 16. Construcción en latón s/UNE-EN 12165. Cartucho de polímero con membrana de EPDM. Extremos rosca gas (BSP) H - H s/ISO 228/1. Indicador mediante escala graduada. Tomas de presión roscadas G1/8" hembra. Temperatura de trabajo de -20°C a 120°C. Aplicación con agua y agua + glicol (50%).

Dynamic balancing valve

PN 16. Brass construction acc/UNE-EN 12165. Polymer cartridge with EPDM diaphragm. Threaded ends gas (BSP) F - F acc/ISO 228/1. Indicator with graduated scale. Pressure taps connection G1/8" female. Working temperature from -20°C to 120°C. Appliance with water & water + glycol (50%).



R	A	B	C	D	E
1/2"	83	104	26,6	79	105,6
3/4"	95,1	106	26,6	79	105,6
1"	102	100	26,6	79	105,6

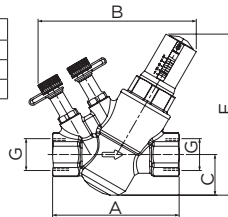

70874 04 10	1/2"	0,495	1	125,84
70874 04 20	1/2"	0,495	1	132,16
70874 04 30	1/2"	0,495	1	125,84
70874 04 40	1/2"	0,495	1	132,16
70874 05 10	3/4"	0,570	1	135,50
70874 05 20	3/4"	0,570	1	135,50
70874 05 30	3/4"	0,570	1	135,50
70874 05 40	3/4"	0,570	1	129,04
70874 06 10	1"	0,635	1	145,62
70874 06 20	1"	0,635	1	145,62
70874 06 30	1"	0,635	1	145,62
70874 06 40	1"	0,635	1	138,66

Ref. 78454



Cartuchos para válvula de equilibrado (art. 70874)

Cartuchos regulables para válvula de equilibrado

Cartridge for balancing valve (art. 70874)

Cartridge for automatic flow control valve

Ref.	Color	Rango caudal / Flow rate (m3/h)
78454 05 00	Negro/ Black	0,100 - 0,412
78454 15 00	Verde / Green	0,157 - 0,609
78454 25 00	Rojo Blanco / Red White	0,275 - 0,825
78454 55 00	Rojo Gris / Red Grey	0,406 - 1,270

CÓDIGO CODE	MEDIDA SIZE	PESO WEIGHT	CAJA / BOX CARTON	P.V.P. € PRICE €
-------------	-------------	-------------	-------------------	------------------

78454 05 00	-	0,060	8-1	65,89
78454 15 00	-	0,060	8-1	65,89
78454 25 00	-	0,060	8-1	65,89
78454 55 00	-	0,060	8-1	65,89

Ref. 72961



Llave para regulación de cartuchos válvula de equilibrado (art. 70874)

Permite ajustar el ratio de caudal deseado de los cartuchos regulables en la válvula de equilibrado

Spanner for cartridge adjustment. for balancing valve (art. 70874)

It allows adjusting the flow rate to the desired value by acting on the cartridge of balancing valve

72961 00 00	-	0,008	1	2,70
-------------	---	-------	---	------

Ref. 70621



Tomas de presión para válvula de equilibrado

Toma de presión para válvulas de equilibrado 3073 y 70874, para realizar la lectura indirecta del flujo de transferencia.

Pressure inlets for balancing valve

Inlet to be set up on threaded 3073 and 70874 balancing valves, used for indirect reading of transfer flow rate.

70621 01 50	1/8"	0,001	10-1	40,81
-------------	------	-------	------	-------

Ref. T3074



Tomas de presión para válvula de equilibrado

Toma de presión para válvula de equilibrado 3074, para realizar la lectura indirecta del flujo de transferencia.

Pressure inlets for balancing valve

Inlet to be set up on threaded 3074 balancing valve, used for indirect reading of transfer flow rate.

T3074	1/4"	-	-	8,65
-------	------	---	---	------

Ref. T2228



Tomas de presión para válvula de equilibrado

Toma de presión para válvula de equilibrado 2228, para realizar la lectura indirecta del flujo de transferencia.

Pressure inlets for balancing valve

Inlet to be set up on threaded 2228 balancing valve, used for indirect reading of transfer flow rate.

T2228	1/4"	0,150	-	11,31
-------	------	-------	---	-------

CÓDIGO CODE	MEDIDA SIZE	PESO WEIGHT	CAJA / BOX CARTON	P.V.P. € PRICE €
----------------	----------------	----------------	----------------------	---------------------

Ref. 79320



Agujas para la medición de presión. Para válvula de equilibrado

Cuerpo adaptador construido en latón. Agujas de acero. Conexión roscada G1/8" hembra ISO 228. Máx. presión de trabajo 16 bar. Máx. temperatura de trabajo 120°C

Needle adapters to measure pressure. For balancing valve
Adapters brass body. Steel needle. G1/8" female threaded end ISO 228. Max. working pressure 16 bar. Max. working temperature 120°C

79320 00 00	1/8"	0,036	30-1	23,50
-------------	------	-------	------	-------

Ref. 73566



Equipo electrónico para medición de la presión diferencial

Equipo electrónico para la medición de la presión diferencial por lectura directa del valor de caudal y la presión en circuitos hidráulicos. Baterías incluidas. Estuche con kit para la conexión a tomas piezométricas.

Electronic differential pressure measuring device

Electronic differential pressure measuring instrument suitable for the direct reading of flow rate and pressure valve on water circuits. Battery power supply. Complete with case and kits for connection to piezometric sockets.

73566 00 00	-	-	-	5514,41
-------------	---	---	---	---------

Ref. 3073



Válvula de equilibrado estático

PN 20. Construcción cuerpo y componentes internos en latón. Juntas VITON. Extremos rosca gas (BSP) H-H, ISO 228/1. Toma de presión G 1/8" H. Temperatura trabajo de -30°C a 120°C.

Static balancing valve

PN 20. Brass construction of body and inner components. Gas threaded ends (BSP) F-F, ISO 228/1. Pressure taps connection G 1/8" F. Working temperature from -30°C to 120°C.

R	A	B	C	D
1/2"	84	15	96	22
3/4"	85,6	17,8	97	21,5
1"	98	21,3	103,3	29,5
1 1/4"	101	28	111	29
1 1/2"	107	31	120	27
2"	115	37	132	21,9

3073 04	1/2"	0,480	1	41,70
3073 05	3/4"	0,477	1	42,41
3073 06	1"	0,680	1	53,37
3073 07	1 1/4"	0,930	1	59,73
3073 08	1 1/2"	1,180	1	83,49
3073 09	2"	1,547	1	128,96

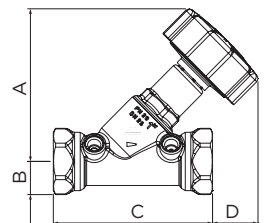

Ref. 4790



Válvula motorizada - zona 2 vías con cable de 2 hilos

Construcción en latón. Extremos rosca GAS hembra ISO 228/1. Aplicación agua fría o caliente. Temperatura fluido <94°C. Temperatura ambiente <40°C. Tensiones 220-240 VAC (±10%) 50-60 Hz. Presión nominal 16 bar. Clase de protección IP20. Palanca para accionamiento manual con muelle de retorno.

2 ways motorised - zone valve with 2 cores wire

Brass construction. Female threaded ends ISO 228/1. Application cold or hot water. Fluid temperature <94°C. Environment temperature <40°C. Voltage 220-240 VAC (±10%) 50-60 Hz. Nominal pressure 16 bar. IP20 protection class. Manual operating lever with spring return.

Ref.	A	B	C	D	H	L
4790 04	76	60	54	18	92	89
4790 05	76	60	54	18	92	93
4790 06	76	60	54	23	96	94

4790 04	1/2"	0,790	1-20	67,98
4790 05	3/4"	0,830	1-20	71,83
4790 06	1"	1,009	1-20	79,51

Recambio: art. 4795 / Spare parts: art. 4795

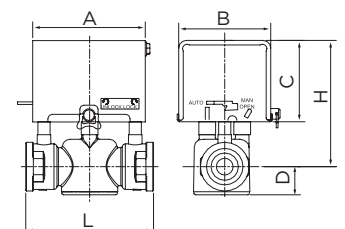

Ref. 4791



Válvula motorizada - zona 3 vías con cable de 2 hilos

Construcción en latón. Extremos rosca GAS hembra ISO 228/1. Aplicación agua fría o caliente. Temperatura fluido <94°C. Temperatura ambiente <40°C. Tensiones 220-240 VAC (±10%) 50-60 Hz. Presión nominal 16 bar. Clase de protección IP20. Palanca para accionamiento manual con muelle de retorno.

3 ways motorised - zone valve with 2 cores wire

Brass construction. Female threaded ends ISO 228/1. Application cold or hot water. Fluid temperature <94°C. Environment temperature <40°C. Voltage 220-240 VAC (±10%) 50-60 Hz. Nominal pressure 16 bar. IP20 protection class. Manual operating lever with spring return.

Ref.	A	B	C	E	H	L
4791 04	76	60	54	26,5	92	89
4791 05	76	60	54	26,5	92	93
4791 06	76	60	54	43	96	94

CÓDIGO CODE	MEDIDA SIZE	PESO WEIGHT	CAJA / BOX CARTON	P.V.P. € PRICE €
4791 04	1/2"	0,835	1-20	71,83
4791 05	3/4"	0,842	1-20	73,75
4791 06	1"	1,045	1-20	83,36

Recambio: art. 4795. / Spare parts: art. 4795

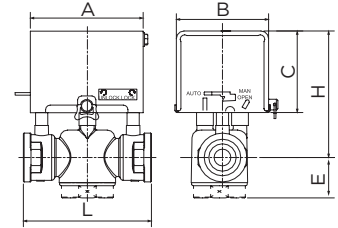

Ref. 4792



Válvula motorizada-zona 2 vías con cable de 5 hilos

Construcción en latón. Extremos rosca GAS hembra ISO 228/1. Aplicación agua fría o caliente. Temperatura fluido <94°C. Temperatura ambiente <40°C. Tensiones 220-240 VC (±10%) 50-60 Hz. Presión nominal 16 bar. Clase de protección IP20. Palanca para accionamiento manual con muelle de retorno.

2 way motrized-zone valve with 5 cores wire

Brass construction. Female threaded ends ISO 228/1. Application cold or hot water. Fluid temperature <94°C. Environment temperature <40°C. Voltage 220-240 VAC (±10%) 50-60 Hz. Nominal pressure 16 bar. IP20 protection class. Manual operating lever with spring return.

Ref.	A	B	C	D	H	L
4792 04	76	60	54	18	92	89
4792 05	76	60	54	18	92	93
4792 06	76	60	54	23	96	94

4792 04	1/2"	0,902	1-20	75,67
4792 05	3/4"	0,923	1-20	79,51
4792 06	1"	1,110	1-20	87,20

Recambio: art. 4795. / Spare parts: art. 4795

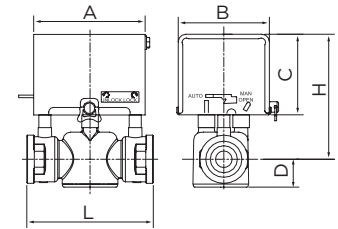

Ref. 4793



Válvula motorizada-zona 3 vías con cable de 5 hilos

Construcción en latón. Extremos rosca GAS hembra ISO 228/1. Aplicación agua fría o caliente. Temperatura fluido <94°C. Temperatura ambiente <40°C. Tensiones 220-240 VAC (±10%) 50-60 Hz. Presión nominal 16 bar. Clase de protección IP20. Palanca para accionamiento manual con muelle de retorno.

3 way motrized-zone valve with 5 cores wire

Brass construction. Female threaded ends ISO 228/1. Application cold or hot water. Fluid temperature <94°C. Environment temperature <40°C. Voltage 220-240 VAC (±10%) 50-60 Hz. Nominal pressure 16 bar. IP20 protection class. Manual operating lever with spring return.

Ref.	A	B	C	E	H	F
4793 04	76	60	54	26,5	92	89
4793 05	76	60	54	26,5	92	93
4793 06	76	60	54	43	96	94

4793 04	1/2"	0,985	1-20	79,51
4793 05	3/4"	0,985	1-20	81,44
4793 06	1"	1,140	1-20	91,04

Recambio: art. 4795. / Spare parts: art. 4795

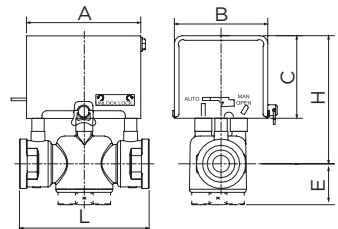

Ref. 4795

NEW

Recambio actuador para válvulas de zona-motorizadas

Recambio actuador para válvulas de zona-motorizadas. Tensiones 220-240 VAC (±10%) 50-60 Hz. Potencia 6.6 W. Temperatura ambiente <40°C. Clase de protección IP20. Palanca para accionamiento manual con muelle de retorno. Compatible para 1/2" - 3/4" - 1".

4795 22: 2 cables - 2 vías, para artículo 4790

4795 23: 2 cables - 3 vías, para artículo 4791

4795 52: 5 cables - 2 vías, para artículo 4792

4795 53: 5 cables - 3 vías, para artículo 4793

Motorized-zone valve actuator spare part

Motorized-zone valve actuator spare part. Voltage 220-240 VAC (±10%) 50-60 Hz. Power 6.6 W. Environment temperature <40°C. IP20 protection class. Manual operating lever with spring return. Available to 1/2" - 3/4" - 1".

4795 22: 2 wire - 2 way, to article 4790

4795 23: 2 wire - 3 way, to article 4791

4795 52: 5 wire - 2 way, to article 4792

4795 53: 5 wire - 3 way, to article 4793

4795 22	-	0,427	1-1	38,44
4795 23	-	0,427	1-1	38,44
4795 52	-	0,529	1-1	46,12
4795 53	-	0,529	1-1	46,12





Ref. 3930K

NEW

Termostato Touch + Receptor Wifi "GE-SMART"

El kit consta del termostato de calefacción touch art. 3930 i el receptor WIFI art. 3932.

Touch Thermostat + Wifi Gateway "GE-SMART"

Kit with touch thermostat art. 3930 and WIFI gateway art. 3932.



CÓDIGO CODE	MEDIDA SIZE	PESO WEIGHT	CAJA / BOX CARTON	P.V.P. € PRICE €
3930K	-	0,368	1-22	168,16

Ref. 3931K

NEW

Cabezal Termostático + Receptor Wifi "GE-SMART"

El kit consta del cabezal termostatico art. 3931 i el receptor WIFI art. 3932.

Thermostatic head + "GE-SMART" WIFI Gateway

Kit with thermostatic head art. 3931 and WIFI gateway art. 3932.



3931K	-	0,315	1-25	150,68
-------	---	-------	------	--------

Ref. 3932

NEW

Receptor Wifi "GE-SMART"

Alimentación: Micro USB 5V (1A) mediante cable adaptador de red 230VAC. Conectividad WIFI. IP30. Temperatura ambiente: 5-50°C. Receptor WIFI conectado a 2,4 GHz. Dimensiones: 78 x 98 x 28 mm.

"GE-SMART" WIFI gateway

Power supply micro USB 5V (1A) conection via 230V adapter. WIFI connectivity. IP30, Ambient temperature range: 5-50°C. WIFI gateway connected 2,4 GHz. Dimensions: 78 x 98 x 28 mm.



3932 00	-	0,150	1-45	85,17
---------	---	-------	------	-------

Ref. 3930

NEW

Termostato Touch "GE-SMART"

Alimentación: 2 baterías 1,5V, tipo AA o con cable micro USB 5V (1A). Conectividad WIFI. Rango de contacto 250VAC-0,25A. IP30. Rango temperatura regulación: 5-35°C. Diferencial termico ± 0,5 °C . Pantalla LCD táctil retro iluminada. Programable. Dimensiones: 125 x 98 x 23,5 mm.

"GE-SMART" touch thermostat

Power supply 2 batteries 1,5V. AA type or micro USB 5V (1A). WIFI connectivity. Relay contact range 250VAC-0,25A. IP30. Setting temperature range: 5-35°C. Diferential: ± 0,5 °C . Touch LCD backlight screen. Programmable. Dimensions: 125 x 98 x 23,5 mm.



3930 00	-	0,185	1-48	80,80
---------	---	-------	------	-------

CÓDIGO CODE	MEDIDA SIZE	PESO WEIGHT	CAJA / BOX CARTON	P.V.P. € PRICE €
-------------	-------------	-------------	-------------------	------------------

Ref. 3931

NEW

Cabezal termostático "GE-SMART"

Alimentación: 2 baterías 1,5V, tipo AA. Conectividad WIFI. IP20. Rango temperatura de regulación: 5-35°C. Diferencial termico $\pm 0,5$ °C . Pantalla LCD retro iluminada. Programable. Dimensiones: $\varnothing 55 \times 83$ mm.



"GE-SMART" thermostatic head

Power supply 2 batteries 1,5V. AA. WIFI connectivity. IP20. Setting temperature range: 5-35°C. Differential: $\pm 0,5$ °C . LCD backlight display. Programmable. Dimensions: $\varnothing 55 \times 83$ mm.

3931 00 - 0,140 1-42 65,52

Ref. 3917

NEW

Termostato Digital Frío - Calor

Alimentación: 2 baterías 1,5V, tipo AAA. Rango de contacto 250VAC-0,25A. IP30. Rango temperatura regulación: 5-35°C. Diferencial termico $\pm 0,5$ °C . Elemento sensible termistor NTC 10K. Pantalla LCD retro iluminada. Programable.



Heat - Cool Digital Thermostat

Power supply 2 batteries 1,5V. AAA type. Relay contact range 250VAC-0,25A. IP30. Setting temperature range: 5-35°C. Differential: $\pm 0,5$ °C . Sensing element NTC 10K thermistor. LCD backlight display. Programmable.

3917 00 - 0,165 1-48 41,49

Ref. 3911

Termostato de pared electromecánico

Alimentación: 2 hilos a 250 VAC. IP 20. Diferencial térmico ± 1 °C; Rango temperatura regulación: +7 / +30°C; Dimensiones 80x80x44 mm.



Wall electromechanical thermostat

Power supply: 2 wire to 259 VAC. IP 20. Differential ± 1 °C; Setting temperature range +7 / +30°C; Dimensions 80x80x44 mm.

3911 00 - 0,152 1-20 12,30

Ref. 3912

Termostato de pared electrónico

Alimentación: 2 baterías 1,5 V, tipo AAA. Rango temperatura de regulación: 5°C -35°C. Diferencial térmico: $\pm 0,3$ °C.



Wall mounted electronic thermostat

Power supply: 2 batteries 1,5 V, AAA type. Setting temperature range: 5°C-35°C. Differential: $\pm 0,3$ °C.

3912 00 - 0,170 1-68 57,92



Ref. 3916



Termostato de pared electrónico frío - calor

Alimentación: 2 baterías 1,5V, tipo AAA. Rango de contacto 5A, 220VAC. IP20. Rango temperatura regulación: 5-35°C. Diferencial térmico $\pm 0,5$ °C. Resolución 0,1°C. Elemento sensible termistor NTC. Pantalla LCD retro iluminada. No programable.

Heat - Cool wall mounted electronic thermostat

Power supply: 2 batteries 1,5V, AAA type. Contact range 5A, 220VAC. IP20. Setting temperature range 5-35°C. Differential $\pm 0,5$ °C. Resolución 0,1°C. Sensing element NTC thermistor. LCD backlight display. Non programmable.

CÓDIGO CODE	MEDIDA SIZE	PESO WEIGHT	CAJA / BOX CARTON	P.V.P. € PRICE €
3916 00	-	0,138	50	38,24

Ref. 3915



Termostato contacto bimetalico

Termostato contacto bimetalico. Alimentación: a 250 VAC. IP 20. Diferencial térmico 8 ± 2 K. Rango temperatura regulación: 20/90°C.

Bimetalic contact thermostat

Dimensions 112x46x55 mm. Power supply: 250 VAC. IP 20. Temperature diferencial 8 ± 2 K; Setting temperature range 20/90°C.

3915 00	-	0,110	1-50	15,14
---------	---	-------	------	-------

Ref. 8045 - 8046



Termómetro de capilla

Salida inferior, vaina latón. Longitud = 50 mm. Rosca G 1/2".

Glass thermometers

Bottom entry, brass sheath. Length = 50 mm. G 1/2" thread.

8045 404	-40 +40 °C	0,167	1-1	35,06
8045 060	0 +60 °C	0,167	1-1	35,06
8045 120	0 +120 °C	0,167	1-1	35,06

Termómetro de capilla

Salida inferior, vaina latón. Longitud = 100 mm. Rosca G 1/2".

Glass thermometers

Bottom entry, brass sheath. Length = 100 mm. G 1/2" thread.

8046 404	-40 +40 °C	0,2	1-1	46,76
8046 060	0 +60 °C	0,2	1-1	46,76
8046 120	0 +120 °C	0,2	1-1	46,76

Ref. 8047 - 8048



Termómetro de capilla

Salida angular 90°, vaina latón. Longitud = 50 mm. Rosca G 1/2".

Glass thermometers

90° angle entry, brass sheath. Length = 50 mm. G 1/2" thread.

8047 404	-40 +40 °C	0,17	1-1	37,20
8047 060	0 +60 °C	0,17	1-1	37,20
8047 120	0 +120 °C	0,17	1-1	37,20

Termómetro de capilla

Salida angular 90°, vaina latón. Longitud = 100 mm. Rosca G 1/2".

Glass thermometers

90° angle entry, brass sheath. Length = 100 mm. G 1/2" thread.

8048 404	-40 +40 °C	0,202	1-1	48,88
8048 060	0 +60 °C	0,202	1-1	48,88
8048 120	0 +120 °C	0,202	1-1	48,88

CÓDIGO CODE	MEDIDA SIZE	PESO WEIGHT	CAJA / BOX CARTON	P.V.P. € PRICE €
----------------	----------------	----------------	----------------------	---------------------

Ref. **73262**



Bomba descarga condensados

Unidad de pared para evacuar los condensados generados por unidades de climatización de arira acondicionado de hasta 13 KW. Caudal maximo 10 l/h. Temperatura maxima agua drenaje 40°C. Tensión de alimentación 230V AC 50-60Hz 16W. Homologación CE

Condensate removal pump

Wall pump unit for condensate removal in air conditioning up to 13 KW. Maximum flow rate 10 l/h. Max. discharge water temperature 40°C. Electrical power 230V AC 50-60Hz. CE marked.

73262 00 00	10 L	0,450	25	86,59
-------------	------	-------	----	--------------

Ref. **3262**



Bomba para calderas de condensacion

Sistema compuesto de una unidad de bomba y una unidad de detección para evacuar los condensados en unidades de aire acondicionado y de refrigeración. Voltaje 230V 50/60 Hz. Instalación interna o externa. Caudal entre 4 y 7 L/h. Máxima temperatura del condensado 40°C.

Mini Condensate pump

It is a system which consists of a pump unit and detection unit allowing condensates to be evacuated in air conditioning and refrigeration. Voltage 230V 50/60 Hz. Internal or external installation. Flow rate between 4 and 7 L/h. Máx. Temperature of condensate 40°C.

3262 00	-	-	1-24	94,11
---------	---	---	------	--------------

Ref. **3263**



Bomba para calderas de condensación

Sistema compuesto de una unidad de bomba y una unidad de detección para evacuar los condensados en calderas, unidades de aire acondicionado y de refrigeración. Voltaje 230V 50 Hz. Instalación externa. Caudal máximo 370 L/h. Máxima temperatura del condensado 50°C.

Condensate pump

It is a system which consists of a pump unit and detection unit allowing condensates to be evacuated in boiler, air conditioning and refrigeration. Voltage 230V 50 Hz. Internal or external installation. Flow rate max.370 L/h. Máx. Temperature of condensate 50°C.

3263 00	-	2,3	1-4	116,70
---------	---	-----	-----	---------------

Ref. **70500**



Mando universal aire acondicionado

A/C universal remote control

70500	-	-	1-100	14,58
-------	---	---	-------	--------------

CALEFACCIÓN Y ENERGÍA SOLAR HEATING & SOLAR ENERGY

ENERGÍA SOLAR TÉRMICA THERMAL SOLAR ENERGY

La “energía solar térmica” es una tecnología que convierte la luz solar en calor que puede después ser usado para calentar agua para uso doméstico y para el sistema de calefacción.

Existen diferentes tipos de sistemas solares empleados para el calentamiento de agua sanitaria y/o la propia calefacción, entre los cuales destacan por ser los más utilizados los sistemas de circulación natural, los sistemas de circulación forzada y los sistemas combinados.

Para todos los tipos existentes se requiere de una serie de elementos para su instalación, de los cuales Genebre pone a su disposición una amplia gama de ellos, que se irá ampliando según las necesidades de nuestros clientes e instaladores.

“Thermal solar energy” is a technology that converts sunlight into heat that can then be used to heat domestic water and heating system.

There are different types of solar systems used only for the heating of water for human consumption and/or for the heating system, forced circulation systems and combined systems being among those which stand out as being the most widely used natural circulation systems.

For all existing types a series of elements are required for their installation. Genebre offers a wide range of them, to be expanded according to the needs of our customers and installers.

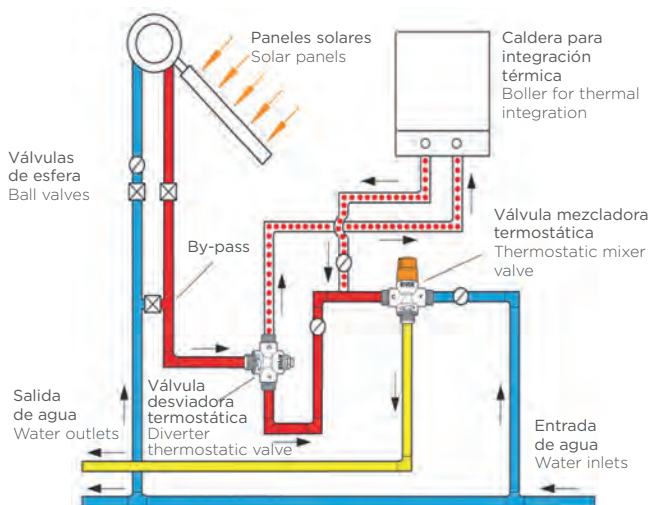
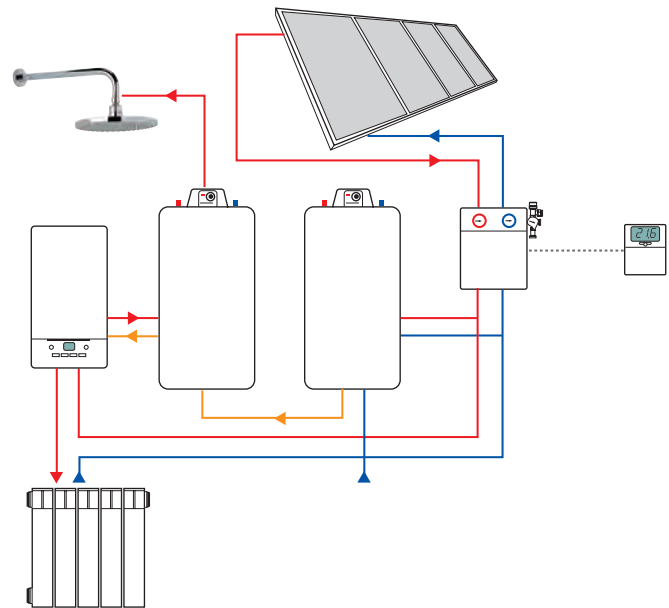

Instalación básica
Basic installation

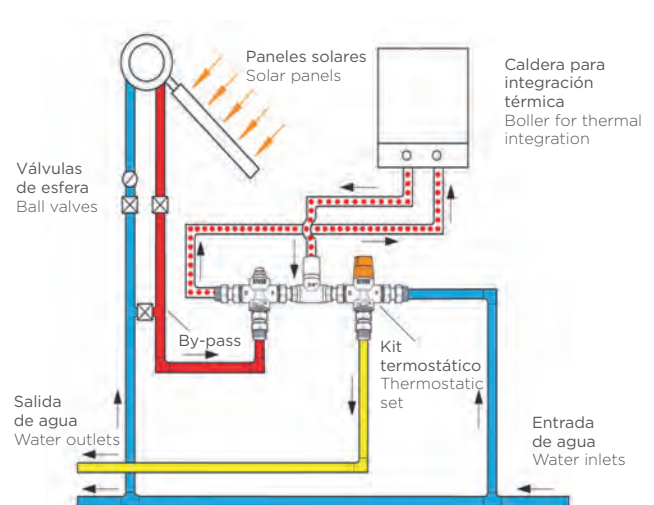

Esquema kit termostático
Thermostatic kit installation

Ref. 3134



Válvula de esfera

PN 25. Paso total. Construcción en latón UNE-EN 12165 cromado. Juntas PTFE. Extremos rosca gas M-H, ISO 228/1. Temp. máx. 150°C. Mando manual por palanca acero.

Ball valve

PN 25. Full bore. Body chrome plated brass UNE-EN 12165. Seats PTFE. Gas threaded ends M-F, ISO 228/1. Max. temp. 150°C. Manual control lever steel handle.

R	P	A	L	M
1/2"	15	47	55	84
3/4"	20	58	64	98
1"	25	61	76	98
1 1/4"	32	74	87	126
1 1/2"	40	80	95	126
2"	50	91	109	158

CÓDIGO CODE	MEDIDA SIZE	PESO WEIGHT	CAJA / BOX CARTON	P.V.P. € PRICE €
3134 04	1/2"	0,160	8-152	4,98
3134 05	3/4"	0,270	6-108	8,24
3134 06	1"	0,410	6-72	12,23
3134 07	1 1/4"	0,650	4-34	19,10
3134 08	1 1/2"	0,875	2-24	27,80
3134 09	2"	1,370	2-18	42,02

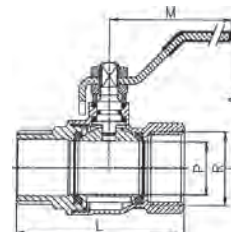

Ref. 3136



Válvula de esfera

PN 25. Paso total. Construcción en latón UNE-EN 12165 cromado. Juntas PTFE. Extremos rosca gas M-H, ISO 228/1. Temp. máx. 150°C. Mando manual por palomilla aluminio.

Ball valve

PN 25. Full bore. Body chrome plated brass UNE-EN 12165. Seats PTFE. Gas threaded ends M-F, ISO 228/1. Max. temp. 150°C. Manual control lever aluminium handle.

R	P	A	L	M
3/8"	10	38	49	50
1/2"	15	40	56	50
3/4"	20	50	64	62
1"	25	53	76	62

3136 03	3/8"	0,105	12-288	4,11
3136 04	1/2"	0,145	10-240	5,07
3136 05	3/4"	0,240	6-108	8,14
3136 06	1"	0,364	5-90	12,32

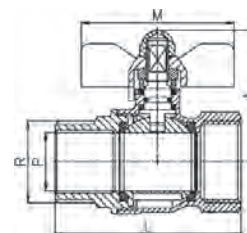

Ref. 70037



Purgador automático de aire

Cuerpo en latón niquelado. Extremo rosca macho ISO 228/1. Temperatura máxima de trabajo 160°C. Presión máxima de trabajo: 10 bar.

Automatic air vent

Body brass nickel-plated. Male thread ISO 228/1. Maximum working temperature 160°C. Maximum working pressure: 10 bar.

R	A	D	H
G 3/8"	79	50	64

70037 03 00	3/8"	0,224	10-80	9,81
-------------	------	-------	-------	-------------

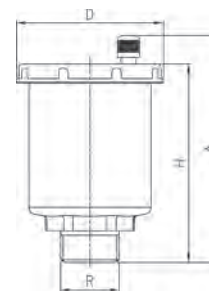

Ref. 3178



Válvula de seguridad escuadra

Cuerpo en latón. Extremos rosca hembra ISO 228/1. Temperatura máxima de trabajo 160°C. Taraje 6 bar.

Safety angle valve

Body in brass. Female threaded ends ISO 228/1. Maximum working temperature 160°C. 6 bar setting pressure.

H	A
76	31

3178 04	1/2" x 3/4"	0,116	10-100	15,39
---------	-------------	-------	--------	--------------

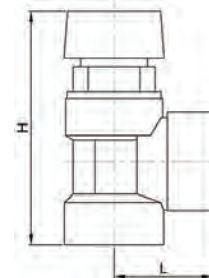

Ref. 2444



Válvula retención "Small" - "Idrja" para solar

Construcción: AISI 304 - asiento vitón. Extremos roscados DIN 2999. Temp. de trabajo, mín. -25°C máx. +150°C. Presión de trabajo, 16 bar. Presión de apertura, 0,03 bar.

"Small" check valve "Idrja" for solar energy

Constr.: AISI 304 - viton seat. Gas threaded ends DIN 2999. Working temp. min. -25°C +150°C. Working pressure: 16 bar. Opening pressure: 0.03 bar.

DN	R	B	C
15	1/2"	32	55
20	3/4"	44	66,7
25	1"	53	83
32	1 1/4"	62	97

CÓDIGO CODE	MEDIDA SIZE	PESO WEIGHT	CAJA / BOX CARTON	P.V.P. € PRICE €
2444 04	1/2"	0,093	12-288	22,57
2444 05	3/4"	0,138	8-104	27,37
2444 06	1"	0,600	8-80	31,99
2444 07	1 1/4"	0,001	6-48	41,92

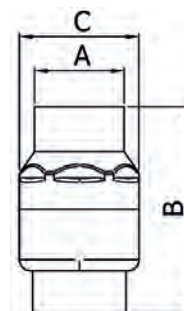

Ref. 1431S



Mezclador termostático vertical para paneles solares

Volante de regulación de temperatura de 30°C a 65°C. Temperatura máxima de entrada de agua 100°C. Aplicación para paneles solares.

Vertical thermostatic mixing valve for solar installation

Temperature adjusting handle from 30°C to 65°C. Maximum temperature inlet 100°C. For solar panels application.

R	A	B	C	Ø D
3/4"	58	93	42	36,5

1431S 05	3/4"	0,340	1-48	73,16
----------	------	-------	------	-------

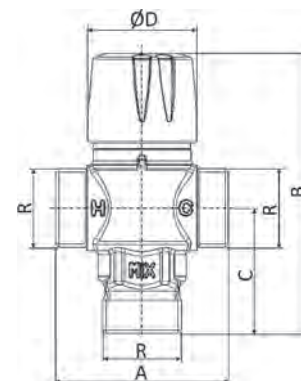

Ref. 1431U



Mezclador termostático vertical universal

Dispositivo para regular temperatura con bloqueo del suministro según EN 1111. Cartucho extraíble y unidad termostática especial con protección anticál y alta velocidad de respuesta. Posibilidad de bloqueo del volante tras la regulación. Temperatura máxima de entrada agua 110°C y posibilidad de regulación de 25°C a 65°C. Aplicación en todos los sistemas sanitarios.

Universal vertical thermostatic mixing valve

Anti-scalding device with stop water supply EN 1111. Extractable cartridge and thermostatic special unit with lime protection and high-speed response. Possibility to block the handle position after the adjusting of the temperature. Maximum temperature inlet 110°C and possibility of adjustment from 25°C to 65°C. For all of the sanitary systems application.

a	b
63	42

1431U	3/4"	0,396	1	80,32
-------	------	-------	---	-------

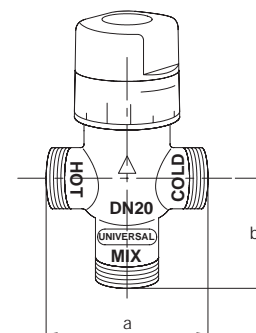

Ref. 1444



Mezclador termostático vertical con termómetro

Dispositivo para regular temperatura con bloqueo del suministro según EN 1111. Cartucho extraíble y unidad termostática especial con protección antical y alta velocidad de respuesta. Posibilidad de bloqueo del volante tras la regulación. Temperatura máxima de entrada agua 110°C. Termómetro de inmersión incorporado. Con filtro de acero inoxidable, válvula de retención y rácores incorporados. Aplicación para paneles solares.

Vertical thermostatic mixing valve with thermometer

Anti-scalding device with stop water supply S/EN 1111. Extractable cartridge and thermostatic special unit with lime protection and high-speed response. Possibility to block the handle position after the adjusting of the temperature. Maximum temperature inlet 110°C. Immersion thermometer incorporated. With stainless steel filter, check valve and tangs incorporated. For solar panels application.

Medida/ Size	a	b
3/4"	165	120
1/2"	147	120

CÓDIGO CODE	MEDIDA SIZE	PESO WEIGHT	CAJA / BOX CARTON	P.V.P. € PRICE €
-------------	-------------	-------------	-------------------	------------------

1444 04	1/2"	1,070	1	175,96
1444 05	3/4"	1,175	1	175,96

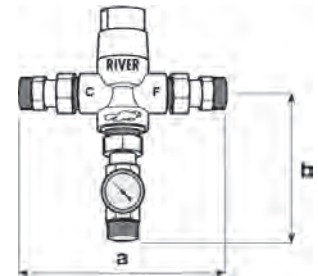

Ref. 1452



Válvula desviadora termostática

Desvía automáticamente el agua caliente que proviene del panel a la caldera, sólo cuando es necesario integrar la temperatura. Elemento termostático con protección antical y alta velocidad de respuesta. Temperatura máxima de entrada agua 110°C. Válvula tarada a 40°C.

Divert thermostatic valve

Divert automatically the hot water coming from the panel to the boiler only when it is necessary integrate the temperature. Thermostatic unit with lime protection and high-speed response. Maximum temperature inlet 110°C. Setting temperature 40°C.

a	b
90	44

1452 05	3/4"	0,645	1	104,39
---------	------	-------	---	--------

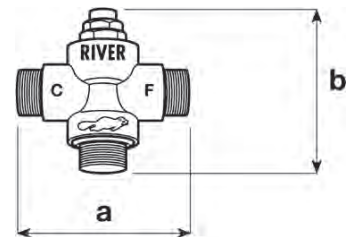

Ref. 1451



Kit termostático con válvula desviadora y mezclador

Kit termostático premontado antiescaldado para facilitar la conexión desde el panel solar hasta la caldera y una válvula desviadora termostática. Mezclador con temperatura máxima de entrada 110°C, filtro de inoxidable, válvula de retención y rácores. Válvula desviadora termostática con temperatura preestablecida de 40°C.

Thermostatic kit with divert valve and mixer

Anti-scalding connected thermostatic kit for facilitate connection from the solar panel to the boiler. Mainly composed of a vertical thermostatic mixer and a divert thermostatic valve. Mixer with stainless steel filter, check valve and tangs with maximum water inlet temperature 110°C. Divert thermostatic valve with setting temperature 40°C.

a	b	c
198	360	180

1451 05	3/4"	2,275	1	313,66
---------	------	-------	---	--------

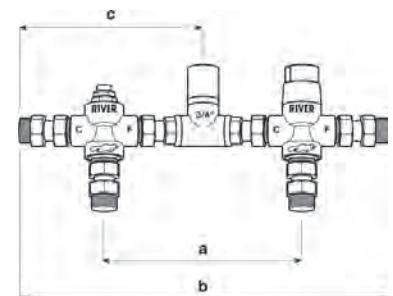

GENEBRE



VÁLVULAS DE GAS

GAS VALVES



Válvulas de gas con certificación AENOR para el mercado español, diseñadas según normas UNE-EN 331 y UNE 60718. Y otras válvulas de gas para mercados internacionales.

Gas valves with AENOR certification for the Spanish market, designed according to UNE-EN 331 and UNE 60718 standards, as well as other gas valves for the International markets.

VÁLVULAS DE GAS GAS VALVES

Las válvulas de gas de Genebre están diseñadas según normas UNE- EN 331 y UNE 60718.

Estas válvulas están destinadas a instalaciones domésticas y comerciales que no se encuentran enterradas directamente en el interior o exterior de edificios, y que emplean gases de la primera, segunda y tercera familia, según la norma en 437.

Genebre's gas valves are designed according to UNE-EN 331 and UNE 60718 standards.

They are used for domestic and commercial installations not buried deep inside or outside of buildings, and which use first, second and third family gases, according to en 437 standards.



1. Cuerpo Body
2. Asientos Ball seats
3. Esfera Ball
4. Junta tórica O'ring
5. Tapa Cap
6. Eje Stem
7. Junta tórica O'ring
8. Tuerca Nut
9. Accionamiento Handle



CARACTERÍSTICAS DE LAS VÁLVULAS

- Construcción en latón UNE-EN 12164-12165
- Juntas en NBR según EN 549
- Extremos roscados gas (BSP) según ISO 228/1
- Eje con doble junta tórica
- Accionamientos precintables
- Sellado de cuerpo y tapa mediante adhesivo y junta tórica
- Temperatura de servicio desde -40°C a 60°C
- Sistema de bloqueo en posición de cierre
- Presión de trabajo 5 bar (MOP 5)
- Garantizada para el uso de Gas Natural

VALVES CHARACTERISTICS

- Brass construction UNE-EN 12164-12165
- NBR joint following EN 549
- Gas (BSP) threaded ends according ISO 228/1
- Stem with double o'ring
- Sealeable handles
- Body and cap sealed by means adhesive and o-ring
- Service temperature from -40°C to 60°C
- Locking system at closed position
- Working pressure 5 bar (MOP 5)
- Guaranteed for the use of Natural Gas

Ref. 3610



Válvula esfera recta para gas, M-M

Construcción en latón según UNE-EN 12165. Asientos PTFE. Clase MOP 5 (0 a 5 bar). Juntas de NBR. Extremos roscados según ISO 228/1 M-M. Rango de temperatura -20°C a 60°C. Mando palanca de acero con recubrimiento DACROMET, precintable. Certificada por AENOR según norma UNE-EN 331 y UNE 60718.

Ball straight valve for gas, M-M

Body brass UNE-EN 12165. PTFE seats. MOP 5 class (0 to 5 bar). NBR joints. Threaded ends according to ISO 228/1 M-M. Temperature range -20°C to 60°C. DACROMET covering steel lever handle, sealable. Certified by AENOR according to standard UNE-EN 331 and UNE 60718.

R	P	L	A	M	t
1/2"	10	56	46	84	10
3/4"	15	65	48	84	13
1"	20	75	58	98	15
1 1/4"	25	87	62	98	19
1 1/2"	32	101	74	125	21
2"	40	124	80	125	27

CÓDIGO CODE	MEDIDA SIZE	PESO WEIGHT	CAJA / BOX CARTON	P.V.P. € PRICE €
----------------	----------------	----------------	----------------------	---------------------

3610 04	1/2"	0,154	8-144	5,62
3610 05	3/4"	0,220	8-144	8,11
3610 06	1"	0,365	6-72	13,05
3610 07	1 1/4"	0,575	4-48	19,78
3610 08	1 1/2"	0,825	2-24	30,81
3610 09	2"	1,380	2-24	49,28

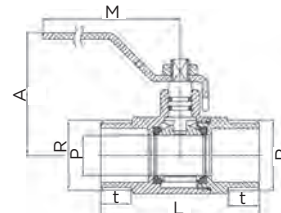

Ref. 3615



Válvula esfera recta para gas, M-M

Construcción en latón según UNE-EN 12165. Asientos PTFE. Clase MOP 5 (0 a 5 bar). Juntas de NBR. Extremos roscados según ISO 228/1 M-M. Rango de temperatura -20°C a 60°C. Mando palomilla de aluminio pintada, precintable. Certificada por AENOR según norma UNE-EN 331 y UNE 60718.

Ball straight valve for gas, M-M

Body brass UNE-EN 12165. PTFE seats. MOP 5 class (0 to 5 bar). NBR joints. Threaded ends according to ISO 228/1 M-M. Temperature range -20°C to 60°C. Painted aluminum butterfly handle, sealable. Certified by AENOR according to standard UNE-EN 331 and UNE 60718.

R	P	L	A	M	t
1/2"	10	56	35	50	10
3/4"	15	65	37	50	13
1"	20	75	45	62	15
1 1/4"	25	87	49	62	19

3615 04	1/2"	0,140	10-180	5,14
3615 05	3/4"	0,200	6-108	7,83
3615 06	1"	0,330	5-90	12,22
3615 07	1 1/4"	0,545	4-48	20,10

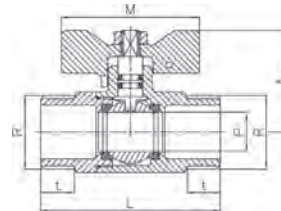

Ref. 3620



Válvula esfera recta para gas, M-H tuerca deslizante

Construcción en latón según UNE-EN 12165. Asientos PTFE. Clase MOP 5 (0 a 5 bar). Juntas de NBR. Extremos roscados según ISO 228/1 M-H tuerca deslizante. Rango de temperatura -20°C a 60°C. Mando palanca de acero con recubrimiento DACROMET, precintable. Certificada por AENOR según norma UNE-EN 331 y UNE 60718.

Ball straight valve for gas, M-F sliding nut

Body brass UNE-EN 12165. PTFE seats. MOP 5 class (0 to 5 bar). NBR joints. Threaded ends according to ISO 228/1 M-F sliding nut. Temperature range -20°C to 60°C. DACROMET covering steel lever handle, sealable. Certified by AENOR according to standard UNE-EN 331 and UNE 60718.

R	P	L	A	M	t
3/4"	15	70	48	84	13
7/8"	20	75	58	98	15
1 1/4"	25	100	62	98	19

3620 05	3/4"	0,255	6-108	9,89
3620 78	7/8"	0,405	6-72	15,23
3620 07	1 1/4"	0,670	2-24	23,85

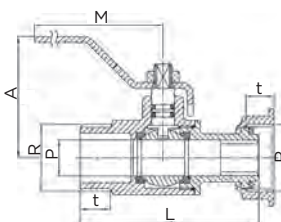

Ref. 3622



Válvula esfera recta para gas, M-H tuerca deslizante

Construcción en latón según UNE-EN 12165. Asientos PTFE. Clase MOP 5 (0 a 5 bar). Juntas de NBR. Extremos roscados según ISO 228/1 M-H tuerca deslizante. Rango de temperatura -20°C a 60°C. Mando palomilla de aluminio pintada, precintable. Certificada por AENOR según norma UNE-EN 331 y UNE 60718.

Ball straight valve for gas, M-F sliding nut

Body brass UNE-EN 12165. PTFE seats. MOP 5 class (0 to 5 bar). NBR joints. Threaded ends according to ISO 228/1 M-F sliding nut. Temperature range -20°C to 60°C. Painted aluminum butterfly handle, sealable. Certified by AENOR according to standard UNE-EN 331 and UNE 60718.

R	P	L	A	M	t
3/4"	15	70	37	50	13
7/8"	20	75	45	62	15
1 1/4"	25	100	49	62	19

3622 05	3/4"	0,235	5-90	9,34
3622 78	7/8"	0,385	5-90	14,55
3622 07	1 1/4"	0,650	4-48	23,53

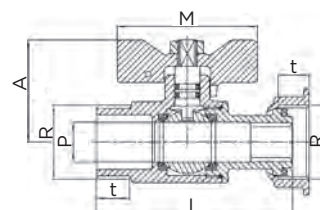

Ref. 3625



Válvula esfera esquadra para gas, M-H tuerca deslizante

Construcción en latón según UNE-EN 12165. Asientos PTFE. Clase MOP 5 (0 a 5 bar). Juntas de NBR. Extremos roscados según ISO 228/1 M-H tuerca deslizante. Rango de temperatura -20°C a 60°C. Mando palanca de acero con recubrimiento DACROMET, precintable. Certificada por AENOR según norma UNE-EN 331 y UNE 60718.

Ball angle valve for gas, M-F sliding nut

Body brass UNE-EN 12165. PTFE seats. MOP 5 class (0 to 5 bar). NBR joints. Threaded ends according to ISO 228/1 M-F sliding nut. Temperature range -20°C to 60°C. DACROMET covering steel lever handle, sealable. Certified by AENOR according to standard UNE-EN 331 and UNE 60718.

R	P	L	A	M	t
3/4"	15	38	48	84	12
7/8"	20	39	58	98	12
1 1/4"	25	59	62	98	16

CÓDIGO CODE	MEDIDA SIZE	PESO WEIGHT	CAJA / BOX CARTON	P.V.P. € PRICE €
----------------	----------------	----------------	----------------------	---------------------

3625 05	3/4"	0,235	6-108	9,09
3625 78	7/8"	0,375	6-72	14,39
3625 07	1 1/4"	0,640	2-48	26,22

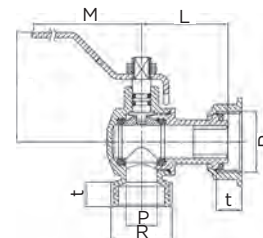

Ref. 3627



Válvula esfera esquadra para gas, M-H tuerca deslizante

Construcción en latón según UNE-EN 12165. Asientos PTFE. Clase MOP 5 (0 a 5 bar). Juntas de NBR. Extremos roscados según ISO 228/1 M-H tuerca deslizante. Rango de temperatura -20°C a 60°C. Mando palomilla de aluminio pintada, precintable. Certificada por AENOR según norma UNE-EN 331 y UNE 60718.

Ball angle valve for gas, M-F sliding nut

Body brass UNE-EN 12165. PTFE seats. MOP 5 class (0 to 5 bar). NBR joints. Threaded ends according to ISO 228/1 M-F sliding nut. Temperature range -20°C to 60°C. Painted aluminum butterfly handle, sealable. Certified by AENOR according to standard UNE-EN 331 and UNE 60718.

R	P	L	A	M	t
3/4"	15	70	37	50	13
7/8"	20	75	45	62	15
1 1/4"	25	100	49	62	19

3627 05	3/4"	0,215	5-90	8,59
3627 78	7/8"	0,355	5-90	13,53
3627 07	1 1/4"	0,620	4-48	25,72

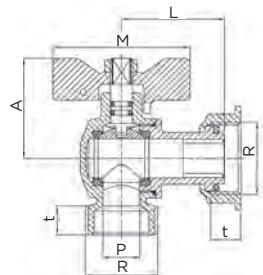

Ref. 3630



Válvula esfera recta para gas con patas, M-M

Construcción en latón según UNE-EN 12165. Asientos PTFE. Clase MOP 5 (0 a 5 bar). Juntas de NBR. Extremos roscados según ISO 228/1 M-M. Rango de temperatura -20°C a 60°C. Mando palanca de acero con recubrimiento DACROMET, precintable. Certificada por AENOR según norma UNE-EN 331 y UNE 60718.

Ball straight valve for gas with feet, M-M

Body brass UNE-EN 12165. PTFE seats. MOP 5 class (0 to 5 bar). NBR joints. Threaded ends according to ISO 228/1 M-M. Temperature range -20°C to 60°C. DACROMET covering steel lever handle, sealable. Certified by AENOR according to standard UNE-EN 331 and UNE 60718.

R	P	L	A	M	t
1/2"	10	56	46	84	10
3/4"	15	65	48	84	13

3630 04	1/2"	0,188	8-144	6,72
3630 05	3/4"	0,258	8-96	9,69

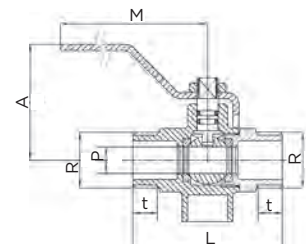

Ref. 3632



Válvula esfera recta para gas con patas, M-M

Construcción en latón según UNE-EN 12165. Asientos PTFE. Clase MOP 5 (0 a 5 bar). Juntas de NBR. Extremos roscados según ISO 228/1 M-M. Rango de temperatura -20°C a 60°C. Mando palomilla de aluminio pintada, precintable. Certificada por AENOR según norma UNE-EN 331 y UNE 60718.

Ball straight valve for gas with feet, M-M

Body brass UNE-EN 12165. PTFE seats. MOP 5 class (0 to 5 bar). NBR joints. Threaded ends according to ISO 228/1 M-M. Temperature range -20°C to 60°C. Painted aluminum butterfly handle, sealable. Certified by AENOR according to standard UNE-EN 331 and UNE 60718.

R	P	L	A	M	t
1/2"	10	56	35	50	10
3/4"	15	65	37	50	13

3632 04	1/2"	0,171	10-180	5,94
3632 05	3/4"	0,236	6-108	8,86

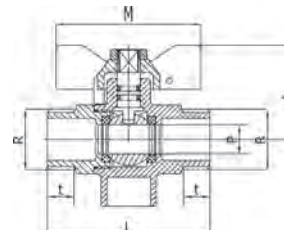

Ref. 3640



Válvula esfera recta para gas con patas, M-conexión tubo PE
 Construcción en latón según UNE-EN 12165. Asientos PTFE. Clase MOP 5 (0 a 5 bar). Juntas de NBR. Extremos roscados según ISO 228/1 M y conexión tubo PE. Rango de temperatura -20°C a 60°C. Mando palomilla de aluminio pintada, precintable. Certificada por AENOR según norma UNE-EN 331 y UNE 60405.

Ball straight valve for gas with feet, M-PE pipe connection
 Body brass UNE-EN 12165. PTFE seats. MOP 5 class (0 to 5 bar). NBR joints. Threaded ends according to ISO 228/1 M and PE pipe connection. Temperature range -20°C to 60°C. Painted aluminum butterfly handle, sealable. Certified by AENOR according to standard UNE-EN 331 and UNE 60405.

R	r	P	A	B	L	M	t
G3/4"	Rp 1/4"	15	42	20	104	48	13
G3/4"	Rp 1/4"	15	42	32	111	48	13

CÓDIGO CODE	MEDIDA SIZE	PESO WEIGHT	CAJA / BOX CARTON	P.V.P. € PRICE €
----------------	----------------	----------------	----------------------	---------------------

3640 05 20	G 3/4" x PE20	0,450	1-36	24,41
3640 05 32	G3/4" x PE32	0,630	1-36	31,16

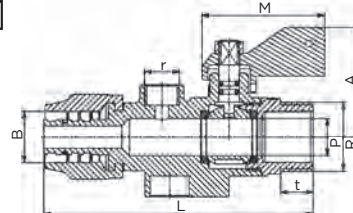

Ref. 3600



Válvula esfera recta para gas con autobloqueo, M-M

Construcción en latón según UNE-EN 12165 cromado. Asientos PTFE. Clase MOP 5 (0 a 5 bar). Juntas de NBR. Extremos roscados según ISO 228/1 o rosca métrica M20 x 1,5 M-M. Rango de temperatura -20°C a 60°C. Mando precintable de Zamak cromado, accionamiento con muelle de seguridad. Certificada por AENOR según norma UNE-EN 331 y UNE 60718.

Ball straight valve for gas with autoblock, M-M
 Chrome plated body brass UNE-EN 12165. PTFE seats. MOP 5 class (0 to 5 bar). NBR joints. Threaded ends according to ISO 228/1 or metric M20 x 1,5 M-M. Temperature range -20°C to 60°C. Chrome plated zamak sealable handle, manual control with safety spring. Certified by AENOR according to standard UNE-EN 331 and UNE 60718.

R	P	L	A	M
1/2"	9	55	32	51
M20 x 1,5	9	55	32	51
3/4"	14	65	38	51

3600 04	1/2"	0,155	1-192	8,14
3600 20	M20 x 1,5	0,162	1-192	8,38
3600 05	3/4"	0,236	1-100	13,56

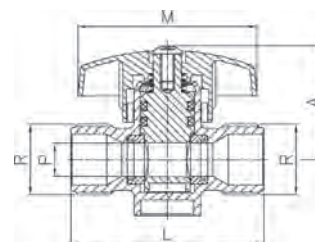

Ref. 3692



Válvula recta para gas con autobloqueo y limitador de caudal, M-M

Construcción en latón según UNE-EN 12165 cromado. Asientos PTFE. Clase MOP 5 (0 a 5 bar). Juntas de NBR. Extremos roscados según ISO 228/1 M-M. Rango de temperatura -20°C a 60°C. Mando precintable de Zamak cromado, accionamiento con muelle de seguridad. Certificada por AENOR según norma UNE 60718.

Ball straight valve for gas with autoblock and flow limiter, M-M
 Chrome plated body brass UNE-EN 12165. PTFE seats. MOP 5 class (0 to 5 bar). NBR joints. Threaded ends according to ISO 228/1 M-M. Temperature range -20°C to 60°C. Chrome plated zamak sealable handle, manual control with safety spring. Certified by AENOR according to standard UNE 60718.

R	P	L	A	M
1/2"	9	57	34,5	46

3692 04	1/2"	0,190	100	14,35
---------	------	-------	-----	-------

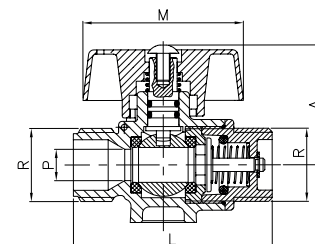

Ref. 3691



Válvula limitadora de cudad externo M-H

Construcción en latón según UNE-EN 12165 cromado. Asientos PTFE.. Extremos roscados según ISO 228/1 M-H. Rango de temperatura -10°C a 40°C. Según norma UNE 60719.

Ball straight valve for gas with autoblock and flow limiter, M-M

Chrome plated body brass UNE-EN 12165. Threaded ends according to ISO 228/1 M-H. Temperature range -10°C to 40°C. According to standard UNE 60719.

3691 04	1/2"	0,052	12-324	6,69
---------	------	-------	--------	------

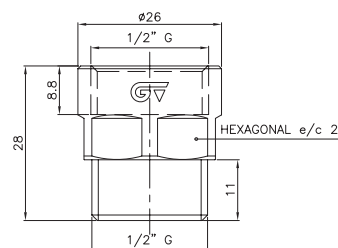

Ref. 3690



Puente de prueba para contador de gas tipo G4

Construcción racor en latón según UNE-EN 12165 cromado. Tubo de cobre. Soldadura estaño-plata. Extremos rosados según ISO 228/1 M-M. Garantizado para el uso con gas natural. Rango de temperatura -20°C a 60°C.

Gas bridge for G4 meters

Fitting brass according to UNE-EN 12165. Pipe in cooper material. Siver-Tin welding. Threaded ends according to ISO 228/1 M-M. Temperature range -20°C to 60°C.

R	L	D
7/8"	160	10

3690 78	7/8"	0,168	1-70	8,32
---------	------	-------	------	------

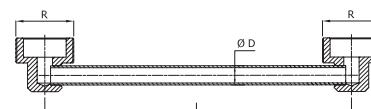

Ref. 3500



Válvula esfera recta para gas, H-H

También disponible con rosca NPT (3500N).
Paso total. Construcción en latón según UNE-EN 12165 cromado. Asientos PTFE. Clase MOP 5 (0 a 5 bar). Juntas de NBR. Extremos roscados según ISO 7/1 H-H. Rango de temperatura -20°C a 60°C. Mando palanca de acero con recubrimiento DACROMET, precintable. Especificaciones según norma UNE-EN 331.

Ball straight valve for gas, F-F

Also available NPT thread (3500N).
Full bore. Chrome plated body brass UNE-EN 12165. PTFE seats. MOP 5 class (0 to 5 bar). NBR joints. Threaded ends according to ISO 7/1 F-F. Temperature range -20°C to 60°C. DACROMET covering steel lever handle, sealable. Requirements according to standard UNE-EN 331.

R	P	L	A	M	t
1/2"	15	58	47	83	15,5
3/4"	20	65	58	97	16,5
1"	25	78	60,5	97	19,5
1 1/4"	32	88	74	125	20

CÓDIGO CODE	MEDIDA SIZE	PESO WEIGHT	CAJA / BOX CARTON	P.V.P. € PRICE €
-------------	-------------	-------------	-------------------	------------------

3500 04	1/2"	0,187	10-180	6,90
3500 05	3/4"	0,305	8-96	10,97
3500 06	1"	0,450	6-72	16,55
3500 07	1 1/4"	0,725	6-36	25,99

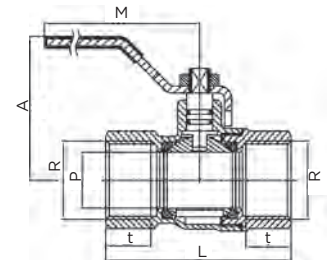

Ref. 3505



Válvula esfera recta para gas, H-H

También disponible con rosca NPT (3505N).
Paso total. Construcción en latón según UNE-EN 12165 cromado. Asientos PTFE. Clase MOP 5 (0 a 5 bar). Juntas de NBR. Extremos roscados según ISO 7/1 H-H. Rango de temperatura -20°C a 60°C. Mando palomilla de aluminio, precintable. Especificaciones según norma UNE-EN 331.

Ball straight valve for gas, F-F

Also available NPT thread (3505N).
Full bore. Chrome plated body brass UNE-EN 12165. PTFE seats. MOP 5 class (0 to 5 bar). NBR joints. Threaded ends according to ISO 7/1 F-F. Temperature range -20°C to 60°C. Aluminum butterfly handle, sealable. Requirements according to standard UNE-EN 331.

R	P	L	A	M	t
1/2"	15	58	35,5	50	15,5
3/4"	20	65	44,5	62	16,5
1"	25	78	47	62	19,5

3505 04	1/2"	0,167	10-180	6,50
3505 05	3/4"	0,273	8-96	10,56
3505 06	1"	0,414	6-72	16,53

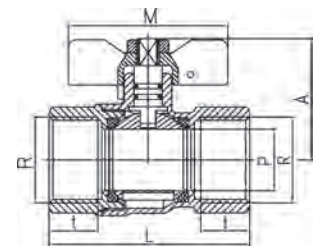

Ref. 3510



Válvula esfera recta para gas, M-H

Paso total. Construcción en latón según UNE-EN 12165 cromado. Asientos PTFE. Clase MOP 5 (0 a 5 bar). Juntas de NBR. Extremos roscados según ISO 7/1 M-H. Rango de temperatura -20°C a 60°C. Mando palanca de acero con recubrimiento DACROMET, precintable. Especificaciones según norma UNE-EN 331.

Ball straight valve for gas, M-F

Full bore. Chrome plated body brass UNE-EN 12165. PTFE seats. MOP 5 class (0 to 5 bar). NBR joints. Threaded ends according to ISO 7/1 M-F. Temperature range -20°C to 60°C. DACROMET covering steel lever handle, sealable. Requirements according to standard UNE-EN 331.

R	P	L	A	M	t	t1
1/2"	15	62,5	47	83	15,5	13,5
3/4"	20	69	58	97	16,5	14,5
1"	25	82,5	60,5	97	19,5	17,5
1 1/4"	32	91,5	74	125	20	19,5

3510 04	1/2"	0,164	10-180	6,95
3510 05	3/4"	0,299	8-96	11,25
3510 06	1"	0,450	6-72	17,57
3510 07	1 1/4"	0,690	6-48	26,65

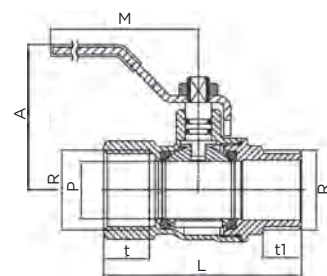

Ref. 3515



Válvula esfera recta para gas, M-H

También disponible con rosca NPT (3515N).
Paso total. Construcción en latón según UNE-EN 12165 cromado. Asientos PTFE. Clase MOP 5 (0 a 5 bar). Juntas de NBR. Extremos roscados según ISO 7/1 M-H. Rango de temperatura -20°C a 60°C. Mando palomilla de aluminio, precintable. Especificaciones según norma UNE-EN 331.

Ball straight valve for gas, M-F

Also available NPT thread (3515N).
Full bore. Chrome plated body brass UNE-EN 12165. PTFE seats. MOP 5 class (0 to 5 bar). NBR joints. Threaded ends according to ISO 7/1 M-F. Temperature range -20°C to 60°C. Aluminum butterfly handle, sealable. Requirements according to standard UNE-EN 331.

R	P	L	A	M	t	t1
1/2"	15	62,5	35,5	50	15,5	13,5
3/4"	20	69	44,5	62	16,5	14,5
1"	25	82,5	47	62	19,5	17,5

3515 04	1/2"	0,163	10-180	6,89
3515 05	3/4"	0,265	8-96	11,53
3515 06	1"	0,413	6-72	17,59

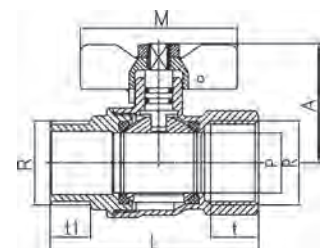

CÓDIGO CODE	MEDIDA SIZE	PESO WEIGHT	CAJA / BOX CARTON	P.V.P. € PRICE €
----------------	----------------	----------------	----------------------	---------------------

Ref. 3520



Válvula esfera recta para gas, H-conexión manguera

Paso total. Construcción en latón según UNE-EN 12165 cromado. Asientos PTFE. Clase MOP 5 (0 a 5 bar). Juntas de NBR. Extremos roscados según ISO 7/1 H y conexión manguera. Rango de temperatura -20°C a 60°C. Mando palomilla de aluminio, precintable. Especificaciones según norma UNE-EN 331.

Ball straight valve for gas, F-hose connection

Full bore. Chrome plated body brass UNE-EN 12165. PTFE seats. MOP 5 class (0 to 5 bar). NBR joints. Threaded ends according to ISO 7/1 F and hose connection. Temperature range -20°C to 60°C. Aluminum butterfly handle, sealable. Requirements according to standard UNE-EN 331.

R	P1	P	L	A	M	t	t1	D
1/2"	6	15	76,5	35,5	50	15,5	29	10,9

3520 04 1/2" 0,163 10-180 6,55

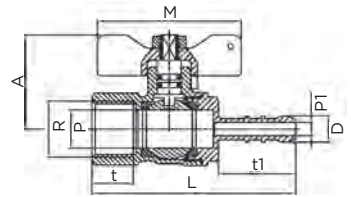

Ref. 3525



Válvula esfera recta para gas, M-conexión manguera

Paso total. Construcción en latón según UNE-EN 12165 cromado. Asientos PTFE. Clase MOP 5 (0 a 5 bar). Juntas de NBR. Extremos roscados según ISO 7/1 M y conexión manguera. Rango de temperatura -20°C a 60°C. Mando palomilla de aluminio, precintable. Especificaciones según norma UNE-EN 331.

Ball straight valve for gas, M-hose connection

Full bore. Chrome plated body brass UNE-EN 12165. PTFE seats. MOP 5 class (0 to 5 bar). NBR joints. Threaded ends according to ISO 7/1 M and hose connection. Temperature range -20°C to 60°C. Aluminum butterfly handle, sealable. Requirements according to standard UNE-EN 331.

R	P1	P	L	A	M	t	t1	D
1/2"	6	15	76,5	35,5	27	14	29	10,9

3525 04 1/2" 0,154 10-180 6,55

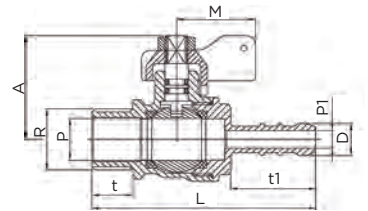

Ref. 3550



Válvula esfera escuadra para gas, M-M

También disponible con rosca NPT (3550N). Paso total. Construcción en latón según UNE-EN 12165 cromado. Asientos PTFE. Clase MOP 5 (0 a 5 bar). Juntas de NBR. Extremos roscados según ISO 7/1 M-M. Rango de temperatura -20°C a 60°C. Mando palomilla de aluminio, precintable. Especificaciones según norma UNE-EN 331.

Angle ball valve for gas, M-M

Also available NPT thread (3550N). Full bore. Chrome plated body brass UNE-EN 12165. PTFE seats. MOP 5 class (0 to 5 bar). NBR joints. Threaded ends according to ISO 7/1 M-M. Temperature range -20°C to 60°C. Aluminum butterfly handle, sealable. Requirements according to standard UNE-EN 331.

R	P	L	A	M	t	t1
1/2"	13,5	46	64,5	27	14	13,5

3550 04 1/2" 0,160 10-180 6,55

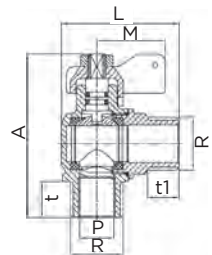

Ref. 3555



Válvula esfera escuadra para gas, M-H

También disponible con rosca NPT (3555N). Paso total. Construcción en latón según UNE-EN 12165 cromado. Asientos PTFE. Clase MOP 5 (0 a 5 bar). Juntas de NBR. Extremos roscados según ISO 7/1 M-H. Rango de temperatura -20°C a 60°C. Mando palomilla de aluminio, precintable. Especificaciones según norma UNE-EN 331.

Angle ball valve for gas, M-F

Also available NPT thread (3555N). Full bore. Chrome plated body brass UNE-EN 12165. PTFE seats. MOP 5 class (0 to 5 bar). NBR joints. Threaded ends according to ISO 7/1 M-F. Temperature range -20°C to 60°C. Aluminum butterfly handle, sealable. Requirements according to standard UNE-EN 331.

R	P	L	A	M	t	t1
1/2"	13,5	43	64,5	27	14	15

3555 04 1/2" 0,162 10-180 6,55

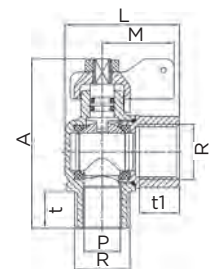

Ref. 3560



Válvula esfera escuadra para gas, M-conexión manguera

También disponible con rosca NPT (3560N). Paso total. Construcción en latón según UNE-EN 12165 cromado. Asientos PTFE. Clase MOP 5 (0 a 5 bar). Juntas de NBR. Extremos roscados según ISO 7/1 M y conexión manguera. Rango de temperatura -20°C a 60°C. Mando palomilla de aluminio, precintable. Especificaciones según norma UNE-EN 331.

Angle ball valve for gas, M-hose connection

Also available NPT thread (3560N). PN25. Full bore. Chrome plated body brass UNE-EN 12165. PTFE seats. MOP 5 class (0 to 5 bar). NBR joints. Threaded ends according to ISO 7/1 M and hose connection. Temperature range -20°C to 60°C. Aluminum butterfly handle, sealable. Requirements according to standard UNE-EN 331.

R	P1	P	L	A	M	t	t1	D
1/2"	6	13,5	61,5	64,5	27	14	29	10,9

3560 04 1/2" 0,162 10-180 6,55

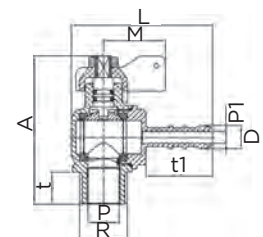

CÓDIGO CODE	MEDIDA SIZE	PESO WEIGHT	CAJA / BOX CARTON	P.V.P. € PRICE €
----------------	----------------	----------------	----------------------	---------------------

Ref. 3565



Válvula esfera esquadra para gas, H-M

También disponible con rosca NPT (3565N).
Paso total. Construcción en latón según UNE-EN 12165 cromado. Asientos PTFE. Clase MOP 5 (0 a 5 bar). Juntas de NBR. Extremos roscados según ISO 7/1 H-M. Rango de temperatura -20°C a 60°C. Mando palomilla de aluminio, precintable. Especificaciones según norma UNE-EN 331.

Angle ball valve for gas, F-M

Also available NPT thread (3565N).
Full bore. Chrome plated body brass UNE-EN 12165. PTFE seats. MOP 5 class (0 to 5 bar). NBR joints. Threaded ends according to ISO 7/1 F-M. Temperature range -20°C to 60°C. Aluminum butterfly handle, sealable. Requirements according to standard UNE-EN 331.

R	P	L	A	M	t	t1
1/2"	13,5	46	64,5	27	15,5	13,5

3565 04	1/2"	0,167	10-180	6,55
---------	------	-------	--------	------

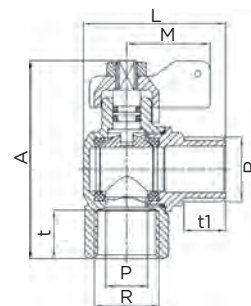

Ref. 3570



Válvula esfera esquadra para gas, H-H

También disponible con rosca NPT (3570N).
Paso total. Construcción en latón según UNE-EN 12165 cromado. Asientos PTFE. Clase MOP 5 (0 a 5 bar). Juntas de NBR. Extremos roscados según ISO 7/1 H-H. Rango de temperatura -20°C a 60°C. Mando palomilla de aluminio, precintable. Especificaciones según norma UNE-EN 331.

Angle ball valve for gas, F-F

Also available NPT thread (3570N).
Full bore. Chrome plated body brass UNE-EN 12165. PTFE seats. MOP 5 class (0 to 5 bar). NBR joints. Threaded ends according to ISO 7/1 F-F. Temperature range -20°C to 60°C. Aluminum butterfly handle, sealable. Requirements according to standard UNE-EN 331.

R	P	L	A	M	t
1/2"	13,5	43	64,5	27	15,5

3570 04	1/2"	0,170	10-180	6,58
---------	------	-------	--------	------

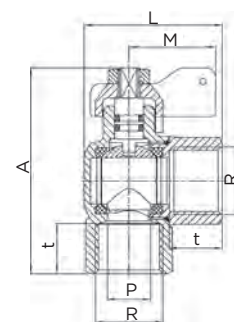

Ref. 3575



Válvula esfera esquadra para gas, H-conexión manguera

Paso total. Construcción en latón según UNE-EN 12165 cromado. Asientos PTFE. Clase MOP 5 (0 a 5 bar). Juntas de NBR. Extremos roscados según ISO 7/1 H y conexión manguera. Rango de temperatura -20°C a 60°C. Mando palomilla de aluminio, precintable. Especificaciones según norma UNE-EN 331.

Angle ball valve for gas, F-hose connection

Full bore. Chrome plated body brass UNE-EN 12165. PTFE seats. MOP 5 class (0 to 5 bar). NBR joints. Threaded ends according to ISO 7/1 F and hose connection. Temperature range -20°C to 60°C. Aluminum butterfly handle, sealable. Requirements according to standard UNE-EN 331.

R	P	L	A	M	t	D
1/2"	6	61,5	64,5	27	15,5	10,9

3575 04	1/2"	0,169	10-180	6,55
---------	------	-------	--------	------

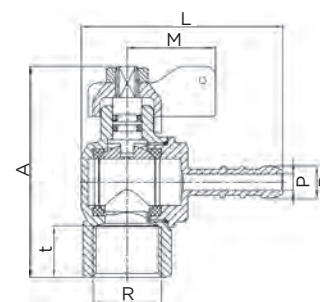

Ref. 3312



Filtro polivalente para gas

PN 16. Cuerpo latón UNE-EN 12165 cromado. Extremos rosca gas (BSP) H-H - ISO 228/1. Tamiz: acero inox. AISI 304. Luz: 50 micras. Junta tórica NBR. Temp. máx. 110°C.

In-line strainer for gas

PN 16. Body chrome plated brass UNE-EN 12165. Gas threaded ends (BSP) F-F - ISO 228/1. Sieve: stainless steel AISI 304. Light: 50 microns. NBR o-ring. Max. temp. 110°C.

R	D	L	M	A
1/2"	27	58	36	62
3/4"	33	74	43	76
1"	40	90	48	87
1 1/4"	49	115	56	105
1 1/2"	58	135	66	115
2"	71	161	80	135

3312 04	1/2"	0,144	10-160	5,93
3312 05	3/4"	0,220	8-80	10,00
3312 06	1"	0,350	6-60	14,48
3312 07	1 1/4"	0,655	5-30	27,89
3312 08	1 1/2"	0,980	2-12	41,40
3312 09	2"	1,530	1-8	64,89

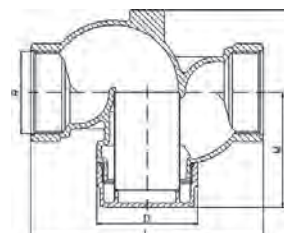



GENEBRE



ELECTROVÁLVULAS

SOLENOID VALVES



Gama completa de electroválvulas para diferentes aplicaciones en el sector industrial, en versiones de acción directa, indirecta y combinada.

Complete range of solenoid valves for different applications in the industrial sector, with 3 versions: direct, indirect and combined actioning.

ELECTROVÁLVULAS SOLENOID VALVES

PRINCIPALES TIPOS DE ELECTROVÁLVULAS MAIN TYPES OF SOLENOID VALVES

ACCIÓN DIRECTA (2 O 3 VÍAS) DIRECT ACTING (2 AND 3 WAYS)

Las electroválvulas de Acción Directa, por diseño, permiten trabajar en las siguientes condiciones:

- caudal máximo de 9 l/min (orificio máx. de 5,5 mm)
- diferencial de presión $\Delta P \geq 0$ bar entre la entrada y la salida.

The design of Direct Acting solenoid valves allow working under this conditions:

- 9 l/min maximum flow rate (max. orifice 5,5 mm)
- pressure difference $\Delta P \geq 0$ bar between inlet and outlet.

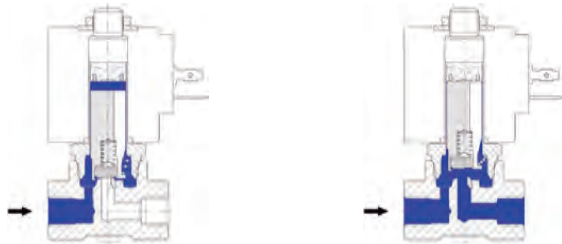

Bobina desenergizada / Coil de-energized
Electroválvula cerrada / Solenoid valve closed

Bobina energizada / Coil energized
Electroválvula abierta / Solenoid valve open

ACCIÓN INDIRECTA (2 VÍAS) INDIRECT ACTING (2 WAYS)

Las electroválvulas de Acción Indirecta, por diseño, permiten trabajar en las siguientes condiciones:

- caudal máximo 750 l/min (orificio máx. 50 mm)
- diferencial de presión mínimo ΔP 0,2 bar.

The design of Indirect Acting solenoid valves allow working under this conditions:

- 750 l/min maximum flow rate (max. orifice 50 mm)
- Pressure difference ΔP 0,2 bar minimum between inlet and outlet.

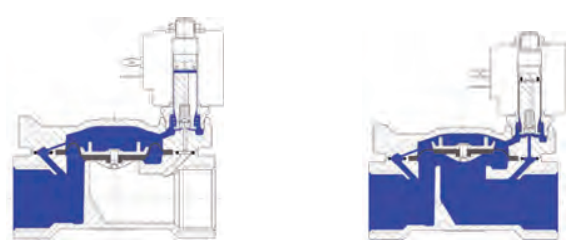

Bobina desenergizada / Coil de-energized
Electroválvula cerrada / Solenoid valve closed

Bobina energizada / Coil energized
Electroválvula abierta / Solenoid valve open

ACCIÓN MIXTA O COMBINADA (2 VÍAS) COMBINED ACTING (2WAYS)

Las electroválvulas de Acción Mixta, por diseño, permite trabajar en las siguientes condiciones:

- caudal máximo 140 l/min (orificio máx. 25 mm)
- diferencial de presión $\Delta P \geq 0$ bar entre la entrada y la salida.

The design of Combined Acting solenoid valves allow working under this conditions:

- 140 l/min maximum flow rate (max orifice 25 mm)
- pressure difference $\Delta P \geq 0$ bar between inlet and outlet.

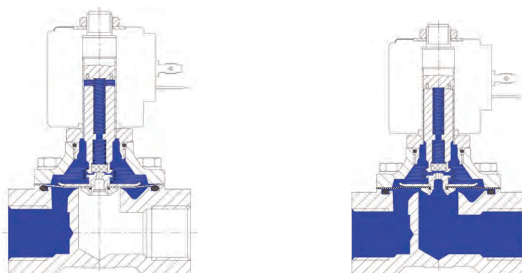

Bobina desenergizada / Coil de-energized
Electroválvula cerrada / Solenoid valve closed

Bobina energizada / Coil energized
Electroválvula abierta / Solenoid valve open

CÓMO SE CODIFICAN LA ELECTROVÁLVULAS HOW IS THE CODIFICATION FOR SOLENOID VALVES

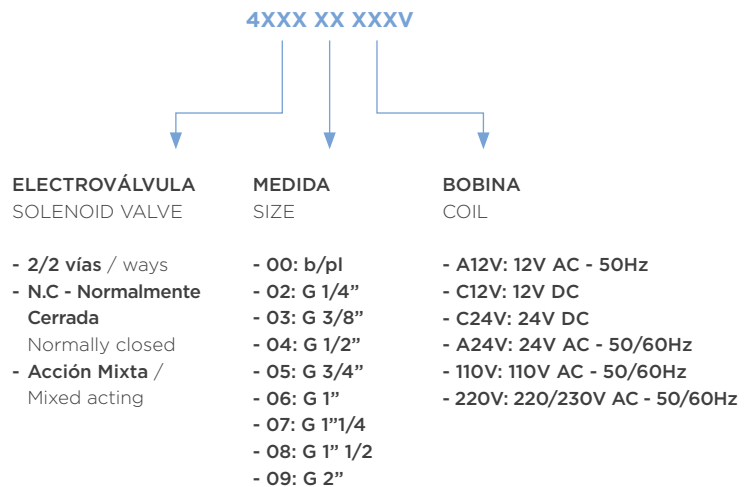

Ref. 4030 - 4031



Electroválvula de acción directa 2 vías N.C.

PN 40. Normalmente cerrada. Acción directa. Temperatura del fluido -10°C / +140°C. Cuerpo en latón UNE-EN 12165. Piloto mando Acero Inox. Cierre de FKM (otros cierres consultar). Bobina 8W.

2 ways direct acting solenoid valve N.C

PN 40. Normally closed. Direct acting. Fluid temperature -10°C / + 140°C. Body brass UNE-EN 12165. Stainless steel control pilot. FKM sealing (consult for other sealings). Coil 8W.

(4031)

Igual características anterior con bobina 14 W
Same characteristics as above with 14 W coil

Recambios

Conjunto núcleo móvil - E020V
Conjunto tubo guía - E025

Spare parts

Plunger set - E020V
Conductor pipe set - E025

Ref.	R	PN	A mm.	B mm.	C mm.	Ø mm	Presiones / Pressure			Potencia / Power		Kv
							min. bar	max. M.O.P.D. AC bar	DC bar	(watt)	l/min	
4030 01	1/8"	40	28	78	40	2,5	0	14	9	8	3,2	
4030 02	1/4"	40	28	78	40	2,5	0	14	9	8	3,2	
4031 01	1/8"	40	28	78	40	2,5	0	30	25	14	3,2	
4031 02	1/4"	40	28	78	40	2,5	0	30	25	14	3,2	

BOBINA	D (mm)	E (mm)	F (mm)
8 W	30	42	54
14 W	52	55	67

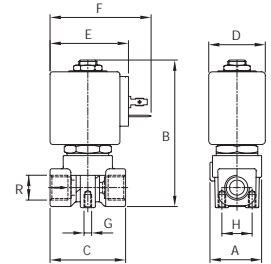

CÓDIGO CODE	MEDIDA SIZE	PESO WEIGHT	CAJA / BOX CARTON	P.V.P. € PRICE €
-------------	-------------	-------------	-------------------	------------------

4030 01	1/8"	0,31	1	40,99
4030 02	1/4"	0,31	1	40,99

4031 01	1/8"	-	1	62,50
4031 02	1/4"	-	1	64,27

E020V	-	0,020	1	14,61
E025	-	0,040	1	24,51

Ref. 4030Q



Electroválvula de acción directa 2 vías N.C.

PN 40. Normalmente cerrada. Acción directa. Temperatura del fluido -10°C / +140°C. Cuerpo en latón UNE-EN 12165. Piloto mando Acero Inox. Cierre de FKM (otros cierres consultar). Bobina 8W con certificación CE-UL-CSA-VDE.

2 ways direct acting solenoid valve N.C

PN 40. Normally closed. Direct acting. Fluid temperature -10°C / + 140°C. Body brass UNE-EN 12165. Stainless steel control pilot. FKM sealing (consult for other sealings). 8W coil certified CE-UL-CSA-VDE.

Recambios

Conjunto núcleo móvil - E020V
Conjunto tubo guía - E025

Spare parts

Plunger set - E020V
Conductor pipe set - E025

R	PN	A mm.	B mm.	C mm.	Ø mm	Presiones / Pressure			Potencia / Power		Kv
						min. bar	max. M.O.P.D. AC bar	DC bar	(watt)	l/min	
1/8"	40	28	78	40	2,5	0	14	9	8	3,2	

BOBINA	D (mm)	E (mm)	F (mm)
8W	30	42	54

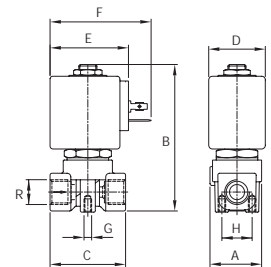

4030Q 01	1/8"	0,33	-	41,44
----------	------	------	---	-------

E020V	-	0,020	1	14,61
E025	-	0,040	1	24,51

Ref. 4032



Electroválvula de acción directa 2 vías N.C. Certificación NSF.

PN 40. Normalmente cerrada. Acción directa. Temperatura del fluido -10°C / +140°C. Cuerpo en latón UNE-EN 12165. Piloto mando Acero Inox. Cierre de FKM (otros cierres consultar). Certificación NSF. Bobina 8W con certificación CE-UL-CSA-VDE.

2 ways direct acting solenoid valve N.C. NSF certification.

PN 40. Normally closed. Direct acting. Fluid temperature -10°C / + 140°C. Body brass UNE-EN 12165. Stainless steel control pilot. FKM sealing (consult for other sealings). NSF certification. 8W coil certified CE-UL-CSA-VDE.

R	PN	A mm.	B mm.	C mm.	Ø mm	Presiones / Pressure			Potencia / Power		Kv
						min. bar	max. M.O.P.D. AC bar	DC bar	(watt)	l/min	
1/8"	40	28	78	40	2,5	0	14	9	8	3,2	

BOBINA	D (mm)	E (mm)	F (mm)
8W	30	42	54

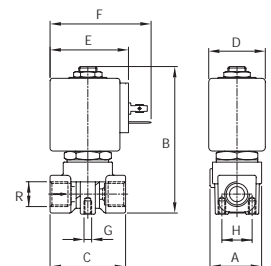

4032 01	1/8"	0,33	-	39,10
---------	------	------	---	-------

CÓDIGO CODE	MEDIDA SIZE	PESO WEIGHT	CAJA / BOX CARTON	P.V.P. € PRICE €
----------------	----------------	----------------	----------------------	---------------------

Ref. 4210



Electroválvula de acción directa 2 vías N.C.

PN 25. Normalmente cerrada. Acción directa. Temperatura del fluido -10°C / +140°C. Cuerpo en latón UNE-EN 12165. Piloto mando Acero Inox. Cierre de FKM (otros cierres consultar). Bobina 5W.

2 ways direct acting solenoid valve N.C.

PN 25. Normally closed. Direct acting. Fluid temperature -10°C / + 140°C. Body brass UNE-EN 12165. Stainless steel control pilot. FKM sealing (consult for other sealings). Coil 5W.

R	PN	A mm.	B mm.	C mm.	Ø	Presiones / Pressure			Potencia / Power		Kv
						min.	max. M.O.P.D.		(watt)	l/min	
					mm	bar	AC bar	DC bar			
1/8"	25	25	56	30	2,3	0	18	8	5	2,3	

BOBINA	D (mm)	E (mm)	F (mm)
5W	22	28	40

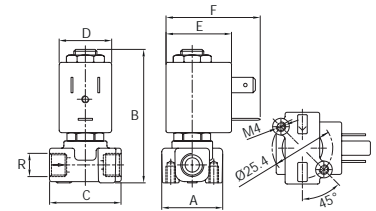

4210 01	1/8"	0,13	1	30,54
---------	------	------	---	--------------

Ref. 4220



Electroválvula de acción directa 2 vías N.C.

PN 40. Normalmente cerrada. Acción directa. Temperatura del fluido -10°C / +140°C. Cuerpo en latón UNE-EN 12165. Piloto mando Acero Inox. Cierre de FKM. Bobina 8W.

2 ways direct acting solenoid valve N.C.

PN 40. Normally closed. Direct acting. Fluid temperature -10°C / + 140°C. Body brass UNE-EN 12165. Stainless steel control pilot. FKM sealing. Coil 8W.

Recambios

Conjunto núcleo móvil 1/8"-1/4" - E026V
Conjunto núcleo móvil 3/8"-1/2" - E027V

Spare parts

Plunger set 1/8"-1/4" - E026V
Plunger set 3/8"-1/2" - E027V

R	PN	A mm.	B mm.	C mm.	Ø	Presiones / Pressure			Potencia / Power		Kv
						min.	max. M.O.P.D.		(watt)	l/min	
					mm	bar	AC bar	DC bar			
1/8"	40	17	63	37	2,8	0	14	10	8	3,5	
1/4"	40	17	63	37	2,8	0	14	10	8	3,5	
3/8"	40	26	76	46	4,5	0	5	2	8	6,5	
1/2"	40	26	76	58	5,5	0	3	1	8	9	

BOBINA	D (mm)	E (mm)	F (mm)
8W	30	42	54

4220 01	1/8"	0,24	1	26,72
4220 02	1/4"	0,23	1	26,72
4220 03	3/8"	0,3	1	38,08
4220 04	1/2"	0,33	1	42,68

E026V	1/8" - 1/4"	0,010	1	7,50
E027V	3/8" - 1/2"	0,040	1	13,19

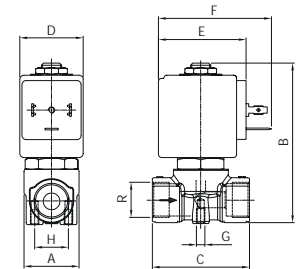

Ref. 4221



Electroválvula de acción directa 2 vías N.C.

PN 40. Normalmente cerrada. Acción directa. Temperatura del fluido -10°C / +140°C. Cuerpo en latón UNE-EN 12165. Piloto mando Acero Inox. Cierre de FKM. Bobina 8W con cable saliente.

2 ways direct acting solenoid valve N.C.

PN 40. Normally closed. Direct acting. Fluid temperature -10°C / + 140°C. Body brass UNE-EN 12165. Stainless steel control pilot. FKM sealing. Coil 8W with external wire.

Recambios

Conjunto núcleo móvil 1/8"-1/4" - E026V
Conjunto núcleo móvil 3/8"-1/2" - E027V

Spare parts

Plunger set 1/8"-1/4" - E026V
Plunger set 3/8"-1/2" - E027V

R	PN	A mm.	B mm.	C mm.	Ø	Presiones / Pressure			Potencia / Power		Kv
						min.	max. M.O.P.D.		(watt)	l/min	
					mm	bar	AC bar	DC bar			
1/4"	40	17	63	37	2,8	0	14	10	8	3,5	
3/8"	40	26	76	46	4,5	0	5	2	8	6,5	

BOBINA	D (mm)	E (mm)	F (mm)
8W	30	42	54

4221 02	1/4"	0,24	-	26,10
4221 03	3/8"	0,3	-	38,18

E026V	1/8" - 1/4"	0,010	1	7,50
E027V	3/8" - 1/2"	0,040	1	13,19

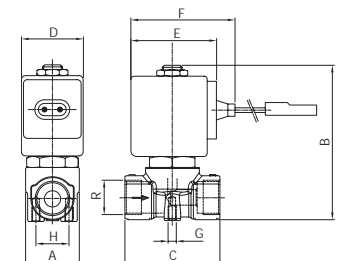

CÓDIGO CODE	MEDIDA SIZE	PESO WEIGHT	CAJA / BOX CARTON	P.V.P. € PRICE €
----------------	----------------	----------------	----------------------	---------------------

Ref. 4222



Electroválvula de acción directa 2 vías N.C.

PN 40. Normalmente cerrada. Acción directa. Temperatura del fluido -10°C / +140°C. Cuerpo en latón UNE-EN 12165. Piloto mando Acero Inox. Cierre de FKM. Bobina 8W con certificación CE-UL-CSA-VDE.

2 ways direct acting solenoid valve N.C.

PN 40. Normally closed. Direct acting. Fluid temperature -10°C / +140°C. Body brass UNE-EN 12165. Stainless steel control pilot. FKM sealing. 8W coil certified CE-UL-CSA-VDE.

Recambios

Conjunto núcleo móvil 1/8"-1/4" - E026V

Spare parts

Plunger set 1/8"-1/4" - E026V

R	PN	A mm.	B mm.	C mm.	Ø	Presiones / Pressure			Potencia / Power (watt)	Kv
						min. bar	max. M.O.P.D. AC bar	DC bar		
1/8"	40	17	63	37	2,8	0	14	10	8	3,5

BOBINA	D (mm)	E (mm)	F (mm)
8W	30	42	54

4222 01	1/8"	0,25	-	27,67
---------	------	------	---	-------

E026V	1/8" - 1/4"	0,010	1	7,50
-------	-------------	-------	---	------

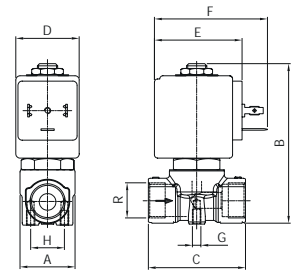

Ref. 4223RC



Electroválvula de acción directa 2 vías N.C.

PN 130. Normalmente cerrada. Acción directa. Temperatura del fluido -40°C / +180°C. Cuerpo en latón UNE-EN 12165. Piloto mando Acero Inox. Cierre de Rubí. Bobina 14W con certificación CE-UL-CSA-VDE.

2 ways direct acting solenoid valve N.C.

PN 130. Normally closed. Direct acting. Fluid temperature -40°C / +180°C. Body brass UNE-EN 12165. Stainless steel control pilot. Ruby sealing. 14W coil certified CE-UL-CSA-VDE.

R	PN	A mm.	B mm.	C mm.	Ø	Presiones / Pressure			Potencia / Power (watt)	Kv
						min. bar	max. M.O.P.D. AC bar	DC bar		
1/4"	130	28	78	40	1,2	0	130	130	14	1

BOBINA	D (mm)	E (mm)	F (mm)
14W	52	55	67

4223RC 02	1/4"	-	-	80,78
-----------	------	---	---	-------

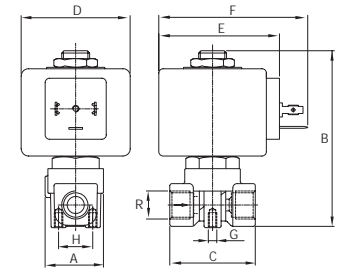

Ref. 4232



Electroválvula de acción directa 2 vías N.C.

PN 40. Base plana Normalmente cerrada. Acción directa. Temperatura del fluido -10°C / +140°C. Cuerpo en latón UNE-EN 12165. Piloto mando Acero Inox. Cierre de FKM (otros cierres consultar). Bobina 8W.

2 ways direct acting solenoid valve N.C.

PN 40. Flat base. Normally closed. Direct acting. Fluid temperature -10°C / +140°C. Body brass UNE-EN 12165. Stainless steel control pilot. FKM sealing (consult for other sealings). Coil 8W.

Recambios

Conjunto núcleo móvil - E020V

Conjunto tubo guía - E025

Spare parts

Plunger set - E020V

Conductor pipe set - E025

PN	A mm.	B mm.	C mm.	Ø	Presiones / Pressure			Potencia / Power (watt)	Kv
					min. bar	max. M.O.P.D. AC bar	DC bar		
40	32	63	32	2	0	22	16	8	2

BOBINA	D (mm)	E (mm)	F (mm)
8W	30	42	54

4232 00	b/pl	0,27	1	40,82
---------	------	------	---	-------

E020V	-	0,020	1	14,61
-------	---	-------	---	-------

E025	-	0,040	1	24,51
------	---	-------	---	-------

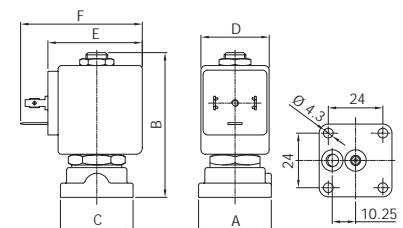

CÓDIGO CODE	MEDIDA SIZE	PESO WEIGHT	CAJA / BOX CARTON	P.V.P. € PRICE €
----------------	----------------	----------------	----------------------	---------------------

Ref. 4250



Electroválvula de acción directa 2 vías N.C.

Normalmente cerrada. Acción directa. Temperatura del fluido +2°C / +100°C. Cuerpo en latón UNE-EN 12165, PSU y PA. Piloto mando Acero Inox. Membrana VMQ (silicona), fluido separado para distribuidores automáticos de bebidas. Bobina 8W.

2 ways direct acting solenoid valve N.C.

Normally closed. Direct acting. Fluid temperature +2°C / + 100°C. Body brass UNE-EN 12165, PSU and PA. Stainless steel control pilot. VMQ (silicon) membrane, fluid separated for automatic drink distributors. Coil 8W.

R	Ø	Presiones / Pressure			Potencia / Power		Kv
		min.	max. M.O.P.D.		(watt)	l/min	
	mm	bar	AC bar	DC bar			
1/4"	9	0	0,3	0,3	8	2,5	

BOBINA	D (mm)	E (mm)	F (mm)
8W	30	42	54

4250 02	1/4"	0,33	1	42,20
---------	------	------	---	-------

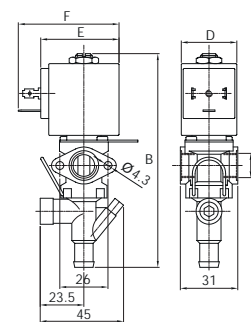

Ref. 4440



Electroválvula de acción directa 2 vías N.C.

PN 25. Normalmente cerrada. Paso angular. Acción directa. Temperatura del fluido -10°C / +140°C. Cuerpo en latón UNE-EN 12165. Piloto mando Acero Inox. Cierre de FKM. Bobina de 8W con certificación CE-UL-CSA-VDE.

2 ways direct acting solenoid valve N.C

PN 25. Normally closed. Angle bore. Direct acting. Fluid temperature -10°C / + 140°C. Body brass UNE-EN 12165. Stainless steel control pilot. FKM sealing. Coil 8W certified CE-UL-CSA-VDE.

R	PN	B	C	Ø	Presiones / Pressure			Potencia / Power		Kv
					min.	max. M.O.P.D.		(watt)	l/min	
				mm	bar	AC bar	DC bar			
1/4"	25	84	32,5	3	0	10	4	8	4	

BOBINA	D (mm)	E (mm)	F (mm)
8W	30	42	54

4440 02	1/4"	0,4	1	46,75
---------	------	-----	---	-------

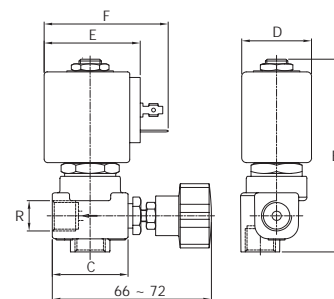

Ref. 4040 - 4041



Electroválvula de acción directa 2 vías N.A.

PN 40. Normalmente abierta. Acción directa. Temperatura del fluido -10°C / +140°C. Cuerpo en latón UNE-EN 12165. Piloto mando Acero Inox. Cierre de FKM (otros cierres consultar). Bobina 8W.

2 ways direct acting solenoid valve N.O.

PN 40. Normally open. Direct acting. Fluid temperature -10°C / + 140°C. Body brass UNE-EN 12165. Stainless steel control pilot. FKM sealing (consult for other sealings). Coil 8W.

(4041)

Igual características anterior con bobina 14 W. Same characteristics as above coil 14 W.

Recambios

Conjunto núcleo móvil + conjunto tubo guía - E030V

Spare parts

Plunger set & conductor pipe set - E030V

Ref.	R	PN	A mm.	B mm.	C mm.	Ø	Presiones / Pressure			Potencia / Power	
							min.	max. M.O.P.D.		(watt)	l/min
						mm	bar	AC bar	DC bar		
4040 01	1/8"	40	28	78	40	2,5	0	14	14	8	3,2
4040 02	1/4"	40	28	78	40	2,5	0	14	14	8	3,2
4041 02	1/4"	40	28	78	40	2,5	0	17	17	14	3,2
4041 01	1/8"	40	28	78	40	2,5	0	17	17	14	3,2

BOBINA	D (mm)	E (mm)	F (mm)
8 W	30	42	54
14 W	52	55	67

4040 01	1/8"	0,32	1	53,87
---------	------	------	---	-------

4040 02	1/4"	0,3	1	56,68
---------	------	-----	---	-------

4041 02	1/4"	-	1	68,37
---------	------	---	---	-------

4041 01	1/8"	-	1	68,37
---------	------	---	---	-------

E030V	1/8" - 1/4"	-	-	42,60
-------	-------------	---	---	-------

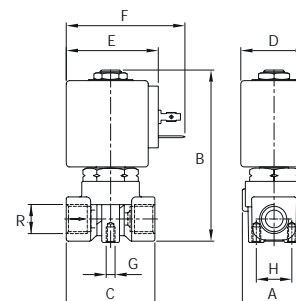

04 ELECTROVÁLVULAS SOLENOID VALVES

CÓDIGO CODE	MEDIDA SIZE	PESO WEIGHT	CAJA / BOX CARTON	P.V.P. € PRICE €
----------------	----------------	----------------	----------------------	---------------------

Ref. 4240



Electroválvula de acción directa 2 vías N.A.

PN 25. Normalmente abierta. Acción directa. Temperatura del fluido -10°C / +140°C. Cuerpo en latón UNE-EN 12165. Piloto mando Acero Inox. Cierre de FKM. Bobina 8W.

2 ways direct acting solenoid valve N.O.

PN 25. Normally opened. Direct acting. Fluid temperature -10°C / +140°C. Body brass UNE-EN 12165. Stainless steel control pilot. FKM sealing. Coil 8W.

R	PN	A	B	C	Ø	Presiones / Pressure				Potencia / Power	
						min.	max. M.O.P.D.			(watt)	l/min
1/8"	25	24	81	27	2,5	0	18	18	8	3,5	

BOBINA	D (mm)	E (mm)	F (mm)
8 W	30	42	54

4240 01 1/8" 0,25 1 39,93

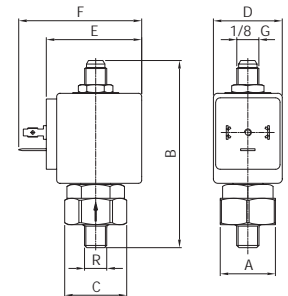

Ref. 4340



Electroválvula de acción directa 3 vías N.C

PN 40. Normalmente cerrada. Acción directa. Paso interior Ø 1,2. Paso tubo superior Ø 1,5. Temperatura del fluido -10°C / +140°C. Cuerpo en latón UNE-EN 12165. Piloto mando Acero Inox. Cierre de FKM. Bobina 5W.

3 ways direct acting solenoid valve N.C.

PN 40. Normally closed. Direct acting. Internal bore Ø 1,2. Top cone bore Ø 1,5. Fluid temperature -10°C / +140°C. Body brass UNE-EN 12165. Stainless steel control pilot. FKM sealing. Coil 5W.

R	PN	A mm.	B mm.	C mm.	Ø	Presiones / Pressure				Potencia / Power	
						min.	max. M.O.P.D.			(watt)	l/min
1/8"	40	25	56	30	1,2	0	15	15	5	1	

BOBINA	D (mm)	E (mm)	F (mm)
8 W	22	28	40

4340 01 1/8" 0,13 1 34,03

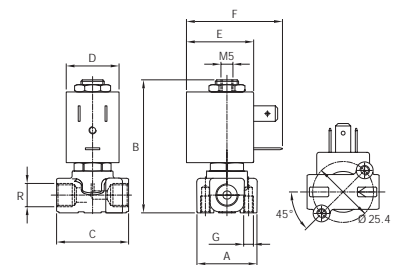

Cómo se codifican las electroválvulas

How is the codification for solenoid valves

4XXX XX XXXV

ELECTROVÁLVULA
SOLENOID VALVE

- 2/2 vías / ways
- N.C - Normalmente Cerrada
Normally closed
- Acción Mixta /
Mixed acting

MEDIDA
SIZE

- 00: b/pl
- 02: G 1/4"
- 03: G 3/8"
- 04: G 1/2"
- 05: G 3/4"
- 06: G 1"
- 07: G 1 1/4"
- 08: G 1 1/2"
- 09: G 2"

BOBINA
COIL

- A12V: 12V AC - 50Hz
- C12V: 12V DC
- C24V: 24V DC
- A24V: 24V AC - 50/60Hz
- 110V: 110V AC - 50/60Hz
- 220V: 220/230V AC - 50/60Hz

Ref. 4320 - 4322 - 4324 - 4328



(4320) Electroválvula de acción directa 3 vías N.C.

PN 40. Normalmente cerrada. Acción directa. Paso interior Ø 2,5. Paso tubo superior Ø 2,5. Temperatura del fluido -10°C / +140°C. Cuerpo en latón UNE-EN 12165. Piloto mando Acero Inox. Cierre de FKM. Bobina 8W.

(4320) 3 ways direct acting solenoid valve N.C.

PN 40. Normally closed. Direct acting. Internal bore Ø 2,5. Top cone bore Ø 2,5. Fluid temperature -10°C / + 140°C. Body brass UNE-EN 12165. Stainless steel control pilot. FKM sealing. Coil 8W.

(4322)

Igual características que la anterior. Paso interior Ø 2. Paso tubo superior Ø 2,5 Same characteristics as above. Internal bore Ø 2. Top cone bore Ø 2,5

(4324)

Igual características que la anterior. Paso interior Ø 1,5. Paso tubo superior Ø 2,5 Same characteristics as above. Internal bore Ø 1,5. Top cone bore Ø 2,5

(4328)

Igual características que la anterior. Paso interior Ø 1,5. Paso tubo superior Ø 1,5 Same characteristics as above. Internal bore Ø 1,5. Top cone bore Ø 1,5

Recambios

Conjunto núcleo móvil - E038V
Conjunto núcleo móvil - E039V
Conjunto tubo guía - E035

Spare parts

Plunger set - E038V
Plunger set - E039V
Conductor pipe set - E035

CÓDIGO CODE	MEDIDA SIZE	PESO WEIGHT	CAJA / BOX CARTON	P.V.P. € PRICE €
-------------	-------------	-------------	-------------------	------------------

4320 01	1/8"	0,32	1	45,71
4320 02	1/4"	0,31	1	45,71

4322 01	1/8"	0,32	1	45,71
4322 02	1/4"	0,31	1	45,71

4324 01	1/8"	0,257	1	45,87
4324 02	1/4"	0,31	1	45,87

4328 01	1/8"	0,32	1	57,34
4328 02	1/4"	0,33	1	57,34

E038V	-	0,020	50	15,27
E039V	-	0,030	1	18,14
E035	-	0,040	1	29,21

Ref	R	PN	A mm.	B mm.	C mm.	Ø mm	Presiones / Pressure max. M.O.P.D.			Potencia / Power (watt)	Kv l/min
							bar	AC bar	DC bar		
4320 01	1/8"	40	27,5	86	40	2,5	0	6	6	8	3,2
4320 02	1/4"	40	27,5	86	40	2,5	0	6	6	8	3,2
4322 01	1/8"	40	27,5	86	40	2	0	10	10	8	2
4322 02	1/4"	40	27,5	86	40	2	0	10	10	8	2
4324 01	1/8"	40	27,5	86	40	1,5	0	15	15	8	1,4
4324 02	1/4"	40	27,5	86	40	1,5	0	15	15	8	1,4
4328 01	1/8"	40	27,5	86	40	1,5	0	10	10	8	1,4
4328 02	1/4"	40	27,5	86	40	1,5	0	10	10	8	1,4

BOBINA	D (mm)	E (mm)	F (mm)
8 W	30	42	54

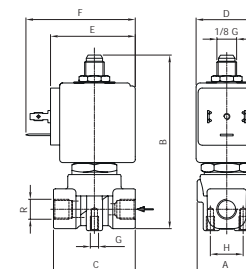

Ref. 4321



Electroválvula de acción directa 3 vías N.C.

PN 40. Normalmente cerrada. Acción directa. Paso interior Ø 3. Paso tubo superior Ø 3. Temperatura del fluido -10°C / +140°C. Cuerpo en latón UNE-EN 12165. Piloto mando Acero Inox. Cierre de FKM. Bobina 8W.

3 ways direct acting solenoid valve N.C.

PN 40. Normally closed. Direct acting. Internal bore Ø 3. Top cone bore Ø 3. Fluid temperature -10°C / + 140°C. Body brass UNE-EN 12165. Stainless steel control pilot. FKM sealing. Coil 8W.

R	PN	A mm.	B mm.	C mm.	Ø mm	Presiones / Pressure			Potencia / Power (watt)	Kv l/min
						min.	max. M.O.P.D.			
1/4"	40	27,5	86	40	3	0	3,5	3,5	8	4

BOBINA	D (mm)	E (mm)	F (mm)
8 W	30	42	54

4321 02	1/4"	0,34	-	59,94
---------	------	------	---	-------

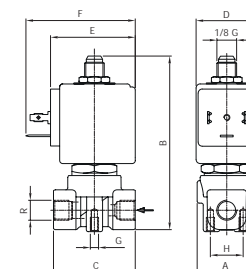

Ref. 4330 - 4332 - 4335



(4330) Electroválvula de acción directa 3 vías N.C.

PN 40. Normalmente cerrada. Acción directa. Paso interior Ø 1,5. Paso tubo superior Ø 2,5. Temperatura del fluido -10°C / +140°C. Cuerpo en latón UNE-EN 12165. Piloto mando Acero Inox. Cierre de FKM. Bobina 8W.

(4330) 3 ways direct acting solenoid valve N.C.

PN 40. Normally closed. Direct acting. Internal bore Ø 1,5. Top cone bore Ø 2,5. Fluid temperature -10°C / + 140°C. Body brass UNE-EN 12165. Stainless steel control pilot. FKM sealing. Coil 8W.

(4332)

Igual características anterior. Paso interior Ø2.
Same characteristics as above - bore Ø2.

(4335)

Igual características anterior. Paso int. Ø1,5 cono superior tipo "C".
Same characteristics as above - internal bore Ø1.5 top cone type "C".

Recambios

Conjunto núcleo móvil - E038V
Conjunto tubo guía - E035

Spare parts

Plunger set - E038V
Conductor pipe set - E035

R	PN	A mm.	B mm.	C mm.	Ø mm	Presiones / Pressure			Potencia / Power		Kv
						min. bar	max. M.O.P.D. AC bar	DC bar	(watt)	l/min	
4330 00	40	32	72	32	1,5	0	15	15	8	1,4	
4332 00	40	32	72	32	2	0	10	10	8	2	
4335 00	40	32	72	32	1,5	0	15	15	8	1,4	

BOBINA	D (mm)	E (mm)	F (mm)
8 W	30	42	54

CÓDIGO CODE	MEDIDA SIZE	PESO WEIGHT	CAJA / BOX CARTON	P.V.P. € PRICE €
-------------	-------------	-------------	-------------------	------------------

4330 00	b/pl	0,27	1	41,97
---------	------	------	---	-------

4332 00	b/pl	0,26	1	39,20
---------	------	------	---	-------

4335 00	b/pl	0,264	1	39,20
---------	------	-------	---	-------

E038V	-	0,020	50	15,27
-------	---	-------	----	-------

E035	-	0,040	1	29,21
------	---	-------	---	-------

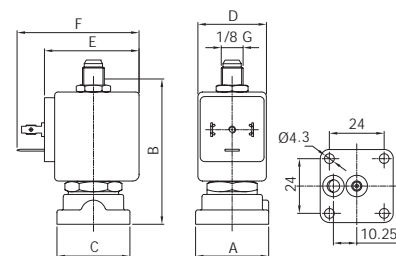

Ref. 4336



Electroválvula de acción directa 3 vías N.C. Bobina con cable saliente

PN 40. Normalmente cerrada. Acción directa. Paso interior Ø 1,5. Paso tubo superior Ø 2,5. Temperatura del fluido -10°C / +140°C. Cuerpo en latón UNE-EN 12165. Piloto mando Acero Inox. Cierre de Rubí. Bobina 8W.

3 ways direct acting solenoid valve N.C. With external wire coil

PN 40. Normally closed. Direct acting. Internal bore Ø 1,5. Top cone bore Ø 2,5. Fluid temperature -10°C / + 140°C. Body brass UNE-EN 12165. Stainless steel control pilot. Ruby sealing. Coil 8W.

R	PN	A mm.	B mm.	C mm.	Ø mm	Presiones / Pressure			Potencia / Power		Kv
						min. bar	max. M.O.P.D. AC bar	DC bar	(watt)	l/min	
4336 00	40	32	72	32	1,5	0	15	15	8	1,4	

BOBINA	D (mm)	E (mm)	F (mm)
8 W	30	42	54

4336 00	b/pl	0,26	1-50	50,99
---------	------	------	------	-------

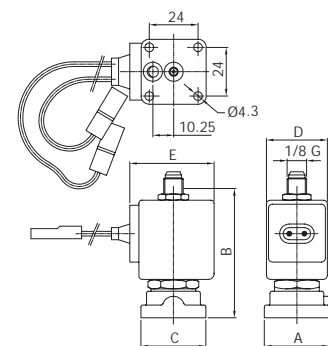

Ref. 4020 - 4022

Electroválvula de acción indirecta 2 vías N.C.

También disponible con rosca NPT (ref. 4022)
 PN 16 - PN 23 - PN 25. Normalmente cerrada. Acción indirecta. Temperatura del fluido -10°C / +90°C. Cuerpo en latón UNE-EN 12165. Piloto mando Acero Inox. Membrana de NBR (bajo demanda FKM). Asiento cierre latón UNE-EN 12165. Bobina 8W.

2 ways indirect acting solenoid valve N.C.

Also available NPT thread (ref. 4022)
 PN 16 - PN 23 - PN 25. Normally closed. Indirect acting. Fluid temperature -10°C / +90°C. Body brass UNE-EN 12165. Stainless steel control pilot. NBR membrane (FKM on request). Orifice brass UNE-EN 12165. Coil 8W.

Recambios

Conjunto núcleo móvil - E020B
 Conjunto tubo guía - E025
 Membrana 3/8"-1/2" - E025B
 Membrana 3/4"-1" - E022B
 Membrana 1 1/4"-1 1/2" - E023B
 Membrana 2" - E024B

Spare parts

Plunger set - E020B
 Conductor pipe set - E025
 Membrane 3/8"-1/2" - E025B
 Membrane 3/4"-1" - E022B
 Membrane 1 1/4"-1 1/2" - E023B
 Membrane 2" - E024B

CÓDIGO CODE	MEDIDA SIZE	PESO WEIGHT	CAJA / BOX CARTON	P.V.P. € PRICE €
----------------	----------------	----------------	----------------------	---------------------

4020 03	3/8"	0,62	1	63,62
4020 04	1/2"	0,61	1	64,26
4020 05	3/4"	1,071	1	95,17
4020 06	1"	1,28	1	104,53
4020 07	1 1/4"	3,27	1	206,68
4020 08	1 1/2"	2,94	1	218,71
4020 09	2"	5,17	1	299,07

Precios rosca NPT a consultar / NPT thread prices on request

E020B	-	0,018	1	13,27
E025	-	0,040	1	24,51
E025B	3/8"-1/2"	0,020	1	13,29
E022B	3/4"-1"	0,040	1	21,43
E023B	1 1/4"-1 1/2"	0,112	1	62,96
E024B	2"	0,182	1	75,43

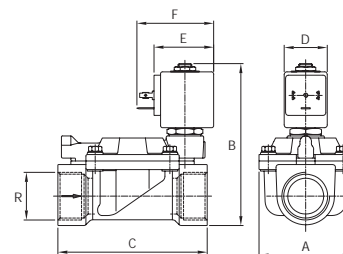

R	PN	A mm.	B mm.	C mm.	Ø mm	Presiones / Pressure				Potencia / Power (watt)	Kv l/min
						min. bar	max. M.O.P.D. AC bar	DC bar	bar		
3/8"	25	40	97	60	13	0,2	16	16	8	60	
1/2"	25	40	97	66	13	0,2	16	16	8	70	
3/4"	23	65	105	104	19	0,2	16	16	8	140	
1"	23	65	112	104	25	0,2	16	16	8	190	
1 1/4"	16	98	125	144	35	0,2	10	10	8	400	
1 1/2"	16	98	125	144	40	0,2	10	10	8	520	
2"	16	118	141	172	50	0,2	10	10	8	750	

BOBINA	D (mm)	E (mm)	F (mm)
8 W	30	42	54

Ref. 4050

Electroválvula de acción indirecta 2 vías N.C.

PN 16 - PN 20. Normalmente cerrada. Acción indirecta. Temperatura del fluido -10°C / +90°C. Cuerpo en latón UNE-EN 12165. Piloto mando Acero Inox. Membrana de NBR (otros cierres consultar). Bobina 8W.

2 ways indirect acting solenoid valve N.C.

PN 16 - PN 20. Normally closed. Indirect acting. Fluid temperature -10°C / +90°C. Body brass UNE-EN 12165. Stainless steel control pilot. NBR membrane (consult for other sealings). Coil 8W.

Recambios

Conjunto núcleo móvil - E040B
 Conjunto membrana 3/8"-1/2" - E041B
 Conjunto membrana 3/4" - E042B
 Membrana FKM 3/8" - 1/2" - E041V

Spare parts

Plunger set - E040B
 Membrane set 3/8"-1/2" - E041B
 Membrane set 3/4" - E042B
 FKM Membrane 3/8" - 1/2" - E041V

4050 03	3/8"	0,49	1	55,70
4050 04	1/2"	0,46	1	55,70
4050 05	3/4"	0,72	1	65,11

E040B	-	0,080	1	10,72
E041B	3/8" - 1/2"	0,020	1	14,44
E042B	3/4"	0,014	1	48,30
E041V	3/8" - 1/2"	-	1-1	14,44

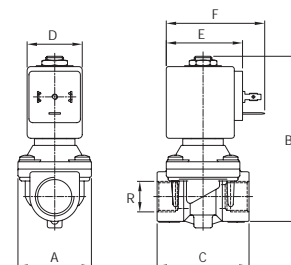

R	PN	A mm.	B mm.	C mm.	Ø mm	Presiones / Pressure				Potencia / Power (watt)	Kv l/min
						min. bar	max. M.O.P.D. AC bar	DC bar	bar		
3/8"	20	40	92	50	12	0,1	20	10	8	35	
1/2"	20	40	92	50	12	0,1	20	10	8	45	
3/4"	16	50	92	65	18	0,1	16	3	8	50	

BOBINA	D (mm)	E (mm)	F (mm)
8 W	30	42	54

Ref. 4333



Electroválvula de acción indirecta 3 vías N.C. con pistón de control piloto

PN 100. Normalmente cerrada. Acción indirecta. Paso interior Ø 12. Temperatura del fluido -20°C / +95°C. Cuerpo en latón UNE-EN 12164. Piloto mando Acero Inox. Cierre de PBT. Bobina 8W con protección IP67.

3 ways indirect acting solenoid valve N.C. with piston pilot control

PN100. Normally closed. Indirect acting. Internal bore Ø12. Fluid temperature -20°C / + 95°C. Body brass UNE-EN 12164. Stainless steel control pilot. PBT sealing. 8W coil with IP67 protection.

R	PN	Ø mm	Presiones / Pressure			Potencia / Power (watt)	Kv l/min
			min. bar	max. M.O.P.D. AC bar	DC bar		
3/4"	100	12	3	100	90	8	60

BOBINA	D (mm)	E (mm)	F (mm)
8 W	30	42	54

CÓDIGO CODE	MEDIDA SIZE	PESO WEIGHT	CAJA / BOX CARTON	P.V.P. € PRICE €
4333 00	3/4"	1,2	-	300,41

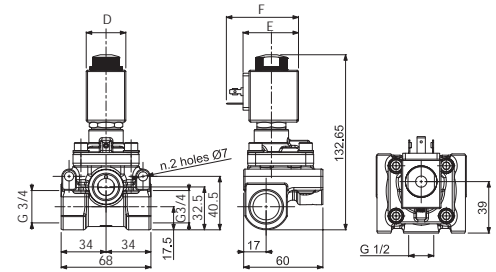

Ref. 4425 - 4425N



Electroválvula de acción indirecta 2 vías N.C.

También disponible con rosca NPT (ref. 4425N)
PN 25. Normalmente cerrada. Acción indirecta. Temperatura del fluido -40°C / +180°C. Cuerpo en latón UNE-EN 12165. Piloto mando Acero Inox. Cierre en PTFE. Bobina de 8W con certificación CE-UL-CSA-VDE con protección IP67.

2 ways indirect acting solenoid valve N.C.

Also available NPT thread (ref. 4425N)
PN 25. Normally closed. Indirect acting. Fluid temperature -40°C / + 180°C. Body brass UNE-EN 12165. Stainless steel control pilot. PTFE sealing. 8W coil certified CE-UL-CSA-VDE with IP67 protection.

Electroválvula de acción indirecta 2 vías N.C.

2 ways indirect acting solenoid valve N.C.

Recambios

Conjunto núcleo móvil - E017
Conjunto tubo guía - E025

Spare parts

Plunger set - E017
Conductor pipe set - E025

R	PN	A mm.	B mm.	C mm.	Ø mm	Presiones / Pressure			Potencia / Power (watt)	Kv l/min
						min. bar	max. M.O.P.D. AC bar	DC bar		
1/2"	25	40	107	65	13	0,9	10	10	8	50
3/4"	25	48	120	74	19	0,9	10	10	8	90
1"	25	62	130	93	25	0,9	10	10	8	160

BOBINA	D (mm)	E (mm)	F (mm)
8 W	30	42	54

4425 04	1/2"	0,65	1	184,50
4425 05	3/4"	0,9	1	200,52
4425 06	1"	1,52	1	224,64

E017	-	0,050	-	10,45
E025	-	0,040	1-30	24,51

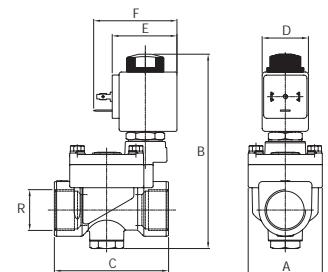

Ref. 4021

Electroválvula de acción indirecta 2 vías N.A.

PN 16 - PN 25. Normalmente abierta. Acción indirecta. Temperatura del fluido -10°C / +90°C. Cuerpo en latón UNE-EN 12165. Piloto mando Acero Inox. Membrana de NBR (bajo demanda FKM). Asiento cierre latón UNE-EN 12165. Bobina 8W.

2 ways indirect acting solenoid valve N.O.

PN 16 - PN25. Normally open. Indirect acting. Fluid temperature -10°C / +90°C. Body brass UNE-EN 12165. Stainless steel control pilot. NBR membrane (FKM on request). Orifice brass UNE-EN 12165. Coil 8W.

Recambios

Conjunto tubo guía - E030 00
Membrana 3/8"-1/2" - E025B
Membrana 3/4"-1" - E022B
Membrana 1 1/4"-1 1/2" - E023B
Membrana 2" - E024B

Spare parts

Conductor pipe set - E030 00
Membrane 3/8"-1/2" - E025B
Membrane 3/4"-1" - E022B
Membrane 1 1/4"-1 1/2" - E023B
Membrane 2" - E024B

R	PN	A mm.	B mm.	C mm.	Ø mm	Presiones / Pressure			Potencia / Power (watt)	Kv l/min
						min. bar	max. M.O.P.D. AC bar	DC bar		
3/8"	25	40	97	60	13	0,2	16	16	8	60
1/2"	25	40	97	66	13	0,2	16	16	8	70
3/4"	25	65	105	104	19	0,2	16	16	8	140
1"	25	65	112	104	25	0,2	16	16	8	190
1 1/4"	16	98	125	144	35	0,2	10	10	8	400
1 1/2"	16	98	125	144	40	0,2	10	10	8	520
2"	16	118	141	172	50	0,2	10	10	8	750

BOBINA	D (mm)	E (mm)	F (mm)
8W	30	42	54

CÓDIGO CODE	MEDIDA SIZE	PESO WEIGHT	CAJA / BOX CARTON	P.V.P. PRICE €
4021 03	3/8"	0,61	1	78,47
4021 04	1/2"	0,62	1	79,20
4021 05	3/4"	1,14	1	110,81
4021 06	1"	1,28	1	127,09
4021 07	1 1/4"	3,26	1	254,69
4021 08	1 1/2"	2,93	1	268,56
4021 09	2"	5,12	1	314,71
E030 00	-	-	1	54,58
E025B	3/8"-1/2"	0,020	1	13,29
E022B	3/4"-1"	0,040	1	21,43
E023B	1 1/4"-1 1/2"	0,112	1	62,96
E024B	2"	0,182	1	75,43

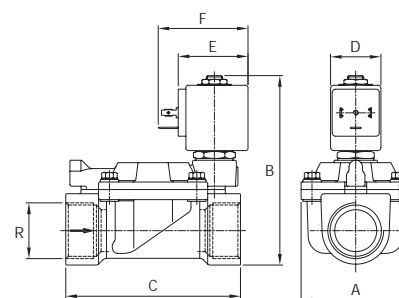

Ref. 4426

Electroválvula de acción indirecta 2 vías N.A.

PN 25. Normalmente abierta. Acción indirecta. Temperatura del fluido -40°C / +180°C. Cuerpo en latón UNE-EN 12165. Piloto mando Acero Inox. Cierre en PTFE. Bobina de 8W con certificación CE-UL-CSA-VDE con protección IP67.

2 ways indirect acting solenoid valve N.O.

PN 25. Normally opened. Indirect acting. Fluid temperature -40°C / +180°C. Body brass UNE-EN 12165. Stainless steel control pilot. PTFE sealing. 8W coil certified CE-UL-CSA-VDE with IP67 protection.

R	PN	A mm.	B mm.	C mm.	Ø mm	Presiones / Pressure			Potencia / Power (watt)	Kv l/min
						min. bar	max. M.O.P.D. AC bar	DC bar		
1/2"	25	40	107	65	13	0,9	10	10	8	50
3/4"	25	48	120	74	19	0,9	10	10	8	90
1"	25	62	130	93	25	0,9	10	10	8	160

BOBINA	D (mm)	E (mm)	F (mm)
8W	30	42	54

CÓDIGO CODE	MEDIDA SIZE	PESO WEIGHT	CAJA / BOX CARTON	P.V.P. PRICE €
4426 04	1/2"	0,632	1	206,68
4426 05	3/4"	0,1	1	224,64
4426 06	1"	1,426	1	251,55

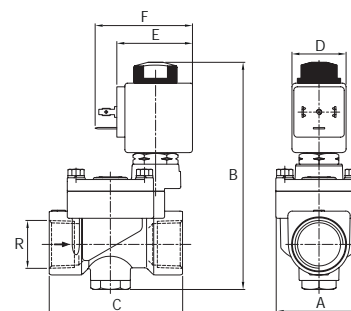

04 ELECTROVÁLVULAS SOLENOID VALVES

Ref. 4010



Electroválvula de acción mixta 2 vías N.C.

PN 16. Normalmente cerrada. Acción mixta. Temperatura del fluido -10°C / +90°C. Cuerpo en latón UNE-EN 12165. Piloto mando Acero Inox. Membrana de NBR+PA. Asiento cierre latón UNE-EN 12165. Bobina de 8W para medidas 3/8" a 3/4". Bobina de 14W para medida de 1".

2 ways mixed acting solenoid valve N.C.

PN 16. Normally closed. Mixed acting. Fluid temperature -10°C/+ 90°C. Body brass UNE-EN 12165. Stainless steel control pilot. NBR+PA membrane. Orifice brass UNE-EN 12165. 8W coil for sizes from 3/8" to 3/4". 14W coil for size of 1".

Recambios

Conjunto membrana con núcleo móvil 3/8" - E011
 Conjunto membrana con núcleo móvil 1/2"-3/4" - E012
 Conjunto membrana con núcleo móvil 1" - E013

Spare parts

Membrane set with plunger 3/8" E011
 Membrane set with plunger 1/2"-3/4" E012
 Membrane set with plunger 1" E013

R	PN	A mm.	B mm.	C mm.	Ø mm	Presiones / Pressure			Potencia / Power (watt)	Kv l/min
						min. bar	max. M.O.P.D. AC bar	DC bar		
3/8"	16	50	89	56	11	0	14	5	8	20
1/2"	16	50	100	70	16	0	14	2,5	8	40
3/4"	16	50	100	70	16	0	14	1,5	8	40
1"	16	65	112	104	25	0	14	6	14	120

BOBINA	D (mm)	E (mm)	F (mm)
8 W	30	42	54
14 W	52	55	67

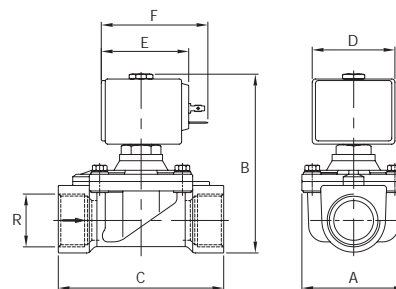

CÓDIGO CODE	MEDIDA SIZE	PESO WEIGHT	CAJA / BOX CARTON	P.V.P. € PRICE €
-------------	-------------	-------------	-------------------	------------------

4010 03	3/8"	0,47	1	71,03
4010 04	1/2"	0,744	1	74,81
4010 05	3/4"	0,658	1	74,81
4010 06	1"	1,392	1	131,60

E011	3/8"	0,001	1	35,50
E012	1/2"-3/4"	0,028	1	36,19
E013	1"	0,038	1	37,77

Ref. 4519

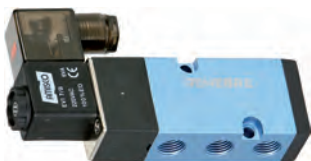

Electroválvula 5 vías

Acoplamiento conforme con la norma Namur 5 vías / 2 posiciones. Dispositivo de mando manual. Consumo 5 W. Grado de protección: IP 65 con conector y juntas. Racores: 1/4" gas. Presión de trabajo: min. 2 bar máx. 10 bar. Límite de temperaturas: -20°C +70°C.

5-ways solenoid valve

Coupling according norm Namur functioning 5 ways / 2 positions. Manual control device. Consumption 5 W. Protection: IP 65 with connector and seals. Connectors: 1/4" gas. Working pressure: min. 2 bar max. 10 bar. Temperature limits: -20°C +70°C.

4519 02 A12V	A12V	0,310	1-50	40,92
4519 02 C12V	C12V	0,310	1-50	40,92
4519 02 A24V	A24V	0,310	1-50	40,92
4519 02 C24V	C24V	0,310	1-50	40,92
4519 02 A48V	A48V	0,310	1-50	40,92
4519 02 C48V	C48V	0,001	-	40,92
4519 02 110V	110V	0,310	1-50	40,92
4519 02 220V	220V	0,310	1-50	40,92

Ref. 4100



Temporizador para descarga de condensados

Instrumento de control creado expresamente para válvulas de descarga. "Timer on" con su tiempo variable de 0,5 a 10 segundos. El "Timer off" regula a su vez el intervalo entre dos ciclos de apertura y puede variar de 0,5 a 45 min. Dos leds indican el estado de funcionamiento.

Condensate removal timer

Timer is a plug-on controller specially design for drain valves. The draining time can be set via the "on" timer between 0,5 and 10 seconds. The "off" timer allows to adjust the delay time between two draining cycles from 0,5 to 45 minutes. Two leds indicate the output status.

4100	-	0,046	1-125	52,89
------	---	-------	-------	-------

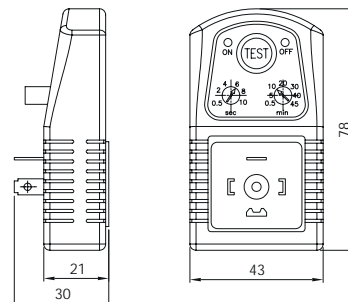

Tensión alimentación Salida / Output voltage	Corriente Salida / Output current	Consumo corriente / Power consumption	Temperatura trabajo / Working temperature	Dimensiones / Dimensions	Apertura / On time	Cierre / Off time
24 a 240VAC / DC10% 50/60 Hz	Max. 1 A	Max. 8 mA	-5°C a +60°C	78 x 43 mm	0,5 a 10 segundos	0,5 a 45 minutos

Ref. 4630

Electroválvula de acción indirecta 2 vías N.C.

PN 22 - PN 25 - PN 40. Normalmente cerrada. Acción indirecta (1/4" acción directa). Temperatura del fluido -40°C / +180°C. Cuerpo en Acero inoxidable AISI 316. Piloto mando Acero Inox. Membrana PTFE. Asiento cierre Acero inox. Bobina 8W.

2 ways indirect acting solenoid valve N.C.

PN22 - PN 25 - PN 40. Normally closed. Indirect acting (1/4" direct acting). Fluid temperature -40°C / + 180°C. Body Stainless steel AISI 316. Stainless steel control pilot. PTFE membrane. Orifice stainless steel. Coil 8W.

Recambios

Conjunto tubo guía - E046
Cjto. núcleo - E020T
Membrana 3/8"-1/2" - E049T
Membrana 3/4"-1" - E050T

Spare parts

Conductor pipe set - E046
Plunger set - E020T
Membrane 3/8"-1/2" - E049T
Membrane 3/4"-1" - E050T

R	PN	A mm.	B mm.	C mm.	Ø mm	Presiones / Pressure			Potencia / Power	
						min. bar	max. M.O.P.D. AC bar	DC bar	(watt)	I/min
1/4"	40	28	78	39	3	0	10	6	8	4
1/2"	25	40	103	73	12	0,5	10	10	8	35
3/4"	22	65	115	104	19	0,5	10	10	8	120
1"	22	65	115	104	25	0,5	10	10	8	130

BOBINA	D (mm)	E (mm)	F (mm)
8W	30	42	54

CÓDIGO CODE	MEDIDA SIZE	PESO WEIGHT	CAJA / BOX CARTON	P.V.P. € PRICE €
-------------	-------------	-------------	-------------------	------------------

4630 02	1/4"	0,371	1	108,89
4630 04	1/2"	0,6	1	397,56
4630 05	3/4"	1,29	1	520,43
4630 06	1"	1,19	1	520,43

E046	-	-	1	-
E020T	-	0,018	1	13,27
E049T	1/2"	0,020	1	32,75
E050T	3/4" - 1"	0,060	1	74,44

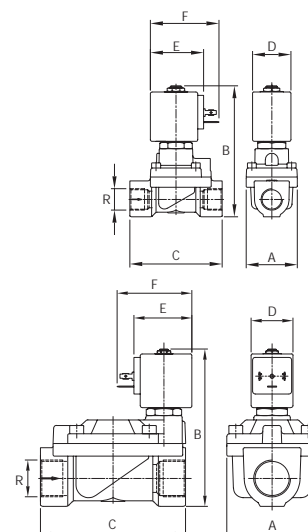

Ref. 4631

Electroválvula de acción indirecta 2 vías N.A.

PN 22 - PN 25 - PN 40. Normalmente abierta. Acción indirecta (1/4" acción directa). Temperatura del fluido -40°C / +180°C. Cuerpo en Acero inoxidable AISI 316. Piloto mando Acero Inox. Membrana PTFE. Asiento cierre Acero inox. Bobina 8W.

2 ways indirect acting solenoid valve N.O.

PN22 - PN 25 - PN 40. Normally opened. Indirect acting (1/4" direct acting). Fluid temperature -40°C / + 180°C. Body Stainless steel AISI 316. Stainless steel control pilot. PTFE membrane. Orifice stainless steel. Coil 8W.

R	PN	A mm.	B mm.	C mm.	Ø mm	Presiones / Pressure			Potencia / Power	
						min. bar	max. M.O.P.D. AC bar	DC bar	(watt)	I/min
1/4"	40	28	78	39	3	0	10	6	8	4
1/2"	25	40	103	73	12	0,5	10	10	8	35
3/4"	22	65	115	104	19	0,5	10	10	8	120

BOBINA	D (mm)	E (mm)	F (mm)
8W	30	42	54

4631 02	1/4"	0,28	-	127,07
4631 04	1/2"	0,56	-	355,39
4631 05	3/4"	1,22	-	529,61

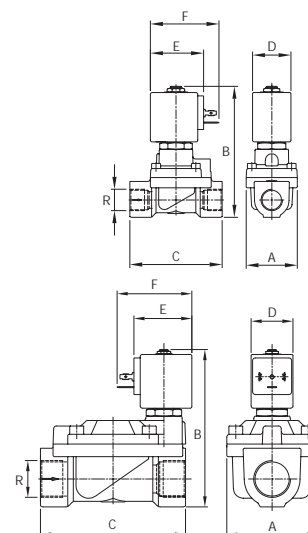

Ref. 4632



Electroválvula de acción indirecta 2 vías N.C.

PN 22 - PN 25. Normalmente cerrada. Acción indirecta. Temperatura del fluido -10°C / +140°C. Cuerpo en Acero inoxidable AISI 316. Piloto mando Acero Inox. Membrana FKM. Asiento cierre Acero inox. Bobina 8W.

2 ways indirect acting solenoid valve N.C.

PN 22 - PN 25. Normally closed. Indirect acting. Fluid temperature -10°C / + 140°C. Body Stainless steel AISI 316. Stainless steel control pilot. FKM membrane. Orifice stainless steel. Coil 8W.

Recambios

Conjunto tubo guía - E046
Conjunto núcleo móvil - E020V
Membrana 3/8"-1/2" - E052V
Membrana 3/4"-1" - E053V

Spare parts

Conductor pipe set - E046
Plunger set - E020V
Membrane 3/8"-1/2" - E052V
Membrane 3/4"-1" - E053V

R	PN	A mm.	B mm.	C mm.	Ø mm	Presiones / Pressure			Potencia / Power	
						min. bar	max. M.O.P.D. AC bar	DC bar	(watt)	Kv l/min
1/2"	25	40	103	73	12	0,1	20	20	8	35
3/4"	22	65	115	104	19	0,1	16	16	8	130
1"	22	65	115	104	25	0,1	16	16	8	160

BOBINA	D (mm)	E (mm)	F (mm)
8W	30	42	54

CÓDIGO CODE	MEDIDA SIZE	PESO WEIGHT	CAJA / BOX CARTON	P.V.P. € PRICE €
4632 04	1/2"	0,59	1	391,33
4632 05	3/4"	1,29	1	513,62
4632 06	1"	1,19	1	517,61

E046	-	-	1	-
E020V	-	0,020	1	14,61
E052V	1/2"	0,008	1	16,80
E053V	3/4" - 1"	0,080	1	51,71

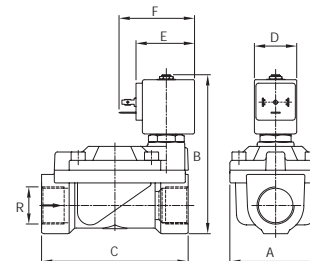

Ref. 4633



Electroválvula de acción indirecta 2 vías N.A.

PN 22 - PN 25. Normalmente abierta. Acción indirecta. Temperatura del fluido -10°C / +140°C. Cuerpo en Acero inoxidable AISI 316. Piloto mando Acero Inox. Membrana FKM. Asiento cierre Acero inox. Bobina 8W.

2 ways indirect acting solenoid valve N.O.

PN 22 - PN 25. Normally opened. Indirect acting. Fluid temperature -10°C / + 140°C. Body Stainless steel AISI 316. Stainless steel control pilot. FKM membrane. Orifice stainless steel. Coil 8W.

R	PN	A mm.	B mm.	C mm.	Ø mm	Presiones / Pressure			Potencia / Power	
						min. bar	max. M.O.P.D. AC bar	DC bar	(watt)	Kv l/min
1/2"	25	40	103	73	12	0,1	20	20	8	35
3/4"	22	65	115	104	19	0,1	16	16	8	130
1"	22	65	115	104	25	0,1	16	16	8	160

BOBINA	D (mm)	E (mm)	F (mm)
8 W	30	42	54

4633 04	1/2"	0,57	-	352,81
4633 05	3/4"	1,22	-	529,78
4633 06	1"	1,2	-	529,78

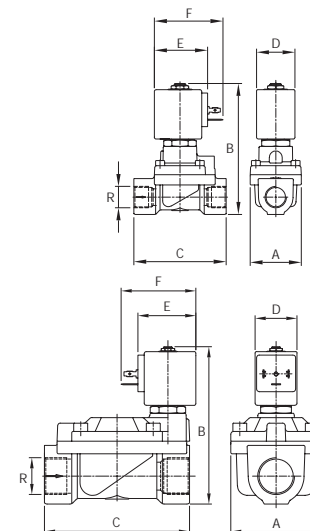

Ref. 4635



Electroválvula de acción mixta 2 vías N.C.

PN 16. Normalmente cerrada. Acción mixta. Temperatura del fluido -10°C / +140°C. Cuerpo en Acero inoxidable AISI 316. Piloto mando Acero Inox. Membrana de FKM+PA. Bobina de 8W.

2 ways mixed acting solenoid valve N.C.

PN 16. Normally closed. Mixed acting. Fluid temperature -10°C / +140°C. Body Stainless steel AISI 316. Stainless steel control pilot. FKM+PA membrane. 8W coil.

Recambios

Conjunto tubo guía - E046

Spare parts

Conductor pipe set - E046

R	PN	A mm.	B mm.	C mm.	Ø	Presiones / Pressure			Potencia / Power	Kv
						min. bar	max. M.O.P.D. AC bar	DC bar		
3/8"	16	52	92	68	15	0	14	6	8	40
1/2"	16	52	92	68	16	0	14	6	8	50
3/4"	16	58	100	75	20	0	14	6	8	60
1"	16	65	109	90	25	0	14	3	8	140

BOBINA	D (mm)	E (mm)	F (mm)
8 W	30	42	54

CÓDIGO CODE	MEDIDA SIZE	PESO WEIGHT	CAJA / BOX CARTON	P.V.P. € PRICE €
4635 03	3/8"	0,45	-	178,98
4635 04	1/2"	0,74	-	188,92
4635 05	3/4"	0,6	-	219,03
4635 06	1"	1,05	-	299,11

E046	-	-	1	-
------	---	---	---	---

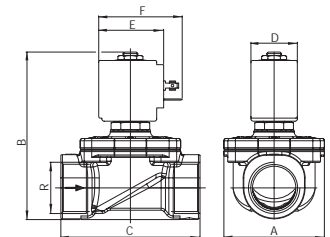

Ref. 4112



Electroválvula para gas

Normalmente cerrada. Cuerpo aluminio. Cierres NBR. Presión máxima 200 mbar. Conforme a Directiva 2014/34/CE ATEX y a Directiva Gas 2009/142/CEE.

Gas solenoid valve

Normally closed. Aluminium body. NBR sealings. Maximum pressure 200 mbar. Following Directive 2014/34/CE ATEX and Gas Directive 2009/142/CEE.

Medida/Size	A mm	B mm	C mm
1/2"	70	136	74
3/4"	70	136	74
1"	70	136	74
1 1/4"	160	187	140
1 1/2"	160	187	140
2"	160	213	140

4112 04	1/2"	0,94	1	129,12
4112 05	3/4"	1,02	1	129,12
4112 06	1"	0,92	1	147,18
4112 07	1 1/4"	3,23	1	290,56
4112 08	1 1/2"	3,17	1	290,56
4112 09	2"	3,17	1	366,75

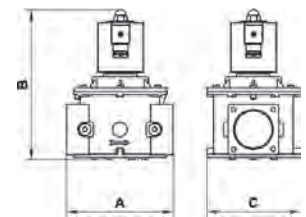

Ref. 4115



Electroválvula con rearme manual para gas

Normalmente cerrada. Cuerpo aluminio. Cierres NBR. Presión máxima 500 mbar. Conforme a Directiva 2014/34/CE ATEX y a Directiva Gas 2009/142/CEE.

Gas manual reset solenoid valve

Normally closed. Aluminium body. NBR sealings. Maximum pressure 500 mbar. Following Directive 2014/34/CE ATEX and Gas Directive 2009/142/CEE.

Medida/Size	A mm	B mm	C mm
1/2"	70	163	74
3/4"	70	163	74
1"	70	163	74

4115 04	1/2"	0,81	1	133,89
4115 05	3/4"	0,92	1	133,89
4115 06	1"	0,92	1	133,89

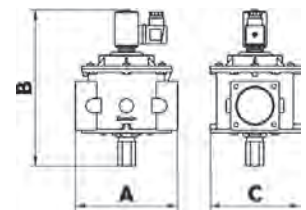

Ref. 4118



Electroválvula con rearme manual para gas

Normalmente abierta. Cuerpo aluminio. Cierres NBR. Presión máxima 500 mbar. Conforme a Directiva 2014/34/CE ATEX y a Directiva Gas 2009/142/CEE.

Gas manual reset solenoid valve

Normally opened. Aluminium body. NBR sealings. Maximum pressure 500 mbar. Following Directive 2014/34/CE ATEX and Gas Directive 2009/142/CEE.

Medida/Size	A mm	B mm	C mm
1/2"	70	111	74
3/4"	70	111	74
1"	70	111	74

4118 04	1/2"	0,57	1	59,37
4118 05	3/4"	0,56	1	59,40
4118 06	1"	0,1	1	59,40

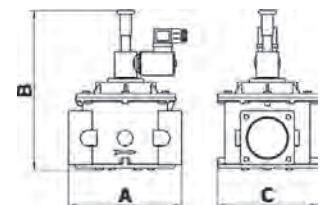

Ref. 4120



Electroválvula con rearme manual para gas

Normalmente cerrada. Cuerpo latón UNE-EN 12164. Cierres NBR. Presión máxima 500 mbar. Conforme a Directiva 2014/34/CE ATEX y a Directiva Gas 2009/142/CEE.

Gas manual reset solenoid valve

Normally closed. Brass body UNE-EN 12164. NBR sealings. Maximum pressure 500 mbar. Following Directive 2014/34/CE ATEX and Gas Directive 2009/142/CEE.

Medida/Size	A mm	B mm
1/2"	66	133
3/4"	66	133
1"	82	142

CÓDIGO CODE	MEDIDA SIZE	PESO WEIGHT	CAJA / BOX CARTON	P.V.P. € PRICE €
4120 04	1/2"	0,78	1	138,80
4120 05	3/4"	0,78	1	138,80
4120 06	1"	0,78	1	164,57

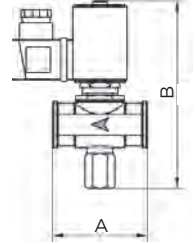

Ref. 4122



Electroválvula con rearme manual para gas

Normalmente abierta. Cuerpo latón UNE-EN 12164. Cierres NBR. Presión máxima 500 mbar. Conforme a Directiva 2014/34/CE ATEX y a Directiva Gas 2009/142/CEE.

Gas manual reset solenoid valve

Normally opened. Brass body UNE-EN 12164. NBR sealings. Maximum pressure 500 mbar. Following Directive 2014/34/CE ATEX and Gas Directive 2009/142/CEE.

Medida/Size	A mm	B mm	C mm
1/2"	66	107	34
3/4"	66	107	34
1"	82	118	44

4122 04	1/2"	0,56	1	67,48
4122 05	3/4"	0,56	1	67,48
4122 06	1"	0,1	1	102,29

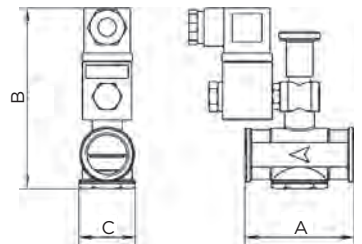

Ref. 4720 - 4721



Válvula hidráulica con electroválvula 2 vías N.C. (4720)

PN 10. Normalmente cerrada. Acción indirecta. Temperatura del fluido +5°C / +50°C. Cuerpo en hierro G-25. Hidromembrana NR reforzada con nylon. Extremos rosca gas. Con pintura epoxy. **Normalmente abierta a petición ref. 4722.**

Hydraulic valve with solenoid valve (4720)

PN 10. Normally closed. Indirect acting. Fluid temperature +5°C / +50°C. Body in iron G-25. Hydro-membrane reinforced with nylon. Gas threaded ends. With epoxy paint. **Normally opened on request ref. 4722.**

(4721)

Mismas características que la anterior pero con extremos con bridas ISO-5752-15.

Normalmente abierta a petición ref. 4723.

Same characteristics as above but with flanged ends ISO-5752-15.

Normally opened on request ref. 4723.

DN	PN	L mm.	H mm.	E mm.	Ø mm	Presiones / Pressure		Kv m/h
						min.	max.	
2"	10	175	100	120	50	1,5	10	100
3"	10	230	135	165	80	1,5	10	160
80	10	280	200	210	80	1,7	10	180
100	10	300	220	220	100	1,7	10	220
150	10	350	320	320	150	1,4	10	410

4720 09	2"	3,1	1	249,98
4720 11	3"	5,45	1	335,42

4721 11	Ø 80	13,3	1	591,73
4721 12	Ø 100	24	1	785,04
4721 14	Ø 150	50	1	1690,38

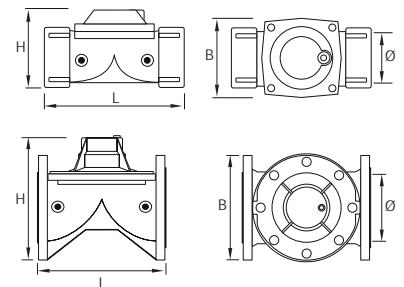

Ref. 4730 - 4731



Válvula hidráulica con flotador 2 vías N.C. (4730)

PN 10. Normalmente cerrada. Temperatura del fluido +5°C / +50°C. Cuerpo en hierro G-25. Hidromembrana NR reforzada con nylon. Extremos rosca gas. Con pintura epoxy.

2 ways floating hydraulic valve N.C. (4730)

PN 10. Normally closed. Fluid temperature +5°C / +50°C. Body in iron G-25. Hydro-membrane reinforced with nylon. Gas threaded ends. With epoxy paint.

(4731)

Mismas características que la anterior pero con extremos con bridas DIN PN 10/16.

Same characteristics as above but DIN PN 10/16 flanged ends.

DN	PN	L mm.	H mm.	E mm.	Ø	Presiones / Pressure		Kv
						mm	min.	
2"	10	175	100	120	50	1,5	10	100
3"	10	230	135	165	80	1,5	10	160

DN	PN	L mm.	H mm.	E mm.	Ø	Presiones / Pressure		Kv
						mm	min.	
80	10	280	200	210	80	1,7	10	180
100	10	300	220	220	100	1,7	10	220
150	10	350	320	320	150	1,4	10	410
200	10	400	340	340	200	1,4	10	480
250	10	450	470	405	250	1,4	10	780

CÓDIGO CODE	MEDIDA SIZE	PESO WEIGHT	CAJA / BOX CARTON	P.V.P. € PRICE €
-------------	-------------	-------------	-------------------	------------------

4730 09	2"	3,1	1-1	385,32
4730 11	3"	5,5	1-1	476,51

4731 11	Ø 80	20,5	1-1	763,80
4731 12	Ø 100	24	1-1	992,71
4731 14	Ø 150	50	1-1	1830,42
4731 16	Ø 200	65	1-1	2449,20
4731 18	Ø 250	86,5	1-1	3860,50

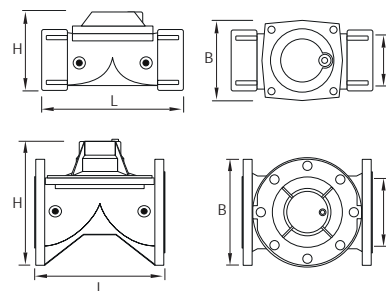

Ref. 4805



Bobina 5W Clase F (155°C)

Potencia 5W. Tolerancia de tensión en corriente alterna (+10% - 15%) y en corriente continua (+10% - 5%). Voltajes disponibles en corriente alterna 24V - 48V - 110V - 220V (50-60 Hz) y en corriente continua 12V - 24V. Temperatura máxima 155°C. Grado de protección IP65.

Class F 5W Coil (155°C)

5W power. Voltage tolerance in alternating current (10% - 15%) and in direct current (+10% - 5%). Available voltages in alternating current 24V - 48V - 110V - 220V (50-60 Hz) and in direct current 12V - 24V. Maxim Temperature 155°C. IP65 degree protection.

4805	-	0,06	-	16,01
------	---	------	---	-------

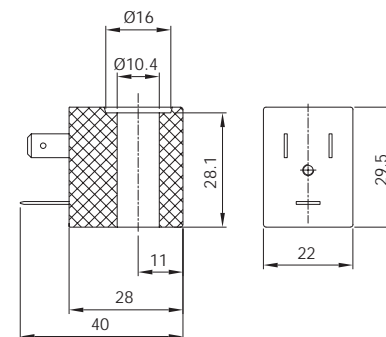

CÓDIGO CODE	MEDIDA SIZE	PESO WEIGHT	CAJA / BOX CARTON	P.V.P. € PRICE €
----------------	----------------	----------------	----------------------	---------------------

Ref. 4808 - 4974



(4808) Bobina 8W Clase F (155°C)

Potencia 8W. Tolerancia de tensión en corriente alterna (+10% - 15%) y en corriente continua (+10% - 5%). Voltajes disponibles en corriente alterna 12V - 24V - 48V - 110V - 220V - 380V (50-60 Hz) y en corriente continua 12V - 24V. Temperatura máxima 155°C. Grado de protección IP65.

(4808) Class F 8W Coil (155°C)

8W power. Voltage tolerance in alternating current (10% - 15%) and in direct current (+10% - 5%). Available voltages in alternating current 12V - 24V - 48V - 110V - 220V - 380V (50-60 Hz) and in direct current 12V - 24V. Maxim Temperature 155°C. IP65 degree protection.

(4974) Bobina 8W Clase F (155°C) con cable saliente

Potencia 8W. Con cable saliente. Tolerancia de tensión en corriente alterna (+10% - 15%) y en corriente continua (+10% - 5%). Voltajes disponibles en corriente alterna 220V (50-60 Hz). Temperatura máxima 155°C. Grado de protección IP65.

(4974) Class F 8W Coil (155°C) with external wire

8W power. External wire. Voltage tolerance in alternating current (10% - 15%) and in direct current (+10% - 5%). Available voltages in alternating current 220V (50-60 Hz). Maxim Temperature 155°C. IP65 degree protection.

4808	-	0,12	-	18,39
------	---	------	---	-------

4974	-	0,137	-	23,52
------	---	-------	---	-------

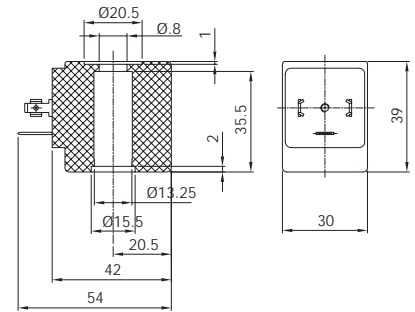

Ref. 4828



Bobina 8W Clase H (180°C)

Potencia 8W. Tolerancia de tensión en corriente alterna (+10% - 15%) y en corriente continua (+10% - 5%). Voltajes disponibles en corriente alterna 24V - 48V - 110V - 220V (50-60 Hz) y en corriente continua 12V - 24V. Temperatura máxima 180°C. Grado de protección IP65.

Class H 8W Coil (180°C)

8W power. Voltage tolerance in alternating current (10% - 15%) and in direct current (+10% - 5%). Available voltages in alternating current 24V - 48V - 110V - 220V (50-60 Hz) and in direct current 12V - 24V. Maxim Temperature 180°C. IP65 degree protection.

4828	-	0,15	-	20,71
------	---	------	---	-------

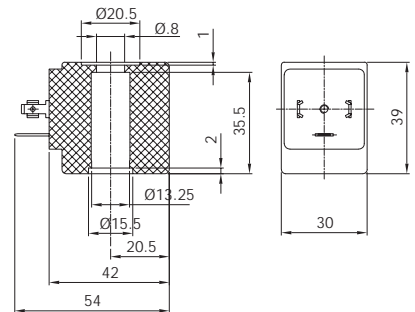

Ref. 4814



Bobina 14W Clase H (180°C) - Corriente Alterna

Potencia 14W. Tolerancia de tensión en corriente alterna (+10% - 15%). Voltajes disponibles en corriente alterna 24V - 48V - 110V - 220V (50-60 Hz). Temperatura máxima 180°C. Grado de protección IP65.

Bobina 14W Clase N (200°C) - Corriente Continua

Potencia 14W. Tolerancia de tensión en corriente continua (+10% - 5%). Voltajes disponibles en corriente continua 12V - 24V. Temperatura máxima 200°C. Grado de protección IP65.

Class H 14W Coil (180°C) - AC

14W power. Voltage tolerance in alternating current (10% - 15%). Available voltages in alternating current 24V - 48V - 110V - 220V (50-60 Hz). Maxim Temperature 180°C. IP65 degree protection.

Class N 14W Coil (200°C) - DC

14W power. Voltage tolerance in direct current (+10% - 5%). Available voltages in direct current 12V - 24V. Maxim Temperature 200°C. IP65 degree protection.

4814	-	0,39	-	52,11
------	---	------	---	-------

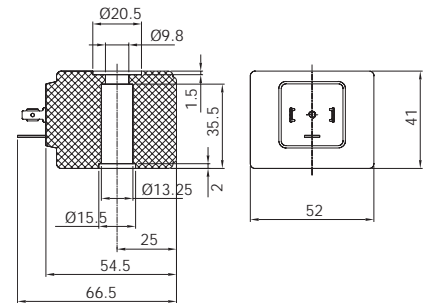

Ref. 4819



Bobina para electroválvulas 5 vías

Potencia 5W. Tolerancia de tensión en corriente alterna (+10% - 15%) y en corriente continua (+10% - 5%). Voltajes disponibles en corriente alterna 24V - 48V - 110V - 220V (50-60 Hz) y en corriente continua 12V - 24V. Clase F. Temperatura máxima 155°C. Grado de protección IP65.

5 Ways solenoid valve coil

5W power. Voltage tolerance in alternating current (10% - 15%) and in direct current (+10% - 5%). Available voltages in alternating current 24V - 48V - 110V - 220V (50-60 Hz) and in direct current 12V - 24V. F class. Maxim Temperature 155°C. IP65 degree protection.

4819	-	0,001	-	5,54
------	---	-------	---	------

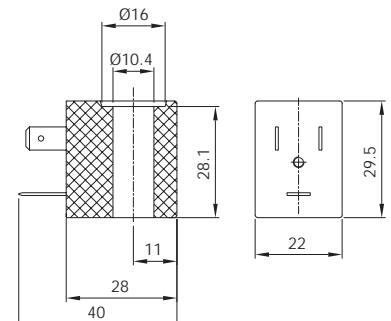

04 ELECTROVÁLVULAS
SOLENOID VALVES

Ref. 4801 05 - 4804



(4801 05) Conector tripolar 5W

Conector de 3 polos. Potencia 5W. DIN 43650. Grado de protección IP65. Multitensión, para corriente alterna y continua.

(4801 05) 3-Pole 5W connector

3-Pole connector. 5W power. DIN 43650. IP65 degree protection. . Multi tension, for AC and DC voltages

(4804) Conector tripolar 5W con señal luminosa

Conector de 3 polos. Potencia 5W. Con señal luminosa LED. DIN 43650. Grado de protección IP65. Ref. 4804 220V para voltajes Corriente Alterna. Ref. 4804 C24V para voltajes Corriente Continua.

(4804) 3-Pole 5W connector with luminous signal

3-Pole connector. 5W power. With LED luminous signal. DIN 43650. IP65 degree protection. Ref. 4804 220V for AC voltages. Ref. 4804 C24V for DC voltages.

CÓDIGO CODE	MEDIDA SIZE	PESO WEIGHT	CAJA / BOX CARTON	P.V.P. € PRICE €
-------------	-------------	-------------	-------------------	------------------

4801 05	-	0,020	25-350	2,36
---------	---	-------	--------	------

4804 220V	-	0,024	25-150	4,77
4804 C24V	-	0,100	25-150	4,77

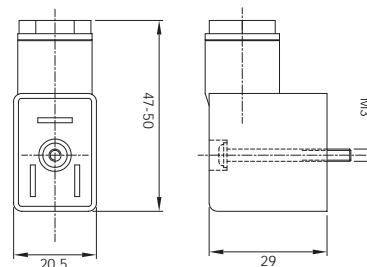

Ref. 4801 08 - 4803



(4801 08) Conector tripolar 8W

Conector de 3 polos. Potencia 8W. DIN 43650. Grado de protección IP65. Multitensión, para corriente alterna y continua.

(4801 08) 3-Pole 8W connector

3-Pole connector. 8W power. DIN 43650. IP65 degree protection. Multi tension, for AC and DC voltages.

(4803) Conector tripolar 8W con señal luminosa

Conector de 3 polos. Potencia 8W. Con señal luminosa LED. DIN 43650. Grado de protección IP65. Ref. 4803 220V para voltajes Corriente Alterna. Ref. 4803 A24V para voltajes Corriente Alterna. Ref. 4803 C24V para voltajes Corriente Continua.

(4803) 3-Pole 8W connector with luminous signal

3-Pole connector. 8W power. With LED luminous signal. DIN 43650. IP65 degree protection. Ref. 4803 220V for AC voltages. Ref. 4803 A24V for AC voltages. Ref. 4803 C24V for DC voltages.

4801 08	-	0,022	25-350	2,65
---------	---	-------	--------	------

4803 220V	-	0,018	25-350	3,71
4803 A24V	-	0,018	25-350	3,71
4803 C24V	-	0,018	25-350	3,71

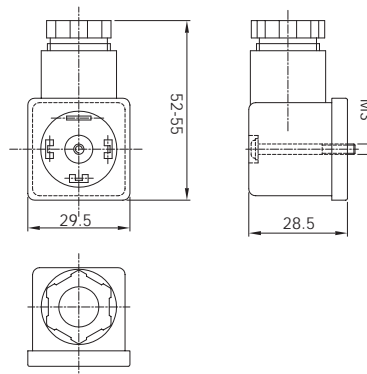

Ref. K4000



Kit antihumedad

Aplicable para válvulas de 2 vías. Grado de protección IP67.

Kit against humidity

Aplicable for 2 ways valves. IP67 Protection degree.

K4000	-	0,010	1-1	8,47
-------	---	-------	-----	------



GENEBRE



ACCESORIOS LATÓN

BRASS ACCESSORIES

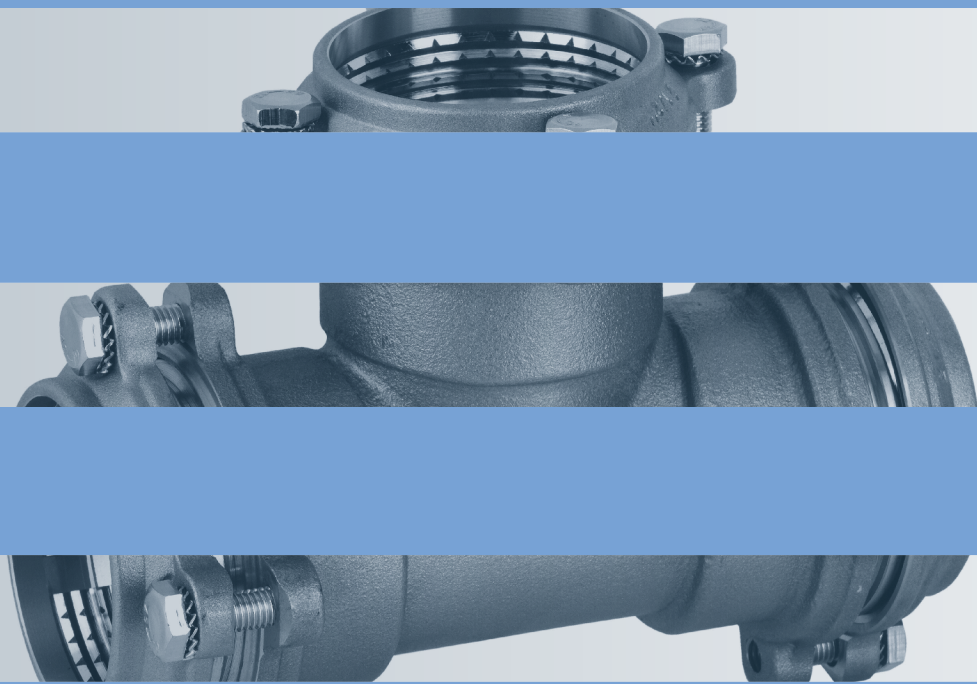

Rácores de latón forjado sistema RAC-GE para la unión hermética de tuberías de plástico. El Sistema de apriete RAC-GE garantiza una máxima seguridad y fiabilidad para la conexión de tubos en instalaciones hidrosanitarias y de calefacción.

Forged brass fittings with the RAC-GE system for a sealed joining of plastic pipes. The fittings new external structure makes the installation much easier and provides maximum security and reliability for the connection of pipes in hydrosanitary and heating installations.

ACCESORIOS LATÓN BRASS ACCESSORIES

SISTEMA DE APRIETE RAC-GE "RAC-GE" AIR TIGHT SYSTEM

La particularidad principal de este sistema radica en el anillo de apriete. El anillo está fabricado en latón especial con la elasticidad necesaria para el montaje y desmontaje del accesorio. Su geometría simétrica permite ser montado en cualquier posición.

El sistema de fijación es "por puntos" lo que evita la rotura del tubo y ofrece una mayor adaptabilidad a las posibles ovalaciones y/o imperfecciones del tubo.

No es necesario desmontar el accesorio para su instalación.

Particularmente adaptable para la unión de tubos de polietileno de baja y alta densidad.

The special feature of this system lies in the fastening necking. The necking is made out of a special type of brass with the required elasticity for assembling and disassembling the fitting. Its symmetrical shape enables it be mounted in any position.

The locking system is "by points", which prevents the cutting of the pipe and offers a better adaptation to the possible ovalizations and/or imperfections of the pipe.

It is not necessary to disassemble the fitting to install it.

Specially adaptable for connecting low and high density polyethylene pipes.



INSTRUCCIONES DE MONTAJE

Estas indicaciones evitan que cualquier tipo de deformación en el tubo impida su acoplamiento. En la figura se ilustra un ejemplo de ensamblaje del conjunto.

ASSEMBLING INSTRUCTIONS

These instructions avoid any deformation of the pipe which could prevent its correct assembling. In the figure below there is an exemple illustration of the assembling process.

1. Tapa Nut
2. Anillo apriete Necking
3. Anillo tope Washer ring
4. Tórica O'ring
5. Cuerpo Connector

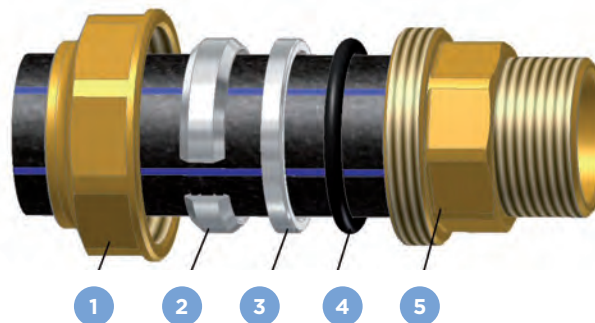

- A Desmontar la tuerca (1) del cuerpo del racor (5) e insertarla en el tubo.
- B Introducir en el tubo el anillo de apriete (2).
- C Introducir en el tubo el anillo tope (3) con la cara plana en dirección al o'ring.
- D Introducir en el tubo la junta tórica (4).
- E Situar el tubo con todos los componentes en el cuerpo del racor (5) hasta que haga tope.
- F Apretar la tuerca (1) en el cuerpo del racor (5).

- A Disassemble the nut (1) from the connector (5) and insert it into the pipe.
- B Insert the necking (2) into the pipe.
- C Insert the washer ring (3) into the pipe with the flat face in direction to the o'ring.
- D Insert the O'ring (4) into the pipe.
- E Place the pipe with all the components inside the body of the connector (5) until the pipe is fixed.
- F Tighten the nut (1) to the body of the connector (5).

Ref. 0012



Racor recto hembra

PN-16 - paso total. Construcción en latón forjado s/UNE-EN 12165. Extremo roscado gas hembra s/ISO 228/1. Conexión a tubería mediante sistema de apriete diseño Genebre "RAC-GE". Temp. de trabajo de -10°C a +90°C. Aplicable para la unión de tubo de polietileno de baja, media y alta densidad.

Straight female connector

PN 16 full bore. Forged brass UNE-EN 12165 Female gas threaded ends ISO 228/1. Genebre's designed "RAC-GE" air tight system for connection to pipe. Working temp.: -10 °C to 90 °C. Applicable for the connection of low, medium and high density polyethylene pipe.

Medida/Size	P	Ø D	A
1/2" x PE20	16,5	34	38
3/4" x PE25	22,5	41	44
1" x PE32	28,5	50	51
1 1/4" x PE40	36	60	60
1 1/2" x PE50	45	72	70
2" x PE63	55	88	83

CÓDIGO CODE	MEDIDA SIZE	PESO WEIGHT	CAJA / BOX CARTON	P.V.P. € PRICE €
0012 04	1/2" x 20	0,070	20-280	2,62
0012 05	3/4" x 25	0,107	15-210	4,07
0012 06	1" x 32	0,182	12-108	6,42
0012 07	1 1/4" x 40	0,270	6-54	10,52
0012 08	1 1/2" x 50	0,420	4-36	15,23
0012 09	2" x 63	0,730	2-24	26,36

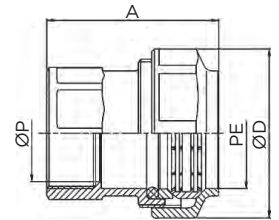

Ref. 0012



Racor recto hembra con bridas

Características de racor recto hembra. Tornillo fijación: inox M10 DIN 933-8.8. Arandela dentada: inox J10, 5 DIN 6798.

Straight female connector with flanges

Same characteristics than straight female connector. Fastening screw: inox M10 DIN 933-8.8. Serrated washer: inox J10,5. DIN 6798.

Medida/Size	P	Ø D	Ø d	A
2 1/2" x 75	65	132	76,5	93
3" x 90	80	150	92	105
4" x 110	100	176	112	123

0012 10	2 1/2" x 75	1,331	4-16	56,23
0012 11	3" x 90	1,900	2-12	82,99
0012 12	4" x 110	3,256	2-8	154,72

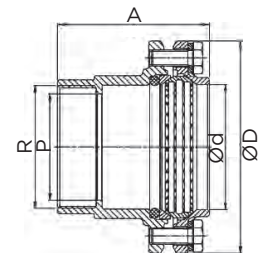

Ref. 0017



Racor recto macho

PN-16 - paso total. Construcción en latón forjado s/UNE-EN 12165. Extremo roscado gas macho s/ISO 7/1. Conexión a tubería mediante sistema de apriete diseño Genebre "RAC-GE". Temperatura de trabajo de -10°C a 90°C. Aplicable para la unión de tubo de polietileno de baja, media y alta densidad.

Straight male connector

PN 16 full bore. Forged brass UNE-EN 12165. Male gas threaded ends ISO 7/1. Genebre's designed "RAC-GE" air tight system for connection to pipe. Working temp.: -10 °C to 90 °C. Applicable for the connection of low, medium and high density polyethylene pipe.

Medida/Size	P	Ø D	A
1/2" x PE20	15	34	39
3/4" x PE25	20	41	45
1" x PE32	26	50	53
1 1/4" x PE40	34,5	60	65
1 1/2" x PE50	40	72	73
2" x PE63	51	88	89

0017 04	1/2" x 20	0,069	20-360	2,62
0017 05	3/4" x 25	0,110	15-210	4,00
0017 06	1" x 32	0,182	12-108	6,39
0017 07	1 1/4" x 40	0,295	6-54	10,53
0017 08	1 1/2" x 50	0,395	4-36	15,41
0017 09	2" x 63	0,720	2-24	26,44

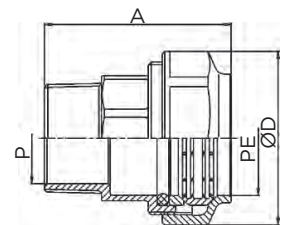

Ref. 0017



Racor recto macho con bridas

Características de racor recto macho. Tornillo fijación: inox M10 DIN 933-8.8. Arandela dentada: inox J10,5 DIN 6798.

Straight male connector with flanges

Same characteristics than straight male connector. Fastening screw: inox M10 DIN 933-8.8. Serrated washer: inox J10,5 DIN 6798.

Medida/Size	P	Ø D	Ø d	A
2 1/2" x 75	65	132	75	93
3" x 90	80	150	90	105
4" x 110	100	176	110	123

0017 10	2 1/2" x 75	1,340	4-16	55,82
0017 11	3" x 90	2,100	2-12	80,87
0017 12	4" x 110	3,100	2-8	154,72

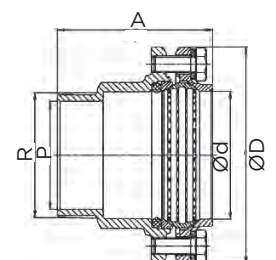

Ref. **0022**



Racor acoplamiento recto

PN-16 - paso total. Construcción en latón forjado s/UNE-EN 12165. Conexión a tubería mediante sistema de apriete diseño Genebre "RAC-GE". Temperatura de trabajo de -10°C a +90°C. Aplicable para la unión de tubo de polietileno de baja, media y alta densidad.

Straight double coupling connector

PN 16 full bore. Forged brass UNE-EN 12165. Genebre's designed "RAC-GE" air tight system for connection to pipe. Working temp.: -10°C to 90 °C. Applicable for the connection of low, medium and high density polyethylene pipe.

Medida/Size	P	Ø D	A
PE20 x PE20	16,5	34	50
PE25 x PE25	22,5	41	59
PE32 x PE32	28,5	50	71
PE40 x PE40	36	60	86
PE50 x PE50	45	72	100
PE63 x PE63	55	88	125

CÓDIGO CODE	MEDIDA SIZE	PESO WEIGHT	CAJA / BOX CARTON	P.V.P. € PRICE €
0022 04	20 x 20	0,105	12-216	4,13
0022 05	25 x 25	0,160	12-132	6,40
0022 06	32 x 32	0,240	8-64	10,17
0022 07	40 x 40	0,410	4-36	15,86
0022 08	50 x 50	0,620	2-28	25,93
0022 09	63 x 63	1,075	2-12	42,40

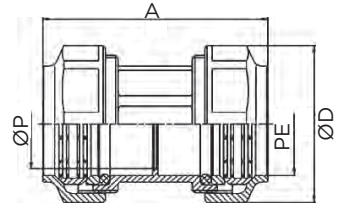

Ref. **0022**



Racor acoplamiento recto con bridas

Características de racor acoplamiento recto. Tornillo fijación: inox M10 DIN 933-8.8. Arandela dentada: inox J10,5 DIN 6798.

Straight double coupling connector with flanges

Same characteristics than straight double coupling connector. Fastening screw: inox M10 DIN 933-8.8. Serrated washer: inox J10,5 DIN 6798.

Medida/Size	P	Ø D	Ø d	A
75 x 75	65	132	75	134
90 x 90	80	150	90	155
110 x 110	100	176	110	185

0022 10	75 x 75	2,168	4-8	92,25
0022 11	90 x 90	3,149	2-6	134,41
0022 12	110 x 110	5,384	1-4	284,05

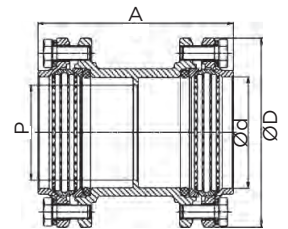

Ref. **0022R**

NEW

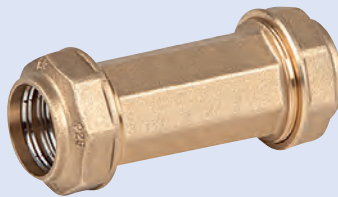

Racor acoplamiento recto para reparación

PN16. Paso total. Construcción en latón forjado s/UNE-EN 12165. Conexión a tubería mediante sistema de apriete diseño Genebre "RAC-GE". Temperatura de trabajo de -10°C a +90°C. Aplicable para la unión de tubo de polietileno de baja, media y alta densidad.

Straight double coupling connector for repair works

PN16. Full bore. Forged brass UNE-EN 12165. Genebre's design "RAC-GE" tight system for connection to pipe. Working temp. -10°C to 90°C. Applicable for the connection of low, medium and high density polyethylene pipe.

Medida/Size	P	Ø D	A
PE20 x PE20	21	34	90
PE25 x PE25	26	41	100
PE32 x PE32	32	50	115
PE40 x PE40	41	60	125
PE50 x PE50	51	72	140
PE63 x PE63	64	88	163

0022R 04	20 x 20	0,155	12-216	5,88
0022R 05	25 x 25	0,225	12-132	8,69
0022R 06	32 x 32	0,350	8-64	15,27
0022R 07	40 x 40	0,520	4-36	23,08
0022R 08	50 x 50	0,790	2-28	35,19
0022R 09	63 x 63	1,358	2-12	57,79

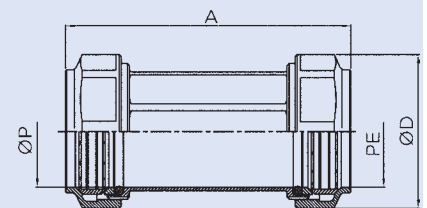

Ref. **0032**



Racor "T" triple acoplamiento

PN-16 - paso total. Construcción en latón forjado s/UNE-EN 12165. Conexión a tubería mediante sistema de apriete diseño Genebre "RAC-GE". Temperatura de trabajo de -10°C a +90°C. Aplicable para la unión de tubo de polietileno de baja, media y alta densidad.

"T" triple coupling connector

PN 16 full bore. Body and nut: forged brass UNE-EN 12165. Genebre's designed "RAC-GE" air tight system for connection to pipe. Working temp: -10 °C to 90°C. Applicable for the connection of low, medium and high density polyethylene pipe.

Medida/Size	P	Ø D	A	L
PE20 x PE20	14	34	37	74
PE25 x PE25	19	41	43	87
PE32 x PE32	24	50	53	106
PE40 x PE40	30,5	60	64	129
PE50 x PE50	38	72	77	154
PE63 x PE63	47,5	88	96	192

0032 04	20 x 20	0,160	6-84	7,28
0032 05	25 x 25	0,290	6-54	11,21
0032 06	32 x 32	0,430	4-28	17,65
0032 07	40 x 40	0,740	4-24	28,65
0032 08	50 x 50	1,230	2-12	46,12
0032 09	63 x 63	2,102	1-6	78,05

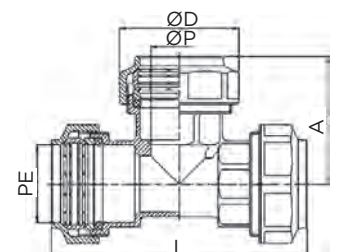

Ref. 0032



Racor "T" triple acoplamiento con bridas

Características racor "T" triple acoplamiento. Tornillo fijación: inox M10 DIN 933-8.8. Arandela dentada: inox J10,5 DIN 6798.

"T" triple coupling connector with flanges

Same characteristics than "T" triple coupling connector. Fastening screw: inox M10 DIN 933-8.8. Serrated washer: inox J10,5 DIN 6798.

Medida/Size	P	Ø D	L	A	Ø d
75 x 75	65	132	219	109	75
90 x 90	80	150	257	128	90

CÓDIGO CODE	MEDIDA SIZE	PESO WEIGHT	CAJA / BOX CARTON	P.V.P. € PRICE €
-------------	-------------	-------------	-------------------	------------------

0032 10	75 x 75	3,940	1-4	169,43
0032 11	90 x 90	5,518	1-3	254,44

Nota: El artículo 0032 12 (Ø 110) se obtiene a partir de los artículos 0037 12 + 0017 12.

Note: Item 0032 12 (Ø 110) is obtained through items 0037 12 + 0017 12.

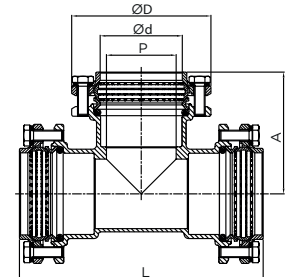

Ref. 0037



Racor "T" hembra

PN-16 - paso total. Construcción en latón forjado s/UNE-EN 12165. Extremo roscado gas hembra s/ISO 228/1. Conexión a tubería mediante sistema de apriete diseño Genebre "RAC-GE". Temperatura de trabajo de -10°C a +90°C. Aplicable para la unión de tubo de polietileno de baja, media y alta densidad.

"T" female connector

PN 16 full bore. Forged brass UNE-EN 12165. Female gas threaded ends ISO 228/1. Genebre's designed "RAC-GE" air tight system for connection to pipe. Working temp.: -10 °C to 90 °C. Applicable for the connection of low, medium and high density polyethylene pipe.

Medida/Size	P	Ø D	A	L
1/2" x PE20	14	34	23	74
3/4" x PE25	19	41	27,5	87
1" x PE32	24	50	32	106
1 1/4" x PE40	30,5	60	38	129
1 1/2" x PE50	38	72	45,5	154
2" x PE63	47,5	88	53,5	192

0037 04	1/2" x 20	0,143	8-112	5,60
0037 05	3/4" x 25	0,240	6-84	8,61
0037 06	1" x 32	0,369	4-36	13,84
0037 07	1 1/4" x 40	0,600	4-24	22,75
0037 08	1 1/2" x 50	0,960	2-14	35,61
0037 09	2" x 63	1,690	2-8	60,09

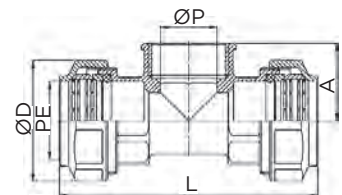

Ref. 0037



Racor "T" hembra con bridas

Características racor "T" hembra. Tornillo fijación: inox M10 DIN 933-8.8. Arandela dentada: inox J10,5 DIN 6798.

"T" female connector with flanges

Same characteristics than "T". Female connector. Fastening screw: inox M10 DIN 933-8.8. Serrated washer: inox J10,5 DIN 6798.

Medida/Size	P	Ø D	L	A	Ø t/Ø p
2 1/2" x 75	65	132	202	75	75
3" x 90	80	150	239	82	90
4" x 90	100	176	279	98	110

0037 10	2 1/2" x 75	2,800	1-6	135,34
0037 11	3" x 90	4,183	1-3	194,47
0037 12	4" x 110	7,450	1-4	347,02

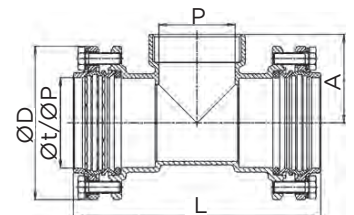

Ref. 0042



Racor "L" codo macho

PN-16 - paso total. Construcción en latón forjado s/UNE-EN 12165. Extremo roscado gas macho s/ISO 7/1. Conexión a tubería mediante sistema de apriete diseño Genebre "RAC-GE". Temperatura de trabajo de -10°C a +90°C. Aplicable para la unión de tubo de polietileno de baja, media y alta densidad.

"L" male elbow connector

PN 16 full bore. Forged brass UNE-EN 12165. Male gas threaded ends ISO 7/1. Genebre's designed "RAC-GE" air tight system for connection to pipe. Working temp.: -10 °C to 90 °C. Applicable for the connection of low, medium and high density polyethylene pipe.

Medida/Size	P	Ø D	L
1/2" x PE20	14	34	29,5
3/4" x PE25	19	41	35
1" x PE32	24	50	42,5
1 1/4" x PE40	30,5	60	51,5
1 1/2" x PE50	38	72	57,5
2" x PE63	47,5	88	69

0042 04	1/2" x 20	0,089	15-210	3,67
0042 05	3/4" x 25	0,139	12-108	5,27
0042 06	1" x 32	0,230	8-72	8,33
0042 07	1 1/4" x 40	0,400	6-36	14,78
0042 08	1 1/2" x 50	0,590	4-24	20,79
0042 09	2" x 63	1,002	2-12	35,81

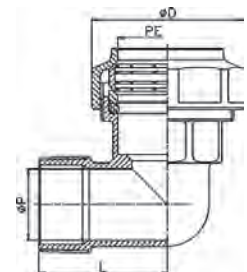

Ref. 0042



Racor "L" codo macho con bridas

Características racor "L" codo macho. Tornillo fijación: inox M10 DIN 933-8.8. Arandela dentada: inox J10, 5 DIN 6798.

"L" male elbow connector with flanges

Same characteristics than "L" male elbow connector. Fastening screw: inox M10 DIN 933-8.8. Serrated washer: inox J10,5 DIN 6798.

Medida/Size	P	Ø D	L	Ø t/Ø p
2 1/2" x 75	65	132	94	75
3" x 90	80	150	104	90

CÓDIGO CODE	MEDIDA SIZE	PESO WEIGHT	CAJA / BOX CARTON	P.V.P. € PRICE €
----------------	----------------	----------------	----------------------	---------------------

0042 10	2 1/2" x 75	1,819	1-6	85,09
0042 11	3" x 90	2,850	1-8	128,96

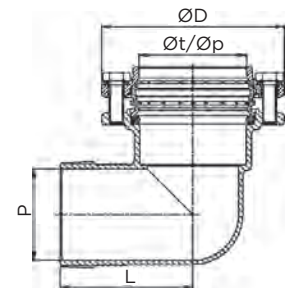

Ref. 0047



Racor "L" codo hembra

PN-16 - paso total. Construcción en latón forjado s/UNE-EN 12165. Extremo roscado gas macho s/ISO 7/1. Conexión a tubería mediante sistema de apriete diseño Genebre "RAC-GE". Temperatura de trabajo de -10°C a +90°C. Aplicable para la unión de tubo de polietileno de baja, media y alta densidad.

"L" female elbow connector

PN 16 - full bore. Forged brass UNE-EN 12165. Female gas threaded ends ISO 228/1. Genebre's designed "RAC-GE" air tight system for connection to pipe. Working temp.: -10 °C to 90 °C. Applicable for the connection of low, medium and high density polyethylene pipe.

Medida/Size	P	Ø D	L
1/2" x PE20	14	34	23
3/4" x PE25	19	41	27,5
1" x PE32	24	50	32
1 1/4" x PE40	30,5	60	38
1 1/2" x PE50	38	72	45,5
2" x PE63	47,5	88	53,5

0047 04	1/2" x 20	0,088	15-210	3,53
0047 05	3/4" x 25	0,141	10-90	5,30
0047 06	1" x 32	0,232	8-48	8,35
0047 07	1 1/4" x 40	0,380	6-36	13,95
0047 08	1 1/2" x 50	0,605	4-24	22,44
0047 09	2" x 63	1,055	2-12	37,31

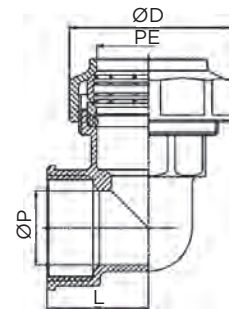

Ref. 0047



Racor "L" codo hembra con bridas

Características racor "L" codo hembra. Tornillo fijación: inox M10 DIN 933-8.8. Arandela dentada: inox J10, 5 DIN 6798.

"L" female elbow connector with flanges

Same characteristics than "L" female elbow connector. Fastening screw: inox M10 DIN 933-8.8. Serrated washer: inox J10,5 DIN 6798.

Medida/Size	P	Ø D	L	Ø t/Ø p
2 1/2" x 75	65	132	75	75
3" x 90	80	150	82	90
4" x 110	100	176	98	110

0047 10	2 1/2" x 75	1,757	1-6	86,34
0047 11	3" x 90	2,670	1-8	128,82
0047 12	4" x 110	4,668	1-4	222,78

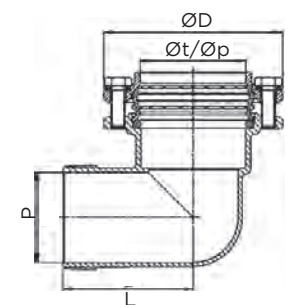

Ref. 0052



Racor "L" codo acoplamiento

PN-16 - paso total. Construcción en latón forjado s/UNE-EN 12165. Conexión a tubería mediante sistema de apriete diseño Genebre "RAC-GE". Temperatura de trabajo de -10°C a +90°C. Aplicable para la unión de tubo de polietileno de baja, media y alta densidad.

"L" elbow coupling connector

PN 16 - full bore. Forged brass UNE-EN 12165. Genebre's designed "RAC-GE" air tight system for connection to pipe. Working temp.: -10 °C to 90 °C. Applicable for the connection of low, medium and high density polyethylene pipe.

Medida/Size	P	Ø D	A
PE20 x PE20	14	34	37
PE25 x PE25	19	41	43
PE32 x PE32	24	50	53
PE40 x PE40	30,5	60	64
PE50 x PE50	38	72	77
PE63 x PE63	47,5	88	96

0052 04	20 x 20	0,193	12-108	5,02
0052 05	25 x 25	0,185	10-90	8,11
0052 06	32 x 32	0,329	6-42	12,76
0052 07	40 x 40	0,515	4-24	20,26
0052 08	50 x 50	0,800	2-18	31,47
0052 09	63 x 63	1,400	1-8	53,75

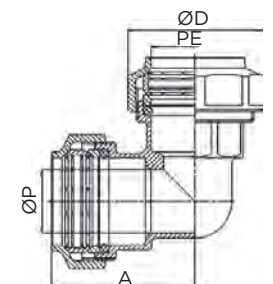

Ref. 0052



Racor "L" codo acoplamiento con bridas

Características racor "L" codo acoplamiento. Tornillo fijación: inox M10 DIN 933-8.8. Arandela dentada: inox J10, 5 DIN 6798.

"L" elbow coupling connector with flanges

Same characteristics than "L" elbow coupling connector. Fastening screw: inox M10 DIN 933-8.8. Serrated washer: inox J10, 5 DIN 6798.

Medida/Size	P	Ø D	L	Ø t/Ø p
75 x 75	65	132	115	75
90 x 90	80	150	128	90

CÓDIGO CODE	MEDIDA SIZE	PESO WEIGHT	CAJA / BOX CARTON	P.V.P. € PRICE €
----------------	----------------	----------------	----------------------	---------------------

0052 10	75 x 75	2,609	1-6	128,57
0052 11	90 x 90	3,932	1-4	182,95

Nota: El artículo 0052 12 (Ø 110) se obtiene a partir de los artículos 0047 12 + 0017 12.

Note: Item 0052 12 (Ø 110) is obtained through items 0047 12 + 0017 12.

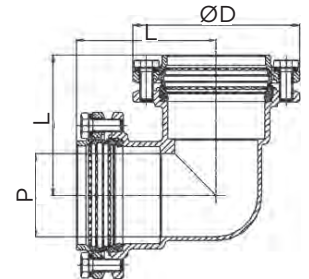

Ref. 0049



Racor "L" codo hembra con fijación a pared

PN-16 - paso total. Construcción en latón forjado s/UNE-EN 12165. Extremo roscado gas hembra s/ISO 228/1. Conexión a tubería mediante sistema de apriete diseño Genebre "RAC-GE". Temperatura de trabajo de -10°C a +90°C. Aplicable para la unión de tubo de polietileno de baja, media y alta densidad.

"L" female elbow connector with wall fixation

PN 16 full bore. Forged brass UNE-EN 12165. Female threaded ends ISO 228/1. Genebre's designed "RAC-GE" air tight system for connection to pipe. Working temp.: -10 °C to 90 °C. Applicable for the connection of low, medium and high density polyethylene pipe.

Medida/Size	P	Ø D	L	A
1/2" x PE20	14	34	23	45
3/4" x PE25	19	41	27,5	53,5
1" x PE32	24	50	32	62

0049 04	1/2" x 20	0,122	16-128	5,00
0049 05	3/4" x 25	0,186	14-84	7,12
0049 06	1" x 32	0,280	6-48	10,61

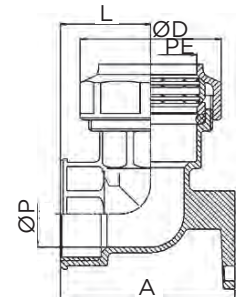

Ref. 3088



Válvula de esfera tubería PE

PN 25. Paso total. Construcción en latón s/UNE-EN 12165. Asientos PTFE. Extremos conexión a tubería mediante sistema de apriete diseño Genebre "RAC-GE". Temperatura de trabajo de -20°C a +110°C. Aplicable para la unión de tubo de polietileno de baja-media y alta densidad. Mando manual por palanca de acero.

Ball valve for PE pipe

PN 25. Full bore. Brass construction UNE-EN 12165. PTFE seats. Genebre's designed "RAC-GE" air tight system ends for connection to pipe. Working temp.: -20 °C to 110 °C. Applicable for the connection of low-medium and high density polyethylene pipe. Steel lever manual control.

DN	Ø PE	P	A	L	M
15	20	14	47	77	84
20	25	19	58	91	98
25	32	24	61	109	98

3088 04	20 x 20	0,240	6-108	7,31
3088 05	25 x 25	0,378	6-72	12,12
3088 06	32 x 32	0,574	3-36	18,16

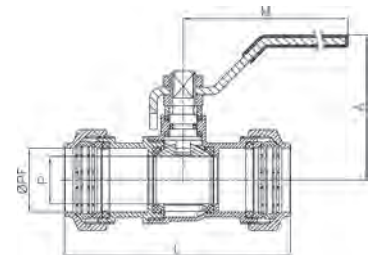

Ref. 3089



Válvula de esfera tubería PE

PN 25. Paso total. Construcción en latón s/UNE-EN 12165. Extremos roscado gas hembra s/ISO 228/1. Asiento PTFE. Conexión a tubería mediante sistema de apriete diseño Genebre "RAC-GE". Temperatura de trabajo de -20°C a +110°C. Aplicable para la unión de tubo de polietileno de baja-media y alta densidad. Mando manual por palanca de acero.

Ball valve for PE pipe

PN 25. Full bore. Brass UNE-EN 12165. Female gas threaded ends ISO 228/1. PTFE Seats. Genebre's designed "RAC-GE" air tight system for connection to pipe. Working temp.: -20 °C to 110 °C. Applicable for the connection of low-medium and high density polyethylene pipe. Steel lever manual control.

DN	Ø PE	P	A	L	M
15	20	14	47	61	84
20	25	19	58	71	98
25	32	24	61	86	98

3089 04	1/2" x 20	0,186	8-144	6,21
3089 05	3/4" x 25	0,316	6-72	10,31
3089 06	1" x 32	0,475	4-48	15,41

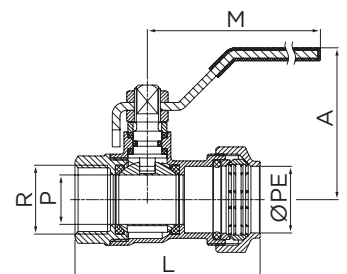

Ref. 3124



Racor acoplamiento recto con válvula de retención

PN 16. Construcción en latón forjado según UNE-EN 12165. Conexión a tubería mediante sistema de apriete diseño Genebre "RAC-GE". Temperatura de trabajo de -10°C a 90°C. Aplicable para la unión con tubo de polietileno en baja media y alta densidad. Cierre NBR vulcanizado. Muelle acero inox. AISI 304. Montaje en cualquier posición.

Straight coupling connector with check valve

PN 16. Forged brass according to UNE-EN 12165. Genebre's designed "RAC-GE" air tight system for connection to pipe. Working temp. -10°C to 90°C. Applicable for the connection of low, medium and high density polyethylene pipe. Vulcanized NBR sealing. Stainless steel AISI 304 spring. Install in any position.

Medida/Size	P	Ø D	A
PE25 x PE25	20	41	85
PE32xPE32	25	50	100
PE40 x PE40	32	60	120

CÓDIGO CODE	MEDIDA SIZE	PESO WEIGHT	CAJA / BOX CARTON	P.V.P. € PRICE €
3124 05	25x25	0,277	18-72	12,00
3124 06	32x32	0,446	10-40	19,51
3124 07	40x40	0,692	8-32	30,79

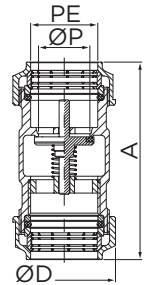

Ref. 0055



Boquilla inoxidable

Boquilla acero inoxidable AISI 304 de refuerzo para la utilización de racores en gas y agua caliente.

Stainless steel nozzle

Reinforcement stainless steel AISI 304 nozzle for using gas and hotwater connectors.

R	A	B	C	F
20	18	13,7	31	1
25	24	18,7	36	1
32	31,5	25,7	39	1
40	39	32,2	48	1
50	49	40,4	54	1
63	59,5	51	67	1
75	70	60,7	78,5	1,5
90	84	73,2	86,5	1,5
110	99	88,6	110	2

0055 04	20	0,010	100-2400	1,55
0055 05	25	0,016	75-975	1,60
0055 06	32	0,025	50-650	2,06
0055 07	40	0,038	30-420	2,61
0055 08	50	0,060	20-280	3,83
0055 09	63	0,088	10-140	4,65
0055 10	75	0,168	8-104	8,73
0055 11	90	0,245	6-78	11,80
0055 12	110	0,560	2-36	42,52

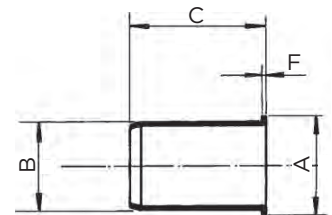

Ref. 0061



Junta tórica

O'ring

Medida/Size	Junta/O'ring
20	OR 20 x 2,5
25	OR 25 x 3
32	OR 32 x 3,5
40	OR 40 x 4
50	OR 50 x 4
63	OR 63 x 5
75	OR 75 x 7
90	OR 90 x 8
110	OR 110 x 8

0061 04	20	0,010	20-2500	0,43
0061 05	25	0,010	20-2500	0,52
0061 06	32	0,010	10-2500	0,57
0061 07	40	0,010	10-1000	0,61
0061 08	50	0,010	10-1000	0,76
0061 09	63	0,010	5-1000	1,27
0061 10	75	-	1	3,24
0061 11	90	-	1	3,96
0061 12	110	-	1	4,47

Ref. 0062



Anillo tope

Washer ring

0062 04	20	0,020	20-3000	0,63
0062 05	25	0,020	20-3000	0,73
0062 06	32	0,020	10-1200	0,86
0062 07	40	0,020	10-300	0,95
0062 08	50	0,020	5-300	1,38
0062 09	63	0,020	5-300	2,37
0062 10	75	-	1	5,57
0062 11	90	-	1	7,76
0062 12	110	-	1	14,49

Ref. 0063



Anillo apriete

Necking

0063 04	20	0,030	10-1000	1,25
0063 05	25	0,030	10-1000	1,48
0063 06	32	0,030	10-400	1,89
0063 07	40	0,030	5-1	2,63
0063 08	50	0,030	2-1	3,81
0063 09	63	0,030	1-100	4,41
0063 10	75	-	1	5,18
0063 11	90	-	1	7,25
0063 12	110	-	1	17,30

ACCESORIOS LATÓN BRASS ACCESSORIES

SISTEMA DE APRIETE VALVEX "VALVEX" AIR TIGHT SYSTEM



1. Cuerpo Body
2. Tuerca Nut
3. Junta tórica O' ring
4. Anilla junta Washer ring
5. Anillo de apriete Necking
6. Boquilla para gas Nozzle

INSTRUCCIONES DE MONTAJE

El racor VALVEX ha sido estudiado cuidadosamente para facilitar la operación del montaje y por tanto, no requiere ninguna habilidad especial para su instalación. Sin embargo, aconsejamos seguir la operación de acoplamiento en el tubo, según el orden que a continuación citamos, respetando unas simples indicaciones:

- A Desmontar la tuerca o la brida de cierre e insertarla en el tubo.
- B Introducir en el tubo el anillo de apriete (5).
- C Introducir en el tubo el anillo - junta (4).
- D Introducir en el tubo la junta tórica (3).
- E Situar el tubo con todos los componentes en el cuerpo del racor hasta que el tubo no salga del fondo del mismo.
- F Apretar la tuerca o la brida en el cuerpo del racor.

Estas simples indicaciones evitan que imperfecciones en el tubo (Ej. imperfecciones residuales en el corte) impidan el perfecto acoplamiento, y en consecuencia un perfecto cierre.

ASSEMBLY INSTRUCTIONS

The VALVEX connector has been carefully studied in order to facilitate the assembly and therefore, it does not require any special skill to install it. However, we strongly recommend you follow the assembly instructions for the pipe, in the order listed below:

- A Disassemble the nut or the closing flange and insert it into the pipe.
- B Insert the necking (5) into the pipe.
- C Insert the washer ring (4) into the pipe.
- D Insert the o'ring (3) into the pipe.
- E Place the pipe with all the components inside the body of the connector until the pipe keeps fixed inside.
- F Tighten the nut or flange to the body of the connector.

These assembling instructions avoid that any imperfections in the pipe (e.g. residuals in the cut) could prevent the perfect assembling and sealing.

Ref. 0010



Racor hembra

Female brass connector

R	A	B	C
1/2" x 20	34	27	39,5
3/4" x 25	40	33	44,88
1" x 32	50	40	49,8
1 1/4" x 40	61	50	57,4
1 1/2" x 50	71	60	65,4
2" x 63	89	75	81,3

CÓDIGO CODE	MEDIDA SIZE	PESO WEIGHT	CAJA / BOX CARTON	P.V.P. € PRICE €
----------------	----------------	----------------	----------------------	---------------------

0010 04	1/2" x 20	0,088	20-220	3,31
0010 05	3/4" x 25	0,120	15-165	4,52
0010 06	1" x 32	0,198	12-120	7,28
0010 07	1 1/4" x 40	0,330	6-60	12,17
0010 08	1 1/2" x 50	0,493	4-32	18,35
0010 09	2" x 63	0,842	2-26	31,24

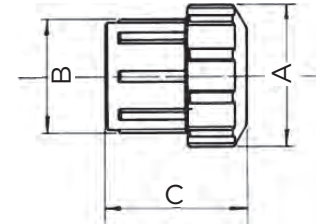

Ref. 0010

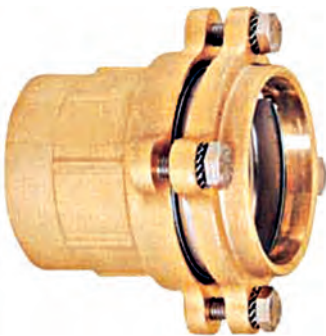

Racor hembra con bridas

Female connector with flanges

R	A	B	C
2 1/2" x 75	135	88	99,8
3" x 90	154	104	111,4
4" x 110	180	130	147

0010 10	2 1/2" x 75	1,630	4-16	66,45
0010 11	3" x 90	2,270	2-10	95,36
0010 12	4" x 110	4,535	2-4	220,16

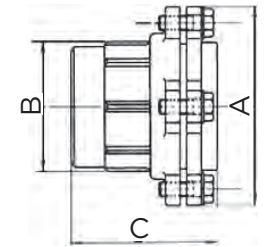

Ref. 0015

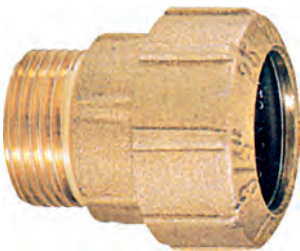

Racor macho

Male brass connector

R	A	B	C
1/2" x 20	34	27	43
3/4" x 25	40	33	48
1" x 32	50	40	54,5
1 1/4" x 40	61	50	62,5
1 1/2" x 50	71	60	67,5
2" x 63	89	75	89

0015 04	1/2" x 20	0,084	20-220	3,48
0015 05	3/4" x 25	0,120	32-165	4,57
0015 06	1" x 32	0,207	12-120	7,77
0015 07	1 1/4" x 40	0,354	6-60	13,05
0015 08	1 1/2" x 50	0,442	4-32	17,91
0015 09	2" x 63	0,843	2-26	32,16

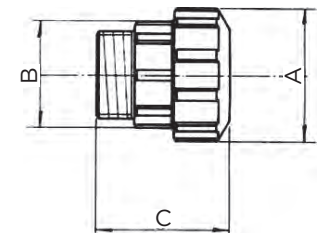

Ref. 0015



Racor macho con bridas

Male brass with flanges

R	A	B	C
2 1/2" x 75	135	88	105
3" x 90	154	104	115
4" x 110	180	130	143

0015 10	2 1/2" x 75	1,626	4-16	67,35
0015 11	3" x 90	2,230	2-10	95,22
0015 12	4" x 110	4,500	2-4	217,68

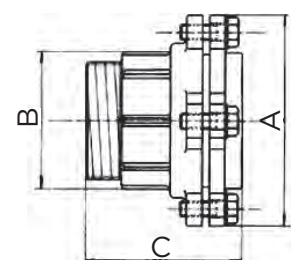

Ref. 0020

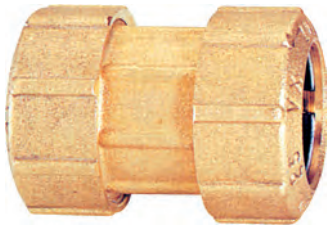

Racor acoplamiento recto
Straight coupling double connector

R	A	B	C
20	34	27	52
25	40	33	60
32	50	40	67
40	61	50	77
50	71	60	99
63	89	75	115

CÓDIGO CODE	MEDIDA SIZE	PESO WEIGHT	CAJA / BOX CARTON	P.V.P. € PRICE €
0020 04	20	0,126	12-192	5,31
0020 05	25	0,170	10-110	7,48
0020 06	32	0,302	8-64	11,55
0020 07	40	0,515	4-40	18,59
0020 08	50	0,715	2-32	27,08
0020 09	63	1,281	2-16	48,56

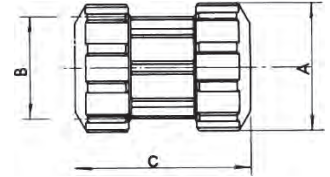

Ref. 0020

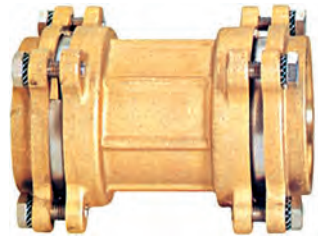

Racor acoplamiento recto con bridas
Straight coupling double connector with flanges

R	A	B	C
75	135	88	150
90	154	104	170
110	180	130	221

0020 10	75	2,625	4-8	114,55
0020 11	90	3,885	2-4	160,58
0020 12	110	7,418	1-2	392,38

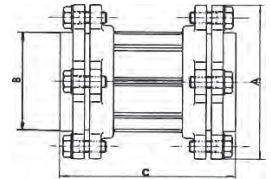

Ref. 0025



Racor acoplamiento alargado
Long coupling double connector

R	A	B	C	D
32	50	40	115	50
40	61	50	125	50
50	71	60	139	50
63	89	75	163	50

0025 06	32	0,410	6-48	18,55
0025 07	40	0,720	4-36	28,14
0025 08	50	0,840	2-20	40,99
0025 09	63	1,540	1-12	68,57

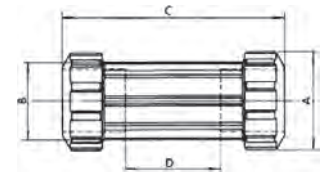

Ref. 0030



Racor "T" triple
"T" triple connector

R	A	C	E
20	34	77	38
25	40	90	45
32	50	105	52
40	61	125	62
50	71	145	72
63	89	185	92

0030 04	20	0,220	6-96	9,76
0030 05	25	0,321	6-60	13,44
0030 06	32	0,592	4-32	22,09
0030 07	40	0,920	4-24	37,69
0030 08	50	1,250	2-18	54,28
0030 09	63	2,380	1-8	98,03

Nota: Para conseguir el racor "T" de 110 x 4" pedir figura 0035 + 0015.

Note: To obtain "T" connector 110 x 4" you must request for 0035 and 0015 connector.

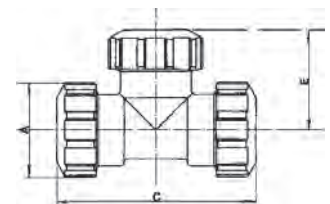

Ref. 0030



Racor "T" triple con bridas

"T" triple connector with flanges

R	A	C	E
75	135	232	115
90	154	267	133

CÓDIGO CODE	MEDIDA SIZE	PESO WEIGHT	CAJA / BOX CARTON	P.V.P. € PRICE €
----------------	----------------	----------------	----------------------	---------------------

0030 10	75	4,560	1-4	204,30
0030 11	90	6,560	1-2	301,81

Nota: Para conseguir el racor "T" de 110 x 4" pedir figura 0035 + 0015.
Note: To obtain "T" connector 110 x 4" you must request for 0035 and 0015 connector.

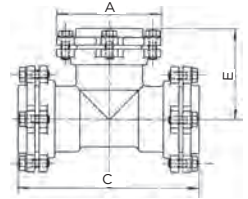

Ref. 0035



Racor "T" hembra

"T" triple female connector

R	A	C	E
1/2" x 20	34	77	22
3/4" x 25	40	90	26
1" x 32	50	105	30
1 1/4" x 40	61	125	37
1 1/2" x 50	71	145	42,5
2" x 63	89	185	51

0035 04	1/2" x 20	0,180	8-128	7,90
0035 05	3/4" x 25	0,260	6-96	11,19
0035 06	1" x 32	0,426	4-40	17,73
0035 07	1 1/4" x 40	0,725	4-36	28,52
0035 08	1 1/2" x 50	1,000	2-26	41,45
0035 09	2" x 63	1,870	2-12	76,90

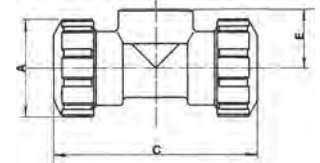

Ref. 0035



Racor "T" hembra con bridas

"T" triple female connector with flanges

R	A	C	E
2 1/2" x 75	135	226	75
3" x 90	154	259	85
4" x 110	180	314	100

0035 10	2 1/2" x 75	3,390	1-8	157,73
0035 11	3" x 90	5,256	1-4	227,49
0035 12	4" x 110	10,140	1-2	584,40

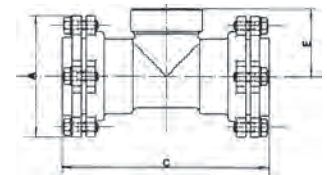

Ref. 0040



Racor "L" codo macho

"L" male elbow connector

R	A	C	E
1/2" x 20	34	36	37
3/4" x 25	40	40	42
1" x 32	50	47,5	50
1 1/4" x 40	61	55,5	60
1 1/2" x 50	71	62,5	68
2" x 63	89	76	87

0040 04	1/2" x 20	0,114	15-165	5,27
0040 05	3/4" x 25	0,164	12-120	7,13
0040 06	1" x 32	0,280	8-64	11,77
0040 07	1 1/4" x 40	0,475	6-48	20,13
0040 08	1 1/2" x 50	0,630	4-32	27,99
0040 09	2" x 63	1,126	2-24	49,69

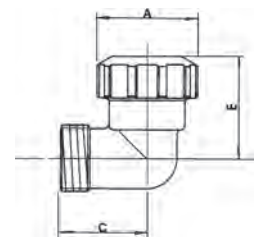

Ref. 0040



Racor "L" codo macho con bridas

"L" male elbow connector with flanges

R	A	C	E
2 1/2" x 75	135	95	111
3" x 90	154	107	133

0040 10	2 1/2" x 75	2,180	1-8	104,34
0040 11	3" x 90	3,400	1-4	155,96

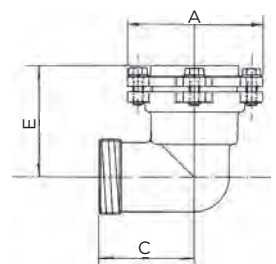

Ref. 0045



Racor codo hembra

"L" female elbow connector

R	A	C	E
1/2" x 20	34	22	38
3/4" x 25	40	26	45
1" x 32	50	30	52
1 1/4" x 40	61	37	62
1 1/2" x 50	71	42,5	71
2" x 63	89	51	92

CÓDIGO CODE	MEDIDA SIZE	PESO WEIGHT	CAJA / BOX CARTON	P.V.P. € PRICE €
----------------	----------------	----------------	----------------------	---------------------

0045 04	1/2" x 20	0,110	15-165	5,01
0045 05	3/4" x 25	0,165	12-132	6,79
0045 06	1" x 32	0,268	8-64	10,70
0045 07	1 1/4" x 40	0,465	6-48	18,45
0045 08	1 1/2" x 50	0,655	4-32	26,46
0045 09	2" x 63	1,150	2-16	47,47

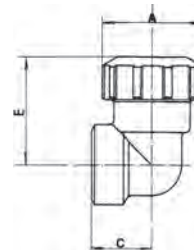

Ref. 0045



Racor codo hembra con bridas

"L" female elbow connector with flanges

R	A	C	E
2 1/2" x 75	135	75	113
3" x 90	154	85	130
4" x 110	180	100	157

0045 10	2 1/2" x 75	2,035	1-8	102,18
0045 11	3" x 90	3,166	1-8	158,26
0045 12	4" x 110	6,040	1-4	344,90

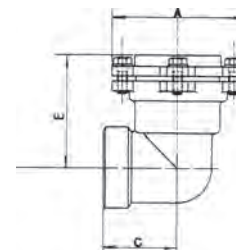

Ref. 0050



Racor "L" codo a compresión

"L" elbow compression connector

R	A	C
20	34	38
25	40	45
32	50	52
40	61	62
50	71	72
63	89	92

0050 04	20	0,158	12-120	7,05
0050 05	25	0,220	10-100	9,72
0050 06	32	0,380	6-48	15,62
0050 07	40	0,650	4-32	25,91
0050 08	50	0,930	2-16	37,70
0050 09	63	1,650	2-16	67,18

Nota: Para conseguir el racor "L" de 110 x 110 pedir figura 0045 + 0015.
Note: To obtain "L" connector 110 x 110" you must request for 0045 and 0015 connector.

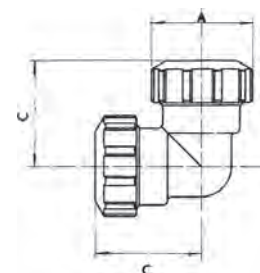

Ref. 0050



Racor "L" codo con bridas

"L" elbow compression connector with flanges

R	A	C
75	135	116
90	154	133

0050 10	75	3,090	1-8	145,53
0050 11	90	4,765	1-4	213,41

Nota: Para conseguir el racor "L" de 110 x 110 pedir figura 0045 + 0015.
Note: To obtain "L" connector 110 x 110" you must request for 0045 and 0015 connector.

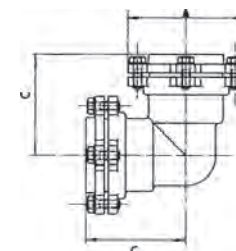

Ref. 0048



Racor "L" codo hembra
"L" female brass elbow

R	A	B	C	D
1/2" x 20	34	35	36	16
3/4" x 25	40	40	46	18
1" x 32	50	48	51	23

CÓDIGO CODE	MEDIDA SIZE	PESO WEIGHT	CAJA / BOX CARTON	P.V.P. € PRICE €
0048 04	1/2" x 20	0,150	15-120	5,67
0048 05	3/4" x 25	0,216	12-96	8,08
0048 06	1" x 32	0,334	8-64	12,46

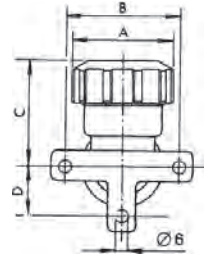

Ref. 0055



Boquilla inoxidable

Boquilla acero inoxidable AISI 304 de refuerzo para la utilización de racores en gas y agua caliente.

Stainless steel nozzle

Reinforcement stainless steel AISI 304 nozzle for using gas and hotwater connectors.

R	A	B	C	F
20	18	13,7	31	1
25	24	18,7	36	1
32	31,5	25,7	39	1
40	39	32,2	48	1
50	49	40,4	54	1
63	59,5	51	67	1
75	70	60,7	78,5	1,5
90	84	73,2	86,5	1,5
110	99	88,6	110	2

0055 04	20	0,010	100-2400	1,55
0055 05	25	0,016	75-975	1,60
0055 06	32	0,025	50-650	2,06
0055 07	40	0,038	30-420	2,61
0055 08	50	0,060	20-280	3,83
0055 09	63	0,088	10-140	4,65
0055 10	75	0,168	8-104	8,73
0055 11	90	0,245	6-78	11,80
0055 12	110	0,560	2-36	42,52

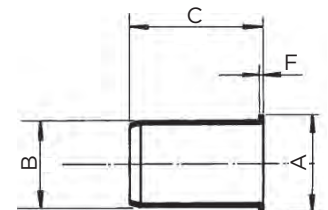

Ref. 0056



Junta tórica
O'ring

0056 04	20	0,005	20-1	0,48
0056 05	25	0,002	20-1	0,57
0056 06	32	0,003	10-1	0,63
0056 07	40	0,004	10-1	0,68
0056 08	50	0,005	10-1	0,83
0056 09	63	0,006	5-1	1,38
0056 10	75	0,007	1-1	3,53
0056 11	90	0,008	1-1	4,29
0056 12	110	0,009	1-1	4,83

Ref. 0057



Anillo junta tórica
Washer ring

0057 04	20	0,001	20-1	0,66
0057 05	25	0,003	20-1	0,74
0057 06	32	0,007	10-1	0,91
0057 07	40	0,010	10-1	1,01
0057 08	50	0,014	5-1	1,46
0057 09	63	0,018	5-1	2,51
0057 10	75	0,022	1-1	6,70
0057 11	90	0,025	1-1	8,10
0057 12	110	0,030	1-1	11,12

Ref. 0058



Anillo de apriete
Necking

0058 04	20	0,010	10-1	1,41
0058 05	25	0,020	10-1	1,63
0058 06	32	0,030	10-1	2,22
0058 07	40	0,040	5-1	3,91
0058 08	50	0,050	2-1	4,78
0058 09	63	0,060	1-1	7,06
0058 10	75	0,070	1-1	11,11
0058 11	90	0,080	1-1	15,03
0058 12	110	0,090	1-1	33,09



GENEBRE



CONTADORES DE AGUA

WATER METERS



Contadores de agua de chorro único múltiple, volumétricos, tipo Woltmann, y contadores de calorías.

Single or multiple flow, volumetric, and Woltmann type water meters, as well as thermic energy meters.

CONTADORES DE AGUA / WATER METERS

Diferentes tipos de contadores de agua:

Contadores de velocidad: Chorro único o chorro múltiple (uso domiciliario, semi-industrial) y tipo Woltmann (uso industrial, sistemas de abastecimiento).

- Chorro único, uso domiciliario, semi-industrial (6010, 6011, 6015, 6020, 6021, 6110C, 6111C, 6120C, 6121C).
- Chorro múltiple, uso domiciliario, semi-industrial (6029, 6029P).
- Tipo Woltmann, uso industrial, sistemas de abastecimiento (6060, 6060A).

Contadores Volumétricos: Pistón rotativo (uso a bajos caudales o en cualquier posición de instalación).

- Volumétrico-pistón rotativo, uso a bajos caudales, en cualquier posición de instalación (6090, 6192).

Different types of water meters:

Speed meters: Single jet or multiple jet (home, semi-industrial use) and Woltmann type (industrial use, supply systems).

- Single flow, home use, semi-industrial use (6010, 6011, 6015, 6020, 6021, 6110C, 6111C, 6120C, 6121C).
- Multiple flow, home use, semi-industrial use (6029, 6029P).
- Woltmann type, industrial use, supply systems (6060, 6060A).

Volumetric Counters: Rotary piston (use at low flow rates or in any installation position).

- Volumetric-rotary piston, use at low flow rates, in any installation position (6090, 6192).



Ref. 6110C - 6115C - 6120C



Contador de agua de chorro único (Agua fría)

Construcción: mecanismo de lectura totalmente seco, por transmisión magnética, pre-equipado con transmisor de impulsos. Contador orientable 360°. Montaje horizontal o vertical. Protección contra manipulación. Temperatura máxima 30°C. Presión máxima 16 bar. Clase de precisión 2. Aprobación CE.

Single flow water meter (Cold water)

Construction: totally dry reading mechanism, by magnetic transmission, pre-rquipped with pulse transmitter. Adjustable meter to 360°. Horizontal or vertical mounting. Protected against manipulation. Maximum temperature 30°C. Maximum pressure 16 bar. Precision class 2. EC Approval.

DN	D1	D2	L1	L2	H1	H2
15	3/4"	1/2"	110	47	17	84,5
13 - 15	3/4" x 7/8"	1/2"	114	47	17	84,5
20	1"	3/4"	130	52	21	84,5

CÓDIGO CODE	MEDIDA SIZE	PESO WEIGHT	P.V.P. € PRICE €
6110C 05	3/4" x 3/4" (DN 15)	0,642	36,44
6115C 05	3/4" x 7/8" (DN 13 - 15)	0,625	45,26
6120C 06	1" x 1" (DN 20)	0,820	45,26

Racor incluido / Included connector

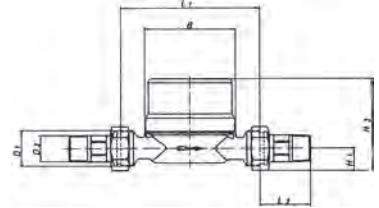

Ref. 6111C - 6121C



Contador de agua de chorro único (Agua caliente)

Construcción: mecanismo de lectura totalmente seco, por transmisión magnética, pre-equipado con transmisor de impulsos. Contador orientable 360°. Montaje horizontal o vertical. Protección contra manipulación. Temperatura máxima 90°C. Presión máxima 16 bar. Clase de precisión 2. Aprobación CE.

Single flow water meter (Hot water)

Construction: totally dry reading mechanism, by magnetic transmission, pre-rquipped with pulse transmitter. Adjustable meter to 360°. Horizontal or vertical mounting. Protected against manipulation. Maximum temperature 90°C. Maximum pressure 16 bar. Precision class 2. EC Approval.

DN	D1	D2	L1	L2	H1	H2
15	3/4"	1/2"	110	47	17	84,5
20	1"	3/4"	130	52	21	84,5

CÓDIGO CODE	MEDIDA SIZE	PESO WEIGHT	P.V.P. € PRICE €
6111C 05	3/4" x 3/4" (DN 15)	0,630	51,22
6121C 06	1" x 1" (DN 20)	0,845	46,17

Racor incluido / Included connector

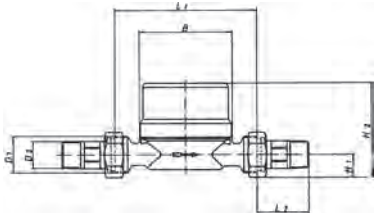

Ref. 6100



Emisor de impulsos contador de chorro único

Sensor de contacto libre de potencial. Cable de 2 hilos por 1,5 m de longitud. Para las referencias 6110C, 6115C, 6120C, 6111C y 6121C.

Pulse transmitter single flow water meter

Switch sensor potential free. 2 wires cable and 1,5 m lenght. For references 6110C, 6115C, 6120C, 6111C and 6121C.

CÓDIGO CODE	MEDIDA SIZE	PESO WEIGHT	CAJA / BOX CARTON	P.V.P. € PRICE €
6100	-	-	1-100	23,99

Ref. 6029



Contador de agua de chorro múltiple (Agua fría)

Contador de dial seco para agua fría. Montaje horizontal. Aprobación CE. Temperatura máxima 30°C. Presión máxima 16 bar. Clase de precisión 2.

Multiple flow water meter (Cold water)

Dry dial meter for cold water. Horizontal mounting. EC approval. Maximum temperature: 30°C. Maximum pressure 16 bar. Precision class: 2.

DN	d	D	b1	b2	c	g
15	3/4"	1/2"	165	259	107,5	94
20	1"	3/4"	190	294	107,5	94
25	1 1/4"	1"	260	380	117,5	98
32	1 1/2"	1 1/4"	260	384	117,5	98
40	2"	1 1/2"	300	431	141,5	122

CÓDIGO CODE	MEDIDA SIZE	PESO WEIGHT	P.V.P. € PRICE €
6029 05	3/4" x 3/4" (DN 15)	1,295	67,67
6029 06	1" x 1" (DN 20)	1,550	75,13
6029 07	1 1/4" x 1 1/4" (DN 25)	2,410	128,99
6029 08	1 1/2" x 1 1/2" (DN 32)	2,821	142,58
6029 09	2" x 2" (DN 40)	5,215	245,09

Racor incluido / Included connector

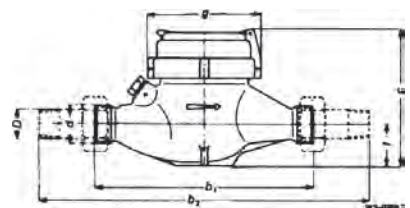

Ref. 6029P



Contador de agua de chorro múltiple (Agua fría)

Construcción: tecnopolímero. Contador de dial seco para agua fría. Montaje horizontal. Temperatura máxima 40°C. Presión máxima 16 bar. Clase de precisión B. Montaje horizontal.

Multiple flow water meter (Cold water)

Construction: plastic body. Dry dial meter for cold water. Horizontal mounting. Maximum temperature: 40°C. Maximum pressure 16 bar. Precision class: B. Horizontal mounting.

DN	d	D	b1	b2	c	g
15	3/4"	1/2"	165	259	105,5	98
20	1"	3/4"	190	294	107	98
25	1 1/4"	1"	260	380	107	98

CÓDIGO CODE	MEDIDA SIZE	PESO WEIGHT	P.V.P. € PRICE €
-------------	-------------	-------------	------------------

6029P 05	3/4" x 3/4" (DN 15)	0,695	42,10
6029P 06	1" x 1" (DN 20)	0,806	49,80
6029P 07	1 1/4" x 1 1/4" (DN 25)	0,990	90,55

Racor incluido / Included connector

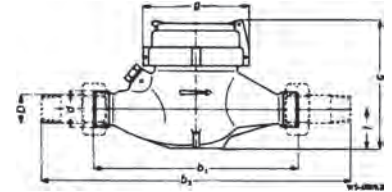

Ref. 6090



Contador de agua volumétrico - pistón rotativo (Agua fría)

Aplicación en zonas residenciales. Temperatura máxima 30°C. Presión máxima 16 bar. Aprobación CE. Clase de precisión 2.

Volumetric rotary piston water meter (Cold water)

For residential applications. Maximum temperature 30°C. Maximum pressure 16 bar. CE approval. Accuracy class 2.

DN	d	D	b1	b2	c	g
15	3/4"	1/2"	165	259	114	99

6090 05	3/4" x 3/4" (DN 15)	-	71,43
---------	---------------------	---	-------

Racor incluido / Included connector

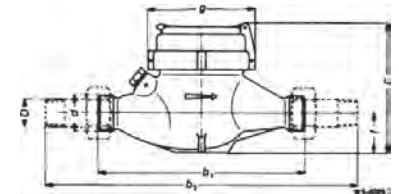

Ref. 6060



Contador de agua tipo WOLTMANN con bridas DIN

Para la medición del consumo de agua fría. Registro seco. Pérdida de presión mínima. Precisión de medición conforme a la Norma UNE-EN 14154, clase de precisión 2. Posición de montaje horizontal, vertical o inclinado (se recomienda el montaje en posición horizontal y con el medidor hacia arriba). Condiciones de trabajo: Temperatura máxima del agua: 30°C. Presión máxima de trabajo: 16 bar. Extremos conexión bridas DIN. Equipado con salida de impulsos. Aprobación CE

WOLTMANN water meter with DIN flanges

For measurement of high flows of cold water. Dry-dial. Low pressure loss. Measuring accuracy conform to UNE-EN 14154, accuracy class 2. The meter can be installed in horizontal - vertical or inclined position (a horizontal position with the register face upwards is recommended). Working conditions: Maximum water temperature: 30°C. Maximum working pressure: 16 bar. DIN flanges ends connection. Pulse output equipped. CE approval.

DN	L	H	D	D1	Agujeros/Holes (mm)	Peso/Weight (Kg)
50	200	400	165	125	4 x 18	12
65	200	400	185	145	4 x 18	13
80	225	400	200	160	8 x 18	14
100	250	400	220	180	8 x 18	16
125	250	400	250	210	8 x 18	20
150	300	500	285	240	8 x 22	31
200	350	500	340	295	12 x 22	40
250	450	710	405	355	12 x 26	83

CÓDIGO CODE	MEDIDA SIZE	P.V.P. € PRICE €
-------------	-------------	------------------

6060 09	DN50 Bridas 2" / DN50 Flanges 2"	305,59
6060 10	DN65 Bridas 2 1/2" / DN65 Flanges 2 1/2"	332,76
6060 11	DN80 Bridas 3" / DN80 Flanges 3"	346,27
6060 12	DN100 Bridas 4" / DN100 Flanges 4"	434,80
6060 13	DN125 Bridas 5" / DN125 Flanges 5"	521,13
6060 14	DN150 Bridas 6" / DN150 Flanges 6"	715,14
6060 16	DN200 Bridas 8" / DN200 Flanges 8"	850,86
6060 18	DN250 Bridas 10" / DN250 Flanges 10"	1828,66

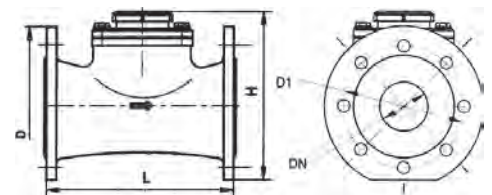

WOLTMANN

Ref. 6060A



WOLTMANN

Contador de agua tipo WOLTMANN con bridas ANSI

Para la medición del consumo de agua fría. Registro seco. Pérdida de presión mínima. Precisión de medición conforme a la Norma ISO 4064, clase de precisión 2. Posición de montaje horizontal, vertical o inclinado (se recomienda el montaje en posición horizontal y con el medidor hacia arriba). Condiciones de trabajo: Temperatura máxima del agua: 30°C. Presión máxima de trabajo: 16 bar. Extremos conexión bridas ANSI. Equipado con salida de impulsos.

WOLTMANN water meter with ANSI flanges

For measurement of high flows of cold water. Dry-dial. Low pressure loss. Measuring accuracy conform to ISO 4064 Standard, accuracy class 2. The meter can be installed in horizontal, vertical or inclined position (a horizontal position with the register face upwards is recommended). Working conditions: Maximum water temperature: 30°C. Maximum working pressure: 16 bar. ANSI flanges ends connection. Pulse output equipped.

Medida/ Size	L	H	D	D1	Agujeros/ Holes (mm)	Peso/ Weight (Kg)
2"	200	252	165	120,65	4 x 19	12
2 1/2"	200	262	185	139,7	4 x 19	13
3"	225	272	190,5	152,4	4 x 19	15
4"	250	282	228,6	190,5	8 x 19	18
5"	250	297	254	215,9	8 x 22	23
6"	300	341	279,4	241,3	8 x 22	37
8"	350	371	343	298,5	8 x 22	47
10"	450	480	406,4	362	12 x 25	94
12"	500	516	482,6	431,8	12 x 25	134

CÓDIGO CODE	MEDIDA SIZE	P.V.P. € PRICE €
6060A 09	DN 50 Bridas 2"/ DN 50 Flanges 2"	305,59
6060A 10	DN 65 Bridas 2 1/2"/ DN 65 Flanges 2 1/2"	332,76
6060A 11	DN 80 Bridas 3"/ DN 80 Flanges 3"	346,27
6060A 12	DN 100 Bridas 4"/ DN 100 Flanges 4"	431,73
6060A 13	DN 125 Bridas 5"/ DN 125 Flanges 5"	521,13
6060A 14	DN 150 Bridas 6"/ DN 150 Flanges 6"	715,14
6060A 16	DN 200 Bridas 8"/ DN 200 Flanges 8"	850,86
6060A 18	DN 250 Bridas 10"/ DN 250 Flanges 10"	1828,66
6060A 20	DN 300 Bridas 12"/ DN 300 Flanges 12"	2498,64

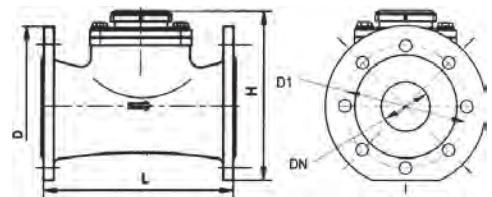

Ref. 6066



Emisor de impulsos para Woltman

Sensor de contacto libre de potencial. Cable de 2 hilos por 1,5 m de longitud.

Woltman pulse transmitter

Switch sensor potential free. 2 wire cable and 1.5 m length.

6066	23,99
------	-------

Ref. 6085



Contador de calorías

Los contadores de energía térmica de tipo compacto se utilizan para la contabilización del consumo de la energía térmica en aplicaciones de calefacción. Compuesto de unidad de cálculo de consumo energético, display de visualización de 8 dígitos, teclado de interacción usuario, contador de chorro único con la sonda de retorno insertada en el propio cuerpo del contador y sondas PT500 Ø 5 mm. Red de comunicación M-bus. Certificado MID (2004/22/CE).

Instalación del contador en la tubería de retorno. Montaje en horizontal o vertical. PN10 bar. IP54. Alimentación por batería de litio 3 V. Longitud del cable sonda 1,5 m. Rango de temperatura de fluido desde 15°C a 90°C.

Thermic energy meter

The compact thermic energy meters are used to score the thermic energy consumption in a heating installations. Components: Energetic consumption calculation unit, 8 digits display, keyboard user, single jet meter with return probe inserted into the body's meter and PT500 Ø 5 mm probes. M-bus communication net. MID (2004/22/CE) Certificate.

Meter installation on the return pipe. Horizontal or vertical mounting. PN10 bar. IP54. Lithium battery power supply. 1.5 m probe cable length. Flow temperatures range from 15°C to 90°C.

6085 05	Contador de calorías DN 15 - 3/4" / Thermic energy meter DN 15 - 3/4"	429,36
---------	---	--------

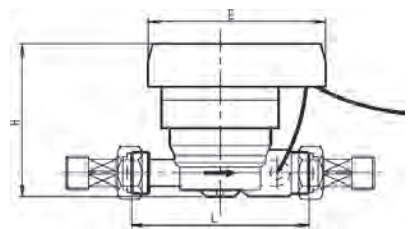

Tamaño / Size (DN)	Caudal / Flow rate			Longitud / Length L (mm)	Altura / Height H (mm)	Unidad cálculo / Compute unit E (mm)	Rosca sonda / Probe thread	Longitud sonda / Probe length (mm)
	Q max. m ³ /h	Q m ³ /h	Q min. l/h					
3/4" (15 mm)	3	1,5	7	110	95	110 (110 x 80)	M10 x 1	35

CÓDIGO CODE	MEDIDA SIZE	P.V.P. € PRICE €
----------------	----------------	---------------------

Ref. 6045

Tapa contador agua fría
Cold water meter cover

6045 00

3,69



Ref. 6040 - 6038

Racor con junta
Connector with joint



6040 04	Racor con junta / Connector with joint Racor / Connector 1/2" x 3/4"	3,33
6040 05	Racor con junta / Connector with joint Racor / Connector 3/4" x 1"	4,96
6040 06	Racor / Connector 1 1/4" x 1"	9,28
6040 07	Racor / Connector 1 1/2" x 1 1/4"	14,28
6040 08	Racor / Connector 2" x 1 1/2"	21,81
6038 04	Racor / Connector Racor / Connector 1/2" x 7/8"	5,24

Ref. 6041

Adaptador
Adaptor

6041 05

Adaptador/Adaptor 3/4" x 7/8"

1,14





CONDICIONES GENERALES DE VENTA / GENERAL SALES CONDITIONS

PRECIOS: Los precios se entienden en nuestro almacén, siendo los portes, el I.V.A. y acarreo a cargo del comprador, salvo acuerdo previo en contra.

CONDICIONES DE PAGO: En aplicación de la Ley 15/2010 que limita los plazos máximos de pago en las operaciones comerciales, hemos ajustado las condiciones a lo dispuesto en la misma. En caso de diferirse el pago, los gastos de negociación de efectos y/o los intereses legales especificados serán a cargo del comprador. El impago de cualquier efecto o recibo, conllevará la inmediata suspensión de suministros y servicios.

PEDIDOS: Para la tramitación de cualquier suministro será indispensable que el comprador nos remita el pedido por escrito indicando claramente la referencia Genebre, incluidos los dígitos de la medida y también la cantidad deseada en base a las unidades de compra mínima (por caja), tal como especifica Genebre en su catálogo. Si existen condicionantes no previstos, Genebre S.A. se reserva el derecho de aceptación o anulación de los pedidos cursados. Cada pedido solicitado a Genebre S.A. genera una expedición para el cliente con su coste de transporte correspondiente; por lo que recomendamos preparen sus pedidos completos una vez al día para optimizar el transporte. Todos los pedidos serán confirmados por Genebre, S.A. vía email/fax. Salvo notificación de lo contrario en las siguientes 24 horas, el pedido confirmado seguirá su curso sin derecho a posteriores reclamaciones.

TARIFAS DE PRECIOS: Genebre S.A. comunicará a sus clientes cualquier cambio que se produzca en las tarifas del catálogo a través de alguna de las vías de comunicación usuales (web, email, correo).

CANCELACIÓN DE PRODUCTOS DE CATÁLOGO: Genebre, S.A. comunicará a sus clientes cualquier cancelación de productos del catálogo.

ESPECIFICACIONES TÉCNICAS: El catálogo de Genebre, S.A. contiene los requisitos técnicos y normas aplicables a los productos suministrados. Genebre S.A. se reserva la facultad de cambiar en todo o en parte el diseño y materiales de cualquiera de sus productos, debido a la mejora continua de nuestros productos.

EXPEDICIONES: Todo pedido superior a 500 euros en Península se suministran a portes pagados. Para Canarias, Ceuta, Melilla y Andorra, el pedido mínimo será de 1.000 euros. Las mercancías viajan siempre por cuenta y riesgo del comprador, aún en los casos de convenios especiales.

ENTREGA: Los pedidos se suministrarán siempre por cajas completas, según especificaciones de catálogo.

RECLAMACIONES: Las eventuales reclamaciones deberán formularse dentro de los 15 días siguientes al de recepción de la mercancía por el comprador, rechazándose las efectuadas después de dicho plazo límite. NO se aceptará ninguna devolución de material sin aprobación previa de nuestro Departamento Comercial que facilitará un número de boletín de devolución que debe acompañar al material devuelto. Todas las devoluciones serán con los portes a cargo del comprador. Y se realizará un cargo por demérito del 10% del valor de la mercancía para todos los materiales, excepto para las válvulas automatizadas que será del 30%.

GARANTÍA: Queda limitada al reemplazo de las piezas reconocidas como defectuosas de fabricación por el Departamento de Calidad de Genebre S.A.. No admitiremos ninguna reclamación transcurridos 15 días de la recepción de la mercancía por el comprador.

PROPIEDAD DE LA MERCANCÍA: Genebre, S.A. se reserva el derecho de propiedad de la mercancía suministrada, hasta que el comprador no haya satisfecho totalmente el importe de la misma. En el intervalo, se considerará en concepto de depósito y custodia. La mercancía podrá ser retirada por incumplimiento de pago en el plazo previamente estipulado.

LITIGIOS: En caso de litigio, ambas partes aceptan someter sus diferencias a los Juzgados de L'Hospitalet de Llobregat.

PRICES: Prices are considered to be EX WORKS, being the freight and transportation at the cost of the purchaser, unless previous agreement has been reached.

PAYMENT TERMS: We have adjusted the conditions in application of Law 15/2010 which limits the maximum terms of payment in commercial transactions. The maximum delay on payment will be of 60 days after invoice date. Payment term will be as accorded between the parties. In case of unpaid, the expenses and interest occurred will be paid by the purchaser. The unpaid maturity will imply the complete suspension of any service or supply.

ORDERS: Regarding the handling of any supply, it is compulsory for the purchaser to send a written signed and sealed purchasing order indicating clearly Genebre's reference, including measures digits, and also the quantity required according to obligated minimum units of purchase (boxes), as Genebre's Catalogue specifies. In case of unexpected discrepancies, Genebre has the right to accept or cancel the pending orders. Each order required to Genebre, S.A., opens a client expedition with corresponding transports cost, because of that, we recommend to prepare complete orders once a day to improve the transport. All the orders will be confirmed by Genebre by e-mail/fax. Each confirmed order will be handled without any right from the purchaser to modify it, unless previous notification before 24 hours after confirmation.

PRICE LIST: Genebre will inform the customers about any change in the price list, using some usual communication way (web, e-mail or post).

PRODUCTS WITHDRAWAL FROM CATALOGUE: Genebre S.A. will inform the customers about any product withdrawal from the catalogue.

TECHNICAL SPECIFICATIONS: Genebres's catalogue holds all the technical requirements and applicable norms about the products.

SHIPMENT: Goods are shipped under the purchaser's own risk, even in special cases.

DELIVERY: Orders will always be shipped according to full boxes, as specified in the catalogue.

CLAIMS: Eventual claims must be done within 15 days after date of reception of the goods by the purchaser. Claims after such period will not be considered. NO devolution will be accepted without the previous approval from our Sales Department, who will issue a devolution certificate that must be enclosed in the devolution goods. All devolutions' freight will be paid by the purchaser. Additionally, an unworthiness debit of 10% of the products' value will be charged, except for the automatic valves that are a 30%.

GUARANTEE: It is limited to defective pieces replacement identified by Genebre's Quality Department. We will not accept any return after 15 days from the date of reception by the purchaser.

PROPERTY OF THE GOODS: Genebre has the property right of the supplied goods, until the purchaser has totally paid its value. In the meantime, it will be considered as deposit and custody. Goods shall be claimed in case of breach of payment terms.

DISPUTES: In case of disputes, both parties agree to solve discrepancies in the Barcelona Court of Justice.

GV

GV

GENEBRE

2021

LÍNEA HIDROSANITARIA

HYDROSANITARY LINE

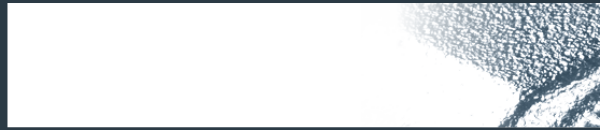

GENEBRE  **YEARS**
TOGETHER

GENEBRE GROUP Edificio Genebre • Avda. Joan Carles I, 46-48
08908 L'Hospitalet de Llobregat (Barcelona) ESPAÑA
www.genebre.es