

GENEBRE

Be water, be Genebre



LÍNEA HIDROSANITARIA

HYDROSANITARY LINE

2018



2018

Be water, be Genebre

El agua es un bien fundamental para la vida y el planeta, pero también un recurso escaso y limitado. Estamos acostumbrados a verla correr, la usamos diariamente para todo y, hasta hace poco, se creía inagotable. Sin embargo, hoy sabemos que no es así y que para su conservación en el futuro se necesita una actitud responsable diaria y una mayor conciencia ambiental de cada uno de nosotros.

Este ha sido el punto de partida del Grupo Genebre desde sus orígenes. Personas concienciadas que aplicamos esta filosofía en todos y cada uno de nuestros procesos y productos. Porque podemos soñar en un futuro más sostenible, pero para que este sueño se haga realidad debemos empezar desde nuestras propias acciones.

Water is an essential resource for life and for the planet. At the same time, water is also scarce and limited. In our minds, water is always running, and until recently, it was thought to be in endless supply. However, today we know that this is not the case. In order to save water in the future, we need to have a responsible attitude every day, as well as a greater environmental awareness.

This has been the Genebre Group's philosophy since the beginning. Genebre is made up of conscious individuals who apply this philosophy to each and every one of our processes and products. We can dream about a more sustainable future, but in order to make this dream a reality, we have to start today, with our individual actions.



Genebre



Empresa líder en válvulas y accesorios para el control de fluidos

Genebre es una empresa líder y un referente mundial en la fabricación de válvulas y accesorios para el control de fluidos y grifería de alta calidad. Controlamos todos los procesos de creación, dando respuesta a las necesidades particulares de cada mercado: desde el concepto inicial y el diseño del producto, a la producción y la comercialización. Desde su fundación en 1981 hasta nuestros días, combinamos una gran capacidad de innovación y una clara apuesta por el mercado global.

Leading company in valves and accessories for fluid control

Genebre is a leading company and world reference in fluid control and high quality taps. We control all of the creation processes, responding to the specific needs of each market: from the initial concept and design of the product to the production and commercialization. Since its founding in 1981, we have combined important innovation skills with a strong commitment to the international market.

Valor diferencial

Nuestro valor diferencial se debe a nuestra manera diferente de actuación: I+D+i, técnicas avanzadas de fabricación, disponibilidad de stock, precios competitivos, un servicio al cliente muy cuidado y, sobre todo, responsabilidad medioambiental.

Differential value

Our differential value is due to our different approach: R+D+I, advanced production techniques, stock availability, competitive prices, specialized customer service, and above all, environmental awareness.

Nos gusta lo que hacemos, y nos gusta hacerlo bien.

We like what we do, and we like to do it well

GENEBRE TIENE IMPLANTADO UN SISTEMA DE GESTIÓN DE CALIDAD PARA EL DISEÑO Y LA PRODUCCIÓN DE VÁLVULAS DE CONTROL Y REGULACIÓN DE FLUIDOS Y GRIFERÍA.

- Este sistema está certificado de acuerdo a la norma UNE-EN-ISO 9001, por parte del prestigioso organismo certificador alemán TÜV Rheinland y revisado anualmente.
- Modelo Europeo de Excelencia Empresarial (EFQM) European Foundation for Quality Management.
- ISO 14001, certificación para el Sistema de Gestión Ambiental. Este sistema está certificado siguiendo la norma UNE-EN-ISO 14001, por parte del prestigioso organismo certificador alemán TÜV Rheinland.
- UNE 166.002:2006, sistema de gestión de la I+D+i.
- Mercado CE para las válvulas industriales de acuerdo a la Directiva de Equipos a Presión 2014/68/UE con certificación externa otorgada por TÜV Rheinland.
- Homologación y Mercado N de Aenor para la línea de válvulas de gas.
- Certificados de agua potable, confirmando el cumplimiento de los criterios sanitarios de la calidad del agua para el consumo humano RD 140/2003 de 07 de febrero (legislación española) y de la directiva europea 98/83/CE del Consejo Europeo del 03 de noviembre de 1998, relativa a la calidad de las aguas destinadas al consumo humano por el Laboratorio Oliver Rodes.
- Homologación CE y otras específicas para mercados como Bielorrusia, Chile, Polonia, Rusia, Ucrania.

GENEBRE HAS IMPLEMENTED A QUALITY MANAGEMENT SYSTEM TO CONTROL THE DESIGNING AND MANUFACTURING OF FLUID CONTROL VALVES, AS WELL AS HOME AND PUBLIC TAPS.

- This system complies with the requirements of the current international UNE-EN-ISO 9001, certified by the prestigious German certification organization TÜV Rheinland and reviewed annually.
- European Foundation for Quality Management (EFQM).
- ISO 14001, certification for the Environmental Management System. This system is certified according to the UNE-EN-ISO 14001, and also by TÜV Rheinland.
- UNE 166.002:2006, R+D+i Management System.
- CE stamp for industrial valves according to the Pressure Equipment Directive 2014/68/EU with external certification by TÜV Rheinland.
- N Aenor stamp for the gas valves line.
- Water quality certification, confirming compliance with the health criteria of water quality for human consumption (RD 140/2003 7 February - Spanish legislation), and the European Directive 98/83/EC of the European Council, 3 November 1998, relating to the water quality intended for human consumption by "Laboratorios Oliver Rodes".
- EC homologation and other specific certifications for markets in Belarus, Chile, Poland, Russia and Ukraine.



Test de calidad del agua para valvulería y grifería

Water quality test for valves and taps



Nº AT/2002-02-1182 Homologación TIN Polonia



POCC ES A1077 B01804 Homologación Ghost Rusia



Around the world

**Estés donde estés,
estamos cerca de ti,
porque nuestro ámbito
de actuación es el mundo.**

Wherever you are, we are close
to you, because our field of
action is the world.

ESPAÑA / SPAIN

hidrosanitaria@genebre.es

www.genebre.es

Tel: 93 298 80 01

Fax: 93 298 80 06

INTERNACIONAL / INTERNATIONAL

exportacion@genebre.es

www.genebre.com

Europa / Europe: +34 93 298 80 15

Europa este / Eastern Europe: +34 93 298 80 19

América Latina / Latin America: +34 93 298 80 17

América del Norte / North America: +34 93 298 80 17

Fax: +34 93 298 80 08

HORARIO COMERCIAL / COMMERCIAL TIMETABLE:

8.30 h. - 13.30 h. / 15.00 h. - 18.00 h.

Viernes / Friday 8:00 h. - 16:00 H.

CORREO / MAILING ADDRESS

Edificio Genebre

Av. Joan Carles I, 46-48

Distrito económico de L'Hospitalet

L'Hospitalet de Llobregat 08908

Barcelona (Spain)

OTROS TELÉFONOS / OTHER GENERAL TELEPHONE NUMBERS

Tel. Centralita / Central telephone number: +34 93 298 80 00

Administración / Administration: +34 93 298 80 02

Fax: +34 93 298 80 07

Servicio de Atención Técnica al Cliente / Technical Support telephone number: +34 902 504 203

Genebre Argentina: www.genebre.com.ar

Genebre do Brasil: www.genebre.com.br

También nos encontrarás en / You will also find us on:



Tenemos 7 oficinas propias en 3 continentes diferentes.

Contamos con representación comercial en 22 países.

Llegamos a más de 110 países.

We have 7 offices on 3 continents.

We count on sales representatives in 22 countries.

We reach more than 110 countries.



Offices

Barcelona (Spain) / São Paulo (Brazil) / Buenos Aires (Argentina) / Mexico City (Mexico) / Ningbo (China) / Florida (Uruguay) Hong Kong (China)

La fuerte apuesta por la internacionalización, la diversificación y la innovación son las claves de nuestro crecimiento.

Strong commitment to internationalization, diversification and innovation are key to our growth.

Index

01

VÁLVULAS

VALVES

- Válvulas de esfera / Ball valves [p. 17-23](#)
- Válvulas esfera Mini / Mini ball valves [p. 24-25](#)
- Válvulas de empotrar / Built-in valves [p. 26-28](#)
- Válvulas para manguera / Bibcock valves [p. 29-33](#)
- Válvulas para barril / Barrel valves [p. 34](#)
- Válvulas escuadra / Angle valves [p. 34-37](#)
- Válvulas de retención / Check valves [p. 38-41](#)
- Válvulas de compuerta / Gate valves [p. 44-45](#)
- Filtros / Filters [p. 46-48](#)
- Válvulas reductoras de presión / Pressure reducer valves [p. 49-51](#)
- Colectores / Collectors [p. 52-53](#)
- Presostatos / Pressure Switch [p. 53-55](#)
- Controladores / Controllers [p. 55-57](#)
- Manómetros / Pressure gauges [p. 58-61](#)
- Servicios de Agua / Waterworks [p. 64-67](#)

02

CLIMATIZACIÓN

CLIMATE CONTROL

- Válvulas escuadra / Angle Valves [p. 73-78](#)
- Cabezales térmicos / Thermal heads [p. 79](#)
- Monotubo / Single-pipe [p. 80](#)
- Válvulas de seguridad / Safety valves [p. 81](#)
- Purgadores / Air vents [p. 82](#)
- Colectores / Manifolds [p. 83-84](#)
- Válvulas motorizadas / Motorised valves [p. 88-89](#)
- Termostatos / Thermostats [p. 89-92](#)
- Bombas de condensación / Condensate pumps [p. 93](#)
- Energía solar / Solar energy [p. 95-98](#)

03

VÁLVULAS DE GAS

GAS VALVES

- Válvulas rectas / Straight valves [p. 103-104](#)
- Válvulas escuadra / Square valves [p. 105](#)
- Válvulas rectas cromadas / Chrome-plated straight valves [p. 107-109](#)
- Válvulas escuadra cromadas / Chrome-plated angle valves [p. 108-109](#)

01



02



03





04

04 ELECTROVÁLVULAS SOLENOID VALVES

- Electroválvulas acción directa** / Direct acting solenoid valves **p. 115-121**
- Electroválvulas acción indirecta** / Indirect acting solenoid valves **p. 122-124**
- Electroválvulas acción mixta o combinada** / Combined acting valves **p. 125**
- Electr. acción indirecta inox** / Stainless steel indirect acting solenoid valves **p. 126-127**
- Electr. acción mixta inox** / Stainless steel mixed acting solenoid valves **p. 128**
- Electroválvulas para gas** / Gas solenoid valve **p. 128-129**
- Válvulas hidráulicas** / Hydraulic valve **p. 130-131**
- Bobinas y conectores** / Coils and connectors **p. 131-133**



05

05 ACCESORIOS DE LATÓN BRASS ACCESSORIES

- Accesorios Rac-Ge** / Rac-Ge accessories **p. 137-142**
- Otros accesorios de latón** / Other brass accessories **p. 144-148**



06

06 CONTADORES WATER METERS

- Contadores a rosca** / Threaded water meters **p. 153-154**
- Contadores a brida** / Flanged water meters **p. 155**
- Contador de calorías** / Thermic energy meters **p. 156**
- Accesorios** / Accessories **p. 156**

CONDICIONES GENERALES DE VENTA GENERAL SALES CONDITIONS

ÍNDICE POR ARTÍCULO / ARTICLE INDEX

Nº Artículo Article No.	Nº Página Page No.	Nº Artículo Article No.	Nº Página Page No.	Nº Artículo Article No.	Nº Página Page No.	Nº Artículo Article No.	Nº Página Page No.
0010	144	0063	142	3056	025	3108	034
0010	144	0550	098	3059	029	3109	034
0012	137	0565	098	3059D	029	3120	038
0012	137	0570	098	3059R	029	3121	037
0015	144	0580	098	3060	030	3121N	037
0015	144	1431S	096	3060F	030	3122P	037
0017	137	1431U	096	3061	028	3122PN	037
0017	137	1444	097	3062	028	3123	037
0020	145	1451	097	3062R	028	3124	038
0020	144	1452	097	3063	030	3124	142
0022	138	2228	087	3064	031	3131	038
0022	138	2272	048	3065	031	3134	095
0022R	138	2444	096	3066	030	3136	095
0025	145	2848	054	3066B	030	3140	038
0030	145	2850	054	3068	033	3141	037
0030	145	2918	033	3069	044	3144	096
0032	138	2919	033	3070	022	3145	039
0032	139	3017N	018	3073	087	3145N	039
0035	145	3019N	018	3075	021	3160	039
0035	145	3020	017	3080	022	3160N	039
0037	139	3020N	017	3081	024	3178	095
0037	139	3021	017	3082	024	3179	081
0040	146	3022	018	3083	026	3180	039
0040	146	3023	017	3084	021	3180N	039
0042	139	3023N	017	3085	021	3181	026
0042	140	3028	017	3088	141	3182	081
0045	146	3029	018	3088	022	3183	026
0045	146	3029H	018	3089	022	3183B	026
0047	140	3030	019	3089	141	3184	027
0047	140	3030I	019	3090	036	3184B	027
0048	147	3030N	019	3091	036	3185	040
0049	141	3032	019	3092	036	3185N	040
0050	147	3033	019	3094	033	3186	040
0050	147	3034	020	3094E	033	3187	040
0052	141	3034H	020	3095	035	3188	081
0052	140	3035	020	3095N	035	3189	081
0055	147	3036	020	3096	023	3190	040
0055	142	3037	020	3096H	023	3190N	040
0056	148	3038	020	3097	023	3191	081
0057	148	3044	024	3097H	023	3191E	081
0058	148	3046	020	3104	034	3192	081
0061	142	3048	021	3106	034	3192E	081
0062	142	3051	023	3107	034	3193	041

ÍNDICE POR ARTÍCULO / ARTICLE INDEX

Nº Artículo Article No.	Nº Página Page No.	Nº Artículo Article No.	Nº Página Page No.	Nº Artículo Article No.	Nº Página Page No.	Nº Artículo Article No.	Nº Página Page No.
3194	041	3324	048	3640	104	3882	053
3195N	035	3324R	048	3650	106	3883	053
3196N	035	3340	047	3651	106	3884	053
3211	032	3342	049	3652	106	3884	053
3215	032	3344	049	3690	105	3886	053
3217	032	3367	031	3691	105	3887	054
3220	042	3392	036	3692	105	3900	091
3221	043	3396	024	3714	059	3901	091
3221N	043	3397	024	3760	061	3905	092
3222	042	3430	063	3762	061	3906	092
3227	042	3430N	063	3770	061	3910I	050
3228	042	3434	063	3772	050	3911	089
3229	042	3438	063	3773	050	3912	090
3230	043	3442	063	3775	050	3913	090
3234	025	3446	064	3776	050	3914	090
3235	025	3450	064	3777	050	3915	090
3236	043	3451	023	3778	051	3916	089
3250	054	3454	064	3780	051	3950	060
3253	055	3462	064	3781	051	3952	060
3254	055	3490	065	3784	052	3955	060
3255	092	3491	065	3785	052	3956	060
3256	093	3499	065	3788	051	4010	125
3262	093	3500	107	3789	051	4020	122
3263	093	3505	107	3802	056	4021	124
3264	055	3510	107	3814	058	4022	122
3272E	022	3515	107	3818	056	4030	115
3282E	022	3520	108	3819	056	4030Q	115
3294	034	3525	108	3820	056	4031	115
3302	044	3550	108	3820N	057	4032	116
3302N	044	3555	108	3821	057	4040	119
3304	044	3560	109	3822	058	4041	119
3310	045	3565	109	3822N	058	4050	122
3311	045	3570N	109	3824	059	4100	125
3312	110	3575	109	3824N	059	4110	128
3312	045	3600	105	3825	057	4112	128
3313	046	3610	103	3826	057	4115	128
3314	046	3615	103	3827	059	4118	129
3316	046	3620	103	3829	058	4120	129
3317	045	3622	103	3850	039	4122	129
3318	047	3625	103	3860	041	4210	116
3318N	047	3627	104	3865	041	4220	116
3320	047	3630	104	3880	052	4221	117
3320E	047	3632	104	3881	052	4222	117

ÍNDICE POR ARTÍCULO / ARTICLE INDEX

Nº Artículo Article No.	Nº Página Page No.	Nº Artículo Article No.	Nº Página Page No.	Nº Artículo Article No.	Nº Página Page No.	Nº Artículo Article No.	Nº Página Page No.
4223RC	117	6010	153	70153	077	K3052	028
4232	118	6011	153	70154	073	K4000	133
4240	119	6015	153	70154	077	M3054	027
4250	118	6020	153	70154	075	M3055	027
4320	120	6021	153	70171	084	M3057	028
4321	120	6029	154	70176	084	R360	032
4322	120	6029P	154	70177	080		
4324	120	6038	156	70300	110		
4328	120	6040	156	70306	079		
4330	121	6041	156	70500	093		
4332	121	6045	156	70564	078		
4333	123	6060	155	70564	076		
4335	121	6060A	155	70564	074		
4336	121	6066	155	70565	076		
4340	119	6085	156	70565	074		
4425	123	6090	154	70565	078		
4426	124	6110C	153	70585	079		
4440	118	6111C	153	70587	074		
4519	125	6120C	153	70587	076		
4630	126	6121C	153	70588	074		
4631	126	6192	154	70588	076		
4632	127	70017	082	70590	079		
4633	127	70018	082	70621	086		
4635	128	70024	083	70874	085		
4710	130	70031	077	71012	082		
4711	130	70032	077	71028	080		
4720	130	70035	083	72190 06	085		
4721	130	70037	083	72501	079		
4730	131	70037	095	72606	084		
4731	131	70037	082	72961	086		
4790	088	70038	083	73070	087		
4791	088	70041	080	73153	082		
4792	089	70042	084	73262	092		
4793	089	70048	078	73286	088		
4801	132	70049	078	73566	086		
4801	133	70069	084	75404	080		
4803	133	70070	081	78454	085		
4804	132	70071	080	79320	086		
4805	131	70151	075	8031	090		
4808	131	70151	073	8045	091		
4814	132	70152	073	8046	091		
4819	132	70152	075	8047	091		
4828	132	70153	073	8048	091		
4974	131	70153	075	K3000	025		



2018





VÁLVULAS VALVES

**Una gama completa de válvulas de latón,
esfera manguera, retención, compuerta, filtros,
manómetros, ... para todo tipo de instalaciones.**

A complete range of brass ball valves, bibcock ball valves, retention valves, gate valves, strainers, pressure gauges, ... for all types of installations.



Ref. 3020 - 3020N



Válvula de esfera serie pesada

También disponible con rosca NPT (3020N).
PN 40. Paso total. Construcción en latón UNE-EN 12165 cromado. Asientos PTFE. Extremos rosca gas (BSP) H-H - ISO 228/1. Temp. máx. 110°C. Mando manual por palanca de acero.

Heavy ball valve

Also available NPT thread (3020N).
PN 40. Full bore. Body chrome plated brass UNE-EN 12165. PTFE seats. Gas threaded ends (BSP) F-F - ISO 228/1. Max. Temp. 110°C. Steel lever manual control.

R	P	A	L	M
1/4"	10	45	48	84
3/8"	10	45	50	84
1/2"	15	47	58	84
3/4"	20	58	65	98
1"	25	61	78	98
1 1/4"	32	74	88	126
1 1/2"	40	80	105	126
2"	50	91	122	158

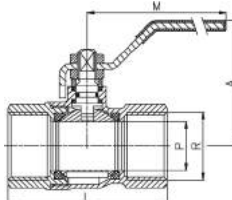

CÓDIGO CODE	MEDIDA SIZE	PESO WEIGHT	CAJA / BOX CARTON	P.V.P. € PRICE €
3020 02	1/4"	0,130	8-192	-
3020 03	3/8"	0,128	8-192	-
3020 04	1/2"	0,174	8-144	-
3020 05	3/4"	0,288	8-96	-
3020 06	1"	0,432	6-72	-
3020 07	1 1/4"	0,706	4-48	-
3020 08	1 1/2"	1,027	2-24	-
3020 09	2"	1,590	2-18	-

Precios rosca NPT a consultar. / NPT thread prices on request.

Ref. 3021



Válvula de esfera serie pesada

PN 40. Paso total. Construcción en latón UNE-EN 12165 cromado. Asientos PTFE. Extremos rosca gas (BSP) H-H - ISO 228/1. Temp. máx. 110°C. Mando manual por palanca de acero inoxidable.

Heavy ball valve

PN 40. Full bore. Body chrome plated brass UNE-EN 12165. PTFE seats. Gas threaded ends (BSP) F-F - ISO 228/1. Max. Temp. 110°C. Stainless steel lever manual control.

R	P	A	L	M
1/4"	10	45	48	84
3/8"	10	45	50	84
1/2"	15	47	58	84
3/4"	20	58	65	98
1"	25	61	78	98
1 1/4"	32	74	88	126
1 1/2"	40	80	105	126
2"	50	91	122	158

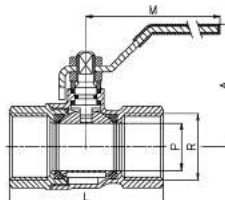

CÓDIGO CODE	MEDIDA SIZE	PESO WEIGHT	CAJA / BOX CARTON	P.V.P. € PRICE €
3021 02	1/4"	0,150	8-192	-
3021 03	3/8"	0,129	8-192	-
3021 04	1/2"	0,178	8-144	-
3021 05	3/4"	0,285	8-96	-
3021 06	1"	0,430	6-72	-
3021 07	1 1/4"	0,688	4-48	-
3021 08	1 1/2"	1,001	2-24	-
3021 09	2"	1,575	2-18	-

Ref. 3023 - 3023N



Válvula de esfera para montaje actuador

También disponible con rosca NPT (3023N).
PN 40. Paso total. Construcción en latón UNE-EN 12165 cromado. Asientos PTFE. Extremos rosca gas (BSP) H-H ISO 228/1. Temp. máx. 110°C. Conexión a actuador s/ ISO 5211. Palanca en acero.

Ball valve for direct assembling

Also available NPT thread (3023N).
PN 40. Full bore. Body chrome plated brass UNE-EN 12165 cromado. PTFE seats. Gas threaded ends (BSP) F-F ISO 228/1. Max. temp. 110°C. Actuator connection ISO 5211. Steel lever handle.

R	P	A	M	L	X	H	E	Q	ISO5211
1/2"	15	52	104	58	15	27	11	9	F03
3/4"	20	57	104	65	16	32	11	9	F03
1"	25	60	112	78	20	35	11	9	F04
1 1/4"	32	69	139	88	20	44	14	11	F05
1 1/2"	40	75	139	105	25	49	14	11	F05
2"	50	86	139	122	27	60	14	11	F05

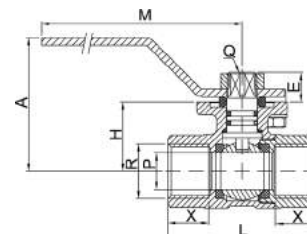

CÓDIGO CODE	MEDIDA SIZE	PESO WEIGHT	CAJA / BOX CARTON	P.V.P. € PRICE €
3023 04	1/2"	0,265	10-80	-
3023 05	3/4"	0,334	6-60	-
3023 06	1"	0,572	4-48	-
3023 07	1 1/4"	0,890	5-30	-
3023 08	1 1/2"	1,425	4-24	-
3023 09	2"	2,375	2-12	-

Precios rosca NPT a consultar. / NPT thread prices on request.

Ref. 3028



Válvula esfera serie ligera

PN 25. Paso estándar. Construcción en latón UNE-EN 12165 cromado. Asientos PTFE. Extremos rosca gas (BSP) H-H - ISO 228/1. Temp. máx. 110°C. Mando manual por palanca de acero.

Light ball valve

PN 25. Standard bore. Body chrome plated brass UNE-EN 12165. PTFE seats. Gas threaded ends (BSP) F-F - ISO 228/1. Max. Temp. 110°C. Steel lever manual control.

R	P	A	L	M
1/2"	14	46	44	84
3/4"	18	50	51	84
1"	23	57	61	92
1 1/4"	27	63	71	98
1 1/2"	34	74	81	113
2"	43	83	93	126
2 1/2"	52	96	118	158
3"	65	126	137	196
4"	79	137	163	265

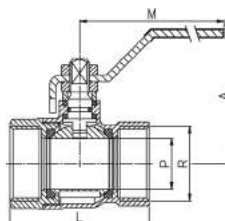

CÓDIGO CODE	MEDIDA SIZE	PESO WEIGHT	CAJA / BOX CARTON	P.V.P. € PRICE €
3028 04	1/2"	0,133	8-192	-
3028 05	3/4"	0,215	8-128	-
3028 06	1"	0,328	8-96	-
3028 07	1 1/4"	0,420	6-72	-
3028 08	1 1/2"	0,754	2-24	-
3028 09	2"	1,030	2-24	-
3028 10	2 1/2"	1,906	6-12	-
3028 11	3"	2,987	4-8	-
3028 12	4"	4,882	2-4	-

Ref. 3029 - 3022



Válvula de esfera

También disponible con rosca NPT (3022).
PN 25. Paso total. Construcción en latón UNE-EN 12165 cromado. Asiento PTFE. Extremos roscados H-H - ISO 228/1. Temp. máx. 110°C. Mando manual por palanca de acero.

Ball valve

Also available NPT thread (3022).
PN 25. Full bore. Body chrome plated brass UNE-EN 12165. PTFE seats. Treaded ends F-F - ISO 228/1. Max. temp. 110°C. Steel lever manual control.

R	P	A	L	M
1/4"	10	46	40	84
3/8"	10	46	43	84
1/2"	15	47	49	84
3/4"	20	58	56	98
1"	25	61	68	98
1 1/4"	32	74	80	126
1 1/2"	40	80	89	126
2"	50	91	104	158
2 1/2"	59	101	137	158
3"	72	131	158	196
4"	90	145	183	265

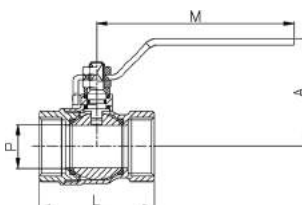

CÓDIGO CODE	MEDIDA SIZE	PESO WEIGHT	CAJA / BOX CARTON	P.V.P. € PRICE €
3029 02	1/4"	0,106	10-240	-
3029 03	3/8"	0,113	10-240	-
3029 04	1/2"	0,151	8-192	-
3029 05	3/4"	0,254	8-96	-
3029 06	1"	0,410	6-72	-
3029 07	1 1/4"	0,611	4-48	-
3029 08	1 1/2"	0,833	2-24	-
3029 09	2"	1,333	2-18	-
3029 10	2 1/2"	2,431	4-8	-
3029 11	3"	4,048	2-4	-
3029 12	4"	6,350	1-2	-

Precios rosca NPT a consultar / NPT thread prices on request

Ref. 3029H



Válvula de esfera (palanca roja)

PN 25. Paso total. Construcción en latón UNE-EN 12165 cromado. Asiento PTFE. Extremos roscados H-H - ISO 228/1. Temp. máx. 110°C. Mando manual por palanca de acero.

Ball valve (red handle)

PN 25. Full bore. Body chrome plated brass UNE-EN 12165. PTFE seats. Threaded ends F-F - ISO 228/1. Max. temp. 110°C. Steel lever manual control.

R	P	A	L	M
1/2"	15	47	49	84
3/4"	20	58	56	98
1"	25	61	68	98

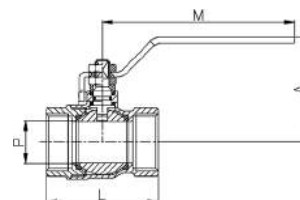

3029H 04	1/2"	0,150	8-192	-
3029H 05	3/4"	0,250	8-96	-
3029H 06	1"	0,380	6-72	-

Ref. 3017N



Válvula de esfera

400-WOG. Paso total. Construcción en latón UNE-EN 12165. Asientos PTFE. Extremos rosca NPT - H-H. Temperatura máx. 110°C. Mando manual por palanca de acero.

Ball valve

400 WOG. Full bore. Brass construction UNE-EN 12165. PTFE seats. NPT threaded ends - F-F. Max. temperature 110°C. Steel lever manual control.

R	P	A	L	M
1/2"	15	47	49	84
3/4"	20	58	56	98
1"	25	61	68	98
1 1/4"	32	74	80	126
1 1/2"	40	80	89	126
2"	50	91	104	158
2 1/2"	59	101	137	158
3"	72	131	158	196
4"	90	145	183	265

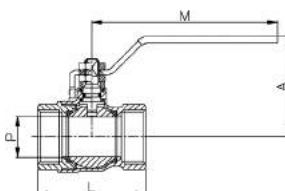

3017N 04	1/2"	0,160	8-144	-
3017N 05	3/4"	0,270	8-96	-
3017N 06	1"	0,395	6-72	-
3017N 07	1 1/4"	0,620	4-48	-
3017N 08	1 1/2"	0,865	2-24	-
3017N 09	2"	1,365	2-18	-
3017N 10	2 1/2"	2,490	4-8	-
3017N 11	3"	4,125	2-4	-
3017N 12	4"	6,300	1-2	-

Ref. 3019N

NEW



Válvula de esfera (palanca amarilla)

PN 40. Paso total. Construcción en latón UNE-EN 12165. Asientos PTFE. Extremos roscados NPT - H-H. Temp. máx. 110°C. Mando manual por palanca de acero.

Ball valve (yellow handle)

PN 40. Full bore. Brass construction UNE-EN 12165. PTFE seats. Threaded ends NPT - F-F. Max. temp. 110°C. Steel lever manual control.

R	P	A	L	M
1/4"	10	45	48	84
3/8"	10	45	50	84
1/2"	15	47	58	84
3/4"	20	58	65	98
1"	25	61	78	98
1 1/4"	32	74	88	126
1 1/2"	40	80	105	126
2"	50	91	122	126

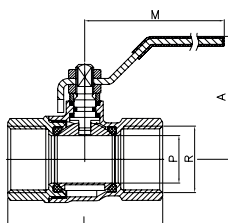

3019N 02	1/4"	0,130	8-192	-
3019N 03	3/8"	0,128	8-192	-
3019N 04	1/2"	0,180	8-144	-
3019N 05	3/4"	0,300	8-96	-
3019N 06	1"	0,442	6-72	-
3019N 07	1 1/4"	0,701	4-48	-
3019N 08	1 1/2"	1,031	2-24	-
3019N 09	2"	1,581	2-18	-

Ref. 3030 - 3030N



Válvula esfera

También disponible con rosca NPT (3030N).
PN 25. Paso total. Construcción en latón UNE-EN 12165 cromado. Asientos PTFE. Eje con doble o'ring EPDM. Extremos roscados H-H ISO 228/1. Temp. máx. 150°C. Mando manual por palanca de acero.

Ball valve

Also available NPT thread (3030N)
PN 25. Full bore. Body chrome plated brass UNE-EN 12165. PTFE seats. Steam with double EPDM o'ring. Threaded ends F-F ISO 228/1. Max. temp. 150°C. Steel lever manual control.

R	P	A	L	M
1/2"	15	45	49	84
3/4"	20	53	56	93
1"	25	56	70	93
1 1/4"	32	68	79	115
1 1/2"	40	77	89	126
2"	50	86	104	158

CÓDIGO CODE	MEDIDA SIZE	PESO WEIGHT	CAJA / BOX CARTON	P.V.P. € PRICE €
3030 04	1/2"	0,149	8-192	-
3030 05	3/4"	0,244	8-96	-
3030 06	1"	0,374	6-72	-
3030 07	1 1/4"	0,589	4-48	-
3030 08	1 1/2"	0,855	2-24	-
3030 09	2"	1,349	2-18	-

Precios rosca NPT a consultar / NPT thread prices on request

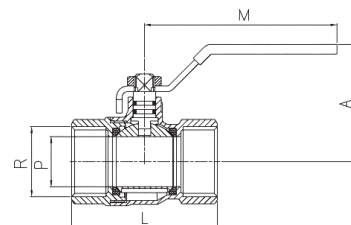

Ref. 3030I



Válvula de esfera

PN 25. Paso total. Construcción en latón UNE-EN 12165 niquelado. Asientos PTFE. Eje con doble o-ring. Extremos roscados ISO 228/1 - H-H. Temp. máx. 110°C. Mando manual por palanca de acero inoxidable.

Ball valve

PN 25. Full bore. Body nickel plated brass UNE-EN 12165. PTFE seats. Stem with double o-ring. Threaded ends ISO 228/1 - F-F. Max. temp. 110°C. Stainless Steel lever manual control.

R	P	A	L	M
1/2"	15	45	49	84
3/4"	20	53	56	93
1"	25	56	70	93
1 1/4"	32	66	79	115
1 1/2"	40	77	89	126
2"	50	86	104	158

3030I 04	1/2"	0,149	8-192	-
3030I 05	3/4"	0,244	8-96	-
3030I 06	1"	0,374	6-72	-
3030I 07	1 1/4"	0,589	4-48	-
3030I 08	1 1/2"	0,855	2-24	-
3030I 09	2"	1,349	2-18	-

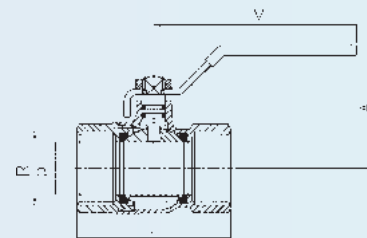

Ref. 3032



Válvula de esfera con tomas laterales

PN 25. Paso total. Construcción en latón UNE-EN 12165 cromado. Asientos PTFE. Extremos rosca gas (BSP) H-H - ISO 228/1. Temp. máx. 110°C. Mando manual por palanca acero. 2 tomas laterales 1/4" - 1 de ellas con tapón.

Ball valve with side inlets

PN 25. Full bore. Body chrome plated brass UNE-EN 12165. PTFE seats. Gas threaded ends (BSP) F-F - ISO 228/1. Max. temp. 110°C. Steel lever manual control. Two-sided 1/4" inlet - plug on one side.

R	P	A	L	M
1/2"	15	47	52	84
3/4"	20	58	60	98
1"	25	61	72	98

3032 04	1/2"	0,180	10-100	-
3032 05	3/4"	0,311	8-80	-
3032 06	1"	0,420	5-50	-

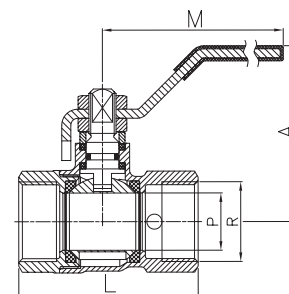

Ref. 3033



Válvula de esfera

PN 25. Paso total. Construcción en latón UNE-EN 12165 cromado. Asientos PTFE. Extremos rosca gas (BSP) M-M - ISO 228/1. Temp. máx. 110°C. Mando manual por palanca acero.

Ball valve

PN 25. Full bore. Body chrome plated brass UNE-EN 12165. PTFE seats. Gas threaded ends (BSP) M-M - ISO 228/1. Max. Temp. 110°C. Steel lever manual control.

R	P	A	L	M
1/2"	15	47	56	84
3/4"	20	58	65	98
1"	25	61	78	98

3033 04	1/2"	0,273	10-140	-
3033 05	3/4"	0,273	8-64	-
3033 06	1"	0,400	6-48	-

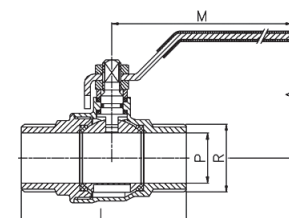

Ref. 3034 - 3034H



Válvula de esfera (3034 palanca azul - 3034H palanca roja)
 PN 25. Paso total. Construcción en latón UNE-EN 12165 cromado. Asientos PTFE. Extremos rosca gas (BSP) M-H ISO 228/1. Temp. máx. 110°C. Mando manual por palanca de acero.

Ball valve (3034 blue handle - 3034H red handle)
 PN 25. Full bore. Body chrome plated brass UNE-EN 12165. PTFE seats. Gas threaded ends (BSP) M-F ISO 228/1. Max. temp. 110°C. Steel lever manual control.

R	P	A	L	M
1/4"	10	46	48	84
3/8"	10	46	49	84
1/2"	15	47	55	84
3/4"	20	58	64	98
1"	25	61	76	98
1 1/4"	32	74	87	126
1 1/2"	40	80	95	126
2"	50	91	109	158

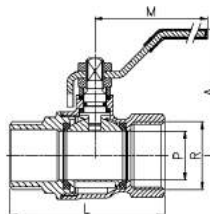

CÓDIGO CODE	MEDIDA SIZE	PESO WEIGHT	CAJA / BOX CARTON	P.V.P. € PRICE €
3034 02	1/4"	0,115	10-240	-
3034 03	3/8"	0,114	10-240	-
3034 04	1/2"	0,192	8-192	-
3034 05	3/4"	0,291	6-108	-
3034 06	1"	0,406	6-72	-
3034 07	1 1/4"	0,637	4-48	-
3034 08	1 1/2"	0,912	2-24	-
3034 09	2"	1,334	2-18	-
3034H 04	1/2"	0,170	8-192	-
3034H 05	3/4"	0,275	6-108	-
3034H 06	1"	0,410	6-72	-

Ref. 3035 - 3037



Válvula de esfera (3035 palomilla azul - 3037 palomilla roja)
 PN 25. Paso total. Construcción en latón UNE-EN 12165 cromado. Asiento PTFE. Extremos rosca gas (BSP) H-H. ISO 228/1. Temp. máx. 110°C. Mando manual por palomilla aluminio.

Ball valve (3035 blue butterfly handle - 3037 red butterfly handle)
 PN 25. Full bore. Body chrome plated brass UNE-EN 12165. PTFE seats. Gas threaded ends (BSP) F-F - ISO 228/1. Max. temp. 110°C. Aluminium butterfly handle.

R	P	A	L	M
1/4"	10	38	40	50
3/8"	10	38	43	50
1/2"	15	40	49	50
3/4"	20	50	56	62
1"	25	53	68	62

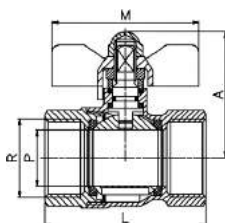

CÓDIGO CODE	MEDIDA SIZE	PESO WEIGHT	CAJA / BOX CARTON	P.V.P. € PRICE €
3035 02	1/4"	0,125	12-288	-
3035 03	3/8"	0,093	12-288	-
3035 04	1/2"	0,140	10-240	-
3035 05	3/4"	0,251	6-108	-
3035 06	1"	0,357	5-90	-
3037 02	1/4"	0,125	12-288	-
3037 03	3/8"	0,100	12-288	-
3037 04	1/2"	0,129	10-240	-
3037 05	3/4"	0,218	6-108	-
3037 06	1"	0,348	5-90	-

Ref. 3036 - 3038

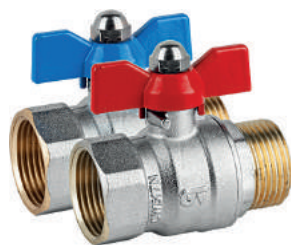

Válvula de esfera (3036 palomilla azul - 3038 palomilla roja)
 PN 25. Paso total. Construcción en latón UNE-EN 12165 cromado. Asientos PTFE. Extremos rosca gas (BSP) M-H - ISO 228/1. Temp. máx. 110°C. Mando manual por palomilla aluminio.

Ball valve (3036 blue butterfly handle - 3038 red butterfly handle)
 PN 25. Full bore. Body chrome plated brass UNE-EN 12165. PTFE seats. Gas threaded ends M-F (BSP) - ISO 228/1. Max. temp. 110°C. Aluminium butterfly handle.

R	P	A	L	M
1/4"	10	38	48	50
3/8"	10	38	49	50
1/2"	15	40	56	50
3/4"	20	50	64	62
1"	25	53	76	62
1/4"	10	38	40	50
3/8"	10	38	43	50
1/2"	15	40	49	50
3/4"	20	50	56	62
1"	25	53	68	62

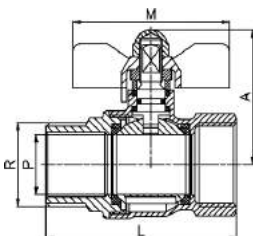

CÓDIGO CODE	MEDIDA SIZE	PESO WEIGHT	CAJA / BOX CARTON	P.V.P. € PRICE €
3036 02	1/4"	0,093	12-288	-
3036 03	3/8"	0,104	12-288	-
3036 04	1/2"	0,146	10-240	-
3036 05	3/4"	0,262	6-108	-
3036 06	1"	0,360	5-90	-
3038 02	1/4"	0,125	12-288	-
3038 03	3/8"	0,100	12-288	-
3038 04	1/2"	0,129	10-240	-
3038 05	3/4"	0,218	6-108	-
3038 06	1"	0,348	5-90	-

Ref. 3046



Válvula de esfera con racor dos piezas
 PN 25. Paso total. Construcción en latón UNE-EN 12165 cromado. Asientos PTFE. Extremos rosca gas (BSP) M-H ISO 228/1. Temp. máx. 110°C. Mando manual por palomilla aluminio.

Ball valve with 2 pieces connector
 PN 25. Full bore. Body chrome plated brass UNE-EN 12165. PTFE seats. Gas threaded ends (BSP) M-F - ISO 228/1. Max. Temp. 110°C. Aluminium butterfly handle for manual control.

R	P	A	L	M
1/2"	15	36	69	50
3/4"	20	44	76	62
1"	25	48	92	62
1 1/4"	30	57	106	78

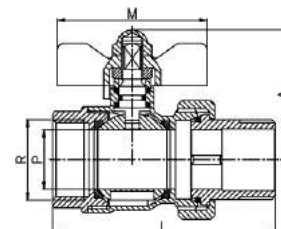

CÓDIGO CODE	MEDIDA SIZE	PESO WEIGHT	CAJA / BOX CARTON	P.V.P. € PRICE €
3046 04	1/2"	0,170	18-144	-
3046 05	3/4"	0,320	10-80	-
3046 06	1"	0,500	6-48	-
3046 07	1 1/4"	0,730	4-32	-

Ref. 3048



Válvula de esfera con racor dos piezas
 PN 25. Paso total. Construcción en latón UNE-EN 12165 cromado. Asientos PTFE. Extremos rosca gas (BSP) M-H - ISO 228/1. Temp. máx. 110°C. Mando manual por palanca de acero.

Ball valve with 2 pieces connector
 PN 25. Full bore. Body chrome plated brass UNE-EN 12165. PTFE seats. Gas threaded ends (BSP) M-F - ISO 228/1. Max. Temp. 110°C. Steel lever manual control.

R	DN	A	L	M
1/2"	15	47	69	84
3/4"	20	58	76	98
1"	25	61	92	98
1 1/4"	32	74	106	126
1 1/2"	40	80	119	126
2"	50	91	141	158

CÓDIGO CODE	MEDIDA SIZE	PESO WEIGHT	CAJA / BOX CARTON	P.V.P. € PRICE €
3048 04	1/2"	0,203	8-192	-
3048 05	3/4"	0,340	6-72	-
3048 06	1"	0,523	4-48	-
3048 07	1 1/4"	0,787	2-24	-
3048 08	1 1/2"	1,144	2-24	-
3048 09	2"	1,712	2-18	-

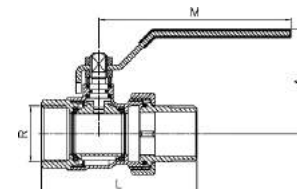

Ref. 3075



Válvula de esfera escuadra M-H con racor dos piezas
 PN 25. Paso total. Construcción en latón UNE-EN 12165 cromado. Asientos PTFE. Extremos rosca gas (BSP) M-H - ISO 228/1. Temp. máx. 110°C. Mando manual por palomilla aluminio.

Ball angle valve M-F with 2 pieces detachable connector
 PN 25. Full bore. Body chrome plated brass UNE-EN 12165. PTFE seats. Gas threaded end (BSP) M-F - ISO 228/1. Max. Temp. 110°C. Aluminium butterfly handle.

R	P	A	L	M
3/4"	20	87	58	62
1"	25	97	63	62

3075 05	3/4"	0,350	8-48	-
3075 06	1"	0,549	5-30	-

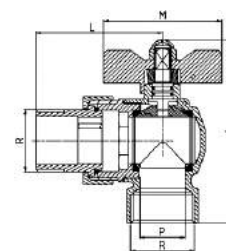

Ref. 3084



Válvula de esfera mando cuadradillo
 PN 25. Paso total. Construcción en latón UNE-EN 12165 cromado. Asientos PTFE. Extremos rosca gas (BSP) H-H - ISO 228/1. Temp. máx. 110°C. Accionamiento mediante cuadradillo.

Square handle ball valve
 PN 25. Full bore. Body chrome plated brass UNE-EN 12165. PTFE seats. Gas threaded ends (BSP) F-F - ISO 228/1. Max. temp. 110°C. Square handle.

R	P	A	L	M
1/2"	15	38	49	20
3/4"	20	49	56	20
1"	25	52	68	20
1 1/4"	32	63	80	30
1 1/2"	40	69	89	30
2"	50	80	104	30
2 1/2"	60	89	137	30
3"	74	117	158	30
4"	92	131	183	30

3084 04	1/2"	0,154	15-210	-
3084 05	3/4"	0,245	10-140	-
3084 06	1"	0,380	8-80	-
3084 07	1 1/4"	0,587	5-40	-
3084 08	1 1/2"	0,830	2-16	-
3084 09	2"	1,300	2-16	-
3084 10	2 1/2"	2,365	1-8	-
3084 11	3"	3,950	1-4	-
3084 12	4"	5,720	1-2	-

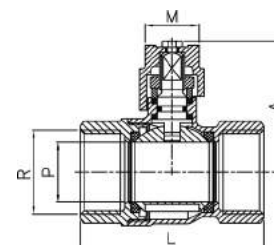

Ref. 3085



Válvula de esfera mando cuadradillo
 PN 25. Paso total. Construcción en latón UNE-EN 12165 cromado. Asientos PTFE. Extremos rosca gas (BSP) M-H - ISO 228/1. Temp. máx. 110°C. Accionamiento mediante cuadradillo.

Square handle ball valve
 PN 25. Full bore. Body chrome plated brass UNE-EN 12165. PTFE seats. Gas threaded ends (BSP) M-F - ISO 228/1. Max. temp. 110°C. Square handle.

R	P	A	L	M
1/2"	15	38	55	20
3/4"	20	49	64	20
1"	25	52	76	20
1 1/4"	32	63	87	30
1 1/2"	40	69	89	30
2"	50	80	109	30

3085 04	1/2"	0,160	10-180	-
3085 05	3/4"	0,260	6-108	-
3085 06	1"	0,395	6-72	-
3085 07	1 1/4"	0,630	5-40	-
3085 08	1 1/2"	0,154	2-20	-
3085 09	2"	1,300	2-16	-

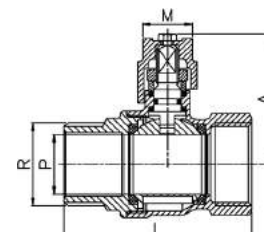

Ref. 3088



Válvula de esfera tubería PE
 PN 25. Paso total. Construcción en latón s/UNE-EN 12165. Asientos PTFE. Extremos conexión a tubería mediante sistema de apriete diseño Genebre "RAC-GE". Temperatura de trabajo de -20°C a +110°C. Aplicable para la unión de tubo de polietileno de baja-media y alta densidad. Mando manual por palanca de acero.

Ball valve for PE pipe
 PN 25. Full bore. Brass construction UNE-EN 12165. PTFE seats. Genebre's designed "RAC-GE" air tight system ends for connection to pipe. Working temp.: -20 °C to 110 °C. Applicable for the connection of low-medium and high density polyethylene pipe. Steel lever manual control.

DN	Ø PE	P	A	L	M
15	20	14	47	77	84
20	25	19	58	91	98
25	32	24	61	109	98

CÓDIGO CODE	MEDIDA SIZE	PESO WEIGHT	CAJA / BOX CARTON	P.V.P. € PRICE €
-------------	-------------	-------------	-------------------	------------------

3088 04	20 x 20	0,240	6-108	-
3088 05	25 x 25	0,378	6-72	-
3088 06	32 x 32	0,574	3-36	-

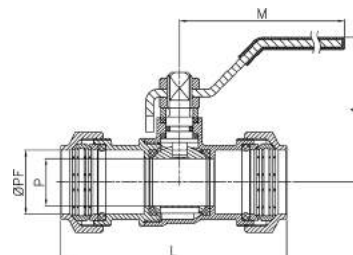

Ref. 3089



Válvula de esfera tubería PE
 PN 25. Paso total. Construcción en latón s/UNE-EN 12165. Extremos roscado gas hembra s/ISO 228/1. Asiento PTFE. Conexión a tubería mediante sistema de apriete diseño Genebre "RAC-GE". Temperatura de trabajo de -20°C a + 110°C. Aplicable para la unión de tubo de polietileno de baja-media y alta densidad. Mando manual por palanca de acero.

Ball valve for PE pipe
 PN 25. Full bore. Brass UNE-EN 12165. Female gas threaded ends ISO 228/1. PTFE Seats. Genebre's designed "RAC-GE" air tight system for connection to pipe. Working temp.: -20 °C to 110 °C. Applicable for the connection of low-medium and high density polyethylene pipe. Steel lever manual control.

DN	Ø PE	P	A	L	M
15	20	14	47	61	84
20	25	19	58	71	98
25	32	24	61	86	98

3089 04	1/2" x 20	0,195	8-144	-
3089 05	3/4" x 25	0,333	6-72	-
3089 06	1" x 32	0,497	4-48	-

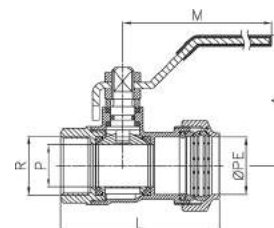

Ref. 3272E - 3282E



Válvula de esfera 3 vías para montaje actuador tipo "L" (3272E) y tipo "T" (3282E)

PN 25. Paso total. Construcción en latón niquelado UNE-EN 12165. Asientos PTFE. Extremos rosca gas (BSP) H ISO 228/1. Obturador esférico en 2/3 vías en forma "L" / "T". Juntas tóricas EPDM. Temp. máx. 150°C. Mando manual por palanca. Conexión a actuador s/ISO 5211.

3 ways ball valve for direct assembling type "L" (3272E) and type "T" (3282E)

PN 25. Full bore. Body nickel plated brass UNE-EN 12165. PTFE seats. Gas threaded ends (BSP) F ISO 228/1. 2/3 ways spherical seal type "L" / "T". EPDM o-rings. Max. temp. 150°C. Steel lever manual control. Direct assembling ISO 5211.

R	P	A	B	L	M	□Q	ISO 5211
1/2"	15	58	33	74	104	□9	F03
3/4"	20	63	38	85	111	□9	F04
1"	25	68	43	97	111	□9	F04

ART.	TIPO	PASO	1	2	3	4
3272E	L	1	2	3	1	2
3282E	T	1	2	3	1	2

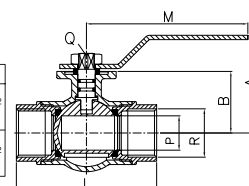

3272E 04	1/2"	0,443	4-60	-
3272E 05	3/4"	0,682	2-30	-
3272E 06	1"	1,012	2-24	-

3282E 04	1/2"	0,440	4-60	-
3282E 05	3/4"	0,675	2-30	-
3282E 06	1"	1,000	2-24	-

Ref. 3070 - 3080



Válvula esfera 3 vías tipo "L" (3070) y Tipo "T" (3080)

PN 25. Construcción en latón UNE-EN 12165 cromado. Asientos de PTFE. Extremos rosca gas (BSP) H - ISO 228/1. Obturador esférico en dos/tres vías en forma "L" / "T". Temp. máx. 120°C. Mando manual por palanca.

Type "L" (3070) and Type "T" (3080) 3 way ball valve

PN 25. Chrome plated brass UNE-EN 12165 body. 4 PTFE seats. Gas threaded ends (BSP) F - ISO 228/1. Spherical seal 2/3 way type "L" / "T". Max. Temp. 120°C. Manual control lever.

R	P	A	L	M
1 1/4"	29	100	118	170
1 1/2"	36	120	138	170
2"	45	130	162	260

ART.	TIPO	PASO	1	2	3	4
3070	L	1	2	3	1	2
3080	T	1	2	3	1	2

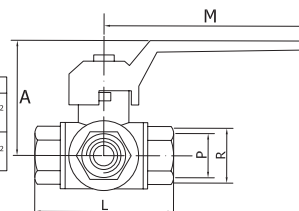

3070 07	1 1/4"	2,250	2-16	-
3070 08	1 1/2"	3,640	2-6	-
3070 09	2"	5,700	2-4	-

3080 07	1 1/4"	2,242	2-16	-
3080 08	1 1/2"	3,630	2-6	-
3080 09	2"	5,690	2-4	-

Ref. 3096 - 3096H



Válvula esfera mini (3096 palanca azul - 3096H palanca roja)
 PN 16. Paso reducido. Construcción en latón cromado UNE-EN 12165 . Asientos PTFE. Extremos rosca gas (BSP) H-H según ISO 228/1. Temp. máx. 110°C. Mando palomilla aluminio.

Mini ball valve (3096 blue handle - 3096H red handle)
 PN 16. Reduced bore. Body chrome plated brass UNE-EN 12165. PTFE seats. Gas threaded ends (BSP) F-F ISO 228/1. Max. temp. 110°C. Butterfly handle operated aluminium

R	P	A	L	M
1/8"	6,5	28	37	22
1/4"	6,5	28	39	22
3/8"	8	30	42	22
1/2"	10	33	46	22
3/4"	12,5	36	55	22

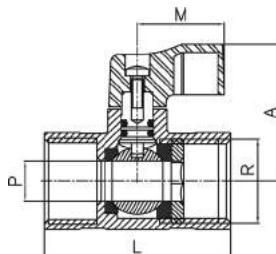

CÓDIGO CODE	MEDIDA SIZE	PESO WEIGHT	CAJA / BOX CARTON	P.V.P. € PRICE €
3096 01	1/8"	0,090	20-480	-
3096 02	1/4"	0,052	20-480	-
3096 03	3/8"	0,085	15-360	-
3096 04	1/2"	0,130	10-240	-
3096 05	3/4"	0,185	8-192	-
3096H 01	1/8"	0,090	20-480	-
3096H 02	1/4"	0,052	20-480	-
3096H 03	3/8"	0,085	15-360	-
3096H 04	1/2"	0,130	10-240	-
3096H 05	3/4"	0,185	8-192	-

Ref. 3097 - 3097H



Válvula esfera mini (3097 palanca azul - 3097H palanca roja)
 PN 16. Paso reducido. Construcción en latón cromado UNE-EN 12165 . Asientos PTFE. Extremos rosca gas (BSP) M-H según ISO 228/1. Temp. máx. 110°C. Mando palomilla aluminio.

Mini ball valve (3097 blue handle - 3097H red handle)
 PN 16. Reduced bore. Body chrome plated brass UNE-EN 12165. PTFE seats. Gas threaded ends (BSP) M-F ISO 228/1. Max. temp. 110°C. Butterfly handle operated aluminium.

R	P	A	L	M
1/8"	6,5	28	36	22
1/4"	6,5	28	37	22
3/8"	8	30	40	22
1/2"	10	33	44	22
3/4"	12,5	36	52	22

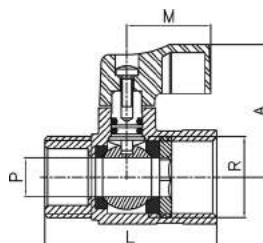

CÓDIGO CODE	MEDIDA SIZE	PESO WEIGHT	CAJA / BOX CARTON	P.V.P. € PRICE €
3097 01	1/8"	0,075	20-480	-
3097 02	1/4"	0,050	20-480	-
3097 03	3/8"	0,070	15-360	-
3097 04	1/2"	0,100	10-240	-
3097 05	3/4"	0,157	8-192	-
3097H 01	1/8"	0,075	20-480	-
3097H 02	1/4"	0,050	20-480	-
3097H 03	3/8"	0,070	15-360	-
3097H 04	1/2"	0,100	10-240	-
3097H 05	3/4"	0,157	8-192	-

Ref. 3451



Válvula de esfera mini con tuerca loca
 PN 16. Paso reducido. Construcción en latón cromado UNE-EN 12165. Asientos PTFE. Extremos rosca gas (BSP) M-H según ISO 228/1. Temp. máx. 110°C. Mando palomilla aluminio.

Mini ball valve with free nut
 PN 16. Reduced bore. Body chrome plated brass UNE-EN 12165. PTFE Seats. M-F gas (BSP) threaded ends according ISO 228/1. Max. temp. 110°C. Aluminium butterfly handle.

R1	R2	P	A	L	M
1/2"	1/2"	10	33	49	22
1/2"	3/4"	10	33	49	22
3/4"	3/4"	12,5	36	54	22

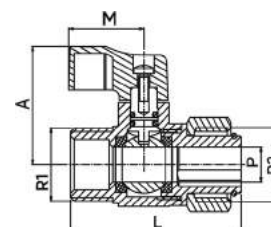

CÓDIGO CODE	MEDIDA SIZE	PESO WEIGHT	CAJA / BOX CARTON	P.V.P. € PRICE €
3451 04 04	1/2" x 1/2"	0,120	10-80	-
3451 04 05	1/2" x 3/4"	0,130	25-150	-
3451 05 05	3/4" x 3/4"	0,190	25-150	-

Ref. 3051

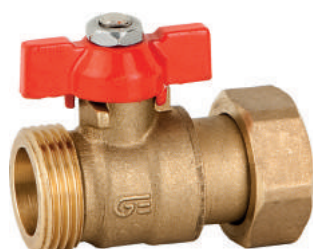

Válvula esfera recta con palomilla tuerca loca
 PN 16. Paso reducido. Construcción en latón según UNE-EN 12165. Asientos PTFE. Rosca gas (BSP) M-H tuerca loca según ISO 228/1. Temp. máx. 110°C. Accionamiento mediante palomilla de color rojo.

Straight ball valve with butterfly handle - free nut
 PN 16. Reduced bore. Body brass UNE-EN 12165. PTFE seats. Gas threaded (BSP) M-F free nut - ISO 228/1. Max. temp. 110°C. Butterfly red handle operated.

R	P	A	L	M
1/2" x 3/4"	10	34	45	40

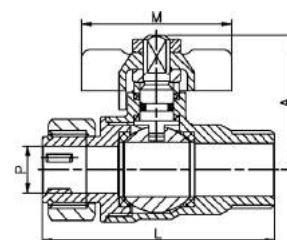

CÓDIGO CODE	MEDIDA SIZE	PESO WEIGHT	CAJA / BOX CARTON	P.V.P. € PRICE €
3051 04 05	1/2" x 3/4"	0,135	25-200	-

Ref. 3396



Válvula esfera mini

PN 16. Paso reducido. Construcción en latón cromado UNE-EN 12165. Asientos PTFE. Barra hexagonal cromada. Extremos rosca gas (BSP) H-H según ISO 228/1. Temp. máx. 110°C. Mando palomilla aluminio.

Mini ball valve

PN 16. Reduced bore. Hexagonal body chrome plated brass UNE-EN 12165. PTFE seats - female gas threaded ends (BSP) ISO 228/1. Max. Temp. 110°C. Butterfly handle operated aluminium.

R	P	A	L	M
1/8"	6	26	37	23
1/4"	8	26	40	23
3/8"	8	27	42	23
1/2"	10	28	45	23
3/4"	12	30	53	23

CÓDIGO CODE	MEDIDA SIZE	PESO WEIGHT	CAJA / BOX CARTON	P.V.P. € PRICE €
3396 01	1/8"	0,089	15-360	-
3396 02	1/4"	0,091	15-360	-
3396 03	3/8"	0,082	15-360	-
3396 04	1/2"	0,114	10-240	-
3396 05	3/4"	0,193	8-192	-

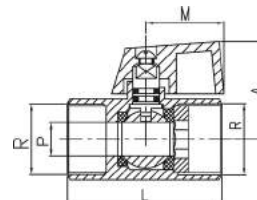

Ref. 3397



Válvula esfera mini

PN 16. Paso reducido. Construcción en latón cromado UNE-EN 12165. Asientos PTFE. Barra hexagonal cromada. Extremos rosca gas (BSP) M-H - según ISO 228/1. Temp. máx. 110°C. Mando palomilla aluminio.

Mini ball valve

PN 16. Reduced bore. Hexagonal body, chrome plated brass UNE-EN 12165. PTFE seats. M-F gas threaded ends (BSP) ISO 228/1. Max. Temp. 110°C. Aluminium butterfly handle.

R	P	A	L	M
1/8"	6	26	37	23
1/4"	8	26	40	23
3/8"	8	27	41	23
1/2"	10	28	45	23
3/4"	12	30	53	23

3397 01	1/8"	0,078	15-360	-
3397 02	1/4"	0,080	15-360	-
3397 03	3/8"	0,073	15-360	-
3397 04	1/2"	0,108	10-240	-
3397 05	3/4"	0,185	8-192	-

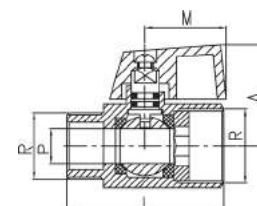

Ref. 3044



Válvula de descarga para caldera

PN 25. Paso total. Construcción en latón níquelado UNE-EN 12165. Asientos PTFE. Extremos rosca gas (BSP) M ISO 228/1 y conexión a manguera Ø 15 con tapón seguridad. Temp. máx. 110°C. Mando manual por palomilla aluminio color rojo.

Boiler discharge valve

PN 25. Full bore. Body brass UNE-EN 12165 Nickel-plated finishing. PTFE seats. Threaded end male ISO 228/1 and Ø 15 hose connection with safety cap. Max. Temp. 110°C. Aluminium butterfly red handle.

R x B	DN	H	L	M
G 1/2" x Ø15	10	34	72	35,5

3044 04	1/2" x Ø15	0,145	8-192	-
---------	------------	-------	-------	---

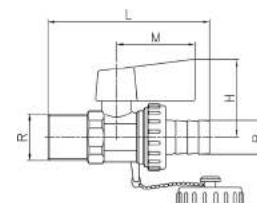

Ref. 3081



Válvula esfera soldar

PN 16. Paso total. Construcción en latón UNE-EN 12165. Asientos PTFE. Extremos para soldar. Temp. máx. 110°C. Mando manual por palanca acero.

Welding ball valve

PN 16. Full bore. Brass body UNE-EN 12165. PTFE seats. Welding ends. Max. Temp. 110°C. Steel lever manual control.

D	DN	A	L	M
Ø15	12	46	57	84
Ø18	15	47	64	84
Ø22	20	58	72	98
Ø28	25	61	85	98
Ø35	32	75	96	135
Ø42	40	80	115	135
Ø54	50	90	140	165

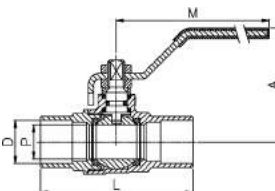

3081 15	Ø15	0,128	12-192	-
3081 18	Ø18	0,157	10-160	-
3081 22	Ø22	0,255	8-96	-
3081 28	Ø28	0,370	6-72	-
3081 35	Ø35	0,825	2-36	-
3081 42	Ø42	0,833	1-18	-
3081 54	Ø54	1,439	1-12	-

Ref. 3082



Válvula esfera soldar

PN 16. Paso total. Construcción en latón según UNE-EN 12165. Asientos PTFE. Extremos para soldar. Temp. máx. 110°C. Mando manual por palomilla aluminio.

Welding ball valve

PN 16. Full bore. Brass body UNE-EN 12165. PTFE seats. Welding ends. Max. Temp. 110°C. Aluminium butterfly handle operated.

D	DN	A	L	M
Ø15	12	39	57	50
Ø18	15	40	64	50
Ø22	20	50	72	62

3082 15	Ø15	0,109	10-240	-
3082 18	Ø18	0,137	8-192	-
3082 22	Ø22	0,222	5-120	-

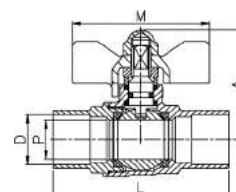

Ref. **K3000**

NEW

Kit prolongador

Distanciador de palanca en latón cromado según UNE-EN 12165. Para aplicar a los artículos indicados en la siguiente tabla.

Extension kit

Lever spacer in chromed brass UNE-EN 12165. For use of the items indicated in the table below.



Ref.	X (mm)	3020, 3021, 3022, 3029, 3032, 3033, 3034	3081
K3000 02	40	1"	022-028
K3000 03	51	1 1/4"-1 1/2"	035-042
K3000 04	55	2"	054

CÓDIGO CODE	MEDIDA SIZE	PESO WEIGHT	CAJA / BOX CARTON	P.V.P. € PRICE €
K3000 02	1"	0,090	20-480	-
K3000 03	1 1/4" - 1 1/2"	0,155	10-240	-
K3000 04	2"	0,240	10-240	-

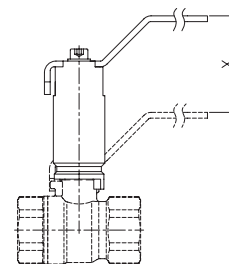

Ref. **3234**

Válvula esfera prolongada para aislamiento

PN 25. Paso total. Construcción en latón UNE-EN 12165. Asientos PTFE. Extremos rosca gas (BSP) H-H - ISO 228/1. Temp. máx. 110°C. Mando manual palanca acero.

Ball valve with extension for isolation

PN 25. Full bore. Brass construction UNE-EN 12165. PTFE seats. Gas threaded ends (BSP) F-F - ISO 228/1. Max. Temp. 110°C. Steel lever for manual control.



R	DN	L	A	M
G 1/2"	15	49	81,5	84
G 3/4"	20	56	85,5	84

3234 04	1/2"	0,188	5-90	-
3234 05	3/4"	0,260	4-72	-

Precios a consultar / Prices on request

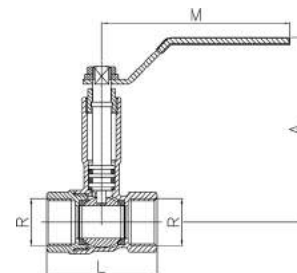

Ref. **3235**

Válvula esfera prolongada para aislamiento

PN 25. Paso total. Construcción en latón cromado UNE-EN 12165. Asientos PTFE. Extremos rosca gas (BSP) H-H - ISO 228/1. Temp. máx. 110°C. Mando manual palomilla aluminio.

Ball valve with extension for isolation

PN 25. Full bore. Body chrome plated brass construction UNE-EN 12165. PTFE seats. Gas threaded ends (BSP) F-F - ISO 228/1. Max. Temp. 110°C. Aluminium butterfly handle.



R	DN	L	A	M
G 1/2"	15	49	75	50
G 3/4"	20	56	78	50

3235 04	1/2"	0,195	5-120	-
3235 05	3/4"	0,280	4-96	-

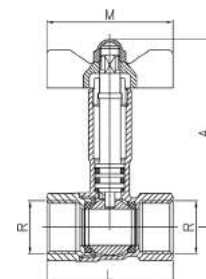

Ref. **3056**

Válvula de esfera empotrar rosca gas

PN 25. Paso total. Construcción en latón según UNE-EN 12165. Asientos PTFE. Extremos roscados gas (BSP) H-H ISO 228/1. Temp. máx. 110 °C.

Built-in gas threaded ball valve

PN 25. Full bore. Body brass UNE-EN 12165. PTFE seats. Gas threaded ends (BSP) F-F - ISO 228/1. Max. Temp. 110°C.



R	P	A	L
1/2"	15	79	49
3/4"	20	82	56
1"	25	86	68

3056 04	1/2"	0,180	15-120	-
3056 05	3/4"	0,248	12-96	-
3056 06	1"	0,375	6-48	-

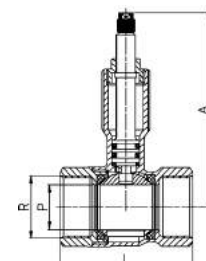

Ref. **3083**



Válvula de esfera empotrar soldar
PN 16. Paso total. Construcción en latón según UNE-EN 12165. Asientos PTFE. Extremos para soldar. Temp. máx. 110°C.

Built-in ball valve - welding ends
PN 16. Full bore. Body brass UNE-EN 12165. PTFE seats. Welding ends. Max. Temp. 110°C.

D	P	A	L
15	12	78	57
18	15	79	64
22	20	82	72

CÓDIGO CODE	MEDIDA SIZE	PESO WEIGHT	CAJA / BOX CARTON	P.V.P. € PRICE €
3083 15	Ø15	0,149	12-144	-
3083 18	Ø18	0,180	8-96	-
3083 22	Ø22	0,245	10-80	-

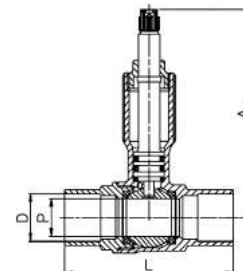

Ref. **3181**



Válvula empotrar tubería polibutileno con casquillos
PN 25. Paso total. Construcción en latón según UNE-EN 12165. Asientos PTFE. Conexión a tubería mediante racor de plástico. Temp. máx. 110 °C.

Built-in valve pipe polybutylene with sockets
PN 25. Full bore. Body brass UNE-EN 12165. PTFE seats. Connected to pipe by a plastic connector. Max. Temp. 110°C.

Ø Tubo/Pipe	P	L	A
Ø15	12	78	77
Ø22	19,5	86	82

3181 15	Ø15	0,267	12-168	-
3181 22	Ø22	0,401	8-64	-

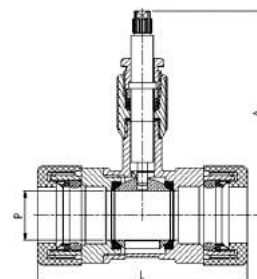

Ref. **3183**



Válvula empotrar tubería pex y multicapa con casquillos
PN 25. Paso total. Construcción en latón cromado según UNE-EN 12165. Asientos PTFE. Juntas casquillos de EPDM. Temp. máx. 110°C.

Built-in valve pex and multilayer pipe with sockets
PN 25. Full bore. Body chrome plated brass UNE-EN 12165. PTFE seats. EPDM sockets joints. Max. Temp. 110°C.

Ø Tubo/Pipe	P	L	A
Ø16 x 2	8	72	78
Ø20 x 2	12	80	79
Ø25 x 2,5	15	96,5	82,5
Ø32 x 3	20	97,5	82,5

3183 16	Ø16 x 2	0,194	12-120	-
3183 20	Ø20 x 2	0,214	8-112	-
3183 25	Ø25 x 2,5	0,300	8-64	-
3183 32	Ø32 x 3	0,362	10-60	-

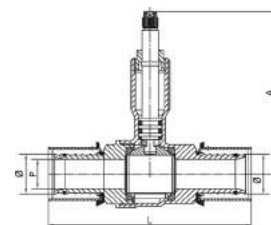

Ref. **3183B**

NEW



Válvula empotrar tubería PEX-a
PN25. Paso total. Construcción en latón UNE-EN 12165. Asientos PTFE. Temp. máx. 110°C.

Built-in ball valve PEX-a
PN25. Full bore. Brass construction UNE-EN 12165. PTFE seats. Max. temp. 110°C.

ØTubo/Pipe	P	L	A
Ø 16 x 1,8	10	71	79
Ø20 x 1,9	13	83	79
Ø25 x 2,3	18	101	83

3183B 16	Ø 16 x 1,8	0,169	-	-
3183B 20	Ø20 x 1,9	0,205	-	-
3183B 25	Ø25 x 2,3	0,308	-	-

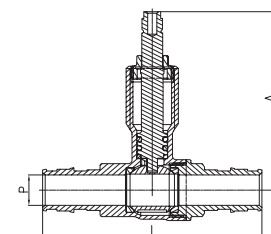

Ref. 3184



Válvula empotrar en "U" tubería pex y multicapa con casquillos
 PN 25. Paso estándar. Construcción en latón cromado según UNE-EN 12165. Asientos PTFE. Juntas casquillos de EPDM. Temp. máx. 110°C.

"U" built-in ball valve pex and multilayer pipe with sockets
 PN 25. Standard bore. Body chrome plated brass UNE-EN 12165. PTFE seats. EPDM sockets joints. Max.Temp. 110°C.

ØTubo/Pipe	L	A	B	C	D
Ø20 x 2	70	77	36	36	40
Ø25 x 2,5	87	80	46	36	50

CÓDIGO CODE	MEDIDA SIZE	PESO WEIGHT	CAJA / BOX CARTON	P.V.P. € PRICE €
3184 20	Ø20 x 2	0,287	6-60	-
3184 25	Ø25 x 2,5	0,445	4-40	-

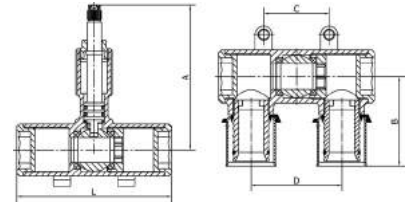

Ref. 3184B

NEW



Válvula empotrar en "U" para tubería PEX-a
 PN 25. Paso estándar. Construcción en latón UNE-EN 12165. Asientos PTFE. Temp. máx. 110°C.

"U" built-in ball valve for PEX-a pipe
 PN 25. Standard bore. Brass construction UNE-EN 12165. PTFE seats. Max. temp. 110°C.

ØTubo/Pipe	L	A	B	C
Ø20 x 1,9	70	77	40,5	36
Ø25 x 2,3	87	80	50,5	36

3184B 20	Ø20 x 1,9	0,305	-	-
3184B 25	Ø25 x 2,3	0,470	-	-

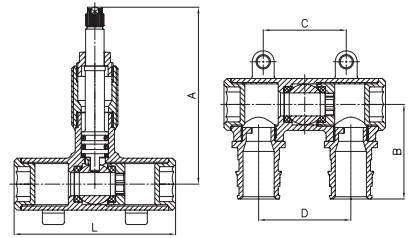

Ref. M3055



Maneta con florón
 Maneta adaptable a todas las medidas de nuestras válvulas 3056, 3083, 3181, 3183, 3183B, 3184 y 3184B. Construcción de maneta y florón en zamak, acabado cromado pulido. Con refuerzo en el aro de sujeción al grafilado del eje.

Handle with cover
 Handle adaptable to all sizes of our valves 3056, 3083, 3181, 3183, 3183B, 3184 and 3184B. Zamak body, handle and cover with polished chrom-plating. Reinforced fastening ring stem.

M3055	-	0,141	15-180	-
-------	---	-------	--------	---

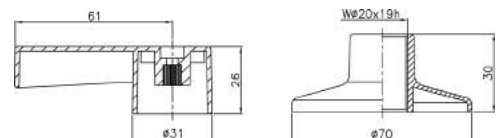

Ref. M3054



Mando oculto
 Permite ocultar eje accionador de llaves de paso empotradas. Construcción de pomo en latón según UNE-EN 12165 acabado cromado pulido. Construcción de florón en zamak acabado cromado pulido.

Hidden control
 Activating stem of the built-in shut off valve can be hidden. Polished chromed brass handle UNE-EN 12165. Zamak cover, polished chromed.

M3054	-	0,1	15-180	-
-------	---	-----	--------	---

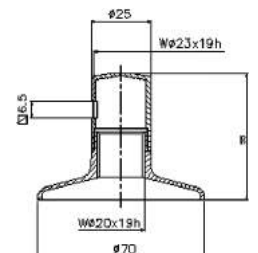

Ref. **M3057**



Maneta con florón

Maneta adaptable a todas las medidas de nuestras válvulas 3056, 3083, 3181, 3183, 3183B, 3184 y 3184B. Construcción de maneta y florón en zamak, acabado cromado y pulido. Con refuerzo en el aro de sujeción al grafilado del eje.

Handle with cover

Handle adaptable to all sizes of our valves 3056, 3083, 3181, 3183, 3183B, 3184 y 3184B. Zamak handle body and cover, polished chromed. Reinforced fastening ring stem.

CÓDIGO CODE	MEDIDA SIZE	PESO WEIGHT	CAJA / BOX CARTON	P.V.P. € PRICE €
-------------	-------------	-------------	-------------------	------------------

M3057	-	0,13	15-180	-
-------	---	------	--------	---

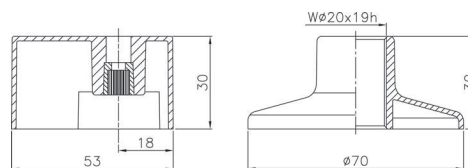

Ref. **K3052**



Kit prolongador válvulas empotrar

Permite alargar el eje de las válvulas en caso necesario. Construcción de alargó en latón según UNE-EN 12165. Construcción de florón en zamak - cromado y pulido.

Stretcher kit built-in-valves

Valve stem can be stretched if needed. Stretcher body brass UNE-EN12165. Zamak cover, polished chrom-plating.

K3052	-	-	15-180	-
-------	---	---	--------	---

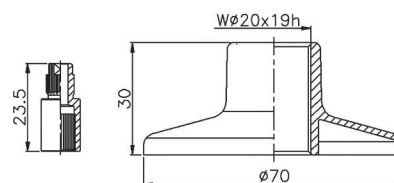

Ref. **3061**



Válvula manguera con dos salidas giratorias independientes

PN 16. Paso total. Construcción en latón UNE-EN 12165 cromado y pulido. Asientos PTFE. Entrada rosca gas (BSP) M - ISO 228/1. Temp. máx. 110°C. Una salida racor Rapid-Ge conexión manguera. Salidas giratorias 360° e independientes una de la otra. Mando palomilla de aluminio.

Bibcock valve with two independent outlet

PN 16. Full bore. Body chrome plated brass UNE-EN 12165 - chromed polished. PTFE seats. Gas threaded inlet (BSP) M - ISO 228/1. Max. Temp. 110°C. Aluminium butterfly handle. 1 Rapid-Ge outlet. Lever operated 360° outlets - independent from each other and rotatory. Aluminium butterfly handle.

3061 04	1/2" x 3/4"	0,378	1-60	-
---------	-------------	-------	------	---

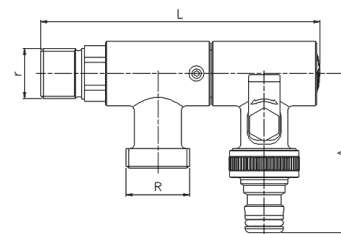

r	R	L	A
1/2"	3/4"	115	65

Ref. **3062**

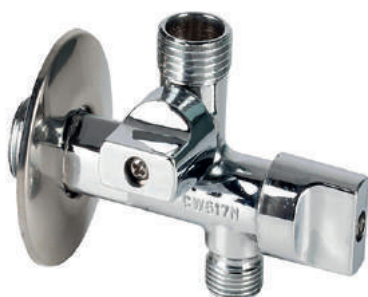

Válvula manguera con dos salidas independientes sin racor

PN 16. Paso estándar. Construcción en latón UNE-EN 12165 cromado y pulido. Mandos en ABS 1/4 vuelta. Asientos PTFE. Cierre central eje excéntrico (sistema Genebre) y cierre lateral mediante esfera. Extremos roscados gas (BSP) M ISO 228/1. Temp. máx. 110°C.

Bibcock valve with two independent outlet without hose connection

PN 16. Standard bore. Forged brass body UNE-EN 12165 chromed polished. ABS 1/4 turn handles. PTFE seats. Eccentric stem central closing (system Genebre) and ball lateral closing. Gas threaded ends (BSP) M ISO 228/1. Max. temp. 110°C.

3062 04 03	1/2" x 1/2" x 3/8"	0,152	1-144	-
3062 04 04	1/2" x 1/2" x 1/2"	0,153	1-144	-
3062 05 03	1/2" x 3/4" x 3/8"	0,160	1-144	-
3062 05 04	1/2" x 3/4" x 1/2"	0,166	1-144	-
3062 05 05	1/2" x 3/4" x 3/4"	0,169	1-144	-

R	r1	r2
1/2"	1/2"	3/8"
1/2"	1/2"	1/2"
1/2"	3/4"	3/8"
1/2"	3/4"	1/2"
1/2"	3/4"	3/4"

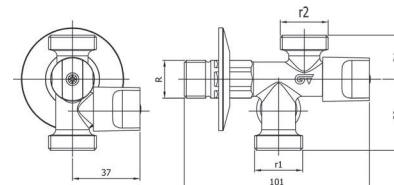

Ref. **3062R**



Válvula manguera con dos salidas independientes con Rapid-Ge conexión manguera

PN 16. Paso estándar. Construcción en latón UNE-EN 12165 cromado y pulido. Mandos en ABS 1/4 vuelta. Asientos PTFE. Cierre central eje excéntrico (sistema Genebre) y cierre lateral mediante esfera. Extremos roscados gas (BSP) M ISO 228/1. Una salida racor Rapid-Ge conexión manguera. Temp. máx. 110°C.

Bibcock valve with two independent outlet with Rapid-Ge hose connection

PN 16. Standard bore. Forged brass body UNE-EN 12165 chromed polished. ABS 1/4 turn handles. PTFE seats. Eccentric stem central closing (system Genebre) and ball lateral closing. Gas threaded ends (BSP) M ISO 228/1. One outlet with Rapid-Ge hose connection. Max. temp. 110°C.

3062R 05 05	1/2" x 3/4" x 3/4"	0,210	1-144	-
-------------	--------------------	-------	-------	---

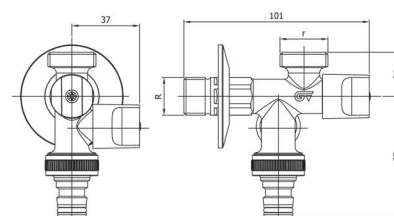

R	r
1/2"	3/4"

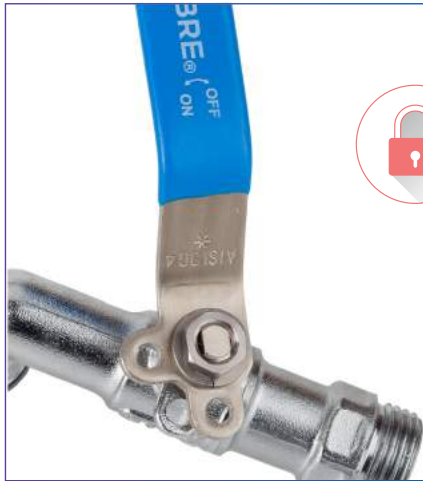

GELOCK SYSTEM

Algunas de nuestras válvulas para manguera incorporan el sistema de seguridad que permite fijar la posición deseada: *abierta - cerrada*

Some of our bibcock ball valves, incorporate the safety system that allows you to set the desired position: *open - close*

Ref. 3059

Válvula de esfera para manguera

PN 16. Paso total. Construcción en latón UNE-EN 12165 cromado. Asientos PTFE. Entrada rosca gas (BSP) M - ISO 228/1. Salida racor dos piezas conexión manguera. Temp. máx. 100°C. Mando manual por palanca de acero. Precintable en posición de apertura y cierre.

Bibcock ball valve

PN 16. Full bore. Body chrome plated brass UNE-EN 12165. PTFE Seats. Gas threaded inlet (BSP) M - ISO 228/1. 2 pieces hose connection outlet. Max. Temp. 100°C. Steel manual control lever. Lockable in open and close position.

R	r	P	A	L	M
1/2"	3/4"	10	88	85	84
3/4"	1"	12	95	95	84
1"	1"	15	112	119	98

CÓDIGO CODE	MEDIDA SIZE	PESO WEIGHT	CAJA BOX CARTON	P.V.P. € PRICE €
3059 04	1/2" x 3/4"	0,147	16-192	-
3059 05	3/4" x 1"	0,204	10-120	-
3059 06	1" x 1"	0,326	6-72	-

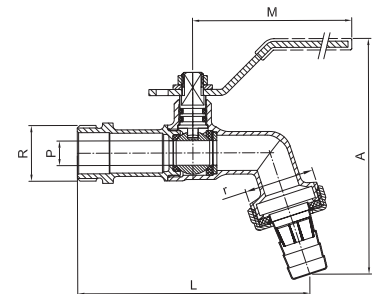

Ref. 3059R

Válvula de esfera para manguera

PN 16. Paso estándar. Construcción en latón UNE-EN 12165 cromado. Asientos PTFE. Entrada rosca gas (BSP) M - ISO 228/1. Salida racor dos piezas conexión manguera. Temp. máx. 100°C. Mando manual por palanca de acero. Precintable en posición de apertura y cierre.

Bibcock ball valve

PN 16. Standard bore. Body chrome plated brass UNE-EN 12165. PTFE Seats. Gas threaded inlet (BSP) M - ISO 228/1. 2 pieces hose connection outlet. Max. Temp. 100°C. Steel manual control lever. Lockable in open and close position.

R	r	P	A	L	M
1/2"	1/2"	9,5	89	85	84
3/4"	3/4"	9,5	89	86	84

3059R 04	1/2" x 1/2"	0,153	16-192	-
3059R 05	3/4" x 3/4"	0,174	10-120	-

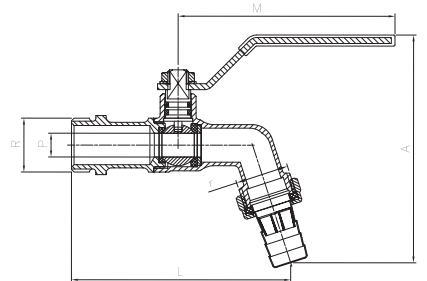
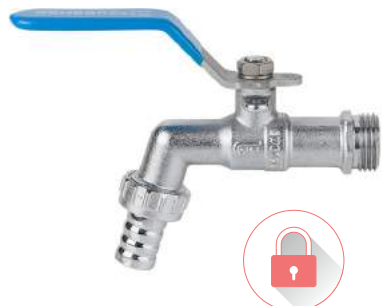

Ref. 3059D

Válvula de esfera para manguera con dos salidas

PN 16. Paso total. Construcción en latón UNE-EN 12165 cromado. Asientos PTFE. Entrada rosca gas (BSP) M - ISO 228/1. Salida racor dos piezas conexión manguera. Salida rosca macho 3/4". Temp. máx. 100°C. Mando manual por palanca de acero / aluminio. Precintable en posición de apertura y cierre.

Bibcock ball valve with two outlets

PN 16. Full bore. Body chrome plated brass UNE-EN 12165. PTFE Seats. Gas threaded inlet (BSP) M - ISO 228/1. 2 pieces hose connection outlet. 3/4" male threaded outlet. Max. Temp. 100°C. Steel / Aluminum manual control lever. Lockable in open and close position.

R	r1	r2	P	A	L	M
1/2"	3/4"	3/4"	10	88	104	84

3059D 04 05	1/2" x 3/4" x 3/4"	0,250	8-96	-
-------------	--------------------	-------	------	---

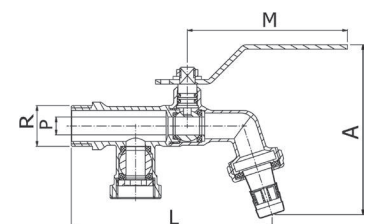

Ref. 3060



Válvula de esfera para manguera Rapid-Ge
 PN 16. Paso total. Construcción en latón UNE-EN 12165 cromado. Asientos PTFE. Entrada rosca gas (BSP) M - ISO 228/1. Salida racor Rapid-Ge conexión manguera. Temp. máx. 100°C. Mando manual por palanca de acero inoxidable. Precintable en posición de apertura y cierre.

Bibcock Rapid-Ge ball valve
 PN 16. Full bore. Body chrome plated brass UNE-EN 12165. PTFE Seats. Gas threaded inlet (BSP) M - ISO 228/1. Outlet with Rapid-Ge hose connection. Max. Temp. 100°C. Stainless steel lever manual control. Lockable in open and close position.

R	r	P	A	L	M
1/2"	3/4"	10	93	92	84
3/4"	1"	12	98	108	84
1"	1"	15	103	116	98

CÓDIGO CODE	MEDIDA SIZE	PESO WEIGHT	CAJA / BOX CARTON	P.V.P. € PRICE €
3060 04	1/2" x 3/4"	0,210	12-144	-
3060 05	3/4" x 1"	0,270	8-96	-
3060 06	1" x 1"	0,332	6-72	-

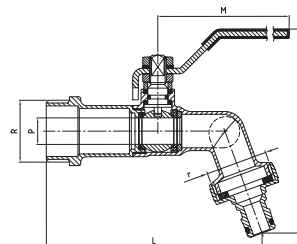

Ref. 3060F

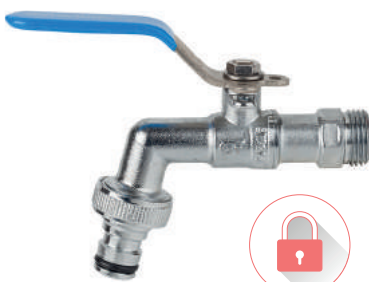

Válvula de esfera para manguera Rapid-Ge con sistema Anti-Hielo
 PN 16. Paso total. Construcción en latón UNE-EN 12165 cromado. Asientos PTFE. Entrada rosca gas (BSP) M - ISO 228/1. Salida racor Rapid-Ge conexión manguera. Temp. máx. 100°C. Mando manual por palanca de acero inoxidable. Precintable en posición de apertura y cierre. Orificio de descompresión Anti-Hielo.

Bibcock Rapid-Ge ball valve with antifreeze system
 PN 16. Full bore. Body chrome plated brass UNE-EN 12165. PTFE seats. Gas threaded ends (BSP) M - ISO 228/1. Outlet with Rapid-Ge hose connection. Max. Temp. 100°C. Stainless Steel lever manual control. Lockable in open and close position. Antifreeze decompression hole.

R	r	P	A	L	M
1/2"	3/4"	10	93	92	84

3060F 04	1/2" x 3/4"	0,195	12-144	-
----------	-------------	-------	--------	---

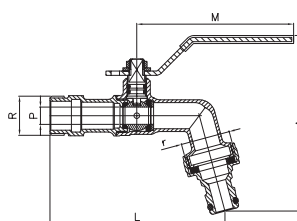

Ref. 3063



Válvula de esfera para manguera inoxidable Rapid-Ge
 PN 16. Paso estándar. Construcción en acero inoxidable AISI 316. Asientos PTFE. Entrada rosca gas (BSP) M - ISO 228/1. Salida racor Rapid-Ge conexión manguera. Temp. máx. 100°C. Mando manual por palanca de acero inoxidable. Precintable en posición de cierre.

Bibcock stainless steel Rapid-Ge ball valve
 PN 16. Standard bore. Stainless steel AISI 316 construction. PTFE Seats. Gas threaded inlet (BSP) M - ISO 228/1. Outlet with Rapid-Ge hose connection. Max. Temp. 100°C. Stainless steel manual control lever. Lockable in close position.

R	r	P	A	L	M
1/2"	3/4"	9,5	93	93	96

3063 04	1/2" x 3/4"	0,210	15-90	-
---------	-------------	-------	-------	---

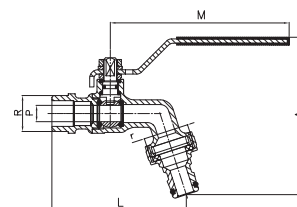

Ref. 3066



Válvula de esfera para manguera T-handle Rapid-Ge
 PN 16. Paso total. Construcción en latón UNE-EN 12165 cromado. Asientos PTFE. Entrada rosca gas (BSP) M - ISO 228/1. Salida racor Rapid-Ge conexión manguera. Temp. máx. 100°C. Accionamiento mediante maneta T.

Bibcock ball T-handle valve Rapid-Ge
 PN 16. Full bore. Body chrome plated brass UNE-EN 12165. PTFE Seats. Gas threaded (BSP) M - ISO 228/1. Outlet with Rapid-Ge hose connection. Max. Temp. 100°C. T-handle operated.

R	r	P	A	L	M
1/2"	3/4"	10	98	86	62
3/4"	1"	12	104	96	62

3066 04	1/2" x 3/4"	0,189	12-144	-
3066 05	3/4" x 1"	0,250	10-120	-

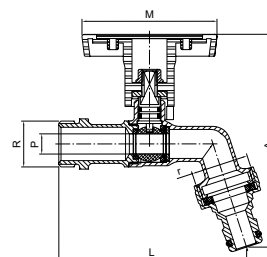

Ref. 3066B



Válvula de esfera para manguera
 PN 16. Paso total. Construcción en latón UNE-EN 12165 cromado. Asientos PTFE. Entrada rosca gas (BSP) M - ISO 228/1. Salida racor dos piezas conexión manguera. Temp. máx. 100°C. Mando manual por palomilla de aluminio.

Bibcock ball valve
 PN 16. Full bore. Body chrome plated brass UNE-EN 12165. PTFE Seats. Gas threaded inlet (BSP) M - ISO 228/1. 2 pieces hose connection outlet. Max. Temp. 100°C. Aluminium butterfly manual control.

R	r	P	A	L	M
1/2"	3/4"	10	82	85	50
3/4"	1"	12	88	95	50

3066B 04	1/2" x 3/4"	0,134	15-180	-
3066B 05	3/4" x 1"	0,190	8-96	-

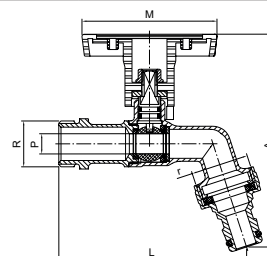

Ref. 3367

NEW



Válvula de esfera para manguera
 PN 16. Construcción en latón UNE-EN 12165 acabado cromado pulido. Asientos PTFE. Entrada rosca gas (BSP) M ISO 228/1. Salida racor dos piezas conexión manguera. Salida rosca macho 3/4". Temp. máx. 100°C. Mando palanca ZAMAK.

Bibcock ball valve
 PN16. Body polished chrome plated brass UNE-EN 12165. PTFE Seats. Male gas threaded end (BSP) ISO 228/1. 2 pieces hose connection outlet. 3/4" male threaded outlet. Max. temp. 100°C. ZAMAK lever control.

R	r	A	L	M
1/2"	3/4"	58	62	37

CÓDIGO CODE	MEDIDA SIZE	PESO WEIGHT	CAJA / BOX CARTON	P.V.P. € PRICE €
3367 04	1/2" x 3/4"	0,160	-	-

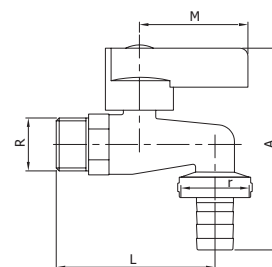

Ref. 3064



Válvula de esfera boca de riego vertical
 PN 16. Paso total. Construcción en latón UNE-EN 12165. Asientos PTFE. Entrada rosca gas (BSP) M - ISO 228/1. Salida racor "Rapid-Ge" para 1/2" y 3/4" y conexión manguera en 1". Temp. máx. 100°C. Accionamiento mediante maneta T.

Vertical water hydrant ball valve
 PN16. Full bore. Body brass UNE-EN 12165. PTFE Seats. Gas threaded (BSP) M - ISO 228/1. Outlet with "Rapid-Ge" for 1/2" and 3/4" and hose connection for 1". Max. Temp. 100°C. T-handle operated.

R	r	P	A	L	M
1/2"	3/4"	13	55	100	62
3/4"	1"	15	58	102	62
1"	1"	19	72	130	82

3064 04	1/2" x 3/4"	0,260	12-144	-
3064 05	3/4" x 1"	0,327	10-120	-
3064 06	1" x 1"	0,456	5-60	-

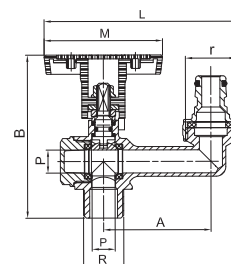

Ref. 3065



"Caja jardín" Válvula de esfera boca de riego vertical con caja y tapa
 Válvula de esfera boca de riego vertical ref. 3064 y arqueta de plástico con tapa color verde. Mando con la máxima altura para facilitar la apertura y cierre de la válvula con conexión Rapid-Ge.

"Garden box" water hydrant ball valve with cover
 Vertical water hydrant ball valve ref. 3064 and plastic box with green cover. Maximum height control to facilitate opening and closing of the valve Rapid-Ge connector.

A	Ø L	B
102	190	124
102	190	124

3065 04	1/2" x 3/4"	0,766	1-12	-
3065 05	3/4" x 1"	0,824	1-12	-

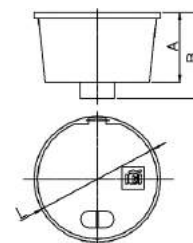

CÓDIGO CODE	MEDIDA SIZE	PESO WEIGHT	CAJA / BOX CARTON	P.V.P. € PRICE €
----------------	----------------	----------------	----------------------	---------------------

Ref. 3217



Conexión de manguera "Turbojet"

Conexión rosca tuerca loca hembra 3/4" ISO 228/1. Accionamiento manual por palanca de acero. Alta presión. Incluye 2 boquillas: función chorro y función lluvia. Longitud total 76 cm.

"Turbojet" hose connection

Connection thread female free nut 3/4" ISO 228/1. Steel manual control lever. High pressure. Includes 2 nozzles: stream and rain function. Total length 76 cm.

3217 00	3/4"	0,200	1-6	-
---------	------	-------	-----	---

Precio unitario / Unit price

Ref. R360



Racor manguera convencional

Adaptable a toda la serie de grifos manguera. Construcción en acero inox y latón según UNE-EN 12165. Acabado cromo pulido. Equipado con difusor de plástico para optimizar la homogeneidad del fluido.

Conventional hose connector

Adaptable to all kind of hose taps. Built in stainless steel and brass according to UNE-EN 12165. Polished chrome-plated finishing. Equipped with plastic diffuser to optimize the homogeneity of the fluid.

r	D	A
3/4"	15	31
1"	20,5	33
1"	26,5	42

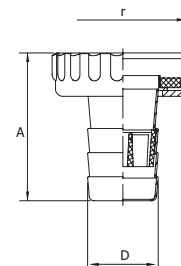

R360 04	3/4" x 15	0,035	50-600	-
R360 05	1" x 20,5	0,048	50-600	-
R360 06	1" x 26,5	0,054	25-300	-

Ref. 3211



Racor hembra rapid-Ge cromado

Sistema de anclaje adaptable a enchufe 3215. Construcción en latón según UNE-EN 12165 acabado cromado pulido.

Rapid-Ge quick female connector

Anchoring system adaptable to switch 3215. Body chrome plated brass UNE-EN 12165 - polished.

R	P	A	L
3/4"	9,5	34	28,5
1"	9,5	34	35,7

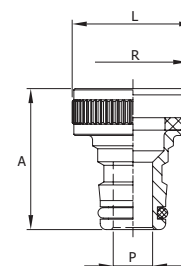

3211 05	3/4"	0,035	40-800	-
3211 06	1"	0,048	30-360	-

Ref. 3215



Enchufe manguera Rapid-Ge

Sistema convencional de anclaje adaptable a racor 3211. Construcción en latón según UNE-EN 12165.

Quick rapid-ge hose switch

Conventional anchoring system adaptable to connector 3211. Body brass UNE-EN 12165.

Ø A	L	Ø max. Tubo
29	44	18
36	50	26

3215 05	Ø18	0,124	20-240	-
3215 06	Ø26	0,139	20-240	-

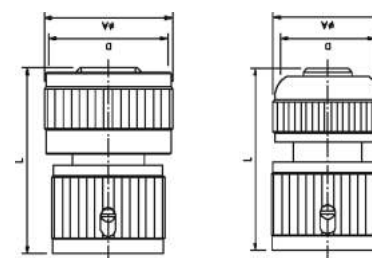

Ref. 3068



Válvula de esfera barril

PN 16. Paso estándar. Construcción en latón UNE-EN 12165 acabado pulido cromado. Asientos PTFE. Entrada rosca gas (BSP) macho - ISO 228/1. Temp. máx. 110°C. Mando manual por palomilla de aluminio.

Barrel ball valve

PN 16. Standard bore. Body chrome plated brass UNE-EN 12165 - polished. PTFE seats. Male gas threaded (BSP) inlet - ISO 228/1. Max. temp. 110°C. Aluminium butterfly handle.

R	DN	P	A	L	M
1/2"	7,5	9,5	75	77	50
3/4"	8,5	11,5	84	90	50

CÓDIGO CODE	MEDIDA SIZE	PESO WEIGHT	CAJA / BOX CARTON	P.V.P. € PRICE €
3068 04	1/2"	0,121	12-216	-
3068 05	3/4"	0,180	8-144	-

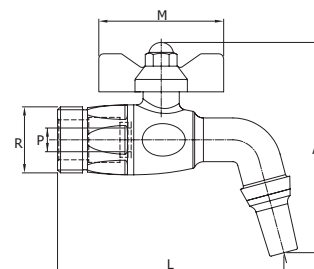

Ref. 2918



Válvula de esfera para barril

PN 16. Paso red. Construcción en acero inox - AISI 316. Asientos PTFE. Entrada rosca gas (BSP) macho según ISO 228/1. Temp. max. 110°C. Accionamiento mediante palomilla de acero inoxidable.

Barrel ball valve

PN 16. Reduced bore. Body stainless steel AISI 316. PTFE seats. Male gas threaded (BSP) inlet ISO 228/1. Max. temp. 110°C. Stainless steel butterfly handle operated.

R	A	L	M
3/8"	34	85	50
1/2"	34	85	50
3/4"	43	106	63

2918 03	3/8"	0,185	10-140	-
2918 04	1/2"	0,174	8-112	-
2918 05	3/4"	0,331	4-56	-

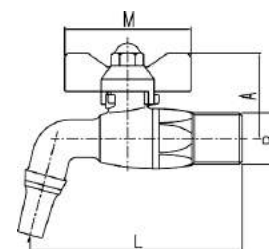

Ref. 2919



Válvula de esfera para barril

PN 16. Paso red. Construcción en acero inox - AISI 316. Entrada rosca cónica macho. Temp. máx. 110°C. Accionamiento mediante palomilla de acero inoxidable.

Barrel ball valve

PN 16. Reduced bore. Body stainless steel AISI 316. Male threaded conical inlet. Max. temp. 110°C. Stainless steel butterfly handle operated.

MED.	D	A	L	M
1/2"	18	34	85	50
3/4"	26	43	106	63

2919 04	1/2"	0,186	8-64	-
2919 05	3/4"	0,380	4-56	-

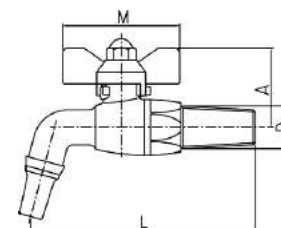

Ref. 3094



Válvula escuadra "Isis"

PN 10. Paso estándar. Construcción en latón cromado según UNE-EN 12165. Extremos rosca gas (BSP) M-M según ISO 228/1. Temp. máx. 110°C. Mando ABS 1/4 de vuelta. Cierre mediante eje excéntrico (Sistema Genebre).

"Isis" angle valve

PN 10. Standard bore. Made in chromed brass according to UNE-EN 12165. Gas threaded ends (BSP) M-M ISO 228/1. Max. Temp. 110°C. ABS 1/4 turn handle. Eccentric stem closing system (Genebre system).

R	r	P	L	D
1/2"	3/8"	6	83	50
1/2"	1/2"	6	83	50

3094 04	1/2" x 3/8"	0,074	2-240	-
3094 05	1/2" x 1/2"	0,077	2-240	-

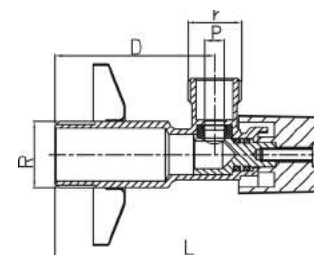

Ref. 3094E



Válvula escuadra económica

PN 10. Paso estándar. Construcción en latón cromado según UNE-EN 12165. Extremos rosca gas (BSP) M-M según ISO 228/1. Temp. máx. 110°C. Mando ABS 1/4 de vuelta. Cierre mediante eje excéntrico (Sistema Genebre).

Economic angle valve

PN 10. Standard bore. Made in chromed brass according to UNE-EN 12165. Gas threaded ends (BSP) M-M ISO 228/1. Max. Temp. 110°C. ABS 1/4 turn handle. Eccentric stem closing system (Genebre system).

R	r	P	L	D
1/2"	3/8"	6	78	45
1/2"	1/2"	6	78	45

3094E 04	1/2" x 3/8"	0,090	2-240	-
3094E 05	1/2" x 1/2"	0,083	2-240	-

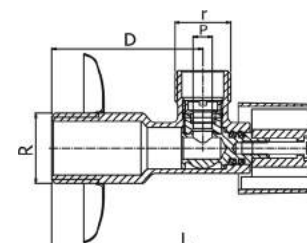

Ref. 3294

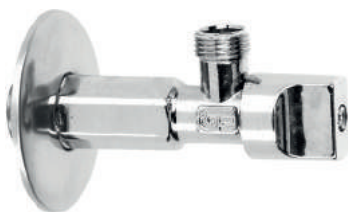

Válvula escuadra alargada

PN 10. Paso estándar. Construcción en latón cromado según UNE-EN 12165 . Extremos rosca gas (BSP) M-M según ISO 228/1. Temp. máx. 110°C. Mando ABS 1/4 de vuelta. Cierre mediante eje excéntrico (Sistema Genebre).

Long angle valve

PN 10. Standard bore. Made in chromed brass according to UNE-EN 12165. Gas threaded ends (BSP) M-M ISO 228/1. Max. Temp. 110°C. ABS 1/4 turn handle. Eccentric stem closing system (Genebre system).

R	r	P	L	D
1/2"	3/8"	6	95	62
1/2"	1/2"	6	95	62

CÓDIGO CODE	MEDIDA SIZE	PESO WEIGHT	CAJA / BOX CARTON	P.V.P. € PRICE €
-------------	-------------	-------------	-------------------	------------------

3294 04	1/2" x 3/8"	0,094	2-200	-
3294 05	1/2" x 1/2"	0,098	2-200	-

Precios a consultar / Prices on request

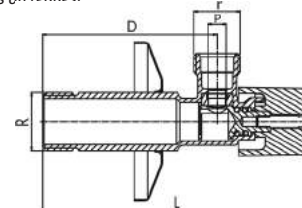

Ref. 3104

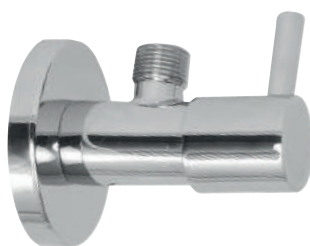

Válvula escuadra redonda "Tau"

PN 10. Construcción de cuerpo y florón en latón según UNE-EN 12165 . Cromado según EN 248. Extremos roscados gas (BSP) M-M según ISO 228/1. Apertura y cierre por montura cerámica. Temp. máx. 85°C.

Round angle valve "Tau"

PN 10. Body and cover made in brass according to UNE-EN 12165. Chrome plated according to EN 248. Gas threaded ends (BSP) M-M ISO 228/1. Opening and closing operation by ceramic headwork. Max.temp. 85°C.

R	r	P	L	D
1/2"	3/8"	10	81	41
1/2"	1/2"	10	81	41

3104 04	1/2" x 3/8"	0,166	2-120	-
3104 05	1/2" x 1/2"	0,152	2-120	-

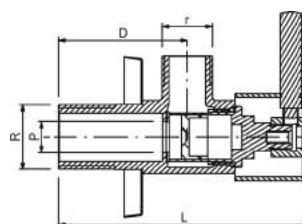

Ref. 3107 - 3108



Válvula mixta teleducha bide-WC dos salidas

PN 10. Disponible versión cromada (3107) y versión inoxidable (3108). Válvula de escuadra doble 1/2" - 3/8". Apertura y cierre por montura cerámica. Temp.máx. 85°C.

Bidet-WC mixed shower valve 2 outlets

PN 10. Available in chromed (3107) and stainless steel finish (3108). Double angle valve 1/2" - 3/8". Opening and closing operation by ceramic headwork. Max.temp. 85°C.

3107 03	1/2" x 1/2" x 3/8"	0,138	1-160	-
3107 04	1/2" x 1/2" x 1/2"	0,144	1-160	-

3108 03	1/2" x 1/2" x 3/8"	138,000	1-160	-
3108 04	1/2" x 1/2" x 1/2"	144,000	1-160	-

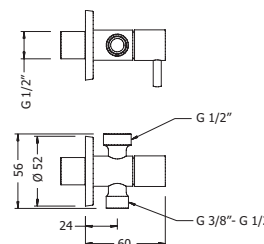

Ref. 3109



Válvula manguera con dos salidas independientes

PN 10. Construcción en latón según UNE-EN 12165 cromado y pulido. Extremos roscados gas (BSP) M-M según ISO 228/1. Apertura y cierre por montura cerámica. Temp. máx. 85°C.

Bibcock valve with two independent outlets

PN 10. Made in brass according to UNE-EN 12165 chrome-plated and polished. Gas threaded ends (BSP) M-M ISO 228/1. Opening and closing operation by ceramic headwork. Max. temp. 85°C.

R	r1	r2	L	A	B
1/2"	3/8"	1/2"	114	26	39
1/2"	1/2"	1/2"			

3109 04	1/2 x 3/8" x 1/2"	0,262	1-90	-
3109 05	1/2 x 1/2" x 1/2"	-	-	-

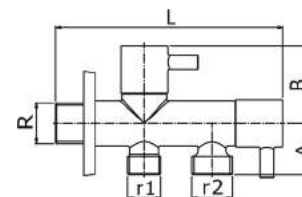

Ref. 3106



Válvula escuadra cuadrada "Cubik"

PN 10. Construcción de cuerpo y florón en latón según UNE-EN 12165 . Cromado según EN 248. Extremos roscados gas (BSP) M-M según ISO 228/1. Apertura y cierre por montura cerámica. Temp. máx. 85°C.

Square angle valve "Cubik"

PN 10. Body and cover made in brass according to UNE-EN 12165. Chrome plated according to EN 248. Gas threaded ends (BSP) M-M ISO 228/1. Opening and closing operation by ceramic headwork. Max.temp. 85°C

R	r	P	L	D
1/2"	3/8"	10	74	35
1/2"	1/2"	10	74	35

3106 04	1/2" x 3/8"	0,210	2-120	-
3106 05	1/2" x 1/2"	0,212	2-120	-

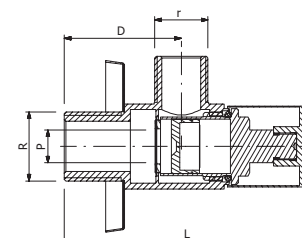

Ref. 3095



Válvula de escuadra con filtro

PN 10. Paso estándar. Construcción en latón según UNE-EN 12165 acabado cromado pulido. Extremos roscados macho según ISO 228/1. Temp. máx. 110°C. Filtro inox.

Angle valve with strainer

PN 10. Standard bore. Chrome plated brass body UNE-EN 12165 - polished. Male threaded ends (BSP) DIN 228/1. Max. temp. 110°C. Stainless steel strainer.

R	r	P	A	L
1/2"	3/8"	8	50	59
1/2"	1/2"	8	50	59
1/2"	3/4"	8	54	63

CÓDIGO CODE	MEDIDA SIZE	PESO WEIGHT	CAJA / BOX CARTON	P.V.P. € PRICE €
3095 03	1/2" x 3/8"	0,090	10-240	-
3095 04	1/2" x 1/2"	0,095	10-240	-
3095 05	1/2" x 3/4"	0,106	10-240	-

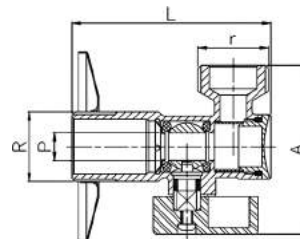

Ref. 3095N



Válvula de escuadra con filtro - rosca NPT

PN 10. Paso estándar. Construcción en latón según UNE-EN 12165. Acabado cromado pulido. Extremos roscados macho NPT según ANSI B 1.20.1 y UNEF 9/16 según ASME B 1.1. Temp. máx. 110°C. Filtro inox.

Angle valve with strainer - NPT thread

PN 10. Standard bore. Brass construction according UNE-EN 12165. Polished chrome plated. Male thread ends NPT according ANSI B 1.20.1 and UNEF 9/16 according ASME B 1.1. Máx. temp. 110°C. Stainless steel strainer.

R	r	P	A	L
1/2"	UNEF 9/16 24H	8	50	59

3095N 04	1/2" NPT x UNEF 9/16 24H	0,185	10-240	-
----------	--------------------------	-------	--------	---

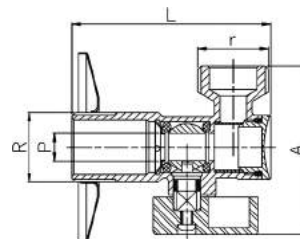

Ref. 3195N



Válvula de escuadra con filtro - rosca NPT

PN 10. Paso estándar. Construcción en latón según UNE-EN 12165. Acabado cromado pulido. Extremos roscados hembra NPT según ANSI B 1.20.1 y macho según ASME B 1.1 o según ISO 228/1. Temp. máx. 110°C. Filtro inox.

Angle valve with strainer - NPT thread

PN 10. Standard bore. Brass construction according UNE-EN 12165. Polished chrome plated. Female NPT thread end according to ANSI B 1.20.1 and male according to ASME B 1.1 or according to ISO 228/1. Max. temp. 110°C. Stainless steel strainer.

R	r	P	A	L
1/2" NPT	G3/8"	8	50	59
1/2" NPT	UNEF 9/16 24H	8	50	59

3195N 03	1/2" NPT x G3/8"	0,090	10-240	-
3195N 04	1/2" NPT x UNEF 9/16 24H	0,095	10-240	-

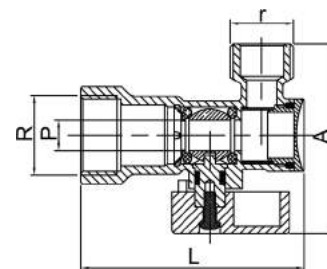

Ref. 3196N



Válvula de escuadra con filtro-rosca NPT

PN10. Paso estándar. Construcción el latón según UNE-EN 12165. Acabado cromado pulido. Extremos rosca hembra NPT según ANSI B 1.20.1 y macho gas (BSP), ISO 228/1. Temperatura máxima 110°C. Filtro acero inoxidable.

Angle valve with strainer- NPT thread

PN10. Standard bore. Brass construction according UNE-EN 12165. Polished chrome plated. Female NPT thread according ANSI B 1.20.1 and male Gas threaded (BSP), ISO 228/1. Maximum temperature 110°C. Stainless steel strainer.

R	r	P	A	L	M
1/2" NPT	G1/2"	8	50	59	31

3196N 04 04	1/2" NPT x G1/2"	0,104	10-240	-
-------------	------------------	-------	--------	---

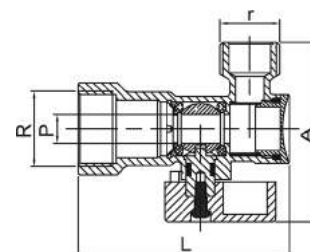

Ref. 3090



Válvula escuadra lavadora

PN 10. Paso estándar. Construcción en latón según UNE-EN 12165 cromado. Asientos NBR. Extremos rosca gas (BSP) M-M ISO 228/1. Temp. máx. 110°C. Mando manual por palomilla ABS.

Washing machine angle valve

PN 10. Standard bore. Body brass UNE-EN 12165. NBR seats - M-M gas threaded ends (BSP) ISO 228/1. Max. temp. 110°C. ABS butterfly handle operated.

r	R	P	A	L	M
1/2"	3/4"	9	65	49	39

CÓDIGO CODE	MEDIDA SIZE	PESO WEIGHT	CAJA / BOX CARTON	P.V.P. € PRICE €
3090 04	1/2" x 3/4"	0,110	10-180	-

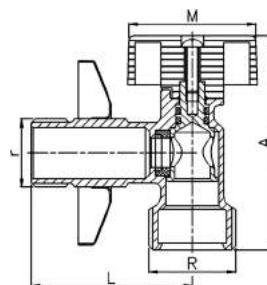

Ref. 3392

NEW



Válvula lavadora simple cromada modelo "TEK"

PN16. Paso estándar. Construcción en latón UNE-EN 12165 acabado cromado pulido. Extremos roscados rosca gas (BSP) M ISO 228/1. Temp. máx. 100°C. Accionamiento mediante volante.

"TEK" chrome-plated simple washing machine valve

PN16. Standard bore. Body polished chrome plated brass UNE-EN 12165. Male gas threaded end (BSP) ISO 228/1. Max. temp. 100°C. Hand wheel operated.

R	r	A	L	M
1/2"	3/4"	24,5	51	32

3392 04	1/2" x 3/4"	0,194	-	-
---------	-------------	-------	---	---

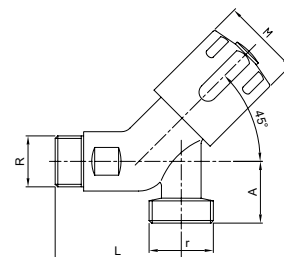

Ref. 3091



Válvula de esfera escuadra lavadora

PN 16. Paso estándar. Construcción en latón según UNE-EN 12165 cromado. Asientos PTFE. Extremos rosca gas (BSP) M-M ISO 228/1. Temp. máx. 110°C. Mando ABS 1/4 de vuelta.

Washing machine angle valve

PN 16. Standard bore. Body brass according UNE-EN 12165 chrome plated. PTFE seats. Gas threaded ends (BSP) M-M ISO 228/1. Max. temp. 110°C. ABS 1/4 turn handle.

R	r	A	L	M
1/2"	3/4"	75	48	34

3091 04	1/2" x 3/4"	0,155	10-180	-
---------	-------------	-------	--------	---

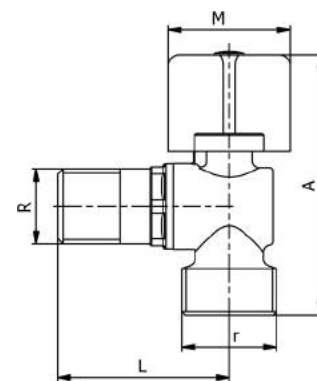

Ref. 3092



Válvula mixta lavadora – lavabo

PN 16. Paso total. Construcción en latón según UNE-EN 12165. Acabado cromado pulido. Extremos roscados gas (BSP) según ISO 228/1 - accionamiento mediante volante. Temp. máx. 110°C.

Washing machine – washbasin mixed valve

PN 16. Full bore. Chrome plated brass body UNE-EN 12165 - polished. Gas threaded ends (BSP) ISO 228/1. Hand wheel operated. Max. temp. 110°C.

R1	R2	r	A	L
1/2"	3/4"	3/8"	80,5	115

3092 04	1/2"	0,273	1-80	-
---------	------	-------	------	---

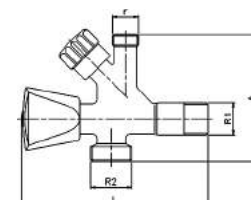

Ref. 3121 - 3121N



Válvula de retención "Re-Ge"

También disponible con rosca NPT (3121N).
PN 25/12. Construcción en latón UNE-EN 12165. Junta de clapeta vulcanizada de NBR. Muelle en acero inox. AISI 304. Extremos rosca gas (BSP) H-H - ISO 228/1. Temp. máx. 90°C. Montaje en cualquier posición.

Re-Ge check valve

Also available NPT thread (3121N).
PN 25/12. Body brass UNE-EN 12165. Vulcanized NBR gasket plate. Stainless steel spring AISI 304. Gas threaded ends (BSP) F-F ISO 228/1. Max. temp. 90°C. Multipositional setting up.

PN 25/12. Construcción en latón UNE-EN 12165. Junta de clapeta vulcanizada de NBR. Muelle en acero inox. AISI 304. Extremos rosca gas (BSP) H-H - ISO 228/1. Temp. máx. 90°C. Montaje en cualquier posición.

PN 25/12. Body brass UNE-EN 12165. Vulcanized NBR gasket plate. Stainless steel spring AISI 304. Gas threaded ends (BSP) F-F ISO 228/1. Max. temp. 90°C. Multipositional setting up.

CÓDIGO CODE	MEDIDA SIZE	PESO WEIGHT	CAJA / BOX CARTON	P.V.P. € PRICE €
3121 04	1/2"	0,110	30-270	-
3121 05	3/4"	0,178	24-192	-
3121 06	1"	0,259	12-96	-
3121 07	1 1/4"	0,375	10-60	-
3121 08	1 1/2"	0,513	5-40	-
3121 09	2"	0,795	2-16	-
3121 10	2 1/2"	1,621	1-15	-
3121 11	3"	2,349	1-12	-
3121 12	4"	3,817	1-5	-

Precios rosca NPT a consultar / NPT thread prices on request

R	PN	D	A
1/2"	25	30	50
3/4"	25	37	57
1"	25	43	65
1 1/4"	18	53	70
1 1/2"	18	65	76
2"	18	80	82
2 1/2"	12	104	104
3"	12	124	113
4"	12	155	132

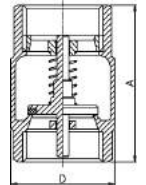

Ref. 3122P - 3122PN



Válvula de retención "REGE PLUS"

PN 25/18. Construcción en latón cromado según UNE-EN 12165. Cierre NBR vulcanizado. Muelle acero inox. AISI 304. Extremos rosca gas (BSP) H-H según ISO 228/1. Temp. máx. 90°C. Montaje en cualquier posición.

"REGE PLUS" check valve

PN 25/18. Made in chrome-plated brass according to UNE-EN 12165. Vulcanized NBR sealing. Stainless steel AISI 304 spring. Gas threaded ends (BSP) F-F ISO 228/1. Max. temp. 90°C. Install in any position.

R	PN	D	A
1/2"	25	28	57
3/4"	25	35	64
1"	25	42	75
1 1/4"	18	52	82
1 1/2"	18	63	93
2"	18	78	100

3122P 04	1/2"	0,110	30-240	-
3122P 05	3/4"	0,190	24-96	-
3122P 06	1"	285,000	12-96	-
3122P 07	1 1/4"	405,000	8-48	-
3122P 08	1 1/2"	0,585	6-36	-
3122P 09	2"	0,885	2-16	-

Precios rosca NPT a consultar / NPT thread prices on request

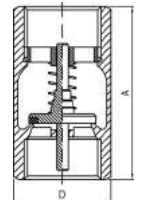

Ref. 3141



Válvula de pie

PN 25/18 Paso total. Construcción en latón cromado UNE-EN 12165. Extremo roscado gas (BSP) H ISO 228/1. Temp. máx. 90°C. Cierre NBR vulcanizado. Muelle y tamiz inox. AISI 304. Presión mínima trabajo 0,03 bar.

Check valve with filter

PN 25/18. Body chrome plated brass UNE-EN 12165. Gas threaded end F ISO 228/1. Max. temp. 90°C. Vulcanized NBR sealing. Stainless steel spring and sieve AISI 304. Minimum working pressure 0 - 03 bar.

R	PN	P	A	D
1/2"	25	15	78	28
3/4"	25	20	91	35
1"	25	25	97	42
1 1/4"	18	32	113	52
1 1/2"	18	40	128	63
2"	18	50	150	78

3141 04	1/2"	0,090	12-252	-
3141 05	3/4"	0,135	8-112	-
3141 06	1"	235,000	6-60	-
3141 07	1 1/4"	0,285	5-50	-
3141 08	1 1/2"	510,000	4-32	-
3141 09	2"	760,000	2-28	-

Disponible en 2 1/2", 3" y 4" consultar precios / Available in 2 1/2", 3" and 4" prices on request

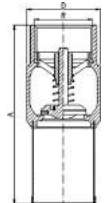

Ref. 3123



Válvula esfera con retención

Válvula esfera con retención PN 25. Paso total. Construcción en latón UNE-EN 12165 cromado. Asientos PTFE. Extremos roscados H-H ISO 228/1. Temp. máx. 90°C. Accionamiento esfera palomilla. Cierre retención NBR vulcanizado. Muelle acero inox AISI 304. Presión mínima trabajo 0,03 bar.

Ball valve with check valve

PN 25. Full bore. Body chrome plated brass UNE-EN 12165. PTFE seats. Threaded ends F-F ISO 228/1. Max. temp. 90°C. Ball working butterfly handle. Vulcanized NBR check valve sealing. Stainless steel spring AISI 304. Minimum working pressure 0 - 03 bar.

R	P	A	L	M
1/2"	15	76	50	50
3/4"	20	91	62	62
1"	25	106	69	62

3123 04	1/2"	0,186	10-160	-
3123 05	3/4"	0,337	6-60	-
3123 06	1"	0,519	4-40	-

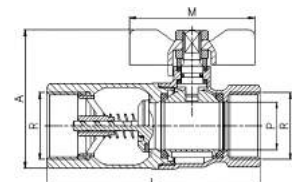

Ref. 3124

NEW



Válvula de retención para tubería PE

PN 16. Construcción en latón forjado según UNE-EN 12165. Conexión a tubería mediante sistema de apriete diseño Genebre "RAC-GE". Temperatura de trabajo de -10°C a 90°C. Aplicable para la unión con tubo de polietileno en baja media y alta densidad. Cierre NBR vulcanizado. Muelle acero inox. AISI 304. Montaje en cualquier posición.

Check valve for PE pipe

PN 16. Forged brass according to UNE-EN 12165. Genebre's designed "RAC-GE" air tight system for connection to pipe. Working temp. -10°C to 90°C. Applicable for the connection of low, medium and high density polyethylene pipe. Vulcanized NBR sealing. Stainless steel AISI 304 spring. Install in any position.

	P	Ø D	A
PE25 x PE25	20	41	85
PE32xPE32	25	50	100
PE40 x PE40	32	60	120

CÓDIGO CODE	MEDIDA SIZE	PESO WEIGHT	CAJA / BOX CARTON	P.V.P. € PRICE €
-------------	-------------	-------------	-------------------	------------------

3124 05	25x25	0,284	-	-
3124 06	32x32	0,463	-	-
3124 07	40x40	0,744	-	-

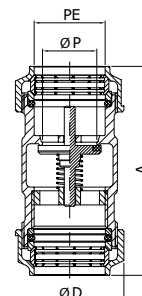

Ref. 3120



Válvula de retención "York"

PN 12 - PN 10 - PN 8. Construcción en latón UNE-EN 12165. Obturador de disco en poliamida 6. Cierre en NBR (goma) 65 sh. Muelle en acero inox. AISI 302. Extremos rosca gas (BSP) H-H - ISO 228/1. Temp. máx. 100°C. Montaje en cualquier posición.

"York" check valve

PN 12 - PN 10 - PN 8. Body brass UNE-EN 12165. NBR (rubber) sealing 65 sh/ps. Stainless steel spring - AISI 302. Gas threaded ends (BSP) F-F ISO 228/1. Max. temp. 100°C. Assembling: any position.

R	PN	P	B	A
3/8"	12	10	34	46
1/2"	12	15	34	47
3/4"	12	20	42	52
1"	12	25	48	60
1 1/4"	10	32	59	66
1 1/2"	10	40	70	73
2"	10	50	86	79
2 1/2"	8	65	102	97
3"	8	80	125	103
4"	8	100	153	119

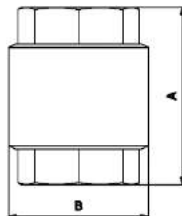

3120 03	3/8"	0,130	10-200	-
3120 04	1/2"	0,134	10-200	-
3120 05	3/4"	0,250	8-128	-
3120 06	1"	0,280	8-88	-
3120 07	1 1/4"	0,390	6-54	-
3120 08	1 1/2"	0,610	4-36	-
3120 09	2"	0,800	2-28	-
3120 10	2 1/2"	1,450	1-16	-
3120 11	3"	2,110	1-12	-
3120 12	4"	3,290	1-7	-

Ref. 3131



Válvula de retención "Europa"

PN 25 - PN 18 - PN 12. Construcción en latón UNE-EN 12165. Cierre en NBR (goma) 65 sh. Muelle en acero inox. AISI 302. Extremos rosca gas (BSP) H-H - ISO 228/1. Temp. máx. 100°C. Montaje en cualquier posición.

"Europa" check valve

PN 25 - PN 18 - PN 12. Body brass UNE-EN 12165. NBR (rubber) sealing 65 sh/ps. Stainless steel spring AISI 302. Gas threaded ends (BSP) F-F - ISO 228/1. Max. temp. 100°C. Assembling: any position.

R	PN	P	B	A
3/8"	25	10	35	54
1/2"	25	15	35	57
3/4"	25	20	42	64
1"	25	25	48	75
1 1/4"	18	32	61	82
1 1/2"	18	40	71	93
2"	18	50	87	100
2 1/2"	12	65	120	120
3"	12	79	140	140
4"	12	100	173	158

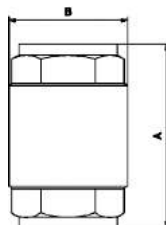

3131 03	3/8"	0,175	10-130	-
3131 04	1/2"	0,190	10-120	-
3131 05	3/4"	0,275	8-88	-
3131 06	1"	0,400	6-54	-
3131 07	1 1/4"	0,635	4-36	-
3131 08	1 1/2"	0,850	4-32	-
3131 09	2"	1,300	2-20	-
3131 10	2 1/2"	2,740	1-9	-
3131 11	3"	4,000	1-6	-
3131 12	4"	6,450	1-4	-

Ref. 3140



Válvula de pie "York"

PN 12 - PN 10 - PN 6. Construcción en latón UNE-EN 12165. Cierre en NBR (goma) 65 sh. Muelle en acero inox. AISI 302. Extremo rosca gas (BSP) H - ISO 228/1. Temp. máx. 100°C.

"York" valve with filter

PN 12 - PN 10 - PN 6. Body brass UNE-EN 12165. NBR (rubber) sealing 65 sh. Stainless steel spring AISI 302. Gas threaded end (BSP) F - ISO 228/1. Max. temp. 100°C.

R	PN	P	B	A
3/8"	12	10	35	69,5
1/2"	12	15	35	70
3/4"	12	20	42	82
1"	12	25	48	91,5
1 1/4"	10	32	59,5	108
1 1/2"	10	40	70,5	119
2"	10	50	86	136,5
2 1/2"	6	65	103	164,5
3"	6	80	126	184,5
4"	6	100	154	214,5

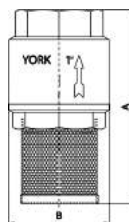

3140 03	3/8"	0,090	10-220	-
3140 04	1/2"	0,100	10-220	-
3140 05	3/4"	0,140	8-144	-
3140 06	1"	0,195	8-120	-
3140 07	1 1/4"	0,275	6-60	-
3140 08	1 1/2"	0,430	4-48	-
3140 09	2"	0,610	2-26	-
3140 10	2 1/2"	1,065	1-25	-
3140 11	3"	1,650	1-17	-
3140 12	4"	2,475	1-10	-

Ref. 3160 - 3160N



Filtro válvula retención

También disponible con rosca NPT (3160N).
 Tamiz acero inox - AISI 304. Racor nylon 6.6. Extremos rosca gas (BSP) M - ISO 228/1.

Stainless steel strainer for check valves

Also available NPT thread (3160N).
 Stainless steel sieve AISI 304. Nylon 6.6. Gas threaded end (BSP) M - ISO 228/1.

R	Luz/Light (microns)	D	A
3/8"	1000	49	23
1/2"	1000	51	27
3/4"	1000	57	34
1"	1000	58	40
1 1/4"	1000	69	48
1 1/2"	1000	81	58
2"	1000	96	68
2 1/2"	1200	96	83
3"	1200	116	100
4"	1200	132	127

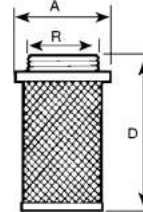

CÓDIGO CODE	MEDIDA SIZE	PESO WEIGHT	CAJA / BOX CARTON	P.V.P. € PRICE €
3160 03	3/8"	0,006	30-900	-
3160 04	1/2"	0,008	30-900	-
3160 05	3/4"	0,011	15-450	-
3160 06	1"	0,028	15-270	-
3160 07	1 1/4"	0,024	10-180	-
3160 08	1 1/2"	0,035	10-120	-
3160 09	2"	0,056	5-60	-
3160 10	2 1/2"	0,078	1-48	-
3160 11	3"	0,129	1-18	-
3160 12	4"	0,186	1-18	-

Precios rosca NPT a consultar / NPT thread prices on request

Ref. 3145 - 3145N



Válvula fondo

También disponible con rosca NPT (3145N).
 PN 10 - PN 8 - PN 6. Construcción en latón UNE-EN 12165. Cierre en NBR 65 sh. Extremos rosca gas (BSP) H - ISO 228/1. Temp. máx. 90°C.

Bottom valve

Also available NPT thread (3145N).
 PN 10 - PN 8 - PN 6. Body brass UNE-EN 12165. Rubber sealing guided seat. Gas threaded ends (BSP) F - ISO 228/1. Max. temp. 90°C.

R	PN	P	B	A
3/4"	10	20	45,5	73
1"	10	25	52	81
1 1/4"	8	32	61,5	93,5
1 1/2"	8	40	68,5	102,5
2"	8	50	80	116,5
2 1/2"	6	65	103	136
3"	6	80	116,5	149,5
4"	6	100	145,5	187

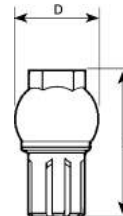

CÓDIGO CODE	MEDIDA SIZE	PESO WEIGHT	CAJA / BOX CARTON	P.V.P. € PRICE €
3145 05	3/4"	0,213	20-160	-
3145 06	1"	0,280	15-120	-
3145 07	1 1/4"	0,425	6-72	-
3145 08	1 1/2"	0,578	5-60	-
3145 09	2"	0,815	4-32	-
3145 10	2 1/2"	1,320	1-24	-
3145 11	3"	1,670	1-18	-
3145 12	4"	3,075	1-8	-

Precios rosca NPT a consultar / NPT thread prices on request

Ref. 3850



Anticalcáreo magnético "Calcolit"

PN 16. Construcción en latón UNE-EN 12165 cromado. Extremos rosca gas (BSP) M-M - ISO 228/1. Temp. máx. 80°C.

"Calcolit" magnetic limestone reducer

PN 16. Chrome plated brass UNE-EN 12165. Gas threaded ends M-M - ISO 228/1. Max. temp. 80°C.

R	A	B
1/2"	56	104
3/4"	56	106
1"	65	128
1 1/4"	79	141
1 1/2"	110	203
2"	110	203

CÓDIGO CODE	MEDIDA SIZE	PESO WEIGHT	CAJA / BOX CARTON	P.V.P. € PRICE €
3850 04	1/2"	0,675	1-40	-
3850 05	3/4"	0,696	1-40	-
3850 06	1"	1,140	1-1	-
3850 07	1 1/4"	1,273	1-1	-
3850 08	1 1/2"	2,239	1-1	-
3850 09	2"	2,338	1-1	-

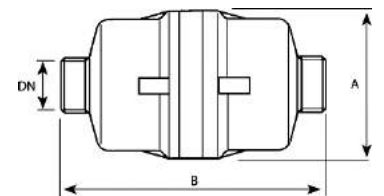

Ref. 3180 - 3180N



Válvula de retención clapeta goma

También disponible con rosca NPT (3180N).
 PN 12/8. Construcción en latón UNE-EN 12165. Cierre NBR (goma) 65 sh. Extremos rosca gas (BSP) H-H - ISO 228/1. Temp. máx. 100°C. Montaje en horizontal.

Rubber swing check valve

Also available NPT thread (3180N).
 PN 12/8. Body brass UNE-EN 12165. Rubber sealing. Gas threaded ends (BSP) F-F - ISO 228/1. Max. temp. 100°C. Horizontal assembling.

R	P	A	L	PN
1/2"	15	46,5	47	12
3/4"	20	54,5	52	12
1"	25	61,5	64,5	12
1 1/4"	30	72	74	10
1 1/2"	35	84	86	10
2"	45	94	97	10
2 1/2"	57	108	116,5	8
3"	60	130	137	8
4"	90	165	163	8

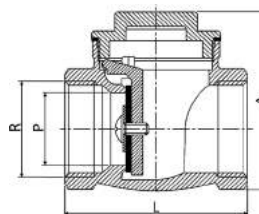

CÓDIGO CODE	MEDIDA SIZE	PESO WEIGHT	CAJA / BOX CARTON	P.V.P. € PRICE €
3180 04	1/2"	0,164	20-160	-
3180 05	3/4"	0,221	12-96	-
3180 06	1"	0,334	10-80	-
3180 07	1 1/4"	0,442	8-64	-
3180 08	1 1/2"	0,713	5-40	-
3180 09	2"	1,016	3-30	-
3180 10	2 1/2"	1,551	1-25	-
3180 11	3"	2,451	1-16	-
3180 12	4"	3,950	1-8	-

Precios rosca NPT a consultar / NPT thread prices on request

Ref. 3185 - 3185N



Válvula de retención clapeta metal

También disponible con rosca NPT (3185N).
PN 12/8. Cierre metálico. Construcción en latón UNE-EN 12165. Extremos rosca gas (BSP) H-H - ISO 228/1. Temp. máx. 200°C. Montaje en horizontal.

Metal swing check valve

Also available NPT thread (3185N).
PN 12/8. Metal sealing. Body brass UNE-EN 12165. Gas threaded ends (BSP) F-F - ISO 228/1. Max. temp. 200°C. Horizontal assembling.

R	P	A	L	PN
1/2"	15	46,5	47	12
3/4"	20	54,5	52	12
1"	25	61,5	64,5	12
1 1/4"	30	72	74	10
1 1/2"	35	84,5	86	10
2"	45	94	97	10
2 1/2"	57	107	116,5	8
3"	60	130,5	137	8
4"	90	140,5	161	8

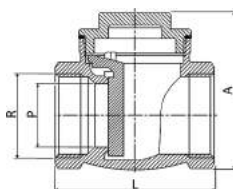

CÓDIGO CODE	MEDIDA SIZE	PESO WEIGHT	CAJA / BOX CARTON	P.V.P. € PRICE €
3185 04	1/2"	0,152	20-160	-
3185 05	3/4"	0,217	12-96	-
3185 06	1"	0,328	10-80	-
3185 07	1 1/4"	0,455	8-64	-
3185 08	1 1/2"	0,698	5-40	-
3185 09	2"	1,051	3-30	-
3185 10	2 1/2"	1,592	1-25	-
3185 11	3"	2,465	1-16	-
3185 12	4"	3,800	1-8	-

Precios rosca NPT a consultar / NPT thread prices on request

Ref. 3186



Válvula de retención clapeta PTFE

PN 16. Cierre en PTFE. Construcción en Bronce UNE-EN 1982 - Latón UNE-EN 12165. Extremos rosca gas (BSP) H-H - ISO 228/1. Temp. máx. 180°C.

PTFE swing check valve

PN 16. PTFE sealing. Construction Bronze UNE-EN 1982 - Brass UNE-EN 12165. Gas threaded end (BSP) F-F - ISO 228/1. Max. Temp. 180°C.

R	L	A
1/2"	60	38
3/4"	70	49
1"	80	55
1 1/4"	95	59
1 1/2"	105	69
2"	130	78

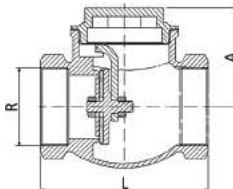

CÓDIGO CODE	MEDIDA SIZE	PESO WEIGHT	CAJA / BOX CARTON	P.V.P. € PRICE €
3186 04	1/2"	0,370	-	-
3186 05	3/4"	0,430	-	-
3186 06	1"	0,645	-	-
3186 07	1 1/4"	0,810	-	-
3186 08	1 1/2"	1,050	-	-
3186 09	2"	1,500	-	-

Precios rosca NPT a consultar / NPT thread prices on request

Ref. 3187



Válvula de retención cierre PTFE

PN 16. Cierre en PTFE. Construcción en Bronce UNE-EN 1982 - Latón UNE-EN 12165. Muelle en acero inoxidable. Extremos rosca gas (BSP) H-H - ISO 228/1. Temp. máx. 180°C.

PTFE sealing check valve

PN 16. PTFE sealing. Construction Bronze UNE-EN 1982 - Brass UNE-EN 12165. Stainless steel spring. Gas threaded end (BSP) F-F - ISO 228/1. Max. Temp. 180°C.

R	L	A
3/8"	45	38
1/2"	50	39
3/4"	61	48
1"	71	53
1 1/4"	85	56
1 1/2"	90	63
2"	110	72

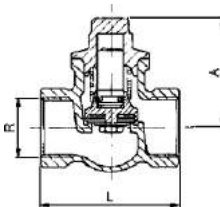

CÓDIGO CODE	MEDIDA SIZE	PESO WEIGHT	CAJA / BOX CARTON	P.V.P. € PRICE €
3187 03	3/8"	0,145	20-120	-
3187 04	1/2"	0,205	20-120	-
3187 05	3/4"	0,340	10-60	-
3187 06	1"	0,460	6-36	-
3187 07	1 1/4"	0,769	4-24	-
3187 08	1 1/2"	0,990	4-24	-
3187 09	2"	1,640	2-12	-

Ref. 3190 - 3190N



Válvula de alivio de presión con escape conducido

También disponible con rosca NPT (3190N).
PN 16. Cierre PTFE. Construcción en latón UNE-EN 12165. Muelle en acero galvanizado. Regulación de: 0 - 10 bar (3/8" - 3") y de 5 - 10 bar (4"). Extremos en escuadra rosca gas (BSP) H-H - ISO 228/1. Temp. -10°C +180°C.

Pressure relief valve with conveyed discharge

Also available NPT thread (3190N).
PN 16. PTFE sealing. Body brass UNE-EN 12165. Galvanized steel spring. Adjustable: from 0 - 10 bar (3/8" to 3") and 5 - 10 bar (4"). Gas threaded end (BSP) F-F - ISO 228/1. Working temperature: -10°C +180°C.

R	DN	L	L1	H
3/8"	10	45	24,5	115
1/2"	15	56	30	122
3/4"	20	64	32	149
1"	25	76	40	163
1 1/4"	32	90	44	192
1 1/2"	40	100	47	218
2"	50	124	60	247
2 1/2"	65	148	85	295
3"	80	157	88	330
4"	100	175	95	385

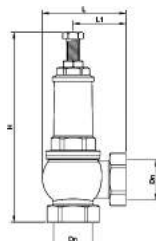

CÓDIGO CODE	MEDIDA SIZE	PESO WEIGHT	CAJA / BOX CARTON	P.V.P. € PRICE €
3190 03	3/8"	0,300	10-80	-
3190 04	1/2"	0,440	10-80	-
3190 05	3/4"	0,638	6-48	-
3190 06	1"	1,025	4-32	-
3190 07	1 1/4"	1,630	3-18	-
3190 08	1 1/2"	2,010	2-12	-
3190 09	2"	3,140	1-6	-
3190 10	2 1/2"	5,900	1-4	-
3190 11	3"	7,000	1-3	-
3190 12	4"	14,850	1-1	-

Ref. 3193



Válvula de alivio de presión

PN 16. Construcción en latón UNE-EN 12165 cromado. Extremos rosca M-H, ISO 228/1. Muelles acero inox. Taraje estándar fijo a 8 bar. Cierre NBR. Temperatura máxima 110°C.

Pressure relief valve

PN 16. Body chrome plated brass UNE-EN 12165. Threaded end M-F, ISO 228/1. Stainless steel springs. Standard tare 8 bar. NBR sealing. Maximum temperature 110°C.

R	P	A	B
1/2"	10,5	40	52
3/4"	10,5	54	55

CÓDIGO CODE	MEDIDA SIZE	PESO WEIGHT	CAJA / BOX CARTON	P.V.P. € PRICE €
3193 04	1/2"	0,065	20-360	-
3193 05	3/4"	0,130	10-180	-

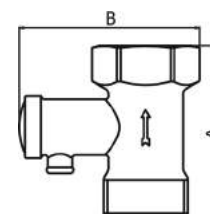

Ref. 3194



Válvula de alivio de presión

Con dispositivo de descarga manual por palanca. PN 16. Construcción en latón UNE-EN 12165 cromado. Extremos rosca M-H, ISO 228/1. Muelles acero inox. Taraje estándar fijo a 8 bar. Cierre NBR. Temperatura máxima 110°C.

Pressure relief valve

Safety check valve with manual unloading device by lever. PN 16. Body chrome plated brass UNE-EN 12165. Threaded end M-F, ISO 228/1. Stainless steel springs. Standard tare 8 bar. NBR sealing. Maximum temperature 110°C.

R	P	A	B
1/2"	10,5	40	62
3/4"	10,5	54	65

CÓDIGO CODE	MEDIDA SIZE	PESO WEIGHT	CAJA / BOX CARTON	P.V.P. € PRICE €
3194 04	1/2"	0,068	20-360	-
3194 05	3/4"	0,132	10-180	-

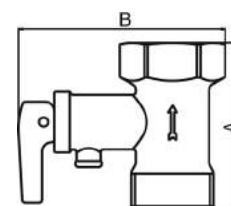

Ref. 3860

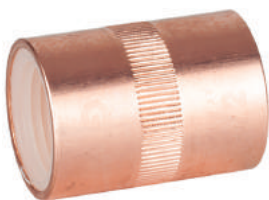

Manguito antielectrólisis

PN 10. Construcción en poliamida 6 (nylon). Funda de cobre. Extremos rosca gas (BSP) H -H - ISO 228/1. Temp. máx. 90°C aire - 80°C agua.

Anti-electrolysis fitting

PN 10. Body nylon. Copper cover. Gas threaded ends (BSP) F-F - ISO 228/1. Max. temp. 90°C air - 80°C water.

R	P	A	L
1/2"	14	28	39
3/4"	20	35	38
1"	25	42	43
1 1/4"	32	54	58
1 1/2"	40	62	59
2"	50	80	75
2 1/2"	65	92	87
3"	80	105	96
4"	100	130	103

3860 04	1/2"	0,039	48-864	-
3860 05	3/4"	0,050	30-540	-
3860 06	1"	0,073	20-360	-
3860 07	1 1/4"	0,162	6-108	-
3860 08	1 1/2"	0,187	4-72	-
3860 09	2"	0,459	2-36	-
3860 10	2 1/2"	0,610	2-36	-
3860 12	4"	1,458	1-18	-

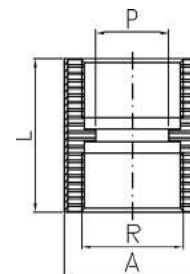

Ref. 3865



Manguito antielectrólisis

PN 10. Construcción en poliamida 6 (nylon). Funda de cobre. Extremos rosca gas (BSP) M -H - ISO 228/1. Temp. máx. 90°C aire - 80°C agua.

Anti-electrolysis fitting

PN 10. Body nylon. Copper cover. Gas threaded ends (BSP) M-F - ISO 228/1. Max. temp. 90°C air - 80°C water.

R	P	A	L
1/2"	15	28	41
3/4"	19	35	42

3865 04	1/2"	0,025	48-864	-
3865 05	3/4"	0,041	30-540	-

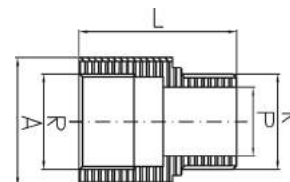

Ref. 3228



Válvula de asiento de globo
 PN 16. Cierre en PTFE. Construcción en Bronce UNE-EN 1982 - Latón UNE-EN 12165. Extremos rosca gas (BSP) H-H - ISO 228/1. Temp. máx. 180°C. Volante de aluminio.

Globe valve
 PN 16. PTFE sealing. Construction Bronze UNE-EN 1982 - Brass UNE-EN 12165. Gas threaded end (BSP) F-F - ISO 228/1. Max. Temp. 180°C. Aluminium wheel.

R	L	A	M
3/8"	45	67	50
1/2"	50	80	50
3/4"	62	85	50
1"	71	94	60
1 1/4"	85	106	70
1 1/2"	90	118	80
2"	110	127	80

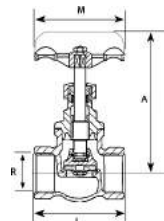

CÓDIGO CODE	MEDIDA SIZE	PESO WEIGHT	CAJA / BOX CARTON	P.V.P. € PRICE €
3228 03	3/8"	0,180	10-60	-
3228 04	1/2"	0,265	10-80	-
3228 05	3/4"	0,400	8-64	-
3228 06	1"	0,550	4-32	-
3228 07	1 1/4"	0,876	2-16	-
3228 08	1 1/2"	1,135	2-16	-
3228 09	2"	1,790	1-6	-

Ref. 3227

NEW



Válvula globo de bronce con retención y eje libre
 PN 20. Paso reducido. Construcción en bronce UNE-EN 1982 - Latón UNE-EN 12165. Cierre NBR. Extremos rosca gas (BSP) H-H - ISO 228/1. Temperatura máxima de trabajo 100°C. Volante de aluminio.

Globe bronze loose-jumper stop valve
 PN 20. Reduced bore. Bronze construction UNE-EN 1982 - Brass UNE-EN 12165. NBR seal. Gas threaded ends (BSP) F-F-ISO 228/1. Maximum working temperature 100°C. Aluminium wheel.

R	PN	P	A	L	M
3/4"	20	19	81	68	64
1"	20	25	83	101	64
1 1/4"	20	31,5	100	89	74
1 1/2"	20	38	115	101	80

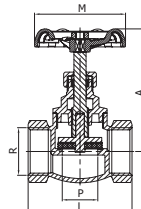

3227 05	3/4"	0,420	-	-
3227 06	1"	0,525	-	-
3227 07	1 1/4"	0,900	-	-
3227 08	1 1/2"	1,335	-	-

Ref. 3229

NEW



Válvula de compuerta de bronce
 PN 20. Paso reducido. Construcción en bronce UNE-EN 1982. Latón UNE-EN 12165. Extremos rosca gas (BSP) H-H - ISO 228/1. Temperatura máxima de trabajo 180°C. Volante de aluminio.

Bronze gate valve
 PN 20. Reduced bore. Bronze construction UNE-EN 1982. brass UNE-EN 12165. Gas threaded ends (BSP) F-F-ISO 228/1. Maximum working temperature 180°C. Aluminium wheel.

R	PN	P	A	L	M
1/2"	20	14	76	49	54
3/4"	20	18	89	52	60
1"	20	23	100	60	64
1 1/4"	20	32	109	62	74
1 1/2"	20	35	125	66	80
2"	20	45	150	70	88
2 1/2"	20	58	188	88	110

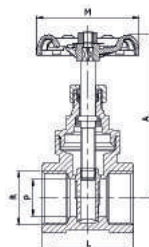

3229 04	1/4"	0,250	-	-
3229 05	3/4"	0,330	-	-
3229 06	1"	0,530	-	-
3229 07	1 1/4"	0,750	-	-
3229 08	1 1/2"	1,000	-	-
3229 09	2"	1,560	-	-
3229 10	2 1/2"	2,970	-	-

Ref. 3220 - 3222



Válvula de compuerta latón
 También disponible con rosca NPT (3222).
 PN 16. Paso reducido. Construcción en latón UNE-EN 12165. Temp. máx. 110°C. Extremos rosca gas (BSP) H-H - ISO 228/1.

Brass gate valve
 Also available NPT thread (3222).
 PN 16. Reduce bore. Body brass UNE-EN 12165. Max. temp. 110°C. Gas threaded ends (BSP) F-F - ISO 228/1.

R	PN	P	A	L	M
1/2"	16	13	62	36,8	51
3/4"	16	15	66	42,5	55,8
1"	16	19	73	45,8	60
1 1/4"	16	27	91	50,8	60,6
1 1/2"	16	33	98	54	70,8
2"	16	42	127	62,8	92
2 1/2"	16	57	160	68	100
3"	16	60	190	83	110
4"	16	91	238	92	132

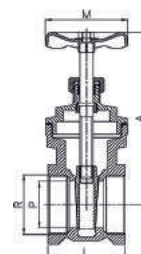

3220 04	1/2"	0,158	16-80	-
3220 05	3/4"	0,206	12-60	-
3220 06	1"	0,291	8-48	-
3220 07	1 1/4"	0,436	6-36	-
3220 08	1 1/2"	0,602	4-48	-
3220 09	2"	1,056	2-24	-
3220 10	2 1/2"	1,890	1-12	-
3220 11	3"	2,526	1-8	-
3220 12	4"	4,518	1-4	-

Precios rosca NPT a consultar / NPT thread prices on request

Ref. 3221 - 3221N



Válvula de compuerta latón

También disponible con rosca NPT (3221N).
PN 20. Paso estándar. Construcción en latón según UNE-EN 12165.
Temp. máx. 180°C. Extremos rosca gas (BSP) H-H - ISO 228/1.
Volante aluminio.

Brass gate valve

Also available NPT thread (3221N).
PN 20. Standard bore. Brass construction UNE-EN 12165. Max. temp.
180°C. Gas threaded ends (BSP) F-F - ISO 228/1. Aluminium wheel.

R	PN	P	A	L	M
1/2"	20	14	76	45,5	54
3/4"	20	20	87	49,3	60
1"	20	25	98	56	64
1 1/4"	20	32	110	60	74
1 1/2"	20	37	124	65	80
2"	20	47	74	74	90
2 1/2"	20	59	180	81	110
3"	20	70	201	83	110
4"	20	92	248	102	140

CÓDIGO CODE	MEDIDA SIZE	PESO WEIGHT	CAJA / BOX CARTON	P.V.P. € PRICE €
3221 04	1/2"	0,245	10-100	-
3221 05	3/4"	0,355	8-48	-
3221 06	1"	0,501	5-50	-
3221 07	1 1/4"	0,732	4-24	-
3221 08	1 1/2"	0,963	2-24	-
3221 09	2"	1,409	2-16	-
3221 10	2 1/2"	2,375	1-6	-
3221 11	3"	3,114	1-6	-
3221 12	4"	5,531	1-4	-

Precios rosca NPT a consultar / NPT thread prices on request

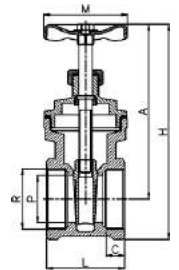

Ref. 3230



Válvula de asiento inclinado

PN 16. Paso total. Construcción en latón UNE-EN 12165. Cierre EPDM. Temp. máx. 100°C. Extremos rosca gas (BSP) H-H - ISO 228/1.

Slanted seat valve

PN 16. Full bore. Body brass UNE-EN 12165. EPDM sealing. Max. temp. 100°C. Gas threaded ends (BSP) F-F - ISO 228/1.

R	DN	A	L
1/2"	15	66	57
3/4"	20	70	66
1"	25	97	80
1 1/4"	32	115	92
1 1/2"	40	131	101
2"	50	155	121
2 1/2"	65	225	151
3"	78	232	172
4"	98	320	219

CÓDIGO CODE	MEDIDA SIZE	PESO WEIGHT	CAJA / BOX CARTON	P.V.P. € PRICE €
3230 04	1/2"	0,185	10-80	-
3230 05	3/4"	0,265	6-48	-
3230 06	1"	0,505	5-30	-
3230 07	1 1/4"	0,865	2-16	-
3230 08	1 1/2"	1,025	1-8	-
3230 09	2"	1,720	1-6	-
3230 10	2 1/2"	3,450	1-5	-
3230 11	3"	4,900	1-4	-
3230 12	4"	9,900	1-2	-

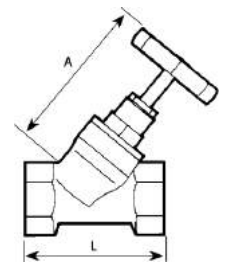

Ref. 3236



Válvula de compuerta para transformadores

Construcción en Bronce UNE-EN 1982 - Latón UNE-EN 12165.
Extremos Bridas EN 1092 PN 16. Con indicador de posición y dispositivo de bloqueo. Máxima presión de trabajo 6 bar.
Temperatura del fluido -40°C / +120°C.

Gate valve for transformers

Construction Bronze UNE-EN 1982 - Brass UNE-EN 12165. Flanged ends EN 1092 PN 16. With position indicator and locking device. Maximum working pressure 6 bar. Fluid temperature -40°C / +120°C.

ODN	A	B	C
15	95	77	130
25	115	77	150
32	140	86	185
40	150	120	200
50	165	135	220
80	200	185	290

CÓDIGO CODE	MEDIDA SIZE	PESO WEIGHT	CAJA / BOX CARTON	P.V.P. € PRICE €
3236 04	1/2"	1,500	-	-
3236 06	1"	2,875	-	-
3236 07	1 1/4"	4,300	-	-
3236 08	1 1/2"	5,000	-	-
3236 09	2"	7,000	-	-
3236 11	3"	12,000	-	-

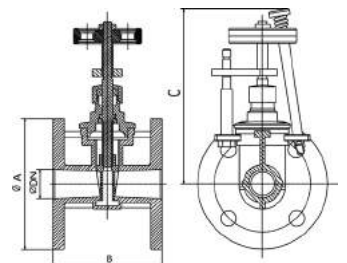

Ref. 3069



Válvula con filtro colador tipo "Y"

PN 16. Construcción en latón UNE-EN 12165. Extremos rosca gas (BSP) hembra. ISO 228/1. Tamiz: inox AISI 304. Luz: 400 micras. Temp. máx. 110°C.

Brass valve with type "Y" strainer filter

PN 16. Body chrome plated brass UNE-EN 12165. Gas threaded ends (BSP) F-F - ISO 228/1. Sieve: stainless steel AISI 304. Light: 400 microns. Max. temp. 110°C.

R	A	L	M
1/2"	66	78	52
3/4"	83	92	60
1"	98	112	68

CÓDIGO CODE	MEDIDA SIZE	PESO WEIGHT	CAJA / BOX CARTON	P.V.P. € PRICE €
3069 04	1/2"	0,245	6-108	-
3069 05	3/4"	0,407	4-72	-
3069 06	1"	0,580	2-36	-

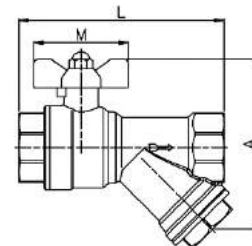

Ref. 3302 - 3302N



Filtro colador tipo "Y" latón

También disponible con rosca NPT (3302N). PN 16. Cuerpo latón UNE-EN 12165. Tamiz: inox. AISI 304. Junta tapa: NBR. Temp. máx. 100°C. Extremos rosca gas (BSP)

"Y" brass strainer

Also available NPT thread (3302N). PN 16. Body brass UNE-EN 12165. Sieve: stainless steel AISI 304. NBR joint. Max. temp. 100°C. Gas threaded ends (BSP) F-F - ISO 228/1.

R	H	L	Luz/Light (microns)
1/2"	38	56,5	500
3/4"	44	66	500
1"	50	74	500
1 1/4"	66	96	500
1 1/2"	71	104	500
2"	89	125	500
2 1/2"	110	154	1200
3"	120	173	1200
4"	152	210	1200

3302 04	1/2"	0,119	24-192	-
3302 05	3/4"	0,182	12-96	-
3302 06	1"	0,256	10-80	-
3302 07	1 1/4"	0,574	5-60	-
3302 08	1 1/2"	0,778	2-36	-
3302 09	2"	1,260	1-18	-
3302 10	2 1/2"	2,107	1-15	-
3302 11	3"	2,952	1-10	-
3302 12	4"	5,311	1-4	-

Precios rosca NPT a consultar / NPT thread prices on request

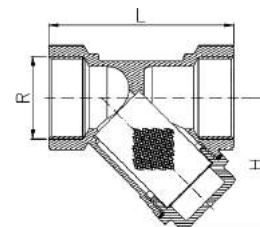

Ref. 3304



Filtro colador tipo "Y" bronce

Construcción en bronce según UNE-EN 1982. Latón UNE-EN 12165. Tamiz: inox. AISI 304. Temperatura de trabajo de -20°C a 110°C. Extremos rosca gas (BSP) H - H - ISO 228/1.

Bronze "Y" type strainer filter

Body bronze UNE-EN 1982. Brass UNE-EN 12165. Sieve: stainless steel AISI 304. Working temperature from -20°C to 110°C. Gas threaded ends (BSP) F-F - ISO 228/1.

R	PN (bar)	DN	H	L	Luz/Light (microns)
3/8"	16	12	40	55	400
1/2"	16	15	44	59	400
3/4"	16	20	50,5	69	400
1"	16	25	60	82	400
1 1/4"	16	32	73	98,5	500
1 1/2"	16	40	80	109	500
2"	16	50	98	131	500
2 1/2"	10	65	114	151	500
3"	10	78	130	172	500
4"	10	98	170	219	500

3304 03	3/8"	0,180	25-100	-
3304 04	1/2"	0,180	20-120	-
3304 05	3/4"	0,280	12-72	-
3304 06	1"	0,465	10-60	-
3304 07	1 1/4"	0,700	5-30	-
3304 08	1 1/2"	0,940	1-25	-
3304 09	2"	1,500	1-15	-
3304 10	2 1/2"	2,150	1-10	-
3304 11	3"	3,250	1-6	-
3304 12	4"	6,550	1-3	-

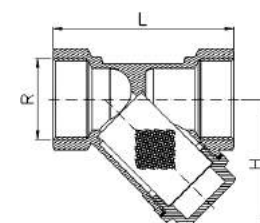

Ref. 3310



Filtro polivalente para agua
 PN 16. Construcción en latón UNE-EN 12165 cromado. Extremos rosca gas (BSP) H-H - ISO 228/1. Tamiz: acero inox. AISI 304. Luz: 800 micras. Junta tórica NBR. Temp. máx. 110°C.

In-line strainer for water
 PN 16. Body chrome plated brass UNE-EN 12165. Gas threaded ends (BSP) F-F - ISO 228/1. Sieve: stainless steel AISI 304. Light: 800 microns. NBR o-ring. Max. temp. 110°C.

R	D	L	M	A
1/2"	27	58	36	62
3/4"	33	74	43	76
1"	40	90	48	87
1 1/4"	49	115	56	105
1 1/2"	58	135	66	115
2"	71	161	80	135

CÓDIGO CODE	MEDIDA SIZE	PESO WEIGHT	CAJA / BOX CARTON	P.V.P. € PRICE €
3310 04	1/2"	0,130	8-128	-
3310 05	3/4"	0,220	8-80	-
3310 06	1"	0,350	6-54	-
3310 07	1 1/4"	0,655	5-30	-
3310 08	1 1/2"	0,980	2-12	-
3310 09	2"	1,530	1-10	-

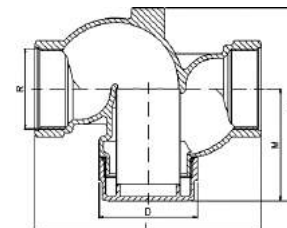

Ref. 3311



Filtro polivalente para gasoil
 PN 16. Cuerpo latón UNE-EN 12165 cromado. Extremos rosca gas (BSP) H-H - ISO 228/1. Tamiz: acero inox. AISI 304. Luz: 300 micras. Junta tórica NBR. Temp. máx. 110°C.

In-line strainer for diesel oil
 PN 16. Body chrome plated brass UNE-EN 12165. Gas threaded ends (BSP) F-F - ISO 228/1. Sieve: stainless steel AISI 304. Light: 300 microns. NBR o-ring. Max. temp. 110°C.

R	D	L	M	A
1/2"	27	58	36	62
3/4"	33	74	43	76
1"	40	90	48	87
1 1/4"	49	115	56	105
1 1/2"	58	135	66	115
2"	71	161	80	135

CÓDIGO CODE	MEDIDA SIZE	PESO WEIGHT	CAJA / BOX CARTON	P.V.P. € PRICE €
3311 04	1/2"	0,130	10-140	-
3311 05	3/4"	0,220	8-80	-
3311 06	1"	0,350	6-60	-
3311 07	1 1/4"	0,655	5-30	-
3311 08	1 1/2"	0,980	2-12	-
3311 09	2"	1,530	1-8	-

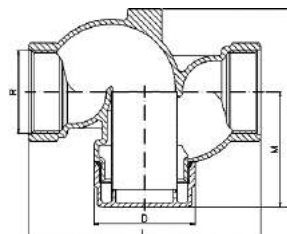

Ref. 3312



Filtro polivalente para gas
 PN 16. Cuerpo latón UNE-EN 12165 cromado. Extremos rosca gas (BSP) H-H - ISO 228/1. Tamiz: acero inox. AISI 304. Luz: 50 micras. Junta tórica NBR. Temp. máx. 110°C.

In-line strainer for gas
 PN 16. Body chrome plated brass UNE-EN 12165. Gas threaded ends (BSP) F-F - ISO 228/1. Sieve: stainless steel AISI 304. Light: 50 microns. NBR o-ring. Max. temp. 110°C.

R	D	L	M	A
1/2"	27	58	36	62
3/4"	33	74	43	76
1"	40	90	48	87
1 1/4"	49	115	56	105
1 1/2"	58	135	66	115
2"	71	161	80	135

CÓDIGO CODE	MEDIDA SIZE	PESO WEIGHT	CAJA / BOX CARTON	P.V.P. € PRICE €
3312 04	1/2"	0,130	10-160	-
3312 05	3/4"	0,220	8-80	-
3312 06	1"	0,350	6-60	-
3312 07	1 1/4"	0,655	5-30	-
3312 08	1 1/2"	0,980	2-12	-
3312 09	2"	1,530	1-8	-

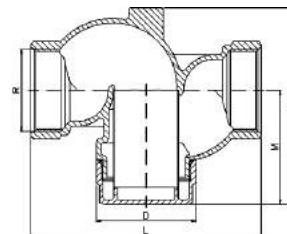

Ref. 3317

NEW



Amortiguador anti golpe de ariete "STOP-GE"
 PN 10. Construcción en latón niquelado UNE-EN 12165. Diafragma de EPDM peroxidado. Muelle en acero zincado EN 10270. Extremos rosca gas (BSP) M - ISO 228/1. Temperatura máxima de trabajo 90°C.

"STOP-GE" water hammer damper
 PN 10. Nickel plated brass construction UNE-EN 12165. EPDM perox diaphragm. Zinc plated steel spring EN 10270. Gas threaded ends (BSP) M -ISO 228/1. Maximum working temperarue 90°C.

R	A	B	C	H
1/2"	52	45	13,5	90

CÓDIGO CODE	MEDIDA SIZE	PESO WEIGHT	CAJA / BOX CARTON	P.V.P. € PRICE €
3317 04	1/2"	0,570	1-40	-

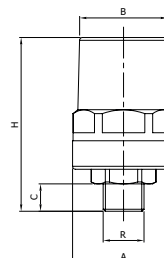

Ref. 3313



Filtro autolimpiante

PN 16. Construcción en latón UNE-EN 12165 cromado. Tamiz reforzado: acero inox. AISI 304. Luz: 500 micras. Junta NBR. Extremos rosca gas (BSP) H-H - ISO 228/1. Temp. máx. 110°C.

Self-cleaning filter

PN 16. Chrome plated brass construction UNE-EN 12165. Reinforced sieve: Stainless steel AISI 304. Light: 500 microns. NBR O-ring. Gas threaded ends (BSP) M-M - ISO 228/1. Max. temp. 110°C.

R	A	L	M
1/2"	189	58	49
3/4"	197	74	56
1"	208	90	61

CÓDIGO CODE	MEDIDA SIZE	PESO WEIGHT	CAJA / BOX CARTON	P.V.P. € PRICE €
-------------	-------------	-------------	-------------------	------------------

3313 04	1/2"	0,334	1-40	-
3313 05	3/4"	0,423	1-30	-
3313 06	1"	0,559	1-24	-

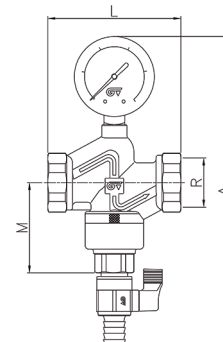

Ref. 3314



Filtro autolimpiante largo

PN 16. Construcción en latón UNE-EN 12165 cromado. Tamiz reforzado: acero inox. AISI 304. Luz: 500 micras. Junta NBR. Extremos rosca gas (BSP) H-H - ISO 228/1. Temp. máx. 110°C.

Long self-cleaning filter

PN 16. Chrome plated brass construction UNE-EN 12165. Reinforced sieve: Stainless steel AISI 304. Light: 500 microns. NBR O-ring. Gas threaded ends (BSP) M-M - ISO 228/1. Max. temp. 110°C.

R	A	L	M
1/2"	212	58	78
3/4"	226	74	84
1"	239	90	92
1 1/4"	265	115	102
1 1/2"	278	135	116
2"	303	161	134

3314 04	1/2"	0,380	1-40	-
3314 05	3/4"	0,484	1-30	-
3314 06	1"	0,650	1-24	-
3314 07	1 1/4"	1,013	1-18	-
3314 08	1 1/2"	1,435	1-12	-
3314 09	2"	2,103	1-6	-

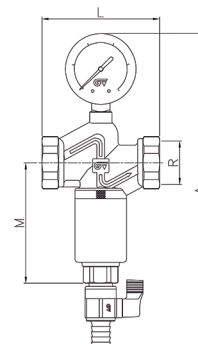

Ref. 3316



Filtro autolimpiante

PN 16. Construcción en latón níquelado. Tamiz: acero inox. AISI 304. Luz: 100 micras. Extremos rosca gas (BSP) M-M - ISO 228/1. Con dos manómetros y válvula de vaciado. Máx. temperatura 100°C.

Self-cleaning filter

PN 16. Nickel plated brass construction. Sieve: Stainless steel AISI 304. Light: 100 micron. Gas thread ends (BSP) M-M - ISO 228/1. With double pressure gauge and discharge valve. Max. temperature 100°C.

R	A	B
1/2"	257	145
3/4"	257	155
1"	267	164

3316 04	1/2"	0,940	1	-
3316 05	3/4"	1,110	1	-
3316 06	1"	1,585	1	-

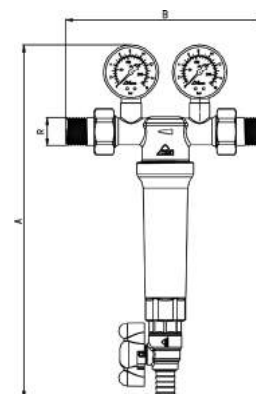

Ref. 3318 - 3318N



Válvula reductora de presión Redux-Ge a pistón

También disponible con rosca NPT (3318N).
PN 25. Construcción en latón UNE-EN 12165 cromado. Cierre acero inox. AISI 303. Muelle en acero zincado EN-10270. Juntas EPDM perox. Extremos rosca gas (BSP) H-H - ISO 228/1. Temp. máx. trabajo 130°C.

Redux-GE piston pressure reducer valve

Also available NPT thread (3318N).
PN 25. Chrome plated brass construction UNE-EN 12165. AISI 303 stainless steel sealing. Zinc plated steel spring EN-10270. EPDM perox joints. Gas threaded ends (BSP) F-F - ISO 228/1. Max. working temp. 130°C.

R	A	ØB	C	L	Presión salida / Output pressure	
					Min.	Max.
1/2"	114,5	48	63,5	69,5	0,5	5,5
3/4"	114,5	48	63,5	82	0,5	5,5
1"	146	59	73,5	96	0,5	5,5
1 1/4"	152	59	73,5	100	0,5	6
1 1/2"	148,5	59	77	97	0,5	6
2"	150,5	59	81	97	0,5	6
2 1/2"	263,5	76	112	147	1	7
3"	285	82,5	112	179	1	7
4"	325	88,5	124	189	1	7

CÓDIGO CODE	MEDIDA SIZE	PESO WEIGHT	CAJA / BOX CARTON	P.V.P. € PRICE €
3318 04	1/2"	0,570	1-40	-
3318 05	3/4"	0,600	1-40	-
3318 06	1"	0,985	1-20	-
3318 07	1 1/4"	1,180	1-20	-
3318 08	1 1/2"	1,500	1-20	-
3318 09	2"	1,650	1-20	-
3318 10	2 1/2"	3,990	1-6	-
3318 11	3"	5,500	1-3	-
3318 12	4"	7,300	1-2	-

Precios rosca NPT a consultar / NPT thread prices on request

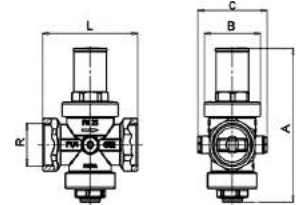

Ref. 3320E



Válvula reductora de presión a pistón "Rinoxdos"

PN25. Cuerpo en latón níquelado UNE-EN 12165. Cierre inox AISI 304 y goma EPDM . Muelle en acero galvanizado. Juntas tóricas en EPDM. Extremos rosca gas (BSP) H-H ISO 228/1. Campo de regulación 0,5 a 6 bar. Presión salida establecida 3 bar.

"Rinoxdos" pressure reducer piston valve

PN 25. Body nickel-plated brass UNE-EN 12165. Sealing inox AISI 304 and EPDM rubber. Galvanized steel spring. EPDM o-rings. Gas threaded ends (BSP) F-F ISO 228/1. Adjustable range from 0,5 to 6 bar. Outlet setting pressure 3 bar.

R	A	B	C	L	Presión salida (bar)/Output pressure (bar) Min.	Presión salida (bar)/Output pressure (bar) Max.
1/2"	100	65	32	69	0,5	6
3/4"	100	65	32	82	0,5	6

CÓDIGO CODE	MEDIDA SIZE	PESO WEIGHT	CAJA / BOX CARTON	P.V.P. € PRICE €
3320E 04	1/2"	0,542	1-24	-
3320E 05	3/4"	0,572	1-24	-

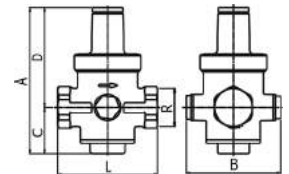

Ref. 3320



Válvula reductora de presión "Rinoxdue" a pistón

PN25. Cuerpo latón UNE-EN 12165 cromado. Cierre inox AISI 303. Juntas tóricas NBR. Extremos rosca gas (BSP) H-H ISO 228/1. Campo de regulación 0,5 a 7 bar. Presión salida establecida 3 bar.

"Rinoxdue" piston pressure reducer valve

PN 25. Body chrome plated brass UNE-EN 12165. Sealing inox AISI 303. Gas threaded ends (BSP) F-F ISO 228/1. Adjustable range from 0,5 to 7 bar. Outlet setting pressure 3 bar.

R	A	L	P	Presión salida / Output pressure	
				Min.	Max.
1/2"	110	60	69	0,5	4
3/4"	110	60	69	0,5	4
1"	152	86	92	0,5	7
1 1/4"	158	91	93	0,5	7
1 1/2"	163	91	98	0,5	7
2"	171	91	101	0,5	7

CÓDIGO CODE	MEDIDA SIZE	PESO WEIGHT	CAJA / BOX CARTON	P.V.P. € PRICE €
3320 04	1/2"	0,550	1-40	-
3320 05	3/4"	0,550	1-40	-
3320 06	1"	1,110	1-20	-
3320 07	1 1/4"	1,340	1-25	-
3320 08	1 1/2"	1,450	1-25	-
3320 09	2"	1,550	1-25	-

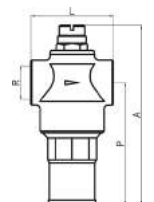

Ref. 3340



Válvula reductora de presión "Rinox" a membrana

PN 40. Caudal total. Cuerpo latón UNE-EN 12165 cromado. Cierre acero inox AISI 304. Muelle en acero al silicio zincado. Membrana y juntas tóricas: NBR. Presión entrada máx. 16 bar. Extremos rosca gas (BSP) H-H - ISO 228/1

"Rinox" membrane pressure reducer valve

PN 40. Full flow. Body chrome plated brass UNE-EN 12165. Sealing inox AISI 304. Zinc plated silicone steel spring o-ring NBR. Membrane: reinforced EPDM. Max. input pressure 16 bar. Gas threaded ends (BSP) F-F - ISO 228/1.

R	A	L	P	PN	Presión salida / Output pressure	
					Min.	Max.
1/2"	135	76,5	83	40	0,8	5,5
3/4"	135	76,5	83	40	0,8	5,5
1"	198	95	135	40	0,8	5,5
1 1/4"	220	116	153	40	0,8	7
1 1/2"	235	122	163	40	0,8	7
2"	235	126	163	40	0,8	7
2 1/2"	390	180	290	40	0,8	7
3"	390	188	290	40	0,8	7
4"	390	202	290	40	0,8	7

CÓDIGO CODE	MEDIDA SIZE	PESO WEIGHT	CAJA / BOX CARTON	P.V.P. € PRICE €
3340 04	1/2"	1,400	1-12	-
3340 05	3/4"	1,400	1-20	-
3340 06	1"	1,600	1-12	-
3340 07	1 1/4"	2,340	1-13	-
3340 08	1 1/2"	3,000	1-10	-
3340 09	2"	3,200	1-10	-
3340 10	2 1/2"	12,900	1-1	-
3340 11	3"	13,100	1-1	-
3340 12	4"	14,000	1-1	-

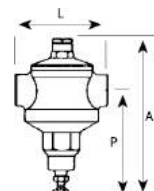

Ref. 3324



Válvula reductora de presión a membrana con filtro
 PN 16. Cuerpo en latón niquelado UNE-EN 12165. Membrana en NBR. Filtro en acero inox AISI 302, 800 micras. Juntas en NBR. Extremos rosca gas (BSP) H-H ISO 228/1. Temperatura máx. de trabajo 80°C. Presión máxima entrada 16 bar. Campo de regulación 0,5 a 7 bar. Presión de salida establecida 3 bar.

Membrane pressure reducer valve with filter
 PN 16. Body nickel-plated brass UNE-EN 12165. Membrane NBR. Filter stainless steel AISI 302, 800 microns. O-rings NBR. Gas threaded ends (BSP) F-F ISO 228/1. Max. working temperature 80°C. Max. inlet pressure 16 bar. Adjustable range from 0,5 to 7 bar. Outlet setting pressure 3 bar.

R	A	B	C	Ø D	Presión salida / Output pressure	
					Min.	Max.
1/2"	75	17	108	46	0,5	7
3/4"	78	19	111	46	0,5	7

CÓDIGO CODE	MEDIDA SIZE	PESO WEIGHT	CAJA / BOX CARTON	P.V.P. € PRICE €
3324 04	1/2"	0,45	1-9	-
3324 05	3/4"	0,5	1-9	-

Precios a consultar / Prices on request

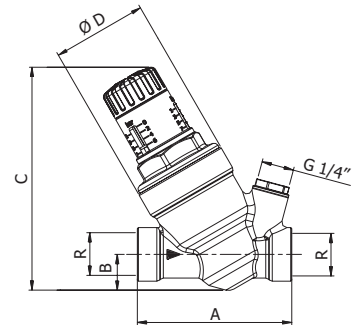

Ref. 3324R



Válvula reductora de presión a membrana con racord y filtro
 PN 16. Cuerpo en latón niquelado UNE-EN 12165. Membrana en NBR. Filtro en acero inox AISI 302, 800 micras. Juntas en NBR. Extremos rosca gas con racores (BSP) M-M ISO 228/1. Temperatura máx. trabajo 80°C. Presión máxima entrada 16 bar. Campo de regulación 0,5 a 7 bar. Presión de salida establecida 3 bar.

Membrane pressure reducer valve with connectors and filter
 PN 16. Body nickel-plated brass UNE-EN 12165. Membrane NBR. Filter stainless steel AISI 302, 800 microns. O-rings NBR. Gas threaded ends with connectors (BSP) M-M ISO 228/1. Max. working temperature 80°C. Max. inlet pressure 16 bar. Adjustable range from 0,5 to 7 bar. Outlet setting pressure 3 bar.

R	A	B	C	D	Presión salida / Output pressure	
					Min.	Max.
1/2"	149	17	108	46	0,5	7
3/4"	160	19	111	46	0,5	7
1"	199	24	158	61	0,5	7
1 1/4"	217	30	168	61	0,5	7
1 1/2"	236	37	181	61	0,5	7
2"	269	47	193	61	0,5	7

3324R 04	1/2"	0,598	1-9	-
3324R 05	3/4"	0,722	1-9	-
3324R 06	1"	1,295	1-7	-
3324R 07	1 1/4"	1,95	1-7	-
3324R 08	1 1/2"	2,490	1-4	-
3324R 09	2"	3,690	1-4	-

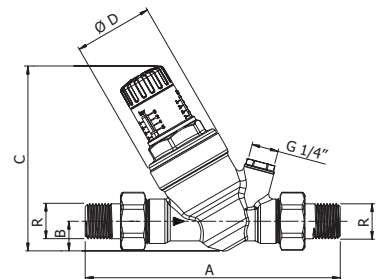

Ref. 2272



Válvula reductora de presión
 Construcción: acero inox. CF8M (316) microfundición. Extremos rosca gas ISO 7-1 (EN 10226-1). Asiento y diafragma FPM (Viton). Presión máxima de entrada 25 bar. Presión de salida: 1 – 6 bar (tarado a 3 bar). Temperatura de trabajo: -15°C +120°C.

Stainless steel pressure reducing valve
 Construction: stainless steel CF8M (316) investment casting. Gas threaded ends ISO 7-1 (EN 10226-1). Seat and diaphragm in FPM (viton). Maxim input pressure 25 bar. Outlet pressure: 1 – 6 bar (preset 3 bar). Working temperature: -15°C +120°C.

DN	R	H	L
15	1/2"	100	70
20	3/4"	100	85
25	1"	105	92

2272 04	1/2"	0,775	1-20	-
2272 05	3/4"	0,890	1-20	-
2272 06	1"	1,160	1-15	-

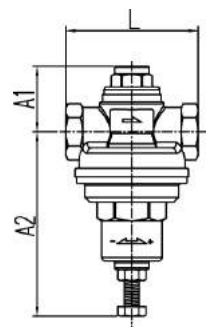

Ref. 3342

NEW



Válvula reductora de presión a membrana
 PN 25. Construcción en latón s/UNE-EN 12165. Membrana en EPDM reforzada en poliamida. Filtro en acero inox AISI 304, 500 micras. Juntas de EPDM. Muelle de acero galvanizado. Extremos rosca con racores M-M conico s/ EN 10226. Temperatura máx. de trabajo 80°C. Presión máx. de trabajo 25 bar. Campo de regulación 1 a 6 bar. Presión de salida establecida 3 bar.

Membrane pressure reducer valve
 PN 25. Brass construction UNE-EN 12165. EPDM membrane with polyamide reinforced. Filter stainless steel AISI 304, 500 microns. EPDM joints. Steel galvanized spring. Threaded ends with taper connectors M-M EN 10226. Max. working temp. 80°C. Max. working pressure 25 bar. Adjustable range from 1 to 6 bar. Outlet setting pressure 3 bar.

R	A	B	C	L	Presión salida (bar) / Output pressure (bar)	
					Min.	Max.
1/2"	140	42	149,3	84	1	6
3/4"	160	42	149,3	90	1	6
1"	199	55,2	180,5	100	1	6
1 1/4"	170	55,2	188,4	108	1	6
1 1/2"	199	70	239,3	134	1	6
2"	193	70	245,8	142	1	6

CÓDIGO CODE	MEDIDA SIZE	PESO WEIGHT	CAJA / BOX CARTON	P.V.P. € PRICE €
3342 04	1/2"	0,770	-	-
3342 05	3/4"	0,970	-	-
3342 06	1"	1,595	-	-
3342 07	1 1/4"	1,830	-	-
3342 08	1 1/2"	3,080	1-1	-
3342 09	2"	4,250	-	-

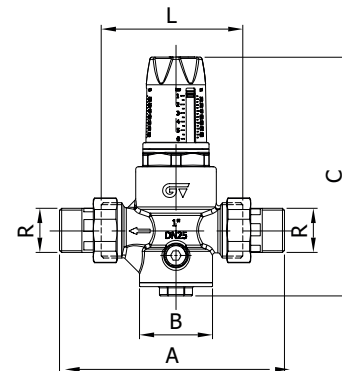

Ref. 3344



Válvula reductora de presión a pistón con bridas
 Bridas DIN PN 10/16. Cuerpo aleación de bronce UNI EN 1982. Cierre inox. AISI 303. Juntas tóricas: NBR. Máxima presión de entrada 30 bar. Máx. temperatura de trabajo 80°C. Rango de salida ajustable de 1,5 a 7 bar.

Direct acting piston flanged ends pressure reducing valve
 Flanged DIN PN 10/16. Bronze alloy body UNI EN 1982. Sealing inox. AISI 303. O'rings NBR. Maximum inlet pressure 30 bar. Maximum working temperature 80°C. Outlet range: adjustable from 1,5 to 7 bar.

DN	L	H
50	165	250
65	170	260
80	177	270

3344 09	2"	10,700	1-2	-
3344 10	2 1/2"	11,200	1-2	-
3344 11	3"	12,500	1-2	-

*Bajo demanda / On request

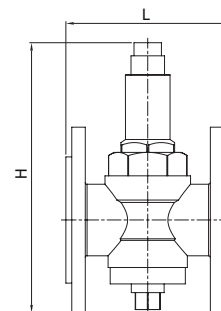

Ref. **3910I**

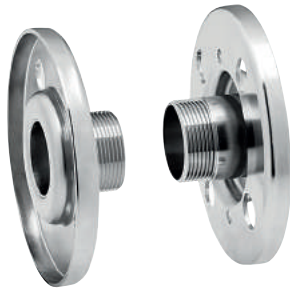

Brida roscada PN16

Construcción en acero inox. AISI 304. Extremo rosca macho (ISO 228/1). Aplicación para filtros autolimpiantes y reductoras de presión

Threaded flange PN 16

Stainless steel AISI 304 construction. Thread male end (ISO 228/1). Use mainly for self-cleaning filters and pressure reducing valves

R	A	C	H	D	S	N.º agujeros/ Num. holes
1 1/2"	150	110	46,5	16	3	4
2"	165	125	52,5	16	4	4
2 1/2"	185	145	62,5	18	4	4
3"	200	160	72,5	18	4	8
4"	225	180	83,5	19	5	8

CÓDIGO CODE	MEDIDA SIZE	PESO WEIGHT	CAJA / BOX CARTON	P.V.P. € PRICE €
----------------	----------------	----------------	----------------------	---------------------

3910I 08	1 1/2"	0,465	1	-
3910I 09	2"	0,750	1	-
3910I 10	2 1/2"	0,870	1	-
3910I 11	3"	0,990	1	-
3910I 12	4"	1,315	1	-

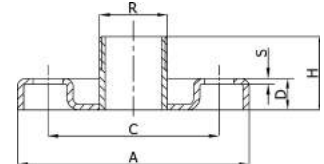

Ref. **3772 - 3773**



Racor 5 vías acoplamiento bombas

PN 16. Construcción latón UNE-EN 12165. Extremos roscados ISO 7/1 (EN 10226-1). Temperatura máxima trabajo 180°C.

5 ways fitting for pump connection

PN 16. Brass construction UNE-EN 12165. Threaded ends ISO 7/1 (EN 10226-1). Max. working temperature 180°C.

Ref.	A	B	C	D
3772	48	33	29	24
3773	67	33	29	24

3772 06 06	1" - 81 mm	0,266	12-144	-
3773 06 06	1" - 100 mm	0,293	8-96	-

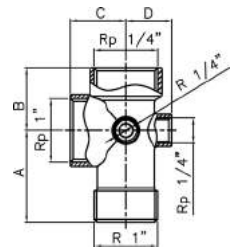

Ref. **3775**



Racor 5 vías de acoplamiento bombas inox. Longitud 99 mm

PN 10. Construcción en AISI 316 microfundición. Extremos rosca gas (BSP) M-H - ISO 228/1. Temp. máx. 180°C.

5 ways stainless steel fitting for pumps. Length 99 mm

PN 10. Material: AISI 316. Investment casting. Gas threaded ends (BSP) M-F - ISO 228/1. Max. temp. 180°C.

3775 06 06	1"	0,280	8-96	-
------------	----	-------	------	---

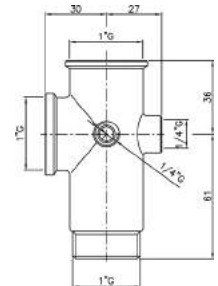

Ref. **3776**



Colector de bombeo

Construcción en acero inox AISI 304. Rosca gas (BSP) M-UNI, ISO 228/1.

Pumping collector

Stainless steel collector inox, AISI 304 threads UNI- ISO 228/1

R	r	r1	A	B	C	D	E	F
G1 1/2"	G1"	Female G1"	600	150	90	115	Male G 1/4"	Female G 1/4"

3776 08 06	1 1/2"	1,370	1-1	-
------------	--------	-------	-----	---

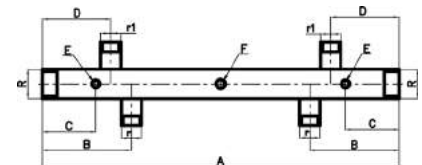

Ref. **3777**



Colector de aspiración

Construcción en acero inox AISI 304. Rosca gas (BSP) M, ISO 228/1

Suction collector

Stainless steel AISI 304. Gas threads ends (BSP) M, ISO 228/1

R	r	A	B	C
G2"	G 1 1/4"	600	300	65

3777 09 07	2" x 1 1/4"	1,500	1-1	-
------------	-------------	-------	-----	---

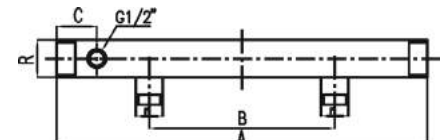

Ref. 3778



Colector para bomba

Construcción en acero inox AISI 304. Rosca gas (BSP) M, ISO 228/1

Pump manifold

Stainless steel AISI 304. Gas threads ends (BSP) M, ISO 228/1

R	r	A	B	G
G1 1/2"	G1 1/4"	200	100	45
G2"	G1 1/4"	200	100	45
G2"	G1 1/2"	200	100	45

CÓDIGO CODE	MEDIDA SIZE	PESO WEIGHT	CAJA / BOX CARTON	P.V.P. € PRICE €
3778 08 07	1 1/2" x 1 1/4"	0,001	1	-
3778 09 07	2" x 1 1/4"	0,001	1	-
3778 09 08	2" x 1 1/2"	0,001	1	-

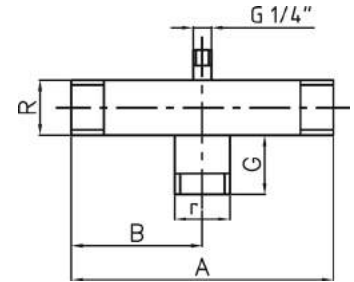

Ref. 3788



Colector para dos bombas

Construcción en acero inox AISI 304. Rosca gas (BSP) M, ISO 228/1

Two pumps manifold

Stainless steel AISI 304. Gas threads ends (BSP) M, ISO 228/1

R	r	A	B	C	G
G1 1/2"	G1"	600	120	270	45
G2"	G1 1/4"	600	120	270	45
G2"	G1 1/2"	600	120	270	45

3788 08 06	1 1/2" x 1"	0,001	1	-
3788 09 07	2" x 1 1/4"	0,001	1	-
3788 09 08	2" x 1 1/2"	0,001	1	-

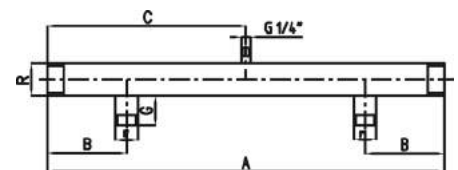

Ref. 3789

NEW



Extensor para bomba sumergida

Extensor roscado con gancho para bombas sumergibles. Construcción en acero inoxidable AISI 304. Extremos rosca gas (BSP) M, UNE-EN 228/1.

Extension for submersible pumps

Extension screws with hook for submersible pumps. Stainless steel AISI 304 construction. Gas threaded ends (BSP) M, UNE-EN 228/1.

R	A	B	C	D
1" x 1"	120	25	3	21
1 1/4" x 1 1/4"	150	25	3	21
1 1/2" x 1 1/2"	150	25	3	21
2" x 2"	200	25	3	21

3789 06	1" x 1"	-	-	-
3789 07	1 1/4" x 1 1/4"	-	-	-
3789 08	1 1/2" x 1 1/2"	-	-	-
3789 09	2" x 2"	-	-	-

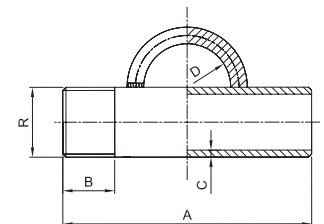

Ref. 3780



Presostato para agua

Para controlar presión de bombas de agua. Tensión de conexión 230V 50-60 Hz. Potencia máxima conexión 1,5 KW. Presión máxima trabajo 4 bar. Regulación de 0 a 4 bar. Tiempo máximo de maniobras 60 ciclos/min. Diferencial variable.

Pressure switch for water

To control pressure of water pumps. Connection voltage 230V 50-60 Hz. Max. connection power 1.5 KW. Max. working pressure 4 bar. Scale from 0 to 4 bar. Max. operating time 60 cycles/min. Variable differential.

3780 02	1/4"	0,356	1-64	-
---------	------	-------	------	---

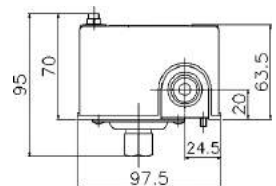

Ref. 3781



Presostato para agua

Para controlar presión de bombas de agua. Tensión de conexión 230V 50-60 Hz. Potencia máxima conexión 1,5 KW. Presión máxima trabajo 10 bar. Regulación de 4 a 10 bar. Tiempo máximo de maniobras 60 ciclos/min. Diferencial variable.

Pressure switch for water

To control pressure of water pumps. Connection voltage 230V- 50-60 Hz. Max. connection power 1.5 KW. Max. working pressure 10 bar. Scale from 4 to 10 bar. Max. operating time 60 cycles/min. Variable differential.

3781 02	1/4"	0,318	1-64	-
---------	------	-------	------	---

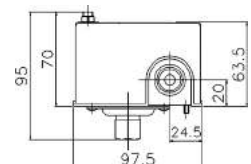

Ref. 3784



Presostato 1 vía para aire

Para controlar presión de compresores. Tensión de conexión 240V 50-60 Hz. Potencia máxima conexión 2,2 KW. Presión máxima trabajo 12 bar. Regulación de 1,5 a 12 bar. Diferencial variable. Rosca 1/4" NPT. Válvula de descarga incorporada. Función desconexión manual.

1 way pressure switch for air

To control pressure of air pumps. Connection voltage 240V 50-60 Hz. Max. connection power 2.2 KW. Max. working pressure 12 bar. Scale from 1.5 to 12 bar. Variable differential. NPT 1/4" thread. Discharge valve incorporated. Manual disconnection function.

CÓDIGO CODE	MEDIDA SIZE	PESO WEIGHT	CAJA / BOX CARTON	P.V.P. € PRICE €
3784 02	1/4" NPT	0,370	1-60	-

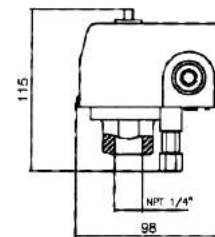

Ref. 3785



Presostato 4 vías para aire

Para controlar presión de compresores. Tensión de conexión 240V 50-60 Hz. Potencia máxima conexión 2,2 KW. Presión máxima trabajo 12 bar. Regulación de 1,5 a 12 bar. Diferencial variable. Rosca 1/4" NPT. Válvula de descarga incorporada. Función desconexión manual.

4 ways pressure switch for air

To control pressure of air pumps. Connection voltage 240V 50-60 Hz. Max. connection power 2.2 KW. Max. working pressure 12 bar. Scale from 1.5 to 12 bar. Variable differential. NPT 1/4" thread. Discharge valve incorporated. Manual disconnection function.

3785 02	1/4" NPT	0,350	1-60	-
---------	----------	-------	------	---

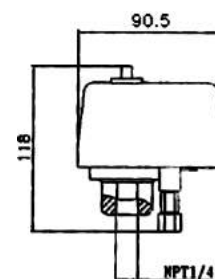

Ref. 3880



Interruptor de nivel vertical

Tensión de conexión 110-220V / 50-60 HZ. Potencia máxima de conexión 1,5KW. Temp. máx. ambiente 80°C.

Vertical level switch

Connection voltage 110-220V / 50-60 HZ. Max. connection power 1.5 KW. Max. ambient temp. 80°C.

3880 00	-	0,159	1-24	-
---------	---	-------	------	---

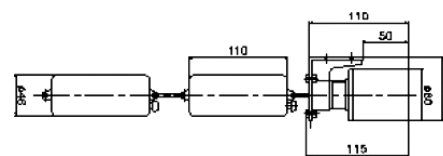

Ref. 3881



Interruptor de nivel horizontal para vaciado

Tensión de conexión 110-220V / 50-60 Hz. Potencia máxima de conexión 1,5Kw. Temp. máx. funcionamiento 50°C. Protección IP68. Código 3881 040 con longitud de cable 40cm. Código 3881 300 con longitud de cable 300cm.

Horizontal level switch for emptying

Supply voltage 110-220V / 50-60 Hz. Max. connection power 1.5 Kw. Max. operating temp 50°C. Protection IP68. Code 3881 040 with 40cm wire. Code 3881 300 with 300cm wire.

3881 040	-	0,210	1-24	-
3881 300	-	0,500	1-24	-

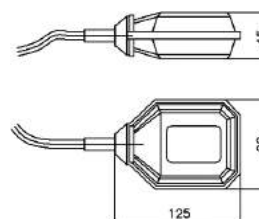

Ref. 3882



Contrapeso

Montable en el interruptor de nivel horizontal para la regulación de niveles. Temperatura máxima 50°C. Apto para cables hasta Ø 10 mm.

Counterweight

Assembling in the horizontal level switch - to regulate levels. Max. operating temp. 50°C suitable for cables until Ø 10 mm.

CÓDIGO CODE	MEDIDA SIZE	PESO WEIGHT	CAJA / BOX CARTON	P.V.P. € PRICE €
3882 00	-	0,236	1-100	-

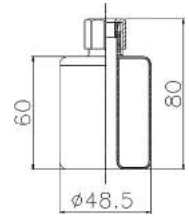

Ref. 3883



Interruptor de nivel horizontal conmutable

Tensión de conexión 110-220V / 50-60 Hz. Potencia máxima de conexión 1,5Kw. Temp. máx. funcionamiento 50°C. Protección IP68. Código 3883 300 con longitud de cable 300cm. Código 3883 500 con longitud de cable 500cm.

Commutable horizontal level switch

Supply voltage 110-220V / 50-60 Hz. Max. connection power 1.5 Kw. Max. operating temp 50°C. Protection IP68. Code 3883 300 with 300cm wire. Code 3883 500 with 500cm wire.

3883 300	-	0,720	1-22	-
3883 500	-	0,960	1-20	-

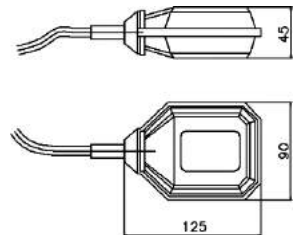

Ref. 3884



Controlador de volumen de aire

Construcción en acero al carbono zincado Q235 resistente al choque térmico. Membrana en polipropileno. Extremos roscados NPT 3/8" x 7/16" - 24. Para volúmenes de depósitos de 45 y 100 galones. Máx. temp. trabajo 60°C. Máx. presión trabajo 150 psi (10 bar).

Air volume control

Zinc plated carbon steel Q235A shock therm resistant construction. Polypropylene membrane. Threaded ends NPT 3/8" x 7/16" - 24. Available for tanks volume of 45 and 100 gallons. Max. working temp. 60°C. Max. working pressure: 150 psi (10 bar).

Ø D	H
104	92

3884 00	NPT 3/8" x 7/16" - 24	0,265	1-48	-
---------	-----------------------	-------	------	---

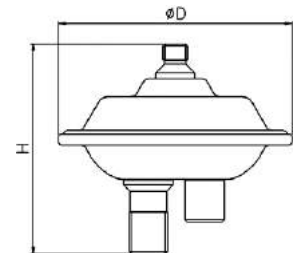

Ref. 3884



Controlador de volumen de aire

Construcción en aleación de zinc (Zamac). Membrana en EPDM. Conexiones roscadas hembra NPT 1/4" x NPT 3/8". Para volúmenes de depósitos de 120 galones. Máx. temp. trabajo 60°C. Máx. presión trabajo 150 psi.

Air volume control

Zinc alloy (Zamac) construction. EPDM membrane. Female threaded connections NPT 1/4" x NPT 3/8". Available for tanks volume of 120 gallons. Available for tanks volume of 120 gallons. Max. working temp. 60°C. Max. working pressure: 150 psi.

3884 120	NPT 1/4" x NPT 3/8"	860,000	1-20	-
----------	---------------------	---------	------	---

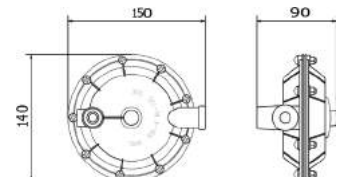

Ref. 3886



Válvula de flotador sin boya

Construcción en acero inoxidable AISI 304. Conexión rosca gas. Paso total. Cierre de silicona. Presión de trabajo máxima 10 BAR.

Floating valve without bouy

Made of stainless steel AISI 304. Conexion gas threaded. Full port. Silicone lock. Max. working pressure 10 BAR.

MED.	L	A
3/8"	300	32
1/2"	410	35
3/4"	500	42
1"	580	45
1 1/4"	580	52

3886 03	3/8"	0,151	1-20	-
3886 04	1/2"	0,255	1-20	-
3886 05	3/4"	0,400	1-15	-
3886 06	1"	0,520	1-10	-
3886 07	1 1/4"	0,620	1-10	-

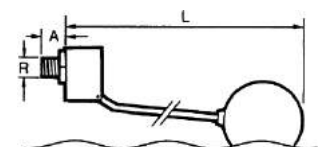

Ref. 3887



Boya para flotador
Construcción en acero inoxidable AISI 304.

Buoy for floating valves
Made of stainless steel AISI 304.

MED.	D	M
3/8"	90	M-6
1/2"	110	M-6
3/4"	160	M-8
1"	160	M-8
1 1/4"	160	M-8

CÓDIGO CODE	MEDIDA SIZE	PESO WEIGHT	CAJA / BOX CARTON	P.V.P. € PRICE €
-------------	-------------	-------------	-------------------	------------------

3887 090	Ø 90 mm	0,103	1-48	-
3887 110	Ø 110 mm	0,181	1-27	-
3887 160	Ø 160 mm	0,450	1-8	-

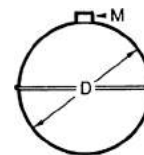

Ref. 2848



Controlador de flujo (líquidos)
Caja aleación aluminio. Racor latón. Lengüetas en acero inox. Para tuberías de 1" a 8". Conexión rosca 1" ISO 7/1 (EN 10226-1). Temp. máx. 110°C. Presión máx. 10 bar. 250V - 10A. Protección IP-64.

Liquid flow switch
Aluminium alloyed box. Brass connector. Blade: stainless steel for pipe from 1" to 8". Threaded connection 1" ISO 7/1 (EN 10226-1). Max. temp. 110°C. Max. pressure 10 bar. 250V - 10A. Protection IP-64.

2848 06	1"	800,000	1-10	-
---------	----	---------	------	---

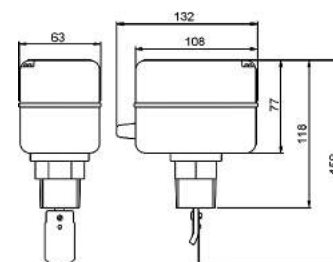

Ref. 2850



Controlador de flujo (líquidos)
Caja acero pintado - racor latón. Lengüetas en acero inox. Para tuberías de 1" a 8". Conexión rosca 1" ISO 7/1 (EN 10226-1). Temp. máx. 110°C. Presión máx. 10 bar. 250V - 10A. Protección IP-54.

Liquid flow switch
Coated steel box. Brass connector. Blade: stainless steel for pipe from 1" to 8". Threaded connection 1" ISO 7/1 (EN 10226-1). Max. temp. 110°C. Max. pressure 10 bar. 250V - 10A. Protection: IP 54.

2850 06	1"	800,000	1-10	-
---------	----	---------	------	---

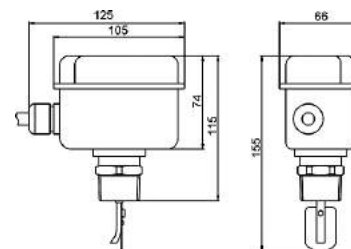

Ref. 3250



Controlador automático de bombas de agua
Para activar/desactivar el funcionamiento de una bomba en instalaciones y suministros. Tensión de conexión 220V-240V 50-60Hz. Intensidad máx. 30(16)A. Presión de arranque de bomba 1,5 bar. Máx. potencia 3 CV. Presión de trabajo 10 bar. Máx. temp. trabajo 60°C. Protección IP 65.

Automatic water pump control
To power on/off pump operation for installations and supply. Connection voltage 220V-240V 50-60Hz. Max. current 30(16)A. Start pressure 1,5 bar. Horse power 3 Hp. Max. working pressure 10 bar. Max. working temp. 60°C. IP 65.

3250 01	1 1/4" 1,5 BAR	0,001	1-8	-
3250 02	1 1/4" 2,2 BAR	0,001	1-8	-

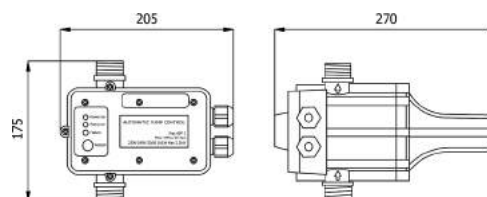

Ref. 3253



Controlador automático de bombas de agua

Para activar/desactivar el funcionamiento de una bomba en instalaciones y suministros. Tensión de conexión 110V-220V 50-60Hz. Intensidad máx. 10(6)A. Presión de arranque ajustable entre 1,5- 3 bar. Potencia 1,5 CV. Máx. presión de trabajo 10 bar. Máx. temp. trabajo 60°C. Protección IP 65. Manómetro 0-10 bar incorporado.

Automatic water pump control

To power on/off pump operation for installations and supply. Connection voltage 110V-220V 50-60Hz. Max. current 10(6)A. Start adjustable pressure 1.5- 3 bar. Horse power 1,5 Hp. Max. working pressure 10 bar. Max. working temp. 60°C. IP 65. Pressure gauge 0-10 bar incorporated.

CÓDIGO CODE	MEDIDA SIZE	PESO WEIGHT	CAJA / BOX CARTON	P.V.P. € PRICE €
3253	1" x 1"	1,063	1-16	-

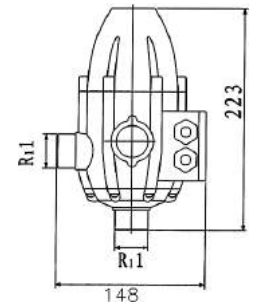

Ref. 3254



Controlador automático de bombas de agua

Para activar/desactivar el funcionamiento de una bomba en instalaciones y suministros. Tensión de conexión 220V-240V 50/60 Hz. Intensidad máx. 10(6)A. Presión de arranque/paro de bomba 1,5 bar. Potencia 1,5 CV. Máx. presión de trabajo 10 bar. Máx. temp. trabajo 60°C. Protección IP 65.

Automatic water pump control

To power on/off pump operation for installations and supply. Connection voltage 220V-240V 50/60 Hz. Max. current 10(6) A. Start/Stop pressure 1.5 bar. Horse power 1,5 Hp. Max. working pressure 10 bar. Max. working temp. 60°C. IP 65.

3254	1" x 1"	1,1	1-12	-
------	---------	-----	------	---

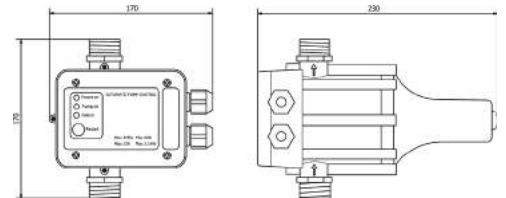

Ref. 3264



Controlador automático de bombas de agua

Para activar/desactivar el funcionamiento de una bomba en instalaciones y suministros. Tensión de conexión 110V-120V 50/60 Hz. Intensidad máx. 10(6)A. Presión de arranque/paro de bomba 1,5 bar. Potencia 1 CV. Máx. presión de trabajo 10 bar. Máx. temp. trabajo 60°C. Protección IP 65.

Automatic water pump control

To power on/off pump operation for installations and supply. Connection voltage 110V-120V 50/60 Hz. Max. current 10(6)A. Start/Stop pressure 1.5 bar. Horse power 1 Hp. Max. working pressure 10 bar. Max. working temp. 60°C. IP 65.

3264	1" x 1"	1,12	1-12	-
------	---------	------	------	---

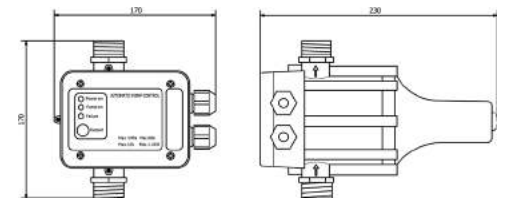

Ref. 3802

NEW

Manómetro Ø 40, salida posterior, rosca BSP
Caja ABS. Tubo bourdon y racor latón UNE-EN 12165. Rosca 1/8" macho gas (BSP). Graduaciones disponibles 0 a 2,5-4-6-10-16-25 bar. Salida posterior. Clase de precisión 2,5.

Pressure gauge Ø 40, back connection, BSP thread
ABS case. Brass bourdon pipe and connector UNE-EN 12165. 1/8" male gas threaded (BSP). Scale available from 0 to 2,5-4-6-10-16-25 bar. Back connection. Precision class 2,5.



A	L	D
39	40	25
39	40	25
39	40	25
39	40	25
39	40	25
39	40	25

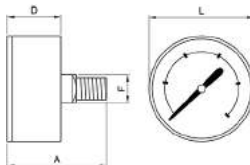

CÓDIGO CODE	BAR	PSI	PESO WEIGHT	CAJA / BOX CARTON	P.V.P. € PRICE €
3802 002	0-2,5	0-40	0,036	1-240	-
3802 004	0-4	0-60	0,036	1-240	-
3802 006	0-6	0-90	0,036	1-240	-
3802 010	0-10	0-150	0,036	1-240	-
3802 016	0-16	0-240	0,036	1-240	-
3802 025	0-25	0-400	0,036	1-240	-

Ref. 3819

Manómetro Ø 53 indicador rojo, salida inferior
Caja ABS. Tubo bourdon y racor latón UNE-EN 12165. Rosca 1/4" macho gas (BSP). Graduaciones disponibles 0 a 2,5-4-6-10-16-25 bar. Salida inferior (radial). Clase de precisión 2,5.

Pressure gauge Ø 53, red index, bottom connection
ABS case. Brass bourdon pipe and connector UNE-EN 12165. 1/4" male gas threaded (BSP). Scale available from 0-2,5-4-6-10-16-25 bar. Bottom connection (radial). Precision class 2,5.



A	L	D
46	53	27

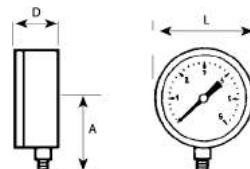

CÓDIGO CODE	BAR	PSI	PESO WEIGHT	CAJA / BOX CARTON	P.V.P. € PRICE €
3819 002	0-2,5	0-40	0,061	1-280	-
3819 004	0-4	0-60	0,061	1-280	-
3819 006	0-6	0-90	0,061	1-160	-
3819 010	0-10	0-150	0,061	1-160	-
3819 016	0-16	0-240	0,061	1-280	-
3819 025	0-25	0-400	0,061	1-280	-

Ref. 3818

Manómetro Ø 53 indicador rojo, salida posterior
Caja ABS. Tubo bourdon y racor latón UNE-EN 12165. Rosca 1/4" macho gas (BSP). Graduaciones disponibles 0 a 2,5-4-6-10-16-25 bar. Salida posterior. Clase de precisión 2,5.

Pressure gauge Ø 53, red index, back connection
ABS case. Brass bourdon pipe and connector UNE-EN 12165. 1/4" male gas threaded (BSP). Scale available from 0-2,5-4-6-10-16-25 bar. Back connection. Precision class 2,5.



A	L	D
48	53	27

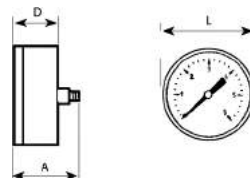

CÓDIGO CODE	BAR	PSI	PESO WEIGHT	CAJA / BOX CARTON	P.V.P. € PRICE €
3818 002	0-2,5	0-40	0,068	1-210	-
3818 004	0-4	0-60	0,068	1-210	-
3818 006	0-6	0-90	0,068	1-210	-
3818 010	0-10	0-150	0,068	1-210	-
3818 016	0-16	0-240	0,068	1-210	-
3818 025	0-25	0-400	0,068	1-210	-

Ref. 3820

Manómetro Ø 53, salida inferior, rosca BSP
Caja ABS. Tubo bourdon y racor latón UNE-EN 12165. Rosca 1/4" macho gas (BSP). Graduaciones disponibles 0 a 2,5-4-6-10-16-25 bar. Salida inferior (radial). Clase de precisión 2,5.

Pressure gauge Ø 53, bottom connection, BSP thread
ABS case. Brass bourdon pipe and connector UNE-EN 12165. 1/4" male gas threaded (BSP). Scale available from 0-2,5-4-6-10-16-25 bar. Bottom connection (radial). Precision class 2,5.



A	L	D
47	53	27

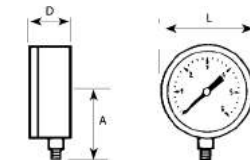

CÓDIGO CODE	BAR	PSI	PESO WEIGHT	CAJA / BOX CARTON	P.V.P. € PRICE €
3820 002	0-2,5	0-40	0,064	1-280	-
3820 004	0-4	0-60	0,064	1-280	-
3820 006	0-6	0-90	0,064	1-280	-
3820 010	0-10	0-150	0,064	1-280	-
3820 016	0-16	0-240	0,064	1-280	-
3820 025	0-25	0-400	0,064	1-280	-

Ref. 3820N



Manómetro Ø 53, salida inferior, rosca NPT
Caja ABS. Tubo bourdon y racor latón UNE-EN 12165. Rosca 1/4" macho (NPT). Graduaciones disponibles 0 a 2,5-4-6-10-16-25 bar. Salida inferior (radial). Clase de precisión 2,5.

Pressure gauge Ø 53, bottom connection, NPT thread
ABS case. Brass bourdon pipe and connector UNE-EN 12165. 1/4" male threaded (NPT). Scale available from 0-2,5-4-6-10-16-25 bar. Bottom connection (radial). Precision class 2.5.

Several scales available

A	L	D
47	53	27

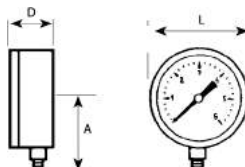

CÓDIGO CODE	BAR	PSI	PESO WEIGHT	CAJA / BOX CARTON	P.V.P. € PRICE €
3820N 002	0-2,5	0-40	0,064	1-160	-
3820N 004	0-4	0-60	0,064	1-160	-
3820N 006	0-6	0-90	0,064	1-280	-
3820N 010	0-10	0-150	0,064	1-280	-
3820N 016	0-16	0-240	0,064	1-160	-
3820N 025	0-25	0-400	0,064	1-280	-

Ref. 3821



Manómetro Ø 53, salida posterior, rosca BSP
Caja ABS. Tubo bourdon y racor latón UNE-EN 12165. Rosca 1/4" macho gas (BSP). Graduaciones disponibles 0 a 2,5-4-6-10-16-25 bar. Salida posterior. Clase de precisión 2,5.

Pressure gauge Ø 53, back connection, BSP thread
ABS case. Brass bourdon pipe and connector UNE-EN 12165. 1/4" male gas threaded (BSP). Scale available from 0-2,5-4-6-10-16-25 bar. Back connection. Precision class 2.5.

A	L	D
48	53	27

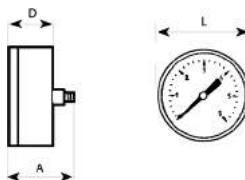

3821 002	0-2,5	0-40	0,067	1-210	-
3821 004	0-4	0-60	0,067	1-210	-
3821 006	0-6	0-90	0,067	1-210	-
3821 010	0-10	0-150	0,067	1-210	-
3821 016	0-16	0-240	0,067	1-210	-
3821 025	0-25	0-400	0,067	1-210	-

Ref. 3825



Manómetro Ø 63, indicador rojo, salida inferior
Caja ABS. Tubo bourdon y racor latón UNE-EN 12165. Rosca 1/4" macho gas (BSP). Graduaciones disponibles 0 a 2,5-4-6-10-16-25 bar. Salida inferior (radial). Clase de precisión 2,5.

Pressure gauge Ø 63, red index, bottom connection
ABS case. Brass bourdon pipe and connector UNE-EN 12165. 1/4" male gas threaded (BSP). Scale available from 0-2,5-4-6-10-16-25 bar. Bottom connection (radial). Precision class 2.5.

A	L	D
50	63	28

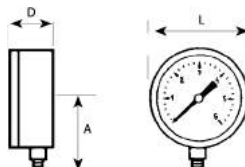

3825 002	0-2,5	0-40	0,075	1-180	-
3825 004	0-4	0-60	0,075	1-180	-
3825 006	0-6	0-90	0,075	1-180	-
3825 010	0-10	0-150	0,075	1-180	-
3825 016	0-16	0-240	0,075	1-180	-
3825 025	0-25	0-400	0,075	1-180	-

Ref. 3826



Manómetro Ø 63, indicador rojo, salida posterior
Caja ABS. Tubo bourdon y racor latón UNE-EN 12165. Rosca 1/4" macho gas (BSP). Graduaciones disponibles 0 a 2,5-4-6-10-16-25 bar. Salida posterior. Clase de precisión 2,5.

Pressure gauge Ø 63, red index, back connection
ABS case. Brass bourdon pipe and connector UNE-EN 12165. 1/4" male gas threaded (BSP). Scale available from 0-2,5-4-6-10-16-25 bar. Back connection (radial). Precision class 2.5.

A	L	D
49	63	29

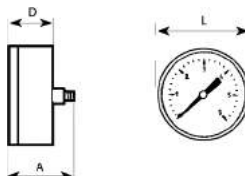

3826 002	0-2,5	0-40	0,078	1-175	-
3826 004	0-4	0-60	0,078	1-132	-
3826 006	0-6	0-90	0,078	1-132	-
3826 010	0-10	0-150	0,078	1-132	-
3826 016	0-16	0-240	0,078	1-175	-
3826 025	0-25	0-400	0,078	1-132	-

Ref. 3822



Manómetro Ø 63 con glicerina, salida inferior, rosca BSP
Caja acero inox. AISI 304. Tubo bourdon y racor latón UNE-EN 12165. Rosca 1/4" macho gas (BSP). Graduaciones disponibles 0 a 2,5-4-6-10-16-25-60-100 bar. Salida inferior (radial). Clase de precisión 2,5.

Pressure gauge Ø 63 with glycerine, bottom connection, BSP thread
Stainless steel AISI 304 case. Brass bourdon pipe and connector UNE-EN 12165. 1/4" male gas threaded (BSP). Scale available from 0-2,5-4-6-10-16-25-60-100 bar. Bottom connection (radial). Precision class 2.5.

A	L	D
55	63	30

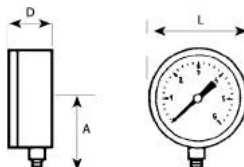

CÓDIGO CODE	BAR	PSI	PESO WEIGHT	CAJA / BOX CARTON	P.V.P. € PRICE €
3822 002	0-2,5	0-40	0,180	1-160	-
3822 004	0-4	0-60	0,180	1-160	-
3822 006	0-6	0-90	0,180	1-160	-
3822 010	0-10	0-150	0,180	1-160	-
3822 016	0-16	0-240	0,180	1-160	-
3822 025	0-25	0-400	0,180	1-160	-
3822 060	0-60	0-900	0,180	1-160	-
3822 100	0-100	0-1500	0,180	1-160	-

Ref. 3822N



Manómetro Ø 63 con glicerina, salida inferior, rosca NPT
Caja acero inox. AISI 304. Tubo bourdon y racor latón UNE-EN 12165. Rosca 1/4" macho (NPT). Graduaciones disponibles 0 a 2,5-4-6-10-16-25-60-100 bar. Salida inferior (radial). Clase de precisión 2,5.

Pressure gauge Ø 63 with glycerine, bottom connection, NPT thread
Stainless steel AISI 304 case. Brass bourdon pipe and connector UNE-EN 12165. 1/4" male threaded (NPT). Scale available from 0-2,5-4-6-10-16-25-60-100 bar. Bottom connection (radial). Precision class 2.5.

Several scales available

A	L	D
55	63	30

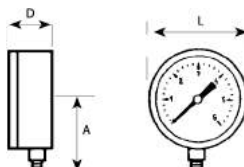

3822N 002	0-2,5	0-40	0,180	1-160	-
3822N 004	0-4	0-60	0,180	1-160	-
3822N 006	0-6	0-90	0,180	1-160	-
3822N 010	0-10	0-150	0,180	1-160	-
3822N 016	0-16	0-240	0,180	1-160	-
3822N 025	0-25	0-400	0,180	1-160	-
3822N 060	0-60	0-900	0,180	1-160	-
3822N 100	0-100	0-1500	0,180	1-160	-

Ref. 3829



Manómetro Ø 63 con glicerina, salida posterior, rosca BSP
Caja acero inox. AISI 304. Tubo bourdon y racor latón UNE-EN 12165. Rosca 1/4" macho gas (BSP). Graduaciones disponibles 0 a 2,5-4-6-10-16-25-60-100 bar. Salida posterior. Clase de precisión 2,5.

Pressure gauge Ø 63 with glycerine, back connection, BSP thread
Stainless steel AISI 304 case. Brass bourdon pipe and connector UNE-EN 12165. 1/4" male gas threaded (BSP). Scale available from 0-2,5-4-6-10-16-25-60-100 bar. Back connection. Precision class 2.5.

A	L	D
48	63	27

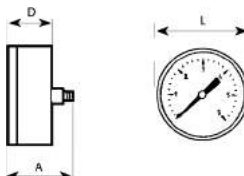

3829 002	0-2,5	0-40	0,180	1-60	-
3829 004	0-4	0-60	0,180	1-60	-
3829 006	0-6	0-90	0,180	1-60	-
3829 010	0-10	0-150	0,180	1-60	-
3829 016	0-16	0-240	0,180	1-60	-
3829 025	0-25	0-400	0,180	1-60	-
3829 060	0-60	0-900	0,180	1-60	-
3829 100	0-100	0-1500	0,180	1-60	-

Ref. 3814



Manómetro Ø 63 con glicerina, salida inferior, rosca BSP
Caja acero inox AISI 304. Tubo bourdon y racor en acero inox. AISI 304. Rosca 1/4" macho gas (BSP). Graduaciones disponibles 0 a 2,5-4-6-10-16-25-40- 60-100 bar. Salida inferior (radial). Clase de precisión 2,5.

Pressure gauge Ø 63 with glycerine, bottom connection, BSP thread
Stainless steel AISI 304 case - bourdon pipe and connector. 1/4" male gas threaded (BSP). Scale available from 0-2,5-4 -6-10-16-25-40-60-100 bar. Bottom connection (radial). Precision class 2.5.

A	L	D
56	63	30

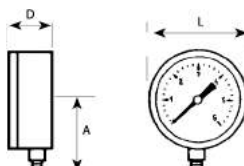

3814 002	0-2,5	0-40	0,210	1-160	-
3814 004	0-4	0-60	0,210	1-160	-
3814 006	0-6	0-90	0,210	1-160	-
3814 010	0-10	0-150	0,210	1-160	-
3814 016	0-16	0-240	0,210	1-160	-
3814 025	0-25	0-400	0,210	1-160	-
3814 040	0-40	0-600	0,210	1-160	-
3814 060	0-60	0-900	0,210	1-160	-
3814 100	0-100	0-1500	0,210	1-160	-

Ref. 3714



Manómetro Ø 63 mm, salida inferior, rosca NPT
Caja acero al carbono. Tubo bourdon y racor latón UNE-EN 12165. Rosca macho 1/4" NPT. Salida inferior (radial). Clase de precisión 2,5. Escala de medición Kgf/cm², psi.

Pressure gauge Ø 63 mm, bottom connection, NPT thread
Carbon steel case. Brass bourdon pipe and connector UNE-EN 12165. 1/4" male NPT threaded. Bottom connection (radial). Precision class 2.5. Kgf/cm², psi scale.

A	L	D
51	63	30

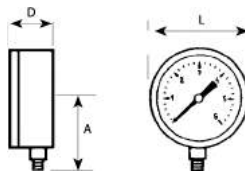

CÓDIGO CODE	BAR	PSI	PESO WEIGHT	CAJA / BOX CARTON	P.V.P. € PRICE €
3714 004	0-4	0-60	0,100	1-160	-
3714 007	0-7	0-100	0,100	1-200	-
3714 010	0-10	0-150	0,100	1-200	-
3714 014	0-14	0-200	0,100	1-160	-
3714 017	0-17	0-250	0,100	1-160	-
3714 021	0-21	0-300	0,100	1-160	-
3714 028	0-28	0-400	0,100	1-160	-

Ref. 3827



Manómetro Ø 80 mm, indicador rojo, salida inferior, rosca BSP
Caja ABS, índice rojo, doble escala. Tubo Bourdon y racor en latón UNE-EN 12165. Rosca 3/8" macho gas (BSP). Graduaciones disponibles 0 a 2,5-4-6-10-16-25-40 bar. Salida inferior. Clase de precisión 2,5.

Pressure gauge Ø 80 mm, red index, bottom connection, BSP thread
ABS Case, red index, double scale. Bourdon pipe and connector 3/8" male gas threaded (BSP). Scale available from 0-2.5-4-6-10-16-25-40 bar. Bottom connection (radial). Precision class 2.5.

A	L	D
70	80	32

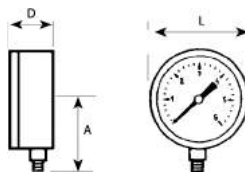

3827 002	0-2,5	0-40	0,130	1-100	-
3827 004	0-4	0-60	0,130	1-100	-
3827 006	0-6	0-90	0,130	1-100	-
3827 010	0-10	0-150	0,130	1-100	-
3827 016	0-16	0-240	0,130	1-100	-
3827 025	0-25	0-400	0,130	1-100	-
3827 040	0-40	0-600	0,130	1-100	-

Ref. 3824



Manómetro Ø 100 con glicerina, salida inferior, rosca BSP
Caja acero inox AISI 304, tubo bourdon y racor en acero inox. AISI 304. Rosca 1/2" macho gas (BSP). Graduaciones disponibles 0 a 2,5-4-6-10-16-25-40-60-100 bar. Salida inferior (radial). Clase de precisión 1,6.

Pressure gauge Ø 100 with glycerine, bottom connection, BSP thread
Stainless steel AISI 304 case, bourdon pipe and connector. 1/2" male gas threaded (BSP). Scale available from 0-2,5-4-6-10-16-25-40-60-100 bar. Bottom connection (radial). Precision class 1.6.

A	L	D
85	100	36

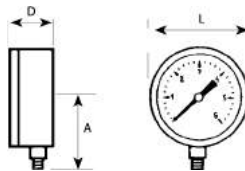

3824 002	0-2,5	0-40	0,550	1-44	-
3824 004	0-4	0-60	0,550	1-44	-
3824 006	0-6	0-90	0,550	1-44	-
3824 010	0-10	0-150	0,550	1-44	-
3824 016	0-16	0-240	0,550	1-44	-
3824 025	0-25	0-400	0,550	1-44	-
3824 040	0-40	0-600	0,550	1-44	-
3824 060	0-60	0-900	0,550	1-44	-
3824 100	0-100	0-1500	0,550	1-44	-

Ref. 3824N



Manómetro Ø 100 con glicerina, salida inferior, rosca NPT
Caja acero inox AISI 304, tubo Bourdon y racor en acero inox. AISI 304. Rosca 1/2" macho (NPT). Graduaciones disponibles 0 a 4-6-10-16-25-40 bar. Salida inferior (radial). Clase de precisión 1,6.

Pressure gauge Ø 100 with glycerine, bottom connection, NPT thread
Stainless steel AISI 304 case, Bourdon pipe and connector. 1/2" male threaded (NPT). Scale available from 0-4-6-10-16-25-40-60-100 bar. Bottom connection (radial). Precision class 1.6.

A	L	D
85	100	36

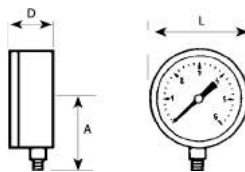

3824N 004	0-4	0-60	0,550	1-44	-
3824N 006	0-6	0-90	0,550	1-30	-
3824N 010	0-10	0-150	0,550	1-44	-
3824N 016	0-16	0-240	0,550	1-44	-
3824N 025	0-25	0-400	0,550	1-44	-
3824N 040	0-40	0-600	0,550	1-44	-

Ref. **3950 - 3952 - 3955**



3950 - Cinta "PTFE"
12 m de longitud 0,075 mm de espesor, 12 mm de ancho 0,35 g/cm³ de densidad.

3950 - "PTFE" tape
12 m length 0.075 mm thickness, 12 mm width 0.35 g/cm³ density.

3952 - Cinta "PTFE"
12 m de longitud 0,060 mm de espesor 12 mm de ancho 0,26 g/cm³ de densidad.

3952 - "PTFE" tape
12 m length 0.060 mm thickness, 12 mm width 0.26 g/cm³ density.

3955 - Cinta "PTFE"
50 m de longitud 0,1 mm de espesor, 19 mm de ancho 0,54 g/cm³ de densidad.

3955 - "PTFE" tape
50 m length 0.1 mm thickness, 19 mm width 0.54 g/cm³ density.

CÓDIGO CODE	MEDIDA SIZE	PESO WEIGHT	CAJA / BOX CARTON	P.V.P. € PRICE €
-------------	-------------	-------------	-------------------	------------------

3950 00	0,075 x 12	0,004	100-1000	-
---------	------------	-------	----------	---

3952 00	0,060 x 12	0,007	100-1000	-
---------	------------	-------	----------	---

3955 00	0,1 x 19	0,080	25-200	-
---------	----------	-------	--------	---

Ref. **3956**



PTFE líquido 50 ml
Adhesivo anaeróbico para sellar conexiones roscadas metálicas. Resistente a golpes y vibraciones. Temperaturas desde -55°C a +150°C. Fácil desmontaje de piezas selladas.

Liquid "PTFE" 50 ml
Anaerobic adhesive for sealing metal thread pipe joints. Shocks and vibrations resistant. Temperatures from -55°C to +150°C. Easy dismantling of sealed joints.

3956 00	50 ml	0,020	10-50	-
---------	-------	-------	-------	---

Ref. 3760

NEW



Conjunto flexible de acero inoxidable AISI 316L

Tubo flexible de acero inoxidable AISI 316L. Conexión macho fijo de acero inoxidable AISI 304 - tuerca hembra giratoria de latón niquelado, roscas según ISO 7/1 (UNE-EN 10266). Presión máxima de trabajo 10 bar. Temperatura de trabajo -20°C a 100°C.

AISI 316L Stainless steel flexible hose

Stainless steel flexible hose AISI 316L. Connection AISI 304 stainless steel male - nickel plated swivel female acc/ ISO 7/1 (UNE-EN 10266). Maximum working pressure 10 bar. Working temperature -20°C to 100°C

DN	R	R1	L (mm)
DN15	R1/2"	Rp1/2"	300
DN15	R1/2"	Rp1/2"	400
DN15	R1/2"	Rp1/2"	500

CÓDIGO CODE	MEDIDA SIZE	PESO WEIGHT	CAJA / BOX CARTON	P.V.P. € PRICE €
-------------	-------------	-------------	-------------------	------------------

3760 04 30	1/2"	0,112	-	-
3760 04 40	1/2"	0,120	-	-
3760 04 50	1/2"	0,134	-	-

Ref. 3762

NEW



Conjunto flexible extensible de acero inoxidable AISI 316L

Tubo flexible de acero inoxidable AISI 316L. Conexión macho fijo de acero inoxidable AISI 304 - tuerca hembra giratoria de latón niquelado, roscas según ISO 7/1 (UNE-EN 10266). Presión máxima de trabajo 10 bar. Temperatura de trabajo -20°C a 100°C.

AISI 316L Stainless steel flexible extendable hose

Stainless steel flexible hose AISI 316L. Connection AISI 304 stainless steel male - nickel plated swivel female acc/ ISO 7/1 (UNE-EN 10266). Maximum working pressure 10 bar. Working temperature -20°C to 100°C

DN	R	R1	L1 (mm)	L2 (mm)
DN15	R1/2"	Rp1/2"	200	420
DN15	R1/2"	Rp1/2"	400	900

3762 04 20	1/2"	0,106	-	-
3762 04 40	1/2"	0,154	-	-

Ref. 3770

NEW



Conjunto flexible extensible de acero inoxidable AISI 304

Tubo flexible de acero inoxidable AISI 304. Conexión macho fijo de acero inoxidable AISI 304 - tuerca hembra giratoria de latón niquelado, roscas según ISO 7/1 (UNE-EN 10266). Presión máxima de trabajo 10 bar. Temperatura de trabajo -20°C a 100°C.

AISI 304 Stainless steel flexible extendable hose

Stainless steel flexible hose AISI 304. Connection AISI 304 stainless steel male - nickel plated swivel female acc/ ISO 7/1 (UNE-EN 10266). Maximum working pressure 10 bar. Working temperature -20°C to 100°C

DN	R	R1	L1 (mm)	L2 (mm)
DN15	R1/2"	Rp1/2"	200	420
DN15	R1/2"	Rp1/2"	400	1050
DN15	R1/2"	Rp1/2"	750	2000
DN20	R3/4"	Rp3/4"	200	420
DN20	R3/4"	Rp3/4"	400	1050
DN20	R3/4"	Rp3/4"	750	2000
DN25	R1"	Rp1"	200	420
DN25	R1"	Rp1"	400	1050
DN25	R1"	Rp1"	750	2000

3770 04 20	1/2"	-	-	-
3770 04 40	1/2"	0,15	-	-
3770 04 75	1/2"	-	-	-
3770 05 20	3/4"	-	-	-
3770 05 40	3/4"	-	-	-
3770 05 75	3/4"	-	-	-
3770 06 20	1"	-	-	-
3770 06 40	1"	-	-	-
3770 06 75	1"	-	-	-

VÁLVULAS VALVES

SERVICIOS DE AGUA

El sistema GE-Block patentado por Genebre, diseñado para nuestra gama de válvulas antifraude, permite mediante una llave especial, bloquear la válvula en posición de apertura, cierre y 10% del caudal nominal.

Dirigido a empresas proveedoras de las compañías de distribución de agua de cada país.

CARACTERÍSTICAS DE LAS VÁLVULAS

- Construcción en latón UNE-EN 12164-12165
- Extremos roscados ISO 228/1
- Extremos conexión tubería PE baja, media y alta densidad
- Tapón de protección precintable
- Temperatura de trabajo de -20°C a 110°C
- Presión máxima de trabajo 25 bar.

WATERWORKS

GE-Block system patented by Genebre, designed for our anti-fraud valves let by means and special key, block the valve in open, close and 10% open positions.

This valve system is intended for valve and pipe suppliers for water supply companies from every country.

VALVES CHARACTERISTICS

- Brass construction UNE-EN 12164-12165
- Threaded ends ISO 228/1
- Connection ends for low, medium and high density PE pipe
- Sealable protection cap.
- Working temperature from -20°C to 110°C
- Maximum working pressure 25 bar.



Procedimiento de funcionamiento
Working process

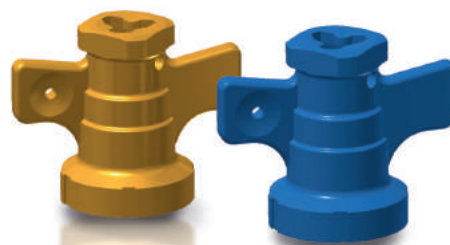
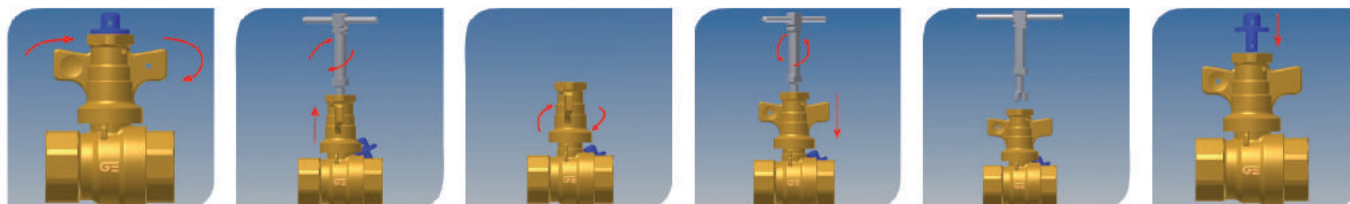

Accionamiento antifraude latón / aluminio
Brass / aluminium anti-fraud handle



Accionamiento latón / aluminio
Brass / aluminium handle

Ref. 3430 - 3430N



Válvula antifraude recta H-H

También disponible con rosca NPT (3430N).
PN 25. Paso estándar. Construcción en latón UNE-EN 12165. Asientos PTFE. Extremos rosca gas (BSP) H-H - ISO 228/1. Temp. máx. 110°C. Mando manual mediante llave antifraude.

Against fraud straight valve F-F

Also available NPT thread (3430N)
PN 25. Standard bore. Brass construction UNE-EN 12165. PTFE seats. Gas threaded ends (BSP) F-F - ISO 228/1. Max. Temp. 110°C. Manual control with anti-fraud key.

R	ØP	L	A	M
G 1/2"	13,5	48	63	48,5
G 3/4"	18	55	65,5	48,5
NPT 1/2"	13,5	48	63	48,5
NPT 3/4"	18	55	65,5	48,5

CÓDIGO CODE	MEDIDA SIZE	PESO WEIGHT	CAJA / BOX CARTON	P.V.P. € PRICE €
3430 04	1/2"	0,195	5-120	-
3430 05	3/4"	0,260	5-90	-
3430N 04	1/2"	0,195	5-120	-
3430N 05	3/4"	0,260	5-90	-

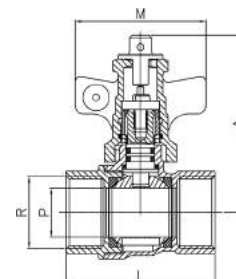

Ref. 3434

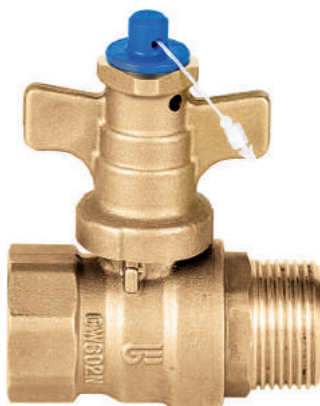

Válvula antifraude recta M-H

PN 25. Paso estándar. Construcción en latón UNE-EN 12165. Asientos PTFE. Extremos rosca gas (BSP) M-H - ISO 228/1. Temp. máx. 110°C. Mando manual mediante llave antifraude.

Against fraud straight valve M-F

PN 25. Standard bore. Brass construction UNE-EN 12165. PTFE seats. Gas threaded ends (BSP) M-F - ISO 228/1. Max. Temp. 110°C. Manual control with anti-fraud key.

R	ØP	L	A	M
G 1/2"	13,5	54,5	63	48,5
G 3/4"	18	62,5	65,5	48,5

CÓDIGO CODE	MEDIDA SIZE	PESO WEIGHT	CAJA / BOX CARTON	P.V.P. € PRICE €
3434 04	1/2"	0,205	5-120	-
3434 05	3/4"	0,275	5-90	-

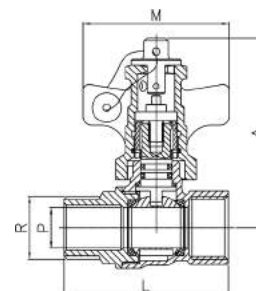

Ref. 3438



Válvula antifraude recta H-tuerca loca

PN 25. Paso estándar. Construcción en latón UNE-EN 12165. Asientos PTFE. Extremos rosca gas (BSP) H-tuerca loca - ISO 228/1. Temp. máx. 110°C. Mando manual mediante llave antifraude.

Against fraud straight valve F-free nut

PN 25. Standard bore. Brass construction UNE-EN 12165. PTFE seats. Gas threaded ends (BSP) F-free nut - ISO 228/1. Max. Temp. 110°C. Manual control with anti-fraud key.

r	R	ØP	L	A	M
G 1/2"	G 3/4"	13,5	59,5	63	48,5
G 3/4"	G 3/4"	18	65	65,5	48,5

CÓDIGO CODE	MEDIDA SIZE	PESO WEIGHT	CAJA / BOX CARTON	P.V.P. € PRICE €
3438 04 05	1/2" x 3/4"	0,255	10-120	-
3438 05 05	3/4" x 3/4"	0,320	8-96	-

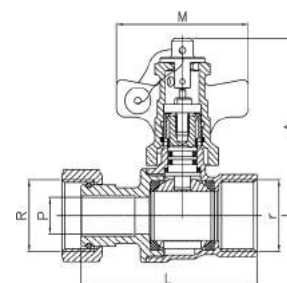

Ref. 3442



Válvula antifraude recta tubo PE-tuerca loca

PN 25. Paso estándar. Construcción en latón UNE-EN 12165. Asientos PTFE. Extremos conexión tubo PE-tuerca loca rosca gas (BSP) - ISO 228/1. Temp. máx. 110°C. Mando manual mediante llave antifraude.

Against fraud straight valve PE-free nut

PN 25. Standard bore. Brass construction UNE-EN 12165. PTFE seats. End connection PE pipe-free nut gas threaded (BSP) - ISO 228/1. Max. temp. 110°C. Manual control with anti-fraud key.

R	ØD	ØP	L	A	M
G 3/4"	20	13,5	76	63	48,5

CÓDIGO CODE	MEDIDA SIZE	PESO WEIGHT	CAJA / BOX CARTON	P.V.P. € PRICE €
3442 20 05	PE20 x 3/4"	0,315	8-96	-

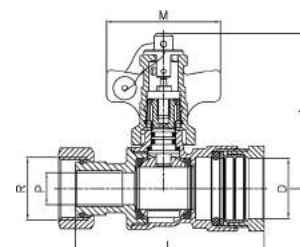

Ref. 3446



Válvula antifraude recta M-tuerca loca
 PN 25. Paso estándar. Construcción en latón UNE-EN 12165. Asientos PTFE. Extremos rosca gas (BSP) M-tuerca loca - ISO 228/1. Temp. máx. 110°C. Mando manual mediante llave antifraude.

Against fraud straight valve M-free nut
 PN 25. Standard bore. Brass construction UNE-EN 12165. PTFE seats. Gas threaded ends (BSP) M-free nut - ISO 228/1. Max. Temp. 110°C. Manual control with anti-fraud key.

r	R	ØP	L	A	M
G 1/2"	G 3/4"	13,5	62,5	63	48,5
G 3/4"	G 3/4"	18	68,5	65,5	48,5

CÓDIGO CODE	MEDIDA SIZE	PESO WEIGHT	CAJA / BOX CARTON	P.V.P. € PRICE €
3446 04 05	1/2" x 3/4"	0,255	10-120	-
3446 05 05	3/4" x 3/4"	0,320	8-96	-

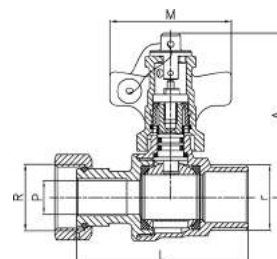

Ref. 3450

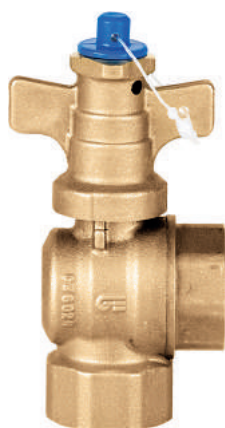

Válvula antifraude angular H-H
 PN 25. Paso estándar. Construcción en latón UNE-EN 12165. Asientos PTFE. Extremos rosca gas (BSP) H-H - ISO 228/1. Temp. máx. 110°C. Mando manual mediante llave antifraude.

Against fraud angle valve F-F
 PN 25. Standard bore. Brass construction UNE-EN 12165. PTFE seats. Gas threaded ends (BSP) F-F - ISO 228/1. Max. Temp. 110°C. Command with anti-fraud key.

R	ØP	L	A	M
G 1/2"	13	24	63	48,5
G 3/4"	17,5	27,5	65,5	48,5

3450 04	1/2"	0,200	10-80	-
3450 05	3/4"	0,270	8-64	-

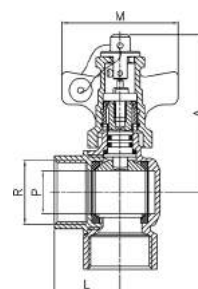

Ref. 3454



Válvula antifraude angular H-tuerca loca
 PN 25. Paso estándar. Construcción en latón UNE-EN 12165. Asientos PTFE. Extremos rosca gas (BSP) H-tuerca loca - ISO 228/1. Temp. máx. 110°C. Mando manual mediante llave antifraude.

Against fraud angle valve F-free nut
 PN 25. Standard bore. Brass construction UNE-EN 12165. PTFE seats. Gas threaded ends (BSP) F-free nut - ISO 228/1. Max. Temp. 110°C. Manual control with anti-fraud key.

r	R	ØP	L	A	M
G 1/2"	G 3/4"	13	35,5	63	48,5
G 3/4"	G 3/4"	17,5	37,5	65,5	48,5

3454 04 05	1/2" x 3/4"	0,260	8-96	-
3454 05 05	3/4" x 3/4"	0,330	8-96	-

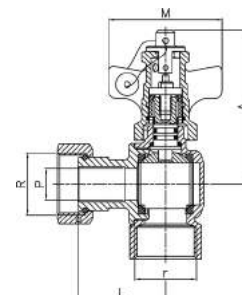

Ref. 3462



Válvula antifraude angular M-tuerca loca
 PN 25. Paso estándar. Construcción en latón UNE-EN 12165. Asientos PTFE. Extremos rosca gas (BSP) M-tuerca loca - ISO 228/1. Temp. máx. 110°C. Mando manual mediante llave antifraude.

Against fraud angle valve M-free nut
 PN 25. Standard bore. Brass construction UNE-EN 12165. PTFE seats. Gas threaded ends (BSP) M-free nut - ISO 228/1. Max. Temp. 110°C. Command with anti-fraud key.

r	R	ØP	L	A	M
G 1/2"	G 3/4"	13	35,5	63	48,5
G 3/4"	G 3/4"	17,5	37,5	65,5	48,5

3462 04 05	1/2" x 3/4"	0,260	8-96	-
3462 05 05	3/4" x 3/4"	0,330	8-96	-

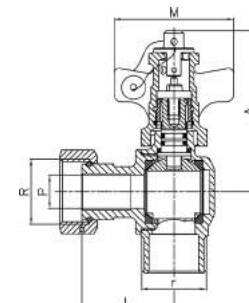

Ref. 3490

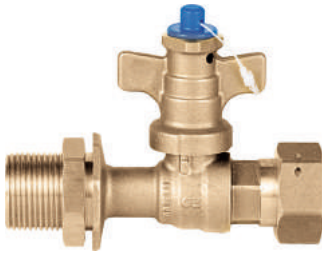

Válvula antifraude recta para caja de empotrar
 PN 25. Paso estándar. Construcción en latón UNE-EN 12165. Asientos PTFE. Extremos rosca gas (BSP) M (H)-tuerca loca - ISO 228/1. Temp. máx. 110°C. Mando manual mediante llave antifraude.

Against fraud straight valve for built-in box
 PN 25. Standard bore. Brass construction UNE-EN 12165. PTFE seats. Gas threaded ends (BSP) M (F)-free nut - ISO 228/1. Max. Temp. 110°C. Manual control with anti-fraud key.

r	R	ØP	L	A	M
G 3/4"	G 3/4"	13,5	97	63	48,5
G 3/4"	G 7/8"	13,5	97	63	48,5

CÓDIGO CODE	MEDIDA SIZE	PESO WEIGHT	CAJA / BOX CARTON	P.V.P. € PRICE €
3490 05 00	3/4" (1/2") x 3/4"	0,350	1	-

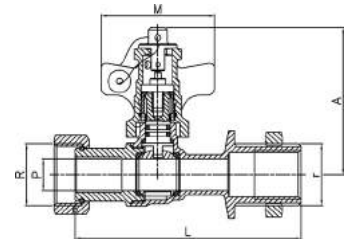

Ref. 3491



Racor recto con extensible
Straight connector with expanding

R	ØD	ØP	L
G 3/4"	G 3/4"	15	67-82
G 3/4"	G 7/8"	15	67-82

3491 05 05	3/4" (1/2") x 3/4"	240,000	1	-
------------	--------------------	---------	---	---

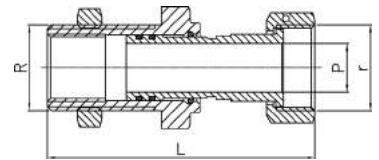

Ref. 3499



Llave accionamiento antifraude
Antitheft manual control key

Ref.	A	B
3499 00	67	65

3499 00	-	0,030	1	-
---------	---	-------	---	---

Precios a consultar / Prices on request

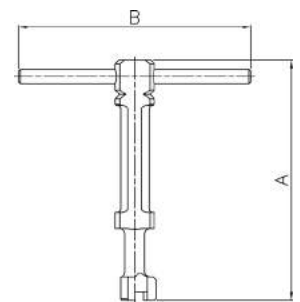



2018



2018





CLIMATIZACIÓN

CLIMATE CONTROL

**Válvulas de calefacción, de seguridad, motorizadas,
colectores, termostatos, válvulas para energía solar
y bombas de condensación.**

Heating valves, safety valves, motorized zone valves,
manifolds, thermostats, solar energy valves and condensate pumps.

CLIMATIZACIÓN CLIMATE CONTROL

SISTEMA DE CALEFACCIÓN GENEVRE GENEVRE HEATING SYSTEM

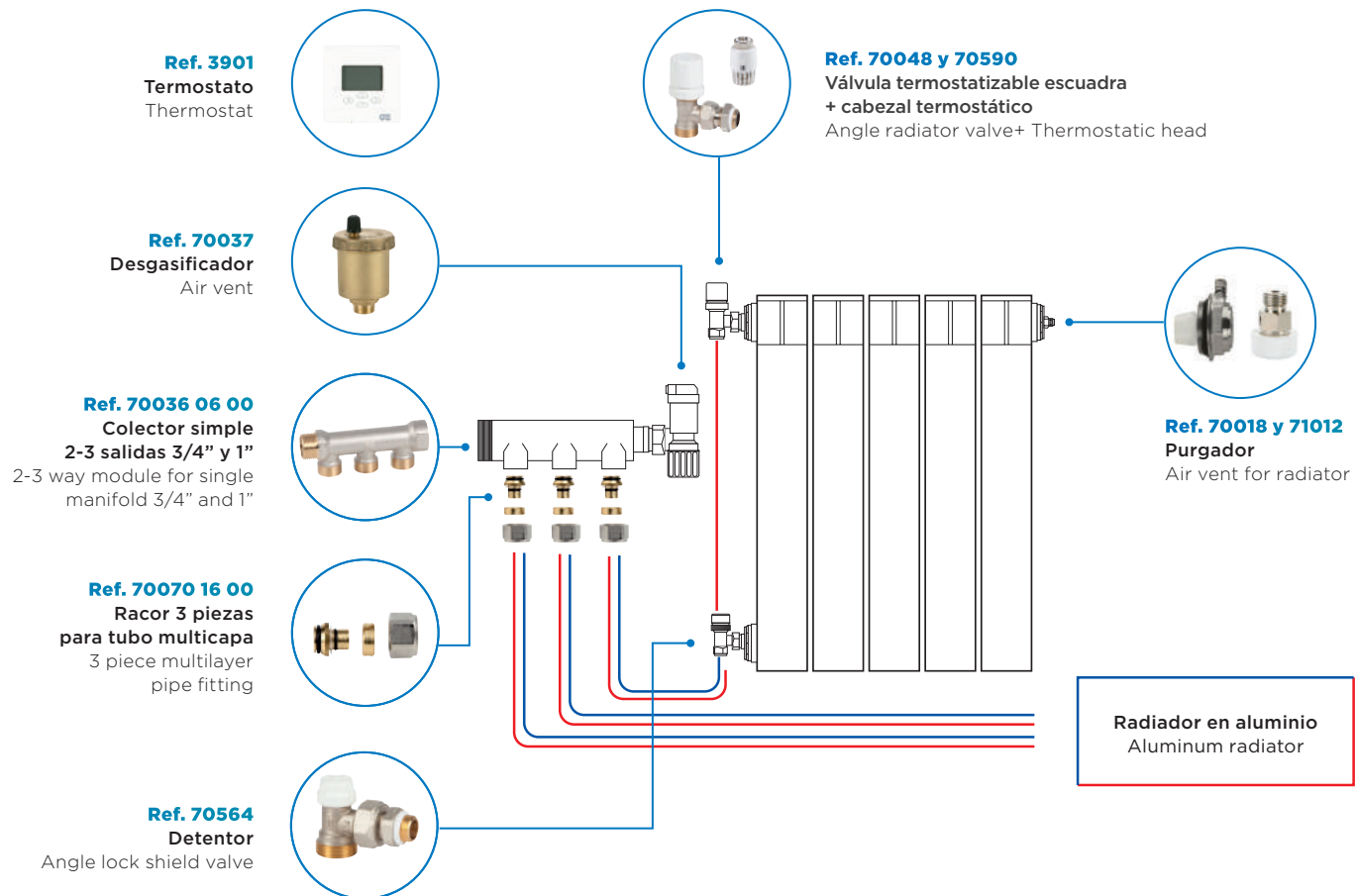

CARACTERÍSTICAS DE LAS VÁLVULAS

Para tubo hierro

Construcción en latón UNE-EN 12164-12165
Volante en ABS
Conexión a tubería (hembra) mediante rosca ISO 228/1
Conexión al emisor rosca macho ISO 228/1, con junta PTFE para Ge System
Temp. Máx. de trabajo 110°C
Presión máx. de trabajo 10 bar

Para tubo de cobre, PEX o multicapa

Construcción en latón UNE-EN 12164-12165
Volante en ABS
Conexión a tubería de cobre y plástico mediante racor de compresión* (ver enlaces de compresión)
Rosca macho W24,5 x 19h/1"
Conexión al emisor rosca macho ISO 228/1, con junta PTFE para Ge System
Temp. máx. trabajo 110°C
Presión máx. trabajo 10bar

VALVES CHARACTERISTICS

For steel pipes

Brass construction UNE-EN 12164-12165
ABS steering wheel
Pipe connection (female) thread ISO 228/1
Terminal connection male thread ISO 228/1, with PTFE joint for GE System
Max. working temp. 110°C
Max. working pressure 10 bar

For cooper, polyethylene or multilayer pipes

Brass construction UNE-EN 12164-12165
ABS steering wheel
Cooper and plastic connection by means a compression fitting* (see compression fittings)
Male thread W24,5 x 19h/1"
Terminal connection male thread ISO 228/1, with PTFE joint for GE System.
Max. working temp. 110°C
Max. working pressure 10bar

CLIMATIZACIÓN CLIMATE CONTROL

SISTEMA DE APRIETE GE-SYSTEM AIR TIGHT GE-SYSTEM

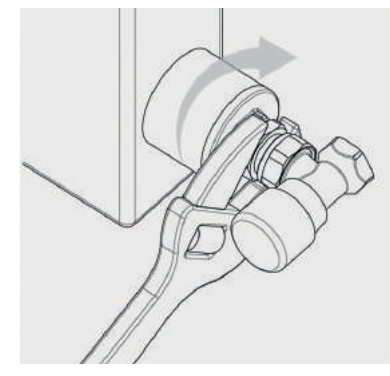
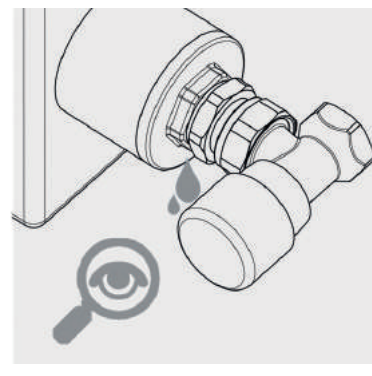
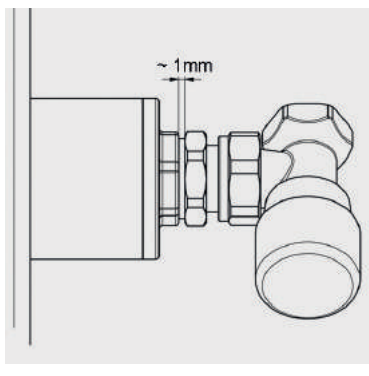
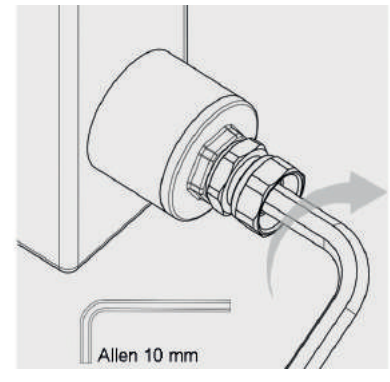
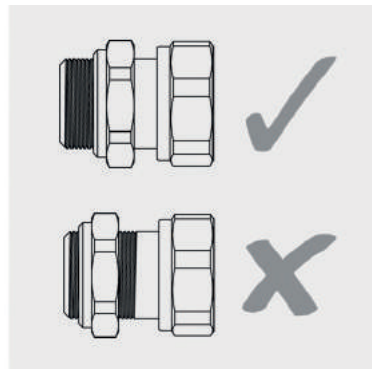
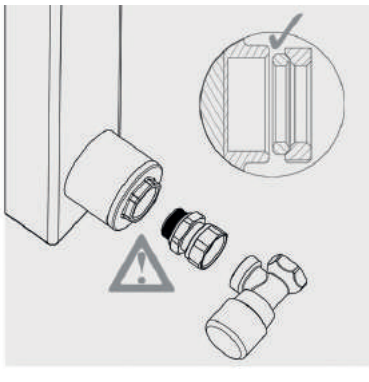

INSTALACIÓN

1. Comprobar compatibilidad del chaflán de los radiadores / tapón de radiador con el chaflán del anillo de PTFE.
2. Girar la contratuerca y el anillo de PTFE hasta hacer tope en la zona sin rosca del racor.
3. Roscar el racor en el tapón del radiador utilizando una llave Allen de 10mm.
4. Se considera un apriete correcto cuando la separación entre la contratuerca y el tapón del radiador es aproximadamente 1mm.
5. En caso de detectar una pérdida de agua en la conexión del racor al tapón, no es necesario desmontar la válvula.
6. Re-apretar la contratuerca hasta eliminar la pérdida de agua. Si la fuga persiste, poner cinta PTFE en la rosca macho del racor.

INSTALLATION

1. Check the compatibility between the radiator chamfer / radiator cap chamfer with the PTFE ring chamfer.
2. Turn the nut and the PTFE ring until it stops in the threaded fitting.
3. Thread the fitting on the radiator's cap using a 10mm Allen wrench.
4. A correct tightening is considered when the separation between the nut and the radiator cap is approximately 1 mm.
5. If a leakage of water is detected in the connection between the fitting and the radiator cap, it is not necessary to disassemble the valve.
6. Tighten the nut until the leakage stops. If the leakage persists, put PTFE tape on the male thread connector.



VÁLVULAS DE ESCUADRA Y RECTAS PARA TUBO HIERRO CON GE SYSTEM
 ANGLE AND STRAIGHT VALVES FOR STEEL PIPE WITH GE SYSTEM

CÓDIGO CODE	MEDIDA SIZE	PESO WEIGHT	CAJA / BOX CARTON	P.V.P. € PRICE €
----------------	----------------	----------------	----------------------	---------------------

Ref. **70151**

Válvula manual escuadra para tubo de hierro con GE System

Manual angle radiator valve for steel pipe with GE System

70151 03 00	3/8"	0,170	10-140	-
70151 04 00	1/2"	0,176	10-140	-



MED./SIZE	H	L
3/8"	69	50
1/2"	69	51

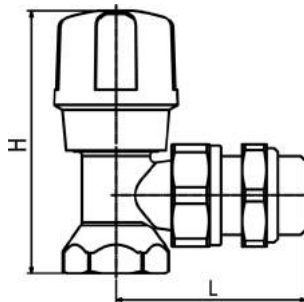

Ref. **70152**

Válvula manual recta para tubo de hierro con GE System

Manual straight radiator valve for steel pipe with GE System

70152 03 00	3/8"	0,190	10-140	-
70152 04 00	1/2"	0,214	10-140	-



MED./SIZE	L	H
3/8"	73	56
1/2"	76	56

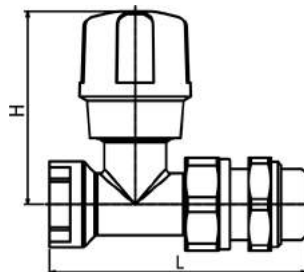

Ref. **70153**

Detentor escuadra para tubo de hierro con GE System

Angle adjusting lock shield valve for steel pipe with GE System

70153 03 00	3/8"	0,139	10-140	-
70153 04 00	1/2"	0,146	10-140	-



MED./SIZE	H	L
3/8"	50	48
1/2"	50	51

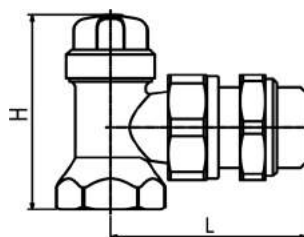

Ref. **70154**

Detentor recto para tubo de hierro con GE System

Straight adjusting lock shield valve for steel pipe with GE System

70154 03 00	3/8"	0,152	10-1	-
70154 04 00	1/2"	0,175	10-140	-



MED./SIZE	L	H
3/8"	73	29
1/2"	76	29

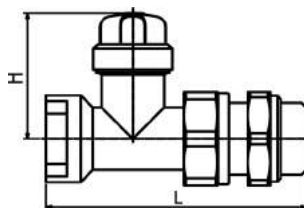

VÁLVULAS DE ESCUADRA Y RECTAS PARA TUBO COBRE-POLIETILENO-MULTICAPA CON GE SYSTEM
 ANGLE AND STRAIGHT VALVES FOR COPPER, POLYETHYLENE AND MULTILAYER PIPE WITH GE SYSTEM

CÓDIGO CODE	MEDIDA SIZE	PESO WEIGHT	CAJA / BOX CARTON	P.V.P. € PRICE €
----------------	----------------	----------------	----------------------	---------------------

Ref. **70587**

Válvula manual escuadra para tubo de cobre, PEX o multicapa con GE System

Manual angle radiator valve for cooper, polyethylene or multilayer pipe with GE System

MED./SIZE	H	L
3/8"	70	49
1/2"	70	52

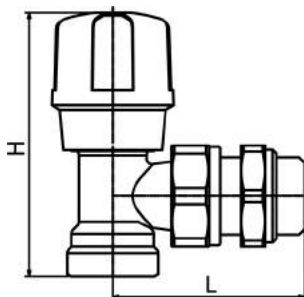

70587 03 00	3/8"	0,166	10-140	-
70587 04 00	1/2"	0,183	10-140	-



Ref. **70588**

Válvula manual recta para tubo de cobre, PEX o multicapa con GE System

Manual straight radiator valve for cooper, polyethylene or multilayer pipe with GE System

MED./SIZE	L	H
3/8"	74	56
1/2"	77	56

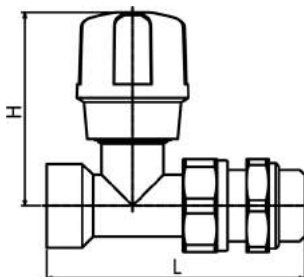

70588 03 00	3/8"	0,190	10-140	-
70588 04 00	1/2"	0,205	10-140	-



Ref. **70564**

Detentor escuadra para tubo cobre, PEX o multicapa con GE System

Angle lock shield valve for copper, PEX or multilayer pipe with GE System

MED./SIZE	L	H
3/8"	50	50
1/2"	52	50

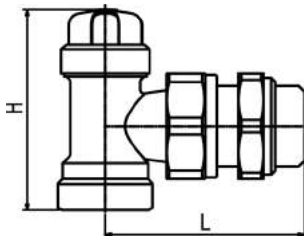

70564 03 00	3/8"	0,137	10-140	-
70564 04 00	1/2"	0,153	10-140	-



Ref. **70565**

Detentor recto para tubo cobre, PEX o multicapa con GE System

Straight lock shield valve for copper, PEX or multilayer pipe with GE System

MED./SIZE	L	H
3/8"	74	29
1/2"	74	29

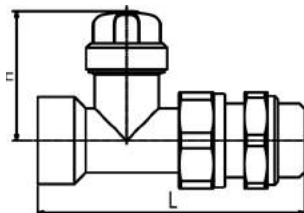

70565 03 00	3/8"	0,170	10-140	-
70565 04 00	1/2"	0,180	10-140	-



VÁLVULAS DE ESCUADRA Y RECTAS PARA TUBO HIERRO
ANGLE AND STRAIGHT VALVES FOR STEEL PIPE

CÓDIGO CODE	MEDIDA SIZE	PESO WEIGHT	CAJA / BOX CARTON	P.V.P. € PRICE €
----------------	----------------	----------------	----------------------	---------------------

Ref. **70151**

Válvula manual escuadra para tubo de hierro

Manual angle radiator valve for steel pipe

70151 03 40	3/8"	0,160	10-140	-
70151 04 40	1/2"	0,160	10-140	-



MED./SIZE	H	L
3/8"	69	50
1/2"	69	51

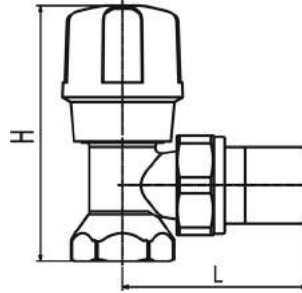

Ref. **70152**

Válvula manual recta para tubo de hierro

Manual straight radiator valve for steel pipe

70152 03 40	3/8"	0,167	10-140	-
70152 04 40	1/2"	0,180	10-140	-



MED./SIZE	L	H
3/8"	73	56
1/2"	76	56

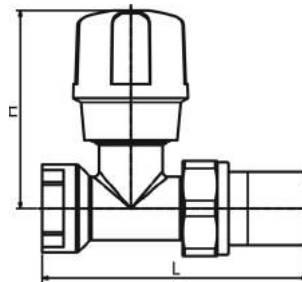

Ref. **70153**

Detentor escuadra para tubo de hierro

Angle adjusting lock shield valve for steel pipe

70153 03 40	3/8"	0,140	10-140	-
70153 04 40	1/2"	0,140	10-140	-



MED./SIZE	H	L
3/8"	50	48
1/2"	50	51

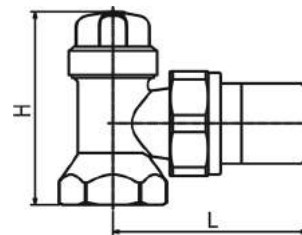

Ref. **70154**

Detentor recto para tubo de hierro

Straight adjusting lock shield valve for steel pipe

70154 03 40	3/8"	0,160	10-140	-
70154 04 40	1/2"	0,160	10-140	-



MED./SIZE	L	H
3/8"	73	29
1/2"	76	29

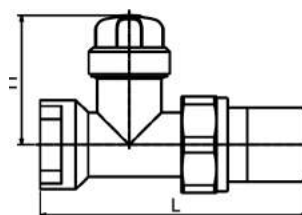

VÁLVULAS DE ESCUADRA Y RECTAS PARA TUBO COBRE-POLIETILENO-MULTICAPA
 ANGLE AND STRAIGHT VALVES FOR COPPER, POLYETHYLENE AND MULTILAYER PIPE

CÓDIGO CODE	MEDIDA SIZE	PESO WEIGHT	CAJA / BOX CARTON	P.V.P. € PRICE €
----------------	----------------	----------------	----------------------	---------------------

Ref. **70587**

Válvula manual escuadra para tubo de cobre, PEX o multicapa

Manual angle radiator valve for cooper, polyethylene or multilayer pipe

70587 03 40	3/8"	0,155	10-140	-
70587 04 40	1/2"	0,170	10-140	-



MED./SIZE	H	L
3/8"	70	49
1/2"	70	52

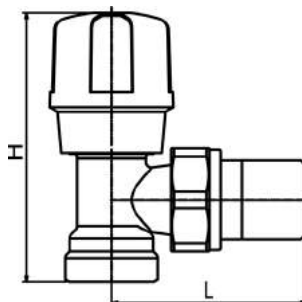

Ref. **70588**

Válvula manual recta para tubo de cobre, PEX o multicapa

Manual straight radiator valve for cooper, polyethylene or multilayer pipe

70588 03 40	3/8"	0,175	10-140	-
70588 04 40	1/2"	0,190	10-140	-



MED./SIZE	L	H
3/8"	74	56
1/2"	77	56

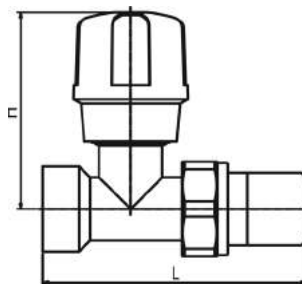

Ref. **70564**

Detentor escuadra para tubo cobre, PEX o multicapa

Angle lock shield valve for copper, PEX or multilayer pipe

70564 03 40	3/8"	0,135	10-140	-
70564 04 40	1/2"	0,145	10-140	-



MED./SIZE	L	H
3/8"	50	50
1/2"	52	50

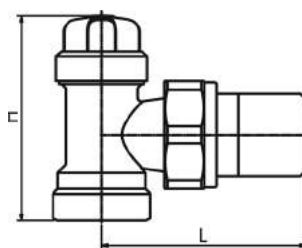

Ref. **70565**

Detentor recto para tubo cobre, PEX o multicapa

Straight lock shield valve for copper, PEX or multilayer pipe

70565 03 40	3/8"	0,155	10-140	-
70565 04 40	1/2"	0,165	10-100	-



MED./SIZE	L	H
3/8"	74	29
1/2"	74	29

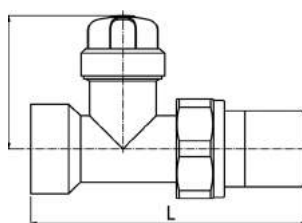

VÁLVULAS TERMOSTATIZABLES DE ESCUADRA Y RECTAS PARA TUBO HIERRO
 ANGLE AND STRAIGHT THERMOSTATIC VALVES FOR STEEL PIPE

CÓDIGO CODE	MEDIDA SIZE	PESO WEIGHT	CAJA / BOX CARTON	P.V.P. € PRICE €
----------------	----------------	----------------	----------------------	---------------------

Ref. **70031**

Válvula termostatizable escuadra para tubo de hierro con GE System

70031 03 00	3/8"	0,200	10-80	-
70031 04 00	1/2"	0,250	10-80	-

Angle radiator valve with thermostatic option, for steel pipe with GE System



MED./SIZE	H	L
3/8"	83	48
1/2"	83	51

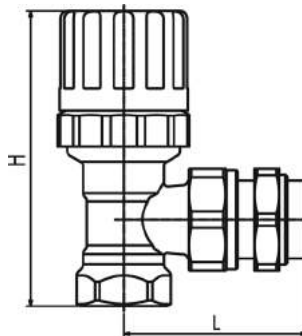

Ref. **70032**

Válvula termostatizable recta para tubo de hierro con GE System

70032 03 00	3/8"	0,250	10-80	-
70032 04 00	1/2"	0,250	10-80	-

Straight radiator valve with thermostatic option, for steel pipe with GE System



MED./SIZE	L	H
3/8"	73	70
1/2"	76	70

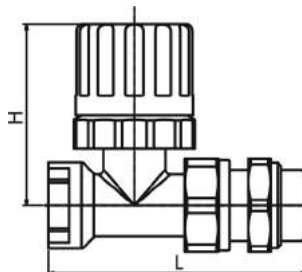

Ref. **70153**

Detentor escuadra para tubo de hierro con GE System

70153 03 00	3/8"	0,139	10-140	-
70153 04 00	1/2"	0,146	10-140	-

Angle adjusting lock shield valve for steel pipe with GE System



MED./SIZE	H	L
3/8"	50	48
1/2"	50	51

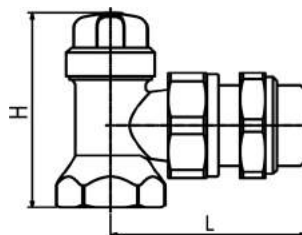

Ref. **70154**

Detentor recto para tubo de hierro con GE System

70154 03 00	3/8"	0,152	10-1	-
70154 04 00	1/2"	0,175	10-140	-

Straight adjusting lock shield valve for steel pipe with GE System



MED./SIZE	L	H
3/8"	73	29
1/2"	76	29

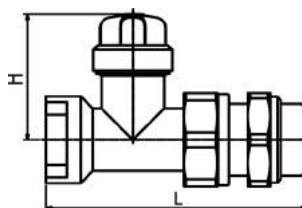

VÁLVULAS TERMOSTATIZABLES DE ESCUADRA Y RECTAS PARA TUBO COBRE-POLIETILENO-MULTICAPA
 ANGLE AND STRAIGHT THERMOSTATIC VALVES FOR COPPER, POLYETHYLENE AND MULTILAYER PIPE

CÓDIGO CODE	MEDIDA SIZE	PESO WEIGHT	CAJA / BOX CARTON	P.V.P. € PRICE €
----------------	----------------	----------------	----------------------	---------------------

Ref. **70048**

Válvula termostatizable escuadra para tubo cobre, polietileno o multicapa con GE System

70048 03 00	3/8"	0,212	10-80	-
70048 04 00	1/2"	0,229	10-80	-

Angle radiator valve with thermostatic option, for copper or polyethylene pipe with GE System



MED./SIZE	H	L
3/8"	84	49
1/2"	84	52

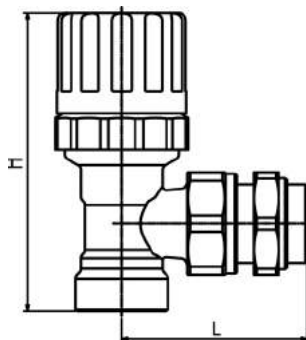

Ref. **70049**

Válvula termostatizable recta para tubo cobre, polietileno o multicapa con GE System

70049 03 00	3/8"	0,230	10-100	-
70049 04 00	1/2"	0,250	10-100	-

Straight radiator valve with thermostatic option, for copper or polyethylene pipe with GE System



MED./SIZE	L	H
3/8"	74	70
1/2"	77	70

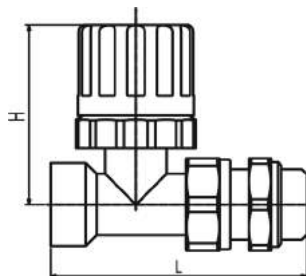

Ref. **70564**

Detentor escuadra para tubo cobre, PEX o multicapa con GE System

70564 03 00	3/8"	0,137	10-140	-
70564 04 00	1/2"	0,153	10-140	-

Angle lock shield valve for copper, PEX or multilayer pipe with GE System



MED./SIZE	L	H
3/8"	50	50
1/2"	52	50

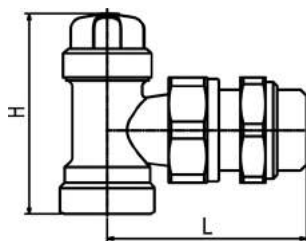

Ref. **70565**

Detentor recto para tubo cobre, PEX o multicapa con GE System

70565 03 00	3/8"	0,170	10-140	-
70565 04 00	1/2"	0,180	10-140	-

Straight lock shield valve for copper, PEX or multilayer pipe with GE System



MED./SIZE	L	H
3/8"	74	29
1/2"	74	29

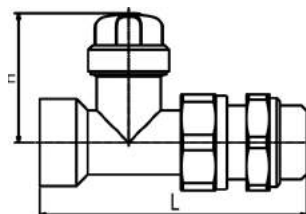

Ref. 70590



Cabezal termostático

Uso para válvulas termostaticables. Construcción en ABS ignífugo. Rango de temperaturas de 6°C a 28°C con dispositivo antihielo. Sensor líquido de expansión por calor. Conexión rosca M30 x 1,5. Presión máx. de trabajo 10 bar. Temp. máx. de trabajo 50°C. Dimensiones 81 x Ø 48.

Thermostatic head

For thermostatic valves use. ABS fireproof construction. Temperature range from 6°C to 28°C with defrosting device. Liquid sensor heat expansion. Thread connection M30 x 1,5. Max. working pressure 10 bar. Max. working temp. 50°C. Dimensions 81 x Ø 48.

CÓDIGO CODE	MEDIDA SIZE	PESO WEIGHT	CAJA / BOX CARTON	P.V.P. € PRICE €
70590 00 00	M30 x 1,5	0,130	1-144	-

Ref. 72501

NEW



Cabezal termostático programable para radiadores

Uso para válvulas termostaticables. Alimentación con dos baterías 1,5V tipo AA. Funcionamiento automático con dos niveles de temperatura (confort o económico) o manual mediante la rueda de selección. Temperatura de funcionamiento de 0°C a 55°C. Temperatura de protección antihielo 6°C. Grado de protección IP30. Dimensiones 52x83x56cm

Programmable thermostatic head for radiators

For thermostatic valves use. Power supply two batteries 1,5V AA. Automatic operation with two levels of temperature (comfort or economic) or manual through the selection wheel. Working temperature from 0°C to 55°C. Antifreeze against 6°C. IP30. Dimensions 52x83x56cm

72501 00 00	-	0,164	-	-
-------------	---	-------	---	---

Ref. 70306



Cabezal electrotérmico para válvulas termostaticables

Alimentación: 24/230V. Construcción en ABS ignífugo. Sensor de cera electrotérmico. Cable de dos hilos. Posición de la válvula n/c. Clase de protección IP 40. Temp. máx. de trabajo 50°C. Presión máxima de trabajo 10 bar.

Electrothermal control for thermostatic valves

Power supply: 24/230V. ABS fireproof construction. Electrothermal wax sensor. Two wire cable. Normally closed valve position. Protection class IP 40. Max. working pressure 10 bar.

70306 00 02	M30 x 1,5	0,100	1-100	-
70306 00 12	M30 x 1,5	0,115	1-100	-

Ref.	Alimentación/ Power supply
70306 00 02	220/230 V
70306 00 12	24 V

Ref. 70585

NEW



Válvula monotubo simple

Construcción en latón UNE-EN 12164-12165. Juntas de cierre en elastómetro. Volante en ABS. Conexión al emisor rosca macho ISO 228/1. Conexión a tubería de cobre y plástico mediante racor. Rosca macho W24,5 x 19h/1". Temp. máx. de trabajo 100°C. Presión máx. de trabajo 10 bar.

Valve for single-pipe installation

Brass construction UNE-EN 12164-12165. Elastomer sealing joints. ABS steering wheel. Terminal connection male thread ISO 228/1. Cooper and plastic connection by means a fitting. Male thread W24,5 x 19h/1". Max. working temp. 100°C. Max. working pressure 10 bar.

70585 04 00	1/2"	0,200	-	-
-------------	------	-------	---	---

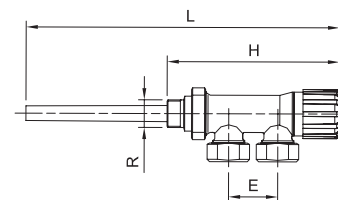

MED./SIZE	L	H	E	R
1/2"	236	117	37	1/2"

CÓDIGO CODE	MEDIDA SIZE	PESO WEIGHT	CAJA / BOX CARTON	P.V.P. € PRICE €
----------------	----------------	----------------	----------------------	---------------------

Ref. 71028



Válvula monotubo termostatizable

Construcción en latón UNE-EN 12164-12165. Juntas de cierre en elastómero. Volante en ABS. Conexión al emisor rosca macho ISO 228/1. Conexión a tubería de cobre y plástico mediante racor. Rosca macho W24,5 x 19h/1". Mando manual intercambiable. Sonda de entrada incorporada. Temp. máx. de trabajo 110°C. Presión máx. de trabajo 10 bar.

Thermostatic valve for single-pipe installation

Brass construction UNE-EN 12164-12165. Elastomer sealing joints. ABS steering wheel. Terminal connection male thread ISO 228/1. Cooper and plastic connection by means a fitting. Male thread W24,5 x 19h/1". Easy replaceable manual control. Inlet probe incorporated. Max. working temp. 110°C. Max. working pressure 10 bar.

71028 04 00	1/2"	0,487	4-48	-
-------------	------	-------	------	---

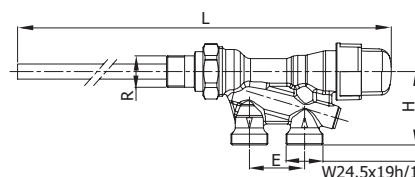

MED./SIZE	L	H	E	D
1/2"	146	49	35	258

Ref. 75404

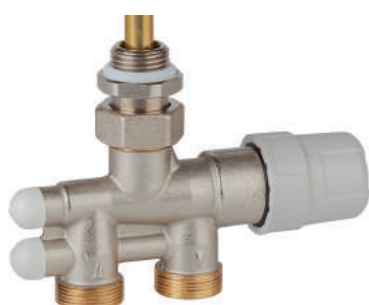

Válvula monotubo termostatizable 4 vías para radiador

Construcción en latón UNE-EN 12164-12165. Juntas de cierre en elastómero. Volante en ABS. Conexión al emisor rosca macho ISO 228/1. Conexión a tubería de cobre y plástico mediante racor. Rosca macho W24,5 x 19h/1". Mando manual intercambiable. Sonda de entrada incorporada. Temp. máx. de trabajo 110°C. Presión máx. de trabajo 10 bar.

4 ways valve with thermostatic option for radiators

Brass construction UNE-EN 12164-12165. Elastomer sealing joints. ABS steering wheel. Terminal connection male thread ISO 228/1. Cooper and plastic connection by means a fitting. Male thread W24,5 x 19h/1". Easy replaceable manual control. Inlet probe incorporated. Max. working temp. 110°C. Max. working pressure 10 bar.

75404 04 00	1/2"	0,475	-	-
-------------	------	-------	---	---

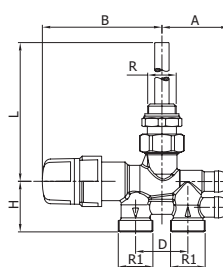

MED./SIZE	R	R1	L	H	A	B	D
1/2"	1/2"	W24,5x19h/1"	353	36	47.5	85	37

Ref. 70177



Codo para conexión válvula monotubo

Construcción en latón niquelado UNE-EN 12165. Junta de EPDM peróxido. Rosca Macho - Hembra W24,5 x 19h/1". Temp. máx. de trabajo 110°C. Presión máx. de trabajo 10 bar.

Elbow fitting for valve-pipe connection

Nickel-plated brass construction UNE-EN 12165. EPDM PEROX seal. Male - Female thread W24,5 x 19h/1". Max. working temp. 110°C. Max. working pressure 10 bar.

70177 00 00	W24,5 x 19h"	0,085	-	-
-------------	--------------	-------	---	---

Ref. 70041



Racor tubo cobre

Tuerca y casquillo en latón. Tuerca niquelada. Junta de cierre en NBR. Rosca hembra W24,5 x 19h/1". Temp. máx. de trabajo 95°C. Presión máx. de trabajo 10 bar.

Copper pipe fitting

Nut and ring in brass. Nickel-plated nut. NBR sealing joint. Female thread W24,5 x 19h/1". Max. working temp. 95°C. Max. working pressure 10 bar.

70041 12 20	Ø 12	0,044	10-300	-
70041 15 20	Ø 15	0,039	10-300	-

Ref. 70071



Racor tubo polietileno reticulado (PEX)

Construcción en latón. Tuerca niquelada. Junta de cierre en NBR. Rosca hembra W24,5 x 19h/1". Temperatura máxima de trabajo 95°C. Presión máxima de trabajo 10 bar.

PEX polyethylene pipe fitting

Brass construction. Nickel-plated nut. NBR sealing joint. Female thread w24,5 x 19h/1". Maximum working temperature 95°C. Maximum working pressure 10 bar.

70071 16 00	Ø 16 x 2	0,060	10-300	-
70071 16 20	Ø 16 x 1,5	0,055	10-300	-

Ref. 70070



Racor tubo multicapa

Construcción en latón. Tuerca niquelada. Juntas de cierre en NBR. Rosca hembra W24,5 x 19h/1". Temp. máx. de trabajo 95°C. Presión máx. de trabajo 10 bar.

Multilayer pipe fitting

Brass construction. Nickel-plated nut. NBR sealing joints. Female thread W24,5 x 19h/1". Max. working temp. 95°C. Max. working pressure 10 bar.

CÓDIGO CODE	MEDIDA SIZE	PESO WEIGHT	CAJA / BOX CARTON	P.V.P. € PRICE €
70070 16 00	Ø 16 x 2	0,051	10-300	-
70070 18 00	Ø 18 x 2	0,050	10-300	-
70070 20 00	Ø 20 x 2	0,065	10-300	-
70070 20 20	Ø 20 x 2,25	0,068	10-300	-

Ref. 3179 - 3189



Válvula de seguridad escuadra-3 bar (3179)

Válvula de seguridad escuadra-6 bar (3189)

Cuerpo en latón. Muelle de acero INOX AISI 302. Obturador en EPDM. Membrana en EPDM. Extremos roscados hembra-hembra ISO 228/1. Presión máx. de trabajo 10 bar. Temp. máx. 90°C.

Safety relief angle valve-3 bar (3179)

Safety relief angle valve-6 bar (3189)

Brass body. Stainless steel AISI 302 spring. EPDM joint. EPDM membrane. Female-female threaded ends ISO 228/1. Max. working pressure 10 bar. Max. working temp. 90°C.

3179 04	1/2"	0,116	10-100	-
3189 04	1/2"	0,116	10-100	-

Ref. 3182 - 3188



Válvula de seguridad escuadra-3 bar (3182)

Válvula de seguridad escuadra-6 bar (3188)

Cuerpo en latón. Muelle de acero inox AISI 302. Obturador en EPDM. Membrana en EPDM. Extremos roscados macho-hembra ISO 228/1. Presión máx. de trabajo 10 bar. Temperatura máx. 90°C.

Safety relief angle valve-3 bar (3182)

Safety relief angle valve-6 bar (3188)

Brass body. Stainless steel AISI 302 spring. EPDM joint. EPDM membrane. Female-female threaded ends ISO 228/1. Max. working pressure 10 bar. Max. working temp. 90°C.

3182 04	1/2"	0,118	10-100	-
3188 04	1/2"	0,118	10-100	-

Ref. 3191 - 3192



Válvula de seguridad escuadra con conexión manómetro-3 bar (3191)

Válvula de seguridad escuadra con conexión manómetro-6 bar (3192)

Cuerpo en latón. Muelle de acero INOX AISI 302. Obturador en EPDM. Membrana en EPDM. Extremos roscados macho-hembra ISO 228/1. Presión máx. de trabajo 10 bar. Temp. máx. 90°C. Conexión para manómetro hembra 1/4" ISO 228/1.

Safety relief angle valve with pressure gauge connection-3 bar (3191)

Safety relief angle valve with pressure gauge connection-6 bar (3192)

Brass body. Stainless steel AISI 302 spring. EPDM joint. EPDM membrane. Male-female threaded ends ISO 228/1. Max. working pressure 10 bar. Max. working temp. 90°C. 1/4" female pressure gauge connection ISO 228/1.

3191 04	1/2"	0,114	10-100	-
3192 04	1/2"	0,114	10-100	-

Ref. 3191E - 3192E

NEW



Válvula de seguridad con conexión y manómetro 3 bar (3191E)

Válvula de seguridad con conexión y manómetro 6 bar (3192E)

PN 10. Construcción en latón UNE-EN 12165. Muelle de acero inoxidable AISI 302. Obturador y membrana en EPDM. Extremos roscados M-H ISO 228/1. Temp. máx. 90°C. Mando manual por volante de ABS. Manómetro Ø 53 indicador rojo, salida posterior.

Safety relief angle valve with pressure gauge 3 bar (3191E) Safety relief angle valve with pressure gauge 6 bar (3192E)

PN 10. Brass construction UNE-EN 12165. Stainless steel AISI 302 spring. EPDM joint and membrane. Threaded ends ISO 228/1 M-F. Max. temp. 90°C. ABS manual handwheel. Pressure gauge Ø 53, red index, back connection.

3191E 04	1/2"	0,181	-	-
3192E 04	1/2"	0,181	-	-

CÓDIGO MEDIDA PESO CAJA / BOX P.V.P. €
CODE SIZE WEIGHT CARTON PRICE €

Ref. 73153

NEW

Unidad automática de llenado a pistón

PN 16. Construcción en latón niquelado UNE-EN 12165. Cierre acero inox. Extremos rosca gas (BSP) M-H s/ISO 228/1. Campo de regulación 0,5 - 4 bar. Manómetro conexión G1/4" escala 0-10 bar. Valvula antiretorno en el interior. Valvula de corte de suministro. Temperatura máxima de trabajo 80°C. Aplicación para agua

Automatic piston filling unit

PN 16. Nickel-plated brass construction UNE-EN 12165. Stainless steel sealing. Threaded ends gas (BSP) M - F acc/ISO 228/1. Adjustable range from 0,5 - 4 bar. Pressure gauge scale 0 - 10 bar with G1/4" connection. Inner check valve. Shut-off valve of power supply. Working temperature 80°C. Appliance for water

R	A	B	C	D
1/2"	55	55,7	46	59,6



73153 04 00	1/2"	0,542	-	-
-------------	------	-------	---	---

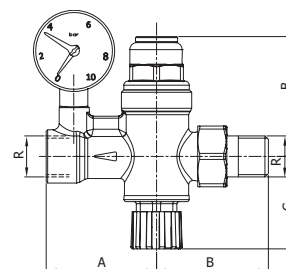

Ref. 70017

Purgador manual de aire orientable

PN 10. Construcción en latón UNE-EN 12164 niquelado. Juntas de cierre en EPDM. Orificio de purga orientable 360°. Conexión rosca gas (BSP) macho ISO 228/1. Temp. máx. trabajo 100°C.

Orientable manual air vent

PN 10. Nickel plated brass construction UNE-EN 12164. EPDM sealing O-rings. Vent hole orientable 360°. Gas threaded end (BSP) male, ISO 228/1. Max. working temp. 100°C

R	A	B	C	E (Hex)
1/8"	13	21	24	14



70017 01 00	1/8"	0,020	100-1000	-
-------------	------	-------	----------	---

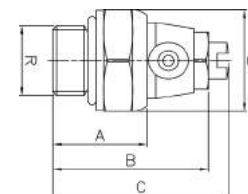

Ref. 70018

Purgador manual de aire

Cuerpo en latón niquelado. Mando de control no conductor de calor. Unión rosca macho ISO 228. Presión máx. 6 bar. Temp. máx 100°C.

Manual air vent

Nickel-plated brass body. Heatless control handle. Threads connection male ISO 228. Max. working pressure 6 bar. Max. working temp. 100°C.

R	D	A
1/8"	17,5	27



70018 01 02	1/8"	0,017	10-1000	-
-------------	------	-------	---------	---

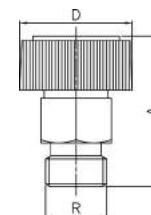

Ref. 71012

Purgador automático de aire

Cuerpo en latón niquelado. Junta en EPDM. Flotador en polietileno. Unión rosca M-ISO 228. Presión máx. 10 bar. Temp. máx. de trabajo 110°C.

Automatic air vent valve

Nickel-plated brass body. EPDM joint. Polyethylene float. Male thread connections ISO 228. Max. working pressure 10 bar. Max. working temp. 110°C.

R	A	B	C	D
G 1"	57,5	31	37,5	42



71012 06 02	DCHO./RIGHT	0,102	10-100	-
71012 06 13	IZQ./LEFT	0,102	10-100	-

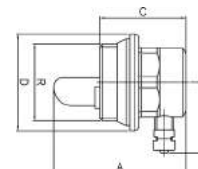

Ref. 70037

Purgador automático de aire

Cuerpo en latón. Sistema de flotador en PP. Junta de cierre en elastómero. Extremo rosca macho ISO 228/1. Temp. máx. 110°C. Presión máxima de trabajo 10 bar.

Automatic air vent

Body brass. PP floating system. Elastomer sealing joint. Male thread ISO 228/1. Max. working temp. 110°C. Maximum working pressure 10 bar.

R	A	D	H
G 3/8"	75	46	60
G 1/2"	74	46	60
G 3/4"	73	46	59
G 1"	99	51	85



70037 03 02	3/8"	0,200	1-192	-
70037 04 02	1/2"	0,150	1-192	-
70037 05 02	3/4"	0,150	1-192	-
70037 06 02	1"	0,300	10-100	-

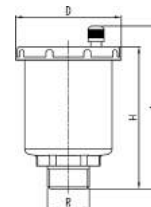

Ref. 70038



Purgador automático de aire con cierre manual y conexión lateral
Cuerpo en latón. Sistema de flotador en PP. Junta de cierre en elastómero. Extremo rosca macho ISO 228/1. Temp. máx. 115°C.

Automatic air vent with manual lockin plug and lateral connection
Body brass. PP floating system. Elastomer sealing joint. Male thread ISO 228/1. Max. working temp. 115°C.

R	A	D	H	L
G 3/8"	53	46	46	53
G 1/2"	53	46	46	55

CÓDIGO CODE	MEDIDA SIZE	PESO WEIGHT	CAJA / BOX CARTON	P.V.P. € PRICE €
70038 03 00	3/8"	0,026	10-80	-
70038 04 00	1/2"	0,047	10-80	-

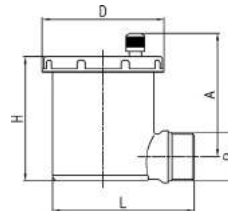

Ref. 70037



Degasificador automático
Cuerpo en latón niquelado. Flotador en PP. Junta de cierre en elastómero. Extremo rosca macho ISO 228/1. Temperatura máx. fluido 100°C. Presión máx. trabajo 6 bar. Presión máx. transitoria 16 bar.

Automatic degassing device
Nickle-plated brass body. PP float. Elastomer sealing joint. Male thread end ISO 228/1. Max. fluid temperature 100°C. Max. working pressure 6 bar. Max. transient pressure 16 bar.

MED./SIZE	A	D
3/8"	112	48
1/5"	114	48
3/4"	116	48

70037 03 60	3/8"	0,245	10-50	-
70037 04 60	1/2"	0,255	10-80	-
70037 05 60	3/4"	270,000	10-100	-

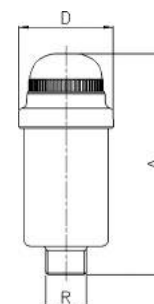

Ref. 70024

NEW



Colector simple componible 2, 3 y 4 vías
PN 10. Construcción en latón niquelado UNE-EN 12165. Conexión en línea rosca gas (BSP) M - H, ISO 228/1. Conexión derivación macho, G1/2" ISO 228/1. Máxima temperatura de trabajo 180°C.

2, 3 and 4 ways modular single manifold
PN 10. Nickel-plated brass construction UNE-EN 12165. Line connection threaded ends gas (BSP) M - F, ISO 228/1. Lateral connections male, G1/2" ISO 228/1. Maximum working temperature 180°C.

R	salidas / ways	DN	L	X
3/4"	2	20	85	36
3/4"	3	20	121	36
3/4"	4	20	157	36
1"	2	25	104	42
1"	3	25	146	42
1"	4	25	188	42

70024 05 02	3/4"	0,153	8-64	-
70024 05 03	3/4"	0,199	5-40	-
70024 05 04	3/4"	0,237	4-32	-
70024 06 02	1"	0,250	8-64	-
70024 06 03	1"	0,332	5-40	-
70024 06 04	1"	412,000	4-32	-

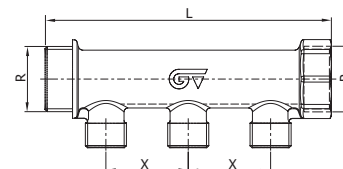

Ref. 70035



Colector simple componible 2, 3 y 4 vías
Construcción en latón niquelado UNE-EN 12165. Conexión en derivación lateral rosca macho W24,5 x 19h/1". Conexión en línea rosca macho, hembra ISO 228/1. Temperatura máxima de trabajo: 180°C. Presión máxima de trabajo: 10 bar.

2, 3 and 4 ways module single manifold
Nickle-plated brass construction UNE-EN 12165. Lateral branch connection male thread W24,5 x 19h/1". Threaded ends connection male-female ISO 228/1. Maximum working temperature: 180°C. Maximum working pressure: 10 bar.

R	N.º Derivaciones/ Branches num.	DN	L	X
3/4"	2	20	87	36
3/4"	3	20	123	36
3/4"	4	20	159	36
1"	2	25	105	42
1"	3	25	147	42
1"	4	25	189	42

70035 05 02	3/4"	0,200	8-64	-
70035 05 03	3/4"	0,264	5-40	-
70035 05 04	3/4"	0,326	4-32	-
70035 06 02	1"	0,314	8-64	-
70035 06 03	1"	0,427	5-40	-
70035 06 04	1"	0,545	4-32	-

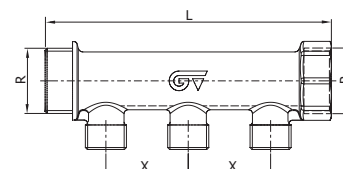

CÓDIGO MEDIDA PESO CAJA / BOX P.V.P. €
CODE SIZE WEIGHT CARTON PRICE €

Ref. 70171



Colector simple componible sanitario con regulación 2, 3 y 4 vías
Construcción en latón niquelado. Juntas en elastómero. Volante en ABS antirrobo. Conexión en derivación lateral rosca macho W24,5 x 19h/1". Conexión en línea rosca macho, hembra ISO 228/1. Temperatura máxima de trabajo: 110°C. Presión máxima de trabajo: 10 bar. Con placa reversible indicadora de agua fría (azul) y caliente (roja).

2, 3 and 4 ways modular sanitary manifold with adjustment
Nickle-plated brass construction. Elastomer joints. ABS against steering wheel. Lateral branch connection male thread W24,5 x 19h/1". Threaded ends connection male-female ISO 228/1. Maximum working temperature: 110°C. Maximum working pressure: 10 bar. With reversible metal sheet which indicates cold water (blue) and hot water (red).

R	N.º Derivaciones/ Branches num.	DN	L	X
3/4"	2	20	88	36
3/4"	3	20	124	36
3/4"	4	20	160	36
1"	2	25	101	43
1"	3	25	144	43
1"	4	25	187	43

70171 05 02	3/4"	0,386	5-40	-
70171 05 03	3/4"	0,538	5-30	-
70171 05 04	3/4"	0,701	4-24	-
70171 06 02	1"	0,475	5-40	-
70171 06 03	1"	0,688	5-30	-
70171 06 04	1"	0,917	4-24	-

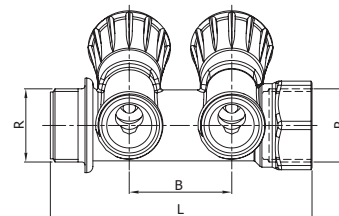

Ref. 70176

NEW



Colector de distribución AISI 304
Tubo de 1", salidas de 1/2".

Manifold double side AISI 304
1" pipe, 1/2" outlets.

70176 06 04	1"	-	1	-
70176 06 05	1"	-	1	-
70176 06 06	1"	-	1	-
70176 06 07	1"	-	1	-
70176 06 08	1"	-	1	-

Ref. 70069

NEW



Llave para fitting

Llave con conexión angular de 1/2" para apretar fácilmente en montaje en cualquier posición.

Spanner for fitting

Angled 1/2" connection, for easily tighten fitting in any position.

70069 00 00	CH30	0,240	-	-
-------------	------	-------	---	---

Ref. 70042

NEW



Tapon para colectores

Construcción en latón niquelado UNE-EN 12165. Junta de PTFE. Rosca hembra W24,5 x 19h/1". Temp. máx. de trabajo 110°C. Presión máx. de trabajo 10 bar.

Blind cap for manifold

Nickle-plated brass construction UNE-EN 12165. PTFE seal. Female thread W24,5 x 19h/1". Max. working temp. 110°C. Max. working pressure 10 bar

70042 00 00	W24,5 x 19h"	0,032	-	-
-------------	--------------	-------	---	---

Ref. 72606

NEW



Caja metálica para colectores componibles

Caja de inspección con cuerpo de acero galvanizado. Tapa extraíble de material plástico pintable. Con guías móviles.

Metal box fo modular manifold

Metal galvanized box. Removable cover in pintable plastic. With mobile bracket guides inside.

72606 40 02	400x500	-	-	-
72606 60 02	600x500	-	-	-
72606 80 02	800x500	-	-	-

Ref. 72190 06

NEW

Bridas metálicas para colectores

Par de bridas de acero para fijar los colectores en cajas metálicas. Distancia entre centros 220 mm.

CÓDIGO CODE	MEDIDA SIZE	PESO WEIGHT	CAJA / BOX CARTON	P.V.P. € PRICE €
72190 06 00	1"	0,682	-	-



Steel brackets for manifold

Pair of steel brackets to fixing the manifolds in metal boxes. Center distances 220 mm.

Ref. 70874

NEW

Válvula de equilibrado

PN 16. Construcción en latón s/UNE-EN 12165. Cartucho de polímero con membrana de EPDM. Extremos rosca gas (BSP) H - H s/ISO 228/1. Indicador mediante escala graduada. Tomas de presión roscadas G1/8" hembra. Temperatura de trabajo de - 20°C a 120°C. Aplicación con agua y agua + glicol (50%).



Balancing valve

PN 16. Brass construction acc/UNE-EN 12165. Polymer cartridge with EPDM diaphragm. Threaded ends gas (BSP) F - F acc/ISO 228/1. Indicator with graduated scale. Pressure taps connection G1/8" female. Working temperature from - 20°C to 120°C. Appliance with water & water + glycol (50%).

R	A	B	C	D	E
1/2"	83	104	26,6	79	105,6
1/2"	83	104	26,6	79	105,6
1/2"	83	104	26,6	79	105,6
1/2"	83	104	26,6	79	105,6
3/4"	95,1	106	26,6	79	105,6
3/4"	95,1	106	26,6	79	105,6
3/4"	95,1	106	26,6	79	105,6
3/4"	95,1	106	26,6	79	105,6
1"	102	100	26,6	79	105,6
1"	102	100	26,6	79	105,6
1"	102	100	26,6	79	105,6
1"	102	100	26,6	79	105,6

70874 04 10	1/2"	0,495	-	-
70874 04 20	1/2"	0,495	-	-
70874 04 30	1/2"	0,495	-	-
70874 04 40	1/2"	0,495	-	-
70874 05 10	3/4"	0,570	-	-
70874 05 20	3/4"	0,570	-	-
70874 05 30	3/4"	0,570	-	-
70874 05 40	3/4"	0,570	-	-
70874 06 10	1"	0,635	-	-
70874 06 20	1"	0,635	-	-
70874 06 30	1"	0,635	-	-
70874 06 40	1"	0,635	-	-

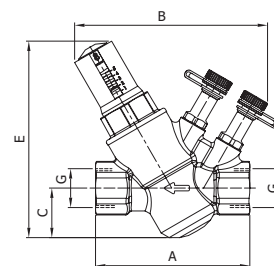

Ref. 78454

NEW

Cartuchos para válvula de equilibrado (art. 70874)

Cartuchos regulables para válvula de equilibrado

Cartridge for balancing valve (art. 70874)

Cartridge for automatic flow control valve



Ref.	Color	Rango caudal / Flow rate (m3/h)
78454 05 00	Negro/ Black	0,100 - 0,412
78454 15 00	Verde / Green	0,157 - 0,609
78454 25 00	Rojo Blanco / Red White	0,275 - 0,825
78454 55 00	Rojo Gris / Red Grey	0,406 - 1,270

78454 05 00	-	0,060	-	-
78454 15 00	-	0,060	-	-
78454 25 00	-	0,060	-	-
78454 55 00	-	0,060	-	-

CÓDIGO CODE	MEDIDA SIZE	PESO WEIGHT	CAJA / BOX CARTON	P.V.P. € PRICE €
----------------	----------------	----------------	----------------------	---------------------

Ref. **72961**

NEW

Llave para regulación de cartuchos válvula de equilibrado (art. 70874)
Permite ajustar el ratio de caudal deseado de los cartuchos regulables en la valvula de equilibrado

72961 00 00	-	0,008	-	-
-------------	---	-------	---	---



Spanner for cartridge adjustment. for balancing valve (art. 70874)
It allows adjusting the flow rate to the desired value by acting on the cartridge of balancing valve

Ref. **70621**

NEW

Tomas de presión para válvula de equilibrado
Toma de presión para roscar a la válvula de equilibrado para realizar la lectura indirecta del flujo de transferencia.

70621 01 50	1/8"	0,060	-	-
-------------	------	-------	---	---



Pressure inlets for balancing valve
Inlet to be set up on threaded balancing valve, used for indirect reading of transfer flow rate.

Ref. **79320**

NEW

Agujas para la medición de presión. Para válvula de equilibrado
Cuerpo adaptador construido en latón. Agujas de acero. Conexión roscada G1/8" hembra ISO 228. Máx. presión de trabajo 16 bar. Máx. temperatura de trabajo 120°C

79320 00 00	1/8"	0,036	-	-
-------------	------	-------	---	---



Needle adapters to measure pressure. For balancing valve
Adapters brass body. Steel needle. G1/8" female threaded end ISO 228. Max. working pressure 16 bar. Max. working temperature 120°C

Ref. **73566**

NEW

Equipo electrónico para medición de la presión diferencial
Equipo electrónico para la medición de la presión diferencial por lectura directa del valor del caudal y la presión en circuitos hidráulicos. Baterías incluidas. Estuche con el kit para la conexión a tomas piezométricas.

73566 00 00	-	-	-	-
-------------	---	---	---	---



Electronic differential pressure measuring device
Electronic differential pressure measuring instrument suitable for the direct reading of flow rate and pressure valve on water circuits. Battery power supply. Complete with case and kits for connection to piezometric sockets.

Ref. 3073



Válvula de equilibrado

PN 20. Construcción cuerpo y componentes internos en latón. Juntas VITON. Extremos rosca gas (BSP) H-H, ISO 228/1. Toma de presión G 1/8" H. Temperatura trabajo de -30°C a 120°C.

Balancing valve

PN 20. Brass construction of body and inner components. Gas threaded ends (BSP) F-F, ISO 228/1. Pressure taps connection G 1/8" F. Working temperature from -30°C to 120°C.

R	A	B	C	D
1/2"	84	15	96	22
3/4"	85,6	17,8	97	21,5
1"	98	21,3	103,3	29,5
1 1/4"	101	28	111	29
1 1/2"	107	31	120	27
2"	115	37	132	21,9

CÓDIGO CODE	MEDIDA SIZE	PESO WEIGHT	CAJA / BOX CARTON	P.V.P. € PRICE €
3073 04	1/2"	0,400	1	-
3073 05	3/4"	0,500	1	-
3073 06	1"	0,700	1	-
3073 07	1 1/4"	1,000	1	-
3073 08	1 1/2"	1,000	1	-
3073 09	2"	1,800	1	-

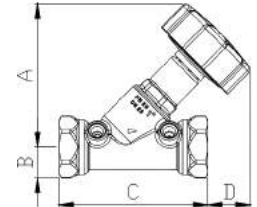

Ref. 2228



Válvula de equilibrado estático – Bridas DIN PN 16

Const. cuerpo y bonete fundición nodular GGG-40. Eje acero inoxidable. Cierre en EPDM. Orificio variable. Doble regulación. Temperatura de trabajo -10°C +120°C.

Static balancing valve – Flanged ends DIN PN 16

Body and bonnet of ductil iron GGG-40. Stainless steel stem. Sealing: EPDM. Variable orifice. Double regulation. Working temperature -10°C +120°C.

MED.	DN	D	L	A	V
2"	50	165	230	276	180
2 1/2"	65	185	290	308	180
3"	80	200	310	320	180
4"	100	220	350	340	180
5"	125	250	400	375	180
6"	150	285	480	410	180
8"	200	340	600	550	350
10"	250	405	730	590	350
12"	300	460	850	678	450

2228 09	2"	11,400	-	-
2228 10	2 1/2"	16,500	-	-
2228 11	3"	19,300	-	-
2228 12	4"	27,000	-	-
2228 13	5"	41,000	-	-
2228 14	6"	55,000	-	-
2228 16	8"	100,000	-	-
2228 18	10"	158,000	-	-
2228 20	12"	213,000	-	-

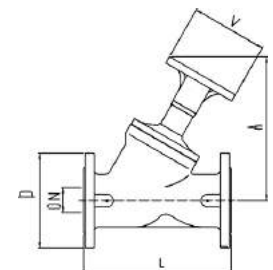

Ref. 73070

NEW

Filtro magnético para calderas "GE-Safe"

Filtro magnético compacto para calderas. Cuerpo de poliamida PA66 + 33%FV. Filtro de 800 micras de acero inoxidable AISI 304. Conexiones M - G3/4" UNE-EN ISO 228. Elemento magnético Neodimio REN35 11.000 Gauss. Máxima presión de trabajo 3 bar. Temperatura máxima de trabajo 90°C

"GE-Safe" magnetic filter for boilers

Compact magnetic filter for boilers. Body construction in polyamide PA66 + 33%FV. Stainless steel filter AISI 304, 800 microns. Connection M - G3/4" UNE-EN ISO 228. Magnetic element Neodymium RE35 11.000 Gauss. Maximum working pressure 3 bar. Maximum working temperature 90°C

R	A	B	C	D
3/4"	185,4	112	64	92,5

73070 05 00	3/4"	0,492	-	-
-------------	------	-------	---	---

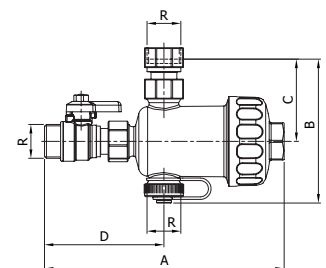

CÓDIGO CODE	MEDIDA SIZE	PESO WEIGHT	CAJA / BOX CARTON	P.V.P. € PRICE €
----------------	----------------	----------------	----------------------	---------------------

Ref. 73286

NEW

Filtro para calderas de condensación "GE-Clean"

Filtro neutralizador para los condensados de calderas de baja potencia (24 - 35 KW). Cuerpo de PA piliamida transparente. Filtro de acero inoxidable AISI 304. Brida de sujeción a pared. Conectores "L" codo G3/4" x DN20. Dos cargas de carbonato calico (Ca CO3).



"GE-Clean" filter for condensing boilers

Acid condensation neutralising filter for low-power boilers (24- 35 KW). Body construction in transparent PA polyamide. Stainless steel filter AISI 304. Wall fixing bracket. "L" elbow connector G3/4" x DN20. Two neutralising loads of calcium carbonate (Ca CO3).

Recambios

Carga de carbonato calico (Ca CO3) - R73286

Spare parts

Neutralising refill of calcium carbonate (Ca CO3) - R73286

R	A	B	C	D
3/4" x 20	160	136	70	59,6

73286 05 00	3/4" x 20	0,196	-	-
-------------	-----------	-------	---	---

R73286 00 00	-	0,118	-	-
--------------	---	-------	---	---

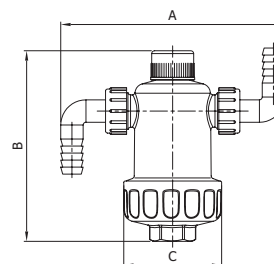

Ref. 4790

Válvula motorizada / zona 2 vías con cable de 2 hilos

Construcción en latón. Extremos rosca gas hembra, ISO 228/1. Aplicación agua fría o caliente. Temperatura fluido <94°C. Temperatura ambiente <40°C. Tensiones 220 V (±10%) 50-60 Hz. Presión nominal 16 bar. Clase de protección IP 40. Palanca para accionamiento manual con muelle de retorno.

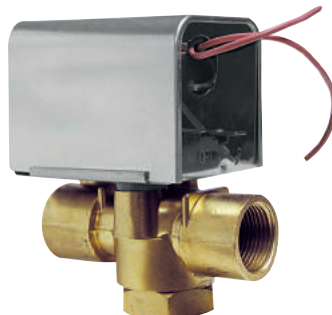

2 ways motorised-zone valve with 2 cores wire

Brass construction. Female threaded ends, ISO 228/1. Aplicacion: cold or hotwater. Fluid temp. <94°C. Environment temp. <40°C. Voltage 220 V (±10%) 50-60 Hz. Nominal pressure 16 bar. IP 40 protection class. Manual operating lever with spring return.

Med.	C	E	F	G	H
4790 04	105,5	84	35,5	63	90
4790 05	105,5	84	35,5	63	93
4790 06	105,5	84	37	63	95

4790 04	1/2"	0,800	1-20	-
4790 05	3/4"	0,826	1-20	-
4790 06	1"	1,009	1-20	-

Recambio: art 4794 Motor para válvula motorizada art. 4790. / Spare parts: art. 4794 Motor for motorised-zone valve art. 4790.

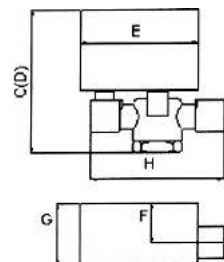

Ref. 4791

Válvula motorizada / zona 3 vías con cable de 2 hilos

Construcción en latón. Extremos rosca gas hembra, ISO 228/1. Aplicación agua fría o caliente. Temperatura fluido <94°C. Temperatura ambiente <40°C. Tensiones 220 V (±10%) 50-60 Hz. Presión nominal 16 bar. Clase de protección IP 40. Palanca para accionamiento manual con muelle de retorno.

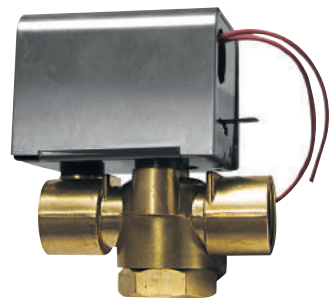

3 ways motorised / zone valve with 2 cores wire

Brass construction. Female threaded ends, ISO 228/1. Aplicacion: cold or hotwater. Fluid temp. <94°C. Environment temp. <40°C. Voltage 220V (±10%) 50-60 Hz. Nominal pressure 16 bar. IP 40 protection class. Manual operating lever with spring return.

Med.	C	E	F	G	H
4790 04	105,5	84	35,5	63	90
4790 05	105,5	84	35,5	63	93
4790 06	105,5	84	37	63	95

4791 04	1/2"	0,835	1-20	-
4791 05	3/4"	0,842	1-20	-
4791 06	1"	1,045	1-20	-

Recambio: art 4794 Motor para válvula motorizada art. 4791. / Spare parts: art. 4794 Motor for motorised-zone valve art. 4791.

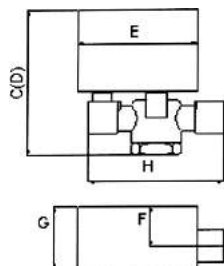

CÓDIGO CODE	MEDIDA SIZE	PESO WEIGHT	CAJA / BOX CARTON	P.V.P. € PRICE €
----------------	----------------	----------------	----------------------	---------------------

Ref. 4792



Válvula motorizada / zona 2 vías ON/OFF con muelle de retorno y con interruptor auxiliar y cable de 5 hilos

Construcción en latón. Extremos rosca gas hembra, ISO 228/1. Aplicación agua fría o caliente. Temperatura fluido <94°C. Temperatura ambiente <40°C. Tensiones 220 V (±10%) 50-60 Hz. Presión nominal 16 bar. Clase de protección IP 40. Palanca para accionamiento manual con muelle de retorno.

2 ways motorised / zone ON/OFF valve with spring return and auxiliary switch and 5 cores wire

Brass construction. Female threaded ends, ISO 228/1. Application: cold or hotwater. Fluid temp. <94°C. Environment temp. <40°C. Voltage 220 V (±10%) 50-60 Hz. Nominal pressure 16 bar. IP 40 protection class. Manual operating lever with spring return.

Med.	C	E	F	G	H
4792 04	105	84	35,5	63	90
4792 05	105,5	84	35,5	63	93
4792 06	109,5	84	37	63	95

4792 04	1/2"	0,902	1-20	-
4792 05	3/4"	0,923	1-20	-
4792 06	1"	1,110	1-20	-

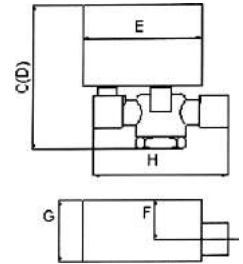

Ref. 4793



Válvula motorizada / zona 3 vías ON/OFF con muelle de retorno y con interruptor auxiliar y cable de 5 hilos

Construcción en latón. Extremos rosca gas hembra, ISO 228/1. Aplicación agua fría o caliente. Temperatura fluido <94°C. Temperatura ambiente <40°C. Tensiones 220 V (±10%) 50-60 Hz. Presión nominal 16 bar. Clase de protección IP 40. Palanca para accionamiento manual con muelle de retorno.

3 ways motorised / zone ON/OFF valve with spring return and auxiliary switch and 5 cores wire

Brass construction. Female threaded ends, ISO 228/1. Application: cold or hotwater. Fluid temp. <94°C. Environment temp. <40°C. Voltage 220 V (±10%) 50-60 Hz. Nominal pressure 16 bar. IP 40 protection class. Manual operating lever with spring return.

Med.	C	E	F	G	H
4793 04	116	84	35,5	63	90
4793 05	119	84	35,5	63	93
4793 06	125	84	37	63	95

4793 04	1/2"	0,985	1-20	-
4793 05	3/4"	0,985	1-20	-
4793 06	1"	1,140	1-20	-

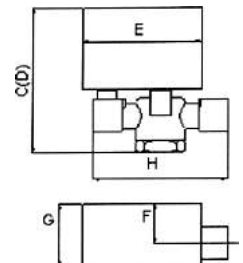

Ref. 3911



Termostato de pared electromecánico

Alimentación: 2 hilos a 250 VAC. IP 20. Diferencial térmico ± 1°C; Rango temperatura regulación: +7 / +30°C; Dimensiones 80x80x44 mm.

Wall electromechanical thermostat

Power supply: 2 wire to 259 VAC. IP 20. Differential ±1°C; Setting temperature range +7 / +30°C; Dimensions 80x80x44 mm.

3911 00	-	75,000	1-20	-
---------	---	--------	------	---

Ref. 3916

NEW



Termostato de pared electrónico

Alimentación: 2 baterías 1,5V, tipo AAA. Rango de contacto 5A, 220VAC. IP20. Rango temperatura regulación: 5-35°C. Diferencial térmico ± 0,5 °C . Resolución 0,1°C. Elemento sensible termistor NTC. Pantalla LCD retro iluminada. No programable

Wall mounted electronic thermostat

Power supply: 2 batteries 1,5V, AAA type. Contact range 5A, 220VAC. IP20. Setting temperature range 5-35°C. Differential ± 0,5 °C . Resolución 0,1°C. Sensing element NTC thermistor. LCD backlight dispaly. Non programmable

3916 00	-	0,138	-	-
---------	---	-------	---	---

CÓDIGO CODE	MEDIDA SIZE	PESO WEIGHT	CAJA / BOX CARTON	P.V.P. € PRICE €
----------------	----------------	----------------	----------------------	---------------------

Ref. 3912

Termostato de pared electrónico

Alimentación: 2 baterías 1,5 V, tipo AAA. Rango temperatura de regulación: 5°C -35°C. Diferencial térmico: ±0,3°C.

3912 00	-	75,000	1	-
---------	---	--------	---	---



Wall mounted electronic thermostat

Power supply: 2 batteries 1,5 V, AAA type. Setting temperature range: 5°C- 35°C. Differential: ±0,3°C.

Ref. 3913

Cronotermostato programable semanal

Alimentación: 2 baterías 1,5V, tipo AA. IP 20. Resolución termómetro 0,1°C. Rango temperatura regulación: 5-35°C. Precisión termómetro ± 0,3°C. Formato horario 12h/24h y selección °C /F.

3913 00	-	0,180	1-14	-
---------	---	-------	------	---

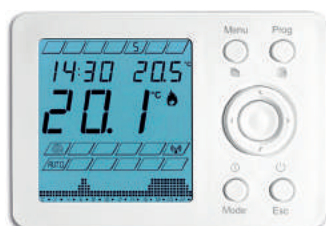

Weekly programmable thermostat

Power supply: 2 batteries 1,5V AA. IP 20. Thermometer resolution 0,1°C. Setting temperature range 5-35°C. Thermometer accuracy ± 0,3°C. 12h/24h clock format and °C /F selection.

Ref. 3914

Termostato de pared digital Touch

Doble modo de funcionamiento (aire acondicionado/calefacción). Rango temperatura invierno: 5°C-30°C. Rango temperatura verano: 15°C a 35°C. Alimentación 2 baterías AAA 1,5 V. Indicador de batería baja. Programa anti-hielo. Conexión eléctrica al dispositivo 220 VCA-5 A. Dimensiones: 115 x 83 x 21 mm.

3914 00	-	0,110	1-14	-
---------	---	-------	------	---



Touch screen wall digital thermostat

Dual mode operation (air conditioning/ heating). Winter temperature range: 5°C-30°C. Summer temperature range: 15°C-35°C. Power supply: 2 batteries 1,5 V, AAA type. Low battery indicator. With defrosting programme. Electrical connection with device 220 VCA-5 A. Dimensions: 115 x 83 x 21 mm.

Ref. 3915

Termostato contacto bimetálico

Termostato contacto bimetálico. Alimentación: a 250 VAC. IP 20. Diferencial térmico 8 ±2 K. Rango temperatura regulación:20/90°C.

3915 00	-	0,110	1-50	-
---------	---	-------	------	---



Bimetallic contact thermostat

Dimensions 112x46x55 mm. Power supply: 250 VAC. IP 20. Temperature diferencial 8 ±2 K; Setting temperature range 20/90°C.

Ref. 8031

Termómetros bimetálicos

Termómetro bimetálico de contacto D. 63, con muelle.

8031 060	-	0,205	1	-
8031 120	-	-	1	-
8031 206	-	0,205	1	-
8031 404	-	0,205	1	-

Bimetallic thermometer

Contact bimetallic thermometer. D. 63, with spring.



Ref. 8045 - 8046



Termómetro de capilla
Salida inferior, vaina latón.
Longitud = 50 mm.

Glass thermometers
Bottom entry, brass sheath.
Length = 50 mm.

Termómetro de capilla
Salida inferior, vaina latón.
Longitud = 100 mm.

Glass thermometers
Bottom entry, brass sheath.
Length = 100 mm.

CÓDIGO CODE	MEDIDA SIZE	PESO WEIGHT	CAJA / BOX CARTON	P.V.P. € PRICE €
8045 404	-	0,167	1	-
8045 060	-	0,167	1	-
8045 120	-	0,167	1	-

8046 404	-	0,2	1	-
8046 060	-	0,2	1	-
8046 120	-	0,2	1	-

Ref. 8047 - 8048



Termómetro de capilla
Salida angular 90°, vaina latón.
Longitud = 50 mm.

Glass thermometers
90° angle entry, brass sheath.
Length = 50 mm.

Termómetro de capilla
Salida angular 90°, vaina latón.
Longitud = 100 mm.

Glass thermometers
90° angle entry, brass sheath.
Length = 100 mm.

8047 404	-	0,17	1	-
8047 060	-	0,17	1	-
8047 120	-	0,17	1	-

8048 404	-	0,202	1	-
8048 060	-	0,202	1	-
8048 120	-	0,202	1	-

Ref. 3900



Termostato electrónico oscilante/modular con pantalla LCD (empotrar)

Alimentación: 24 VAC. Consumo: 5 VA (sin carga). Precisión: $\pm 0,5^{\circ}\text{C}$. Rango de control: 10°C-30°C. Temperatura de trabajo: 0-55°C. Humedad ambiente máxima: 90%HR. Dimensiones: 93 x 113 x 27 mm.

Electronic floating/modulating thermostat with LCD display (built-in)

Power supply: 24 VAC. Consumption: 5 VA (without load). Precision: $\pm 0,5^{\circ}\text{C}$. Control range: 10°C-30°C. Working temperature: 0-55°C. Maximum environment humidity: 90% RH. Dimensions: 93 x 113 x 27 mm.

3900 00	-	0,151	1-50	-
---------	---	-------	------	---

Ref. 3901



Termostato electrónico ON/OFF con display fondo color (de empotrar)

Alimentación: 220-230 VAC. Consumo: 6 VA (sin carga). Precisión: $\pm 0,5^{\circ}\text{C}$. Rango control: 10°C-30°C. Temperatura de trabajo: 0-55°C. Humedad ambiente máxima: 90% HR. Dimensiones: 86 x 86 x 33 mm.

Electronic ON/OFF thermostat with colour back light display (built-in)

Power supply: 220-230 VAC. Consumption: 6 VA (without load). Precision: $\pm 0,5^{\circ}\text{C}$. Control range: 10°C-30°C. Working temperature: 0-55°C. Maximum environment humidity: 90% RH. Dimensions: 86 x 86 x 33 mm.

3901 00	-	0,105	1-50	-
---------	---	-------	------	---

CÓDIGO CODE	MEDIDA SIZE	PESO WEIGHT	CAJA / BOX CARTON	P.V.P. € PRICE €
----------------	----------------	----------------	----------------------	---------------------

Ref. **3905**



Termostato electrónico oscilante/modular con selector (de empotrar)

Alimentación: 24 VAC. Consumo: 2 VA (sin carga). Precisión: ±1°C. Rango control: 10°C-30°C. Temperatura de trabajo: 0-55°C. Máxima humedad ambiente: 90%. Dimensiones: 87 x 132 x 41 mm.

Electronic floating/modulating thermostat with switching system (built-in)

Power supply: 24VAC. Consumption: 2 VA (without load). Precision: ±1°C. Control range: 10°C-30°C. Working temperature: 0-55°C. Maximum environment humidity: 90%. Dimensions: 87 x 132 x 41 mm.

3905 00	-	0,165	1-50	-
---------	---	-------	------	---

Ref. **3906**



Termostato electrónico oscilante/modular con pantalla LCD (de empotrar)

Alimentación: 24 VAC. Consumo: 5 VA (sin carga). Precisión: ±0,5°C. Rango control: 10°C-30°C. Temperatura de trabajo: 0-55°C. Máxima humedad ambiente: 90%. Dimensiones: 93 x 113 x 26 mm.

Electronic floating/modulating thermostat with LCD display (built-in)

Power supply: 24 VAC. Consumption: 5 VA (without load). Precision: ±0,5°C. Control range: 10°C-30°C. Working temperature: 0-55°C. Maximum environment humidity: 90%. Dimensions: 93 x 113 x 26 mm.

3906 00	-	0,144	1-50	-
---------	---	-------	------	---

Ref. **73262**

NEW

Bomba descarga condensados

Unidad de pared para evacuar los condensados generados por unidades de climatización de hasta 13 KW. Caudal máximo 10 L/h. Temperatura máxima agua drenaje 40°C. Tensión de alimentación 230V AC 50-60Hz 16W. Homologación CE

Condensate removal pump

Wall pump unit for condensate removal in air conditioning up to 13 KW. Maximum flow rate 10 L/h. Max. discharge water temperature 40°C. Electrical power 230V AC 50-60Hz. CE marked.



73262 00 00	10 L	0,450	-	-
-------------	------	-------	---	---

Ref. **3255**

Bomba de condensación

Sistema compuesto de una unidad de bomba y de una unidad de detección para evacuar los condensados en unidades de aire acondicionado y de refrigeración. Voltaje 230 V 50/60 Hz. Instalación externa. Caudales 12 L/h. Temp. ambiente 0°C +50°C.

Condensate pump

It is a system which consists of a pump unit and detection unit allowing condensates to be evacuated in air conditioning and refrigeration. External Installation. Voltage 230 V 50/60 Hz. Flow rate 12 L/h. Ambient temp: 0°C +50°C.



3255 12L	12 L	0,705	1-1	-
----------	------	-------	-----	---

CÓDIGO CODE	MEDIDA SIZE	PESO WEIGHT	CAJA / BOX CARTON	P.V.P. € PRICE €
----------------	----------------	----------------	----------------------	---------------------

Ref. 3256



Bomba de condensación mini

Sistema compuesto de una unidad de bomba y de una unidad de detección para evacuar los condensados en unidades de aire acondicionado y de refrigeración. Voltaje 230 V 50/60 Hz. Instalación interna. Caudales 12 L/h o 36 L/h. Temp. ambiente 0°C +50°C.

Mini condensate pump

It is a system which consists of a pump unit and detection unit allowing condensates to be evacuated in air conditioning and refrigeration. Internal installation. Voltage 230 V 50/60 Hz. Flow rate 12 L/h or 36 L/h. Ambient temp.: 0°C +50°C.

3256 12L	12 L	0,634	1-1	-
3256 36L	36 L	0,634	1-1	-

Ref. 3262



Bomba de condensación mini

Sistema compuesto de una unidad de bomba y una unidad de detección para evacuar los condensados en unidades de aire acondicionado y de refrigeración. Voltaje 230V 50/60 Hz. Instalación interna o externa. Caudal entre 4 y 7 L/h. Máxima temperatura del condensado 40°C.

Mini Condensate pump

It is a system which consists of a pump unit and detection unit allowing condensates to be evacuated in air conditioning and refrigeration. Voltage 230V 50/60 Hz. Internal or external installation. Flow rate between 4 and 7 L/h. Máx. Temperature of condensate 40°C.

3262 00	-	0,25	1-24	-
---------	---	------	------	---

Ref. 3263



Bomba de condensación

Sistema compuesto de una unidad de bomba y una unidad de detección para evacuar los condensados en calderas, unidades de aire acondicionado y de refrigeración. Voltaje 230V 50 Hz. Instalación externa. Caudal máximo 370 L/h. Máxima temperatura del condensado 50°C.

Condensate pump

It is a system which consists of a pump unit and detection unit allowing condensates to be evacuated in boiler, air conditioning and refrigeration. Voltage 230V 50 Hz. Internal or external installation. Flow rate max.370 L/h. Máx. Temperature of condensate 50°C.

3263 00	-	2,3	1-4	-
---------	---	-----	-----	---

Ref. 70500



Mando universal aire acondicionado

A/C universal remote control

70500	-	0,111	1-100	-
-------	---	-------	-------	---

CALEFACCIÓN Y ENERGÍA SOLAR HEATING & SOLAR ENERGY

ENERGÍA SOLAR TÉRMICA THERMAL SOLAR ENERGY

La “energía solar térmica” es una tecnología que convierte la luz solar en calor que puede después ser usado para calentar agua para uso doméstico y para el sistema de calefacción.

Existen diferentes tipos de sistemas solares empleados para el calentamiento de agua sanitaria y/o la propia calefacción, entre los cuales destacan por ser los más utilizados los sistemas de circulación natural, los sistemas de circulación forzada y los sistemas combinados.

Para todos los tipos existentes se requiere de una serie de elementos para su instalación, de los cuales Genebre pone a su disposición una amplia gama de ellos, que se irá ampliando según las necesidades de nuestros clientes e instaladores.

“Thermal solar energy” is a technology that converts sunlight into heat that can then be used to heat domestic water and heating system.

There are different types of solar systems used only for the heating of water for human consumption and/or for the heating system, forced circulation systems and combined systems being among those which stand out as being the most widely used natural circulation systems.

For all existing types a series of elements are required for their installation. Genebre offers a wide range of them, to be expanded according to the needs of our customers and installers.

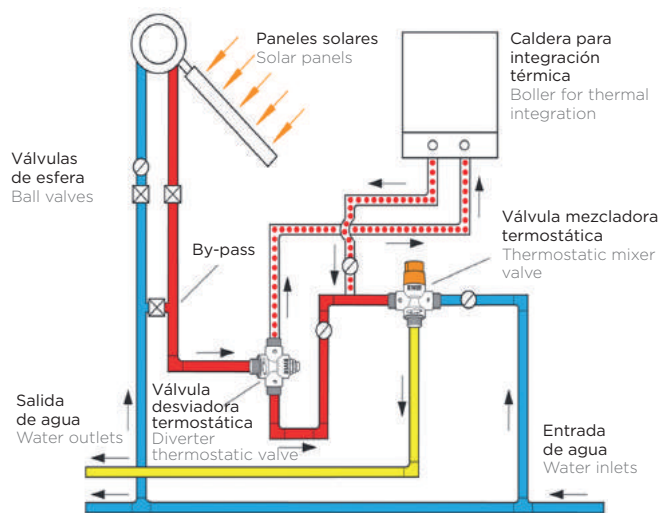
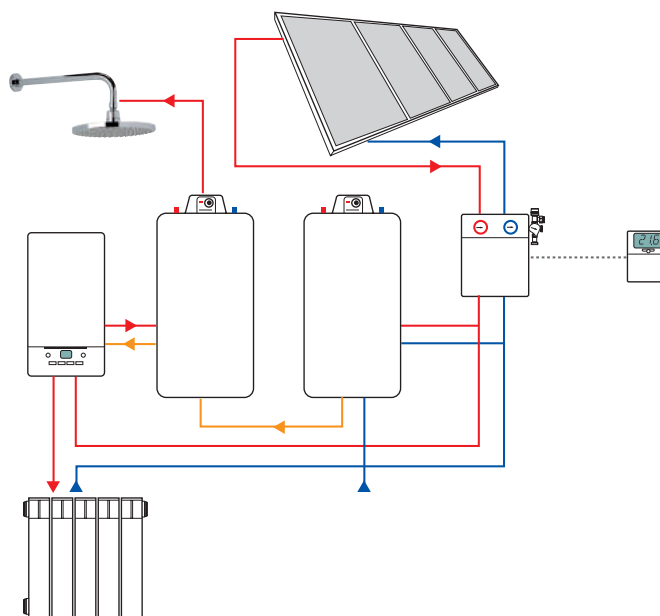

Instalación básica
Basic installation

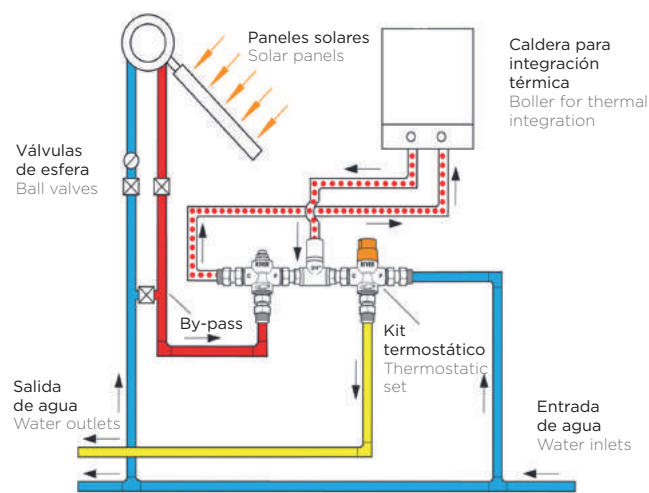

Esquema kit termostático
Thermostatic kit installation

Ref. 3134



Válvula de esfera

PN 25. Paso total. Construcción en latón UNE-EN 12165 cromado. Juntas PTFE. Extremos rosca gas M-H, ISO 228/1. Temp. máx. 150°C. Mando manual por palanca acero.

Ball valve

PN 25. Full bore. Body chrome plated brass UNE-EN 12165. Seats PTFE. Gas threaded ends M-F, ISO 228/1. Max. temp. 150°C. Manual control lever steel handle.

R	P	A	L	M
1/2"	15	47	55	84
3/4"	20	58	64	98
1"	25	61	76	98
1 1/4"	32	74	87	126
1 1/2"	40	80	95	126
2"	50	91	109	158

CÓDIGO CODE	MEDIDA SIZE	PESO WEIGHT	CAJA / BOX CARTON	P.V.P. € PRICE €
3134 04	1/2"	0,170	8-192	-
3134 05	3/4"	0,275	6-108	-
3134 06	1"	0,410	6-72	-
3134 07	1 1/4"	0,650	4-48	-
3134 08	1 1/2"	0,875	2-24	-
3134 09	2"	1,370	2-18	-

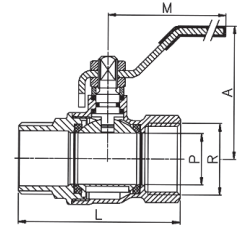

Ref. 3136



Válvula de esfera

PN 25. Paso total. Construcción en latón UNE-EN 12165 cromado. Juntas PTFE. Extremos rosca gas M-H, ISO 228/1. Temp. máx. 150°C. Mando manual por palomilla aluminio.

Ball valve

PN 25. Full bore. Body chrome plated brass UNE-EN 12165. Seats PTFE. Gas threaded ends M-F, ISO 228/1. Max. temp. 150°C. Manual control lever aluminium handle.

R	P	A	L	M
3/8"	10	38	49	50
1/2"	15	40	56	50
3/4"	20	50	64	62
1"	25	53	76	62

CÓDIGO CODE	MEDIDA SIZE	PESO WEIGHT	CAJA / BOX CARTON	P.V.P. € PRICE €
3136 03	3/8"	0,105	12-288	-
3136 04	1/2"	0,150	10-240	-
3136 05	3/4"	0,250	6-108	-
3136 06	1"	0,380	5-90	-

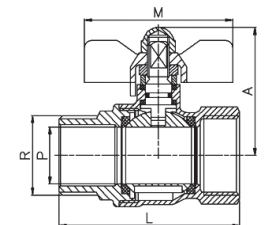

Ref. 70037



Purgador automático de aire

Cuerpo en latón niquelado. Extremo rosca macho ISO 228/1. Temperatura máxima de trabajo 160°C. Presión máxima de trabajo: 10 bar.

Automatic air vent

Body brass nickel-plated. Male thread ISO 228/1. Maximum working temperature 160°C. Maximum working pressure: 10 bar.

R	A	D	H
G 3/8"	79	50	64

CÓDIGO CODE	MEDIDA SIZE	PESO WEIGHT	CAJA / BOX CARTON	P.V.P. € PRICE €
70037 03 00	3/8"	0,224	10-80	-

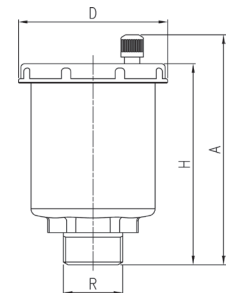

Ref. 3178



Válvula de seguridad escuadra

Cuerpo en latón. Extremos rosca hembra ISO 228/1. Temperatura máxima de trabajo 160°C. Taraje 6 bar.

Safety angle valve

Body in brass. Female threaded ends ISO 228/1. Maximum working temperature 160°C. 6 bar setting pressure.

H	A
76	31

CÓDIGO CODE	MEDIDA SIZE	PESO WEIGHT	CAJA / BOX CARTON	P.V.P. € PRICE €
3178 04	1/2" x 3/4"	0,116	10-100	-



CÓDIGO MEDIDA PESO CAJA / BOX P.V.P. €
CODE SIZE WEIGHT CARTON PRICE €

Ref. 3144

Válvula de descarga para caldera

PN 25. Paso total. Construcción en latón UNE-EN 12165 cromado. Asientos PTFE. Extremos rosca gas (BSP) M ISO 228/1 y conexión a manguera Ø 15 con tapón seguridad. Temp. máx. 150°C. Mando manual por palomilla aluminio.

Boiler discharge valve

PN 25. Full bore. Body brass UNE-EN 12165. PTFE seats. Threaded end male ISO 228/1 and Ø15 hose connection with safety cap. Max. temp. 150°C. Aluminium butterfly handle.



R	DN	H	L	M
G 1/2" x Ø 15	10	34	72	35,5

3144 04	1/2" x Ø 15	0,145	8-192	-
---------	-------------	-------	-------	---

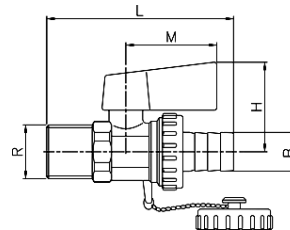

Ref. 2444

Válvula retención "Small" - "Idrja" para solar

Construcción: AISI 304 - asiento vitón. Extremos roscados DIN 2999. Temp. de trabajo, mín. -25°C máx. +150°C. Presión de trabajo, 16 bar. Presión de apertura, 0,03 bar.

"Small" check valve "Idrja" for solar energy

Constr.: AISI 304 - viton seat. Gas threaded ends DIN 2999. Working temp. min. -25°C +150°C. Working pressure: 16 bar. Opening pressure: 0.03 bar.



DN	R	B	C
15	1/2"	32	55
20	3/4"	44	66,7
25	1"	53	83
32	1 1/4"	62	97

2444 04	1/2"	0,500	12-288	-
2444 05	3/4"	0,400	8-104	-
2444 06	1"	0,600	8-80	-
2444 07	1 1/4"	0,001	6-48	-

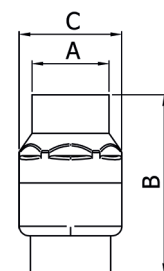

Ref. 1431S

Mezclador termostático vertical para paneles solares

Volante de regulación de temperatura de 30°C a 65°C. Temperatura máxima de entrada de agua 100°C. Aplicación para paneles solares.

Vertical thermostatic mixing valve for solar installation

Temperature adjusting handle from 30°C to 65°C. Maximum temperature inlet 100°C. For solar panels application.



R	A	B	C	ØD
3/4"	58	93	42	36,5

1431S 05	3/4"	0,375	1-48	-
----------	------	-------	------	---

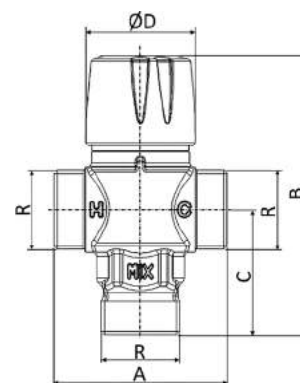

Ref. 1431U

Mezclador termostático vertical universal

Dispositivo para regular temperatura con bloqueo del suministro según EN 1111. Cartucho extraíble y unidad termostática especial con protección anticál y alta velocidad de respuesta. Posibilidad de bloqueo del volante tras la regulación. Temperatura máxima de entrada agua 110°C y posibilidad de regulación de 25°C a 65°C. Aplicación en todos los sistemas sanitarios.

Universal vertical thermostatic mixing valve

Anti-scalding device with stop water supply EN 1111. Extractable cartridge and thermostatic special unit with lime protection and high-speed response. Possibility to block the handle position after the adjusting of the temperature. Maximum temperature inlet 110°C and possibility of adjustment from 25°C to 65°C. For all of the sanitary systems application.



a	b
63	42

1431U	3/4"	0,396	1	-
-------	------	-------	---	---

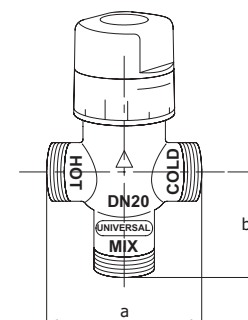

Ref. 1444



Mezclador termostático vertical con termómetro

Dispositivo para regular temperatura con bloqueo del suministro según EN 1111. Cartucho extraíble y unidad termostática especial con protección antical y alta velocidad de respuesta. Posibilidad de bloqueo del volante tras la regulación. Temperatura máxima de entrada agua 110°C. Termómetro de inmersión incorporado. Con filtro de acero inoxidable, válvula de retención y rácores incorporados. Aplicación para paneles solares.

Vertical thermostatic mixing valve with thermometer

Anti-scalding device with stop water supply S/EN 1111. Extractable cartridge and thermostatic special unit with lime protection and high-speed response. Possibility to block the handle position after the adjusting of the temperature. Maximum temperature inlet 110°C. Immersion thermometer incorporated. With stainless steel filter, check valve and tangs incorporated. For solar panels application.

Medida/ Size	a	b
3/4"	165	120
1/2"	147	120

CÓDIGO CODE	MEDIDA SIZE	PESO WEIGHT	CAJA / BOX CARTON	P.V.P. € PRICE €
1444 04	1/2"	1,070	1	-
1444 05	3/4"	1,175	1	-

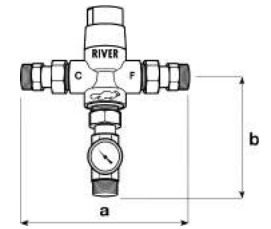

Ref. 1452



Válvula desviadora termostática

Desvía automáticamente el agua caliente que proviene del panel a la caldera, sólo cuando es necesario integrar la temperatura. Elemento termostático con protección antical y alta velocidad de respuesta. Temperatura máxima de entrada agua 110°C. Válvula tarada a 40°C.

Divert thermostatic valve

Divert automatically the hot water coming from the panel to the boiler only when it is necessary integrate the temperature. Thermostatic unit with lime protection and high-speed response. Maximum temperature inlet 110°C. Setting temperature 40°C.

a	b
90	44

1452 05	3/4"	0,645	1	-
---------	------	-------	---	---

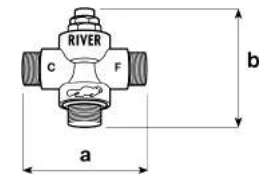

Ref. 1451

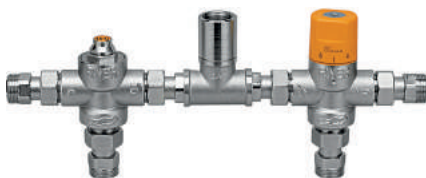

Kit termostático con válvula desviadora y mezclador

Kit termostático premontado antiescaldo para facilitar la conexión desde el panel solar hasta la caldera y una válvula desviadora termostática. Mezclador con temperatura máxima de entrada 110°C, filtro de inoxidable, válvula de retención y rácores. Válvula desviadora termostática con temperatura preestablecida de 40°C.

Thermostatic kit with divert valve and mixer

Anti-scalding connected thermostatic kit for facilitate connection from the solar panel to the boiler. Mainly composed of a vertical thermostatic mixer and a divert thermostatic valve. Mixer with stainless steel filter, check valve and tangs with maximum water inlet temperature 110°C. Divert thermostatic valve with setting temperature 40°C.

a	b	c
198	360	180

1451 05	3/4"	2,275	1	-
---------	------	-------	---	---

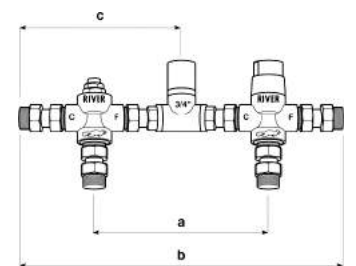

CÓDIGO MEDIDA PESO CAJA / BOX P.V.P. €
CODE SIZE WEIGHT CARTON PRICE €

Ref. **0550**



Racor acoplamiento

Construcción en latón. Acoplamiento para conexión tubo corrugado.

Coupling fitting

Brass construction. Corrugated pipe coupling connection.

0550 16	DN16	0,215	10-150	-
0550 20	DN20	0,290	6-90	-
0550 25	DN25	0,400	4	-

Ref. **0565**



Racor conexión rosca macho

Construcción en latón. Acoplamiento para conexión tubo corrugado. Extremo rosca macho.

Male thread connection fitting

Brass construction. Corrugated pipe coupling connection. Male thread connection.

0565 16 05	DN16 x 3/4"	0,150	10-180	-
0565 20 05	DN20 x 3/4"	0,200	6-120	-
0565 20 06	DN20 x 1"	0,220	1	-

Ref. **0570**



Racor conexión rosca hembra

Construcción en latón. Acoplamiento para conexión tubo corrugado. Extremo rosca hembra.

Female thread connection fitting

Brass construction. Corrugated pipe coupling connection. Female thread connection.

0570 16 05	DN16 x 3/4"	0,140	10-180	-
0570 20 05	DN20 x 3/4"	0,160	6-150	-
0570 20 06	DN20 x 1"	0,195	1	-

Ref. **0580**



Tubo corrugado flexible

Construcción en acero inoxidable. Rollo 25 m.

Corrugated flexible pipe

Stainless steel construction. 25 m. coil

0580 16	-	4,912	-	-
0580 20	-	6,325	-	-

Precios a consultar / Prices on request



2018

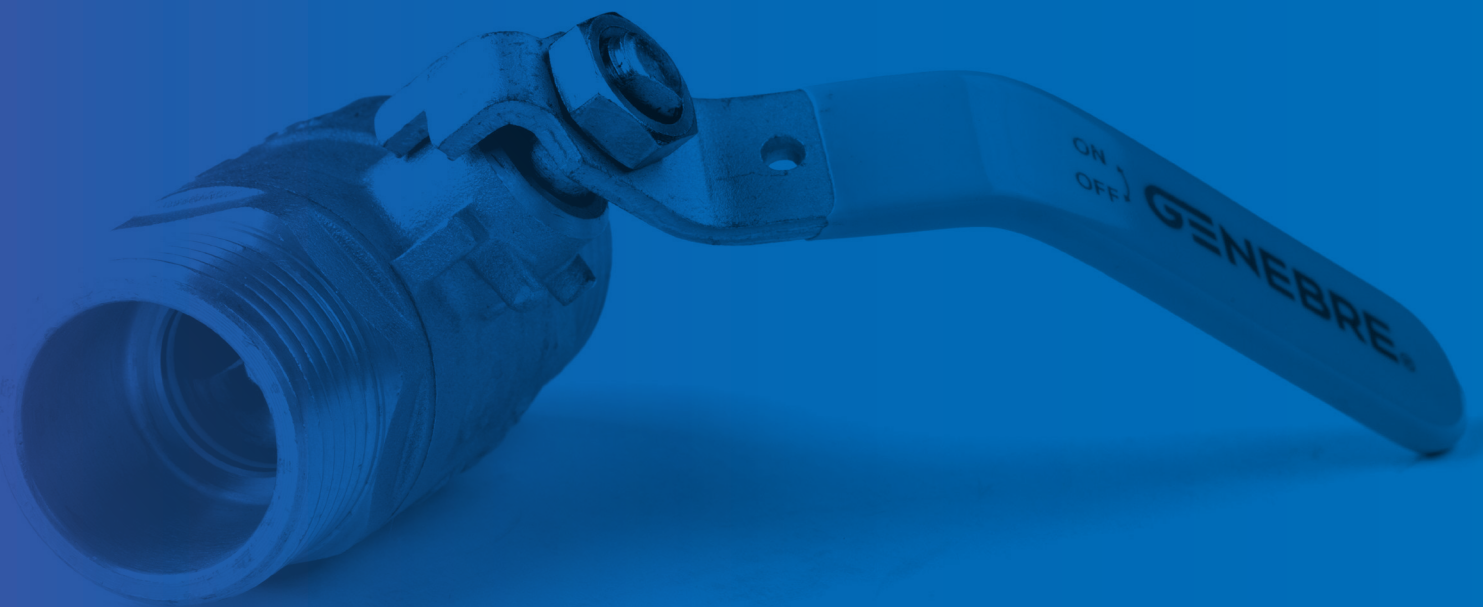



VÁLVULAS DE GAS

GAS VALVES

Válvulas de gas con certificación AENOR para el mercado español, diseñadas según normas UNE-EN 331 y UNE 60718. Y otras válvulas de gas para mercados internacionales.

Gas valves with AENOR certification for the Spanish market, designed according to UNE-EN 331 and UNE 60718 standards, as well as other gas valves for the International markets.

VÁLVULAS DE GAS GAS VALVES

Las válvulas de gas de Genebre están diseñadas según normas UNE- EN 331 y UNE 60718.

Estas válvulas están destinadas a instalaciones domésticas y comerciales que no se encuentran enterradas directamente en el interior o exterior de edificios, y que emplean gases de la primera, segunda y tercera familia, según la norma en 437.

Genebre's gas valves are designed according to UNE-EN 331 and UNE 60718 standards.

They are used for domestic and commercial installations not buried deep inside or outside of buildings, and which use first, second and third family gases, according to en 437 standards.

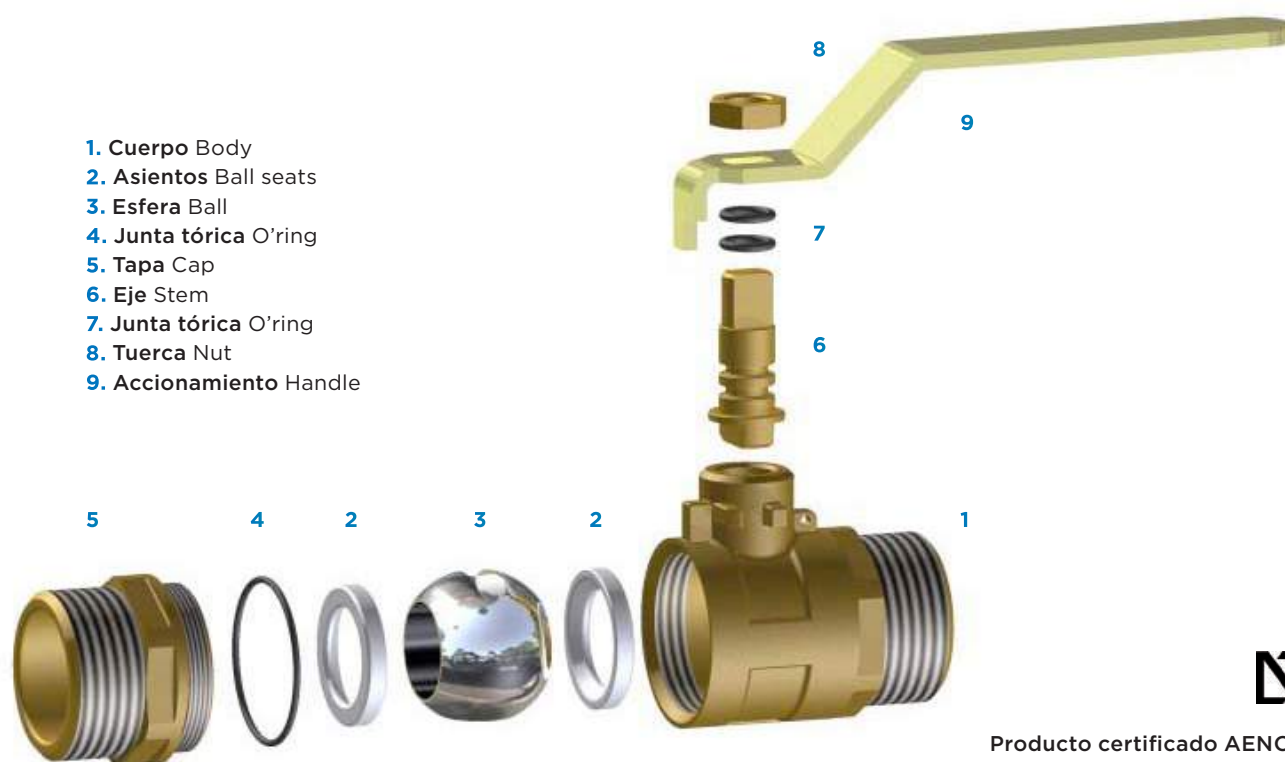

Producto certificado AENOR
AENOR certificated product

CARACTERÍSTICAS DE LAS VÁLVULAS

- Construcción en latón UNE-EN 12164-12165
- Juntas en NBR según EN 549
- Extremos roscados gas (BSP) según ISO 228/1
- Eje con doble junta tórica
- Accionamientos precintables
- Sellado de cuerpo y tapa mediante adhesivo y junta tórica
- Temperatura de servicio desde -40°C a 60°C
- Sistema de bloqueo en posición de cierre
- Presión de trabajo 5 bar (MOP 5)
- Garantizada para el uso de Gas Natural

VALVES CHARACTERISTICS

- Brass construction UNE-EN 12164-12165
- NBR joint following EN 549
- Gas (BSP) threaded ends according ISO 228/1
- Stem with double o'ring
- Sealeable handles
- Body and cap sealed by means adhesive and o-ring
- Service temperature from -40°C to 60°C
- Locking system at closed position
- Working pressure 5 bar (MOP 5)
- Guaranteed for the use of Natural Gas

Ref. 3610



Válvula recta para gas, M-M
Mando palanca de acero con recubrimiento DACROMET precintable.

Straight valve for gas, M-M
Sealable DACROMET covering steel lever handle.

R	P	L	A	M	t
1/2"	10	56	46	84	10
3/4"	15	65	48	84	13
1"	20	75	58	98	15
1 1/4"	25	87	62	98	19
1 1/2"	32	101	74	125	21
2"	40	124	80	125	27

CÓDIGO CODE	MEDIDA SIZE	PESO WEIGHT	CAJA / BOX CARTON	P.V.P. € PRICE €
-------------	-------------	-------------	-------------------	------------------

3610 04	1/2"	0,164	8-144	-
3610 05	3/4"	0,220	8-144	-
3610 06	1"	0,365	6-72	-
3610 07	1 1/4"	0,575	4-48	-
3610 08	1 1/2"	0,825	2-24	-
3610 09	2"	1,380	2-24	-

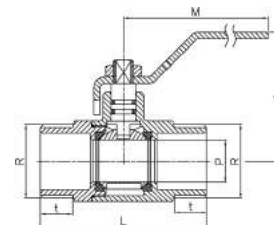

Ref. 3615



Válvula recta para gas, M-M
Mando palomilla de aluminio precintable.

Straight valve for gas, M-M
Sealable aluminium butterfly handle.

R	P	L	A	M	t
1/2"	10	56	35	50	10
3/4"	15	65	37	50	13
1"	20	75	45	62	15
1 1/4"	25	87	49	62	19

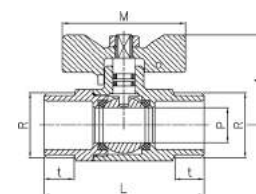

Ref. 3620



Válvula recta para gas, M-H tuerca deslizante
Mando palanca de acero con recubrimiento DACROMET precintable.

Straight valve for gas, M-F sliding nut
Sealable DACROMET covering steel lever handle.

R	P	L	A	M	t
3/4"	15	70	48	84	13
7/8"	20	75	58	98	15
1 1/4"	25	100	62	98	19

3620 05	3/4"	0,255	6-108	-
3620 78	7/8"	0,405	6-72	-
3620 07	1 1/4"	0,670	2-24	-

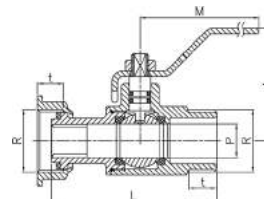

Ref. 3622



Válvula recta para gas, M-H tuerca deslizante
Mando palomilla de aluminio precintable.

Straight valve for gas, M-F sliding nut
Sealable aluminium butterfly handle.

R	P	L	A	M	t
3/4"	15	70	37	50	13
7/8"	20	75	45	62	15
1 1/4"	25	100	49	62	19

3622 05	3/4"	0,235	5-90	-
3622 78	7/8"	0,385	5-90	-
3622 07	1 1/4"	0,650	4-48	-

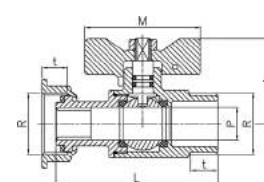

Ref. 3625



Válvula escuadra para gas, M-H tuerca deslizante
Mando palanca de acero con recubrimiento DACROMET precintable.

Angle valve for gas, M-F sliding nut
Sealable DACROMET covering steel lever handle.

R	P	L	A	M	t
3/4"	15	38	48	84	12
7/8"	20	39	58	98	12
1 1/4"	25	59	62	98	16

3625 05	3/4"	0,235	6-108	-
3625 78	7/8"	0,375	6-72	-
3625 07	1 1/4"	0,640	2-48	-

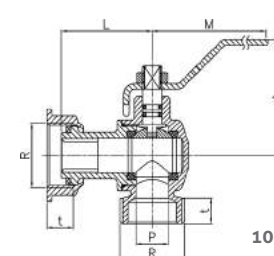

CÓDIGO MEDIDA PESO CAJA / BOX P.V.P. €
CODE SIZE WEIGHT CARTON PRICE €

Ref. 3627

Válvula escuadra para gas, M-H tuerca deslizante
Mando palomilla de aluminio precintable.

Angle valve for gas, M-F sliding nut
Sealable aluminium butterfly handle.



R	P	L	A	M	t
3/4"	15	70	37	50	13
7/8"	20	75	45	62	15
1 1/4"	25	100	49	62	19

3627 05	3/4"	225,000	5-90	-
3627 78	7/8"	0,355	5-90	-
3627 07	1 1/4"	0,620	4-48	-

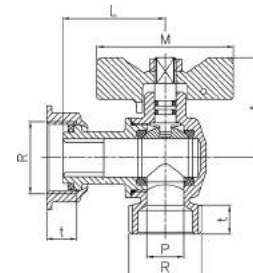

Ref. 3630

Válvula recta para gas, M-M con patas
Mando palanca de acero con recubrimiento DACROMET precintable.

Straight valve for gas, M-M with feet
Sealable DACROMET covering steel lever handle.



R	P	L	A	M	t
1/2"	10	56	46	84	10
3/4"	15	65	48	84	13

3630 04	1/2"	0,188	8-144	-
3630 05	3/4"	0,258	8-96	-

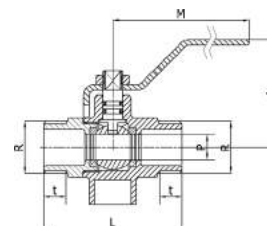

Ref. 3632

Válvula recta para gas, M-M con patas
Mando palomilla de aluminio precintable.

Straight valve for gas, M-M with feet
Sealable aluminium butterfly handle.



R	P	L	A	M	t
1/2"	10	56	35	50	10
3/4"	15	65	37	50	13

3632 04	1/2"	0,171	10-180	-
3632 05	3/4"	0,236	6-108	-

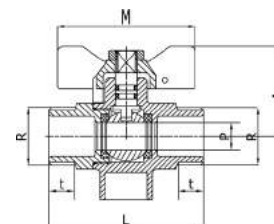

Ref. 3640

Válvula recta para gas con patas y conexión a tubo de PE
Mando palomilla de aluminio precintable.

Straight valve for gas with feet and PE tube connection
Sealable aluminium butterfly handle



R	r	P	A	B	L	M	t
G3/4"	Rp 1/4"	15	42	20	104	48	13
G3/4"	Rp 1/4"	15	42	32	111	48	13

3640 05 20	G 3/4" x PE20	0,450	1-36	-
3640 05 32	G3/4" x PE32	0,630	1-36	-

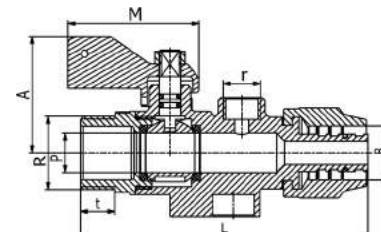

Ref. 3600



Válvula para gas con autobloqueo, M-M
Mando precintable en zamak. Accionamiento con muelle de seguridad. Acabado superficial cromado.

Gas valve with autolock, M-M
Zamak sealable handle. Manual control with safety spring. Chrome-plated surface finishing.

R	P	L	A	M
1/2"	9	55	32	51
M20 x 1,5	9	55	32	51
3/4"	14	65	38	51

CÓDIGO CODE	MEDIDA SIZE	PESO WEIGHT	CAJA / BOX CARTON	P.V.P. € PRICE €
3600 04	1/2"	0,162	1-192	-
3600 20	M20 x 1,5	0,162	1-192	-
3600 05	3/4"	0,234	1-100	-

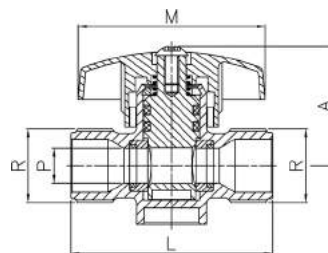

Ref. 3692

NEW



Válvula recta para gas M-M con autobloqueo y limitador de caudal
Mando precintable en zamak. Accionamiento con muelle de seguridad. Acabado superficial cromado.

Straight gas valve M-M with autolock and flow limiter
Zamak sealable handle. Manual control with safety spring. Chrome-plated surface finishing

R	P	L	A	M
1/2"	9	57	34,5	46

3692 04	1/2"	0,190	-	-
---------	------	-------	---	---

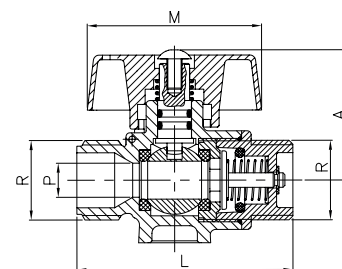

Ref. 3691

Válvula limitadora de caudal externo M-H
Interrompe el caudal por demanda excesiva. Construcción en latón según UNE-EN 12165
Acabado superficial cromado

External flow limiter valve M-F
Interrupts the flow due to excessive demand. Construction in brass acc/ UNE-EN 12165
Chrome-plated surface finishing



3691 04	1/2"	0,052	-	-
---------	------	-------	---	---

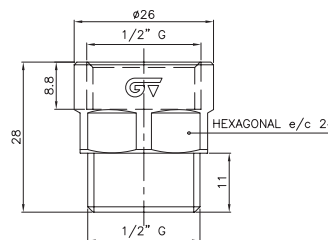

Ref. 3690

NEW



Puente de prueba para contador de gas tipo G4
Construcción racor en latón s/UNE-EN 12165. Tubo de cobre. Extremos rosca macho gas (BSP) s/ISO 228/1. Soldadura Estaño-Plata. Garantizada para el uso de Gas Natural. Temperatura máxima de trabajo 60°C.

Gas bridge for G4 meters
Fitting brass according to UNE-EN 12165. Tube in cooper material. Thread end gas (BSP) male according to ISO 228/1. Silver-Tin welding. Guaranteed for the use og Natural Gas. Max. working temperature 60°C.

R	L	D
7/8"	160	10

3690 78	7/8"	0,168	-	-
---------	------	-------	---	---

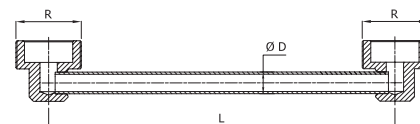

CÓDIGO CODE	MEDIDA SIZE	PESO WEIGHT	CAJA / BOX CARTON	P.V.P. € PRICE €
----------------	----------------	----------------	----------------------	---------------------

Ref. **3650**

NEW

Conjunto flexible inoxidable con valvula de seguridad DN 12 para aparatos de gas

Tubo flexible de acero inoxidable AISI 316L. Malla trenzada con hilo de inoxidable AISI 304. Cobertura plastica de PVC retráctil, según UNE-EN 14800. Enchufe rapido de seguridad según UNE-EN 15069. Conexión Macho-Macho, R1/2" x R1/2" ISO 7/1 (UNE-EN 10266). Presión maxima de utilización 0,5 bar. Longitud disponible 1m.

DN 12 stainless steel flexible connection with safety valve for gas appliances

Stainless steel flexible hose AISI 316L. Wide braid in stainless steel AISI 304. Protective sheat in retractible PVC, according to UNE-EN 14800. Safety valve according to UNE-EN 15069. Male-Male connection, R1/2" x R1/2" ISO 7/1 (UNE-EN 10266). Maximum working pressure 0,5 bar. Length available 1m.

3650 04 100	1/2"	-	-	-
-------------	------	---	---	---



Ref. **3651**

NEW

Conjunto flexible inoxidable con valvula de seguridad DN 12 para aparatos de gas

Tubo flexible de acero inoxidable AISI 316L. Malla trenzada con hilo de inoxidable AISI 304. Cobertura plastica de PVC retráctil, según UNE-EN 14800. Enchufe rapido de seguridad según UNE-EN 15069. Conexión Macho-Hembra, R1/2" x Rp1/2" ISO 7/1 (UNE-EN 10266). Presión maxima de utilización 0,5 bar. Longitud disponible 1m.

DN 12 stainless steel flexible connection with safety valve for gas appliances

Stainless steel flexible hose AISI 316L. Wide braid in stainless steel AISI 304. Protective sheat in retractible PVC, according to UNE-EN 14800. Safety valve according to UNE-EN 15069. Male-Female connection, R1/2" x Rp1/2" ISO 7/1 (UNE-EN 10266). Maximum working pressure 0,5 bar. Length available 1m.

3651 04 100	1/2"	-	-	-
-------------	------	---	---	---



Ref. **3652**

NEW

Conjunto flexible inoxidable DN 12 para aparatos de gas

Tubo flexible de acero inoxidable AISI 316L. Malla trenzada con hilo de inoxidable AISI 304. Cobertura plastica de PVC retráctil, según UNE-EN 14800. Conexión tuerca loca Hembra-Hembra, Rp1/2" x Rp1/2" ISO 7/1 (UNE-EN 10266). Presión maxima de utilización 0,5 bar. Longitud disponible 1m.

DN 12 stainless steel flexible connection for gas appliances

Stainless steel flexible hose AISI 316L. Wide braid in stainless steel AISI 304. Protective sheat in retractible PVC, according to UNE-EN 14800. Female- Female connection free nut, Rp1/2" x Rp1/2" ISO 7/1 (UNE-EN 10266). Maximum working pressure 0,5 bar. Length available 1m.

3652 04 100	-	-	-	-
-------------	---	---	---	---



Ref. 3500



Válvula recta para gas, H-H

Acabado superficial cromado. Extremos rosca según ISO 7/1 (EN 10226). Mando palanca acero con recubrimiento DACROMET precintable.

Gas straight valve, F-F

Chrome-plated surface finishing. Thread ends according to ISO 7/1 (EN 10226). Sealable DACROMET covering steel lever handle.

R	P	L	A	M	t
1/2"	15	58	47	83	15,5
3/4"	20	65	58	97	16,5
1"	25	78	60,5	97	19,5
1 1/4"	32	88	74	125	20

CÓDIGO CODE	MEDIDA SIZE	PESO WEIGHT	CAJA / BOX CARTON	P.V.P. € PRICE €
3500 04	1/2"	0,187	10-180	-
3500 05	3/4"	0,305	8-96	-
3500 06	1"	0,450	6-60	-
3500 07	1 1/4"	0,725	6-48	-

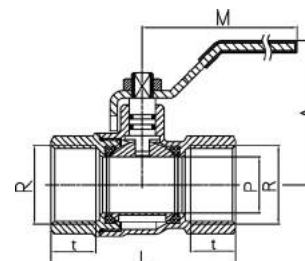

Ref. 3505



Válvula recta para gas, H-H

Acabado superficial cromado. Extremos rosca según ISO 7/1 (EN 10226). Mando palomilla aluminio precintable.

Gas straight valve, F-F

Chrome-plated surface finishing. Thread ends according to ISO 7/1 (EN 10226). Sealable aluminium butterfly handle.

R	P	L	A	M	t
1/2"	15	58	35,5	50	15,5
3/4"	20	65	44,5	62	16,5
1"	25	78	47	62	19,5

3505 04	1/2"	0,167	10-180	-
3505 05	3/4"	0,273	8-96	-
3505 06	1"	0,414	6-72	-

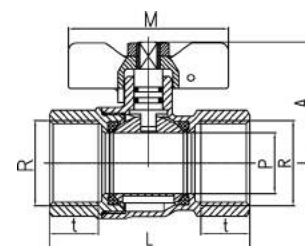

Ref. 3510



Válvula recta para gas, M-H

Acabado superficial cromado. Extremos rosca según ISO 7/1 (EN 10226). Mando palanca acero con recubrimiento DACROMET.

Gas straight valve, M-F

Chrome-plated surface finishing. Thread ends according to ISO 7/1 (EN 10226). Sealable DACROMET covering steel lever.

R	P	L	A	M	t	t1
1/2"	15	62,5	47	83	15,5	13,5
3/4"	20	69	58	97	16,5	14,5
1"	25	82,5	60,5	97	19,5	17,5
1 1/4"	32	91,5	74	125	20	19,5

3510 04	1/2"	0,184	10-180	-
3510 05	3/4"	0,299	8-96	-
3510 06	1"	0,450	6-72	-
3510 07	1 1/4"	0,690	6-48	-

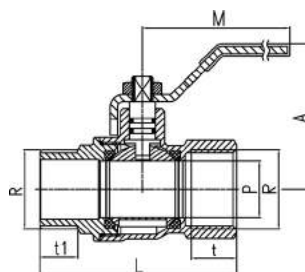

Ref. 3515



Válvula recta para gas, M-H

Acabado superficial cromado. Extremos rosca según ISO 7/1 (EN 10226). Mando palomilla aluminio precintable.

Gas straight valve, M-F

Chrome-plated surface finishing. Thread ends according to ISO 7/1 (EN 10226). Sealable aluminium butterfly handle.

R	P	L	A	M	t	t1
1/2"	15	62,5	35,5	50	15,5	13,5
3/4"	20	69	44,5	62	16,5	14,5
1"	25	82,5	47	62	19,5	17,5

3515 04	1/2"	0,163	10-180	-
3515 05	3/4"	0,265	8-96	-
3515 06	1"	0,413	6-72	-

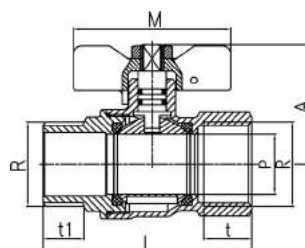

CÓDIGO CODE	MEDIDA SIZE	PESO WEIGHT	CAJA / BOX CARTON	P.V.P. € PRICE €
----------------	----------------	----------------	----------------------	---------------------

Ref. **3520**

Válvula recta para gas, H-conexión manguera
Acabado superficial cromado. Extremos rosca según ISO 7/1 (EN 10226). Mando palomilla aluminio precintable.

3520 04	1/2"	0,163	10-180	-
---------	------	-------	--------	---



Gas straight valve, F-hose connection
Chrome-plated surface finishing. Thread ends according to ISO 7/1 (EN 10226). Sealable aluminium butterfly handle.

R	P1	P	L	A	M	t	t1	D
1/2"	6	15	76,5	35,5	50	15,5	29	10,9

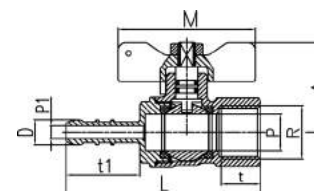

Ref. **3525**

Válvula recta para gas, M-conex. manguera
Acabado superficial cromado. Extremos rosca según ISO 7/1 (EN 10226). Mando palomilla aluminio.

3525 04	1/2"	0,154	10-180	-
---------	------	-------	--------	---



Gas straight valve, M-hose connection
Chrome-plated surface finishing. Thread ends according to ISO 7/1 (EN 10226). Sealable aluminium butterfly handle.

R	P1	P	L	A	M	t	t1	D
1/2"	6	15	76,5	35,5	27	14	29	10,9

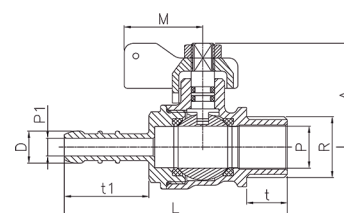

Ref. **3550**

Válvula escuadra para gas, M-M
Acabado superficial cromado. Extremos rosca según ISO 7/1 (EN 10226). Mando palomilla aluminio precintable.

3550 04	1/2"	0,162	10-180	-
---------	------	-------	--------	---



Gas square valve, M-M
Chrome-plated surface finishing. Thread ends according to ISO 7/1 (EN 10226). Sealable aluminium butterfly handle.

R	P	L	A	M	t	t1
1/2"	13,5	46	64,5	27	14	13,5

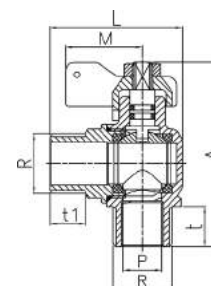

Ref. **3555**

Válvula escuadra para gas, M-F
Acabado superficial cromado. Extremos rosca según ISO 7/1 (EN 10226). Mando palomilla aluminio precintable.

3555 04	1/2"	0,162	10-180	-
---------	------	-------	--------	---



Gas square valve, M-F
Chrome-plated surface finishing. Thread ends according to ISO 7/1 (EN 10226). Sealable aluminium butterfly handle.

R	P	L	A	M	t	t1
1/2"	13,5	43	64,5	27	14	15

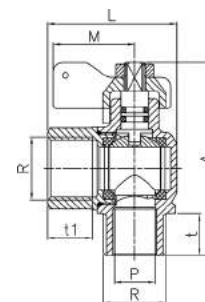

CÓDIGO CODE	MEDIDA SIZE	PESO WEIGHT	CAJA / BOX CARTON	P.V.P. € PRICE €
----------------	----------------	----------------	----------------------	---------------------

Ref. 3560



Válvula escuadra para gas, M-conexión manguera

Acabado superficial cromado. Extremos rosca según ISO 7/1 (EN 10226). Mando palomilla aluminio precintable.

Gas square valve, M-hose connection

Chrome-plated surface finishing. Thread ends according to ISO 7/1 (EN 10226). Sealable aluminium butterfly handle.

R	P1	P	L	A	M	t	t1	D
1/2"	6	13,5	61,5	64,5	27	14	29	10,9

3560 04	1/2"	0,162	10-180	-
---------	------	-------	--------	---

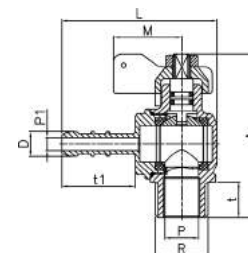

Ref. 3565



Válvula escuadra para gas, H-M

Acabado superficial cromado. Extremos rosca según ISO 7/1 (EN 10226). Mando palomilla aluminio precintable.

Gas square valve, F-M

Chrome-plated surface finishing. Thread ends according to ISO 7/1 (EN 10226). Sealable aluminium butterfly handle.

R	P	L	A	M	t	t1
1/2"	13,5	46	64,5	27	15,5	13,5

3565 04	1/2"	0,167	10-180	-
---------	------	-------	--------	---

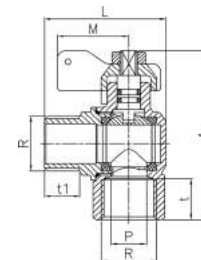

Ref. 3570N



Válvula escuadra para gas, H-H

Acabado superficial cromado. Extremos rosca según ISO 7/1 (EN 10226). Mando palomilla aluminio precintable.

Gas square valve, F-F

Chrome-plated surface finishing. Thread ends according to ISO 7/1 (EN 10226). Sealable aluminium butterfly handle.

R	P	L	A	M	t
1/2"	13,5	43	64,5	27	15,5

3570N 04	1/2"	0,170	10-180	-
----------	------	-------	--------	---

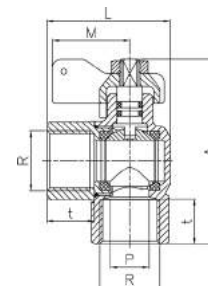

Ref. 3575



Válvula escuadra para gas, H-conexión manguera

Acabado superficial cromado. Extremos rosca según ISO 7/1 (EN 10226). Mando palomilla aluminio precintable.

Gas square valve, F-hose connection

Chrome-plated surface finishing. Thread ends according to ISO 7/1 (EN 10226). Sealable aluminium butterfly handle.

R	P	L	A	M	t	D
1/2"	6	61,5	64,5	27	15,5	10,9

3575 04	1/2"	0,169	10-180	-
---------	------	-------	--------	---

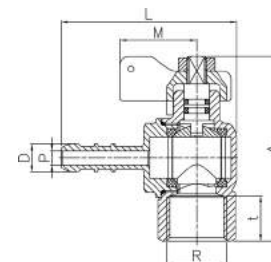

CÓDIGO CODE	MEDIDA SIZE	PESO WEIGHT	CAJA / BOX CARTON	P.V.P. € PRICE €
----------------	----------------	----------------	----------------------	---------------------

Ref. 70300

Kit de seguridad para gas

Detecta la presencia de gas metano en el ambiente. Para concentraciones del 10% de LIE (límite inferior explosividad). Incluye detector óptico-acústico con alarma y electroválvula. Alimentación 230 VCA 50-60 Hz. Sensor catalítico. IP 42. Dimensiones del dispositivo 138 x 85 x 44 mm.

Safety gas kit

To detect the presence of gas methane in the environment. For 10% of LEL (lower explosive limit) concentrations. Optical-acoustic detector with alarm and solenoid valve included. Power supply 230 VCA 50-60 Hz. Catalytic sensor. IP 42. Device dimensions 138 x 85 x 44 mm.

70300 04 00	1/2"	-	1	-
-------------	------	---	---	---



Ref. 3312

Filtro polivalente para gas

PN 16. Cuerpo latón UNE-EN 12165 cromado. Extremos rosca gas (BSP) H-H - ISO 228/1. Tamiz: acero inox. AISI 304. Luz: 50 micras. Junta tórica NBR. Temp. máx. 110°C.

In-line strainer for gas

PN 16. Body chrome plated brass UNE-EN 12165. Gas threaded ends (BSP) F-F - ISO 228/1. Sieve: stainless steel AISI 304. Light: 50 microns. NBR o-ring. Max. temp. 110°C.

3312 04	1/2"	0,130	10-160	-
3312 05	3/4"	0,220	8-80	-
3312 06	1"	0,350	6-60	-
3312 07	1 1/4"	0,655	5-30	-
3312 08	1 1/2"	0,980	2-12	-
3312 09	2"	1,530	1-8	-



R	D	L	M	A
1/2"	27	58	36	62
3/4"	33	74	43	76
1"	40	90	48	87
1 1/4"	49	115	56	105
1 1/2"	58	135	66	115
2"	71	161	80	135

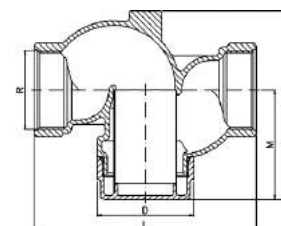



2018

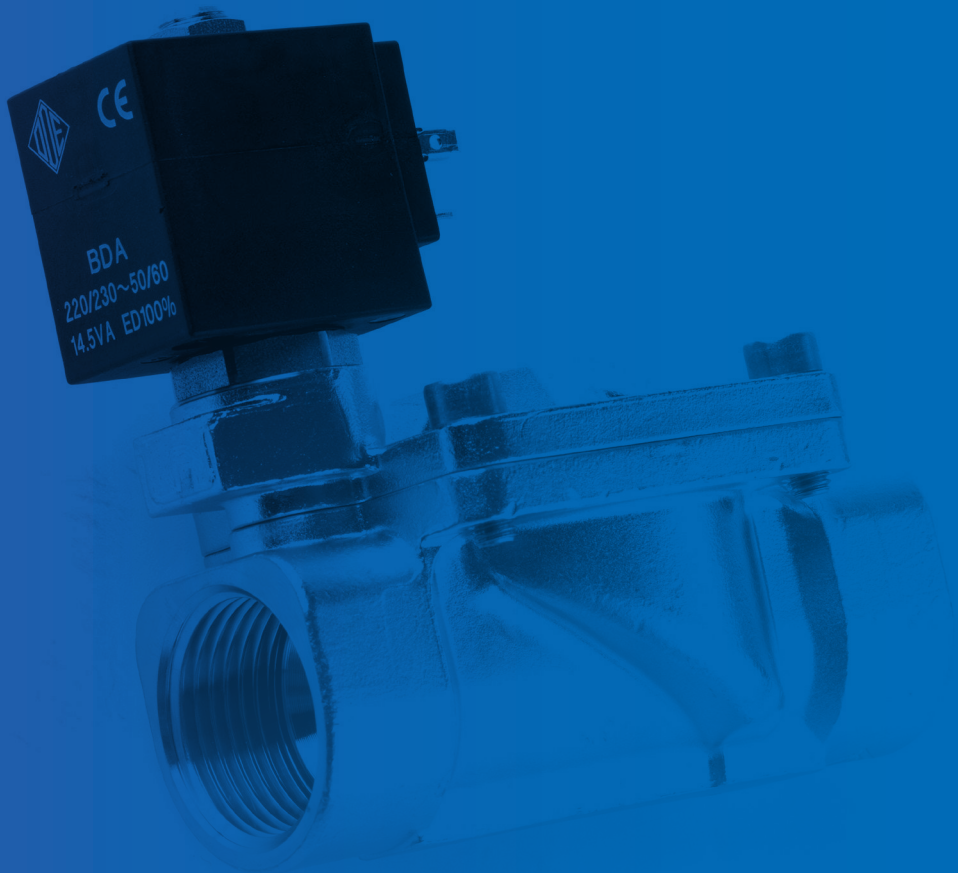

CE

BDA
220/230~50/60
14.5VA ED100%



ELECTROVÁLVULAS

SOLENOID VALVES

Gama completa de electroválvulas para diferentes aplicaciones en el sector industrial, en versiones de acción directa, indirecta y combinada.

Complete range of solenoid valves for different applications in the industrial sector, with 3 versions: direct, indirect and combined actioning.

ELECTROVÁLVULAS SOLENOID VALVES

PRINCIPALES TIPOS DE ELECTROVÁLVULAS MAIN TYPES OF SOLENOID VALVES

ACCIÓN DIRECTA (2 O 3 VÍAS) DIRECT ACTING (2 AND 3 WAYS)

Las electroválvulas de Acción Directa, por diseño, permiten trabajar en las siguientes condiciones:

- caudal máximo de 9 l/min (orificio máx. de 5,5 mm)
- diferencial de presión $\Delta P \geq 0$ bar entre la entrada y la salida.

The design of Direct Acting solenoid valves allow working under this conditions:

- 9 l/min maximum flow rate (max. orifice 5,5 mm)
- pressure difference $\Delta P \geq 0$ bar between inlet and outlet.

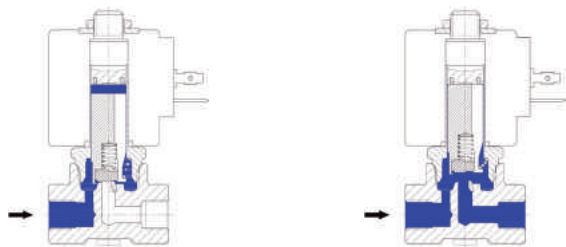

Bobina desenergizada / Coil de-energized
Electroválvula cerrada / Solenoid valve closed

Bobina energizada / Coil energized
Electroválvula abierta / Solenoid valve open

ACCIÓN INDIRECTA (2 VÍAS) INDIRECT ACTING (2 WAYS)

Las electroválvulas de Acción Indirecta, por diseño, permiten trabajar en las siguientes condiciones:

- caudal máximo 750 l/min (orificio máx. 50 mm)
- diferencial de presión mínimo ΔP 0,2 bar.

The design of Indirect Acting solenoid valves allow working under this conditions:

- 750 l/min maximum flow rate (max. orifice 50 mm)
- Pressure difference ΔP 0,2 bar minimum between inlet and outlet.

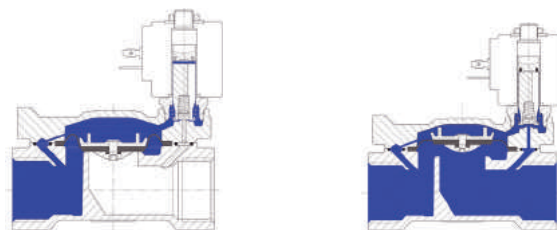

Bobina desenergizada / Coil de-energized
Electroválvula cerrada / Solenoid valve closed

Bobina energizada / Coil energized
Electroválvula abierta / Solenoid valve open

ACCIÓN MIXTA O COMBINADA (2 VÍAS) COMBINED ACTING (2WAYS)

Las electroválvulas de Acción Mixta, por diseño, permite trabajar en las siguientes condiciones:

- caudal máximo 140 l/min (orificio máx. 25 mm)
- diferencial de presión $\Delta P \geq 0$ bar entre la entrada y la salida.

The design of Combined Acting solenoid valves allow working under this conditions:

- 140 l/min maximum flow rate (max orifice 25 mm)
- pressure difference $\Delta P \geq 0$ bar between inlet and outlet.

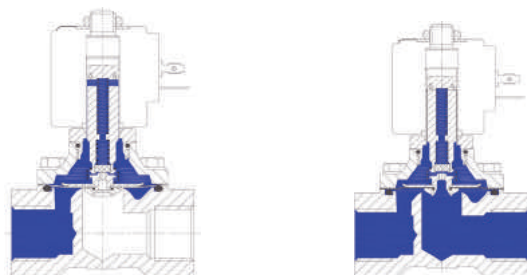

Bobina desenergizada / Coil de-energized
Electroválvula cerrada / Solenoid valve closed

Bobina energizada / Coil energized
Electroválvula abierta / Solenoid valve open

CÓMO SE CODIFICAN LA ELECTROVÁLVULAS HOW IS THE CODIFICATION FOR SOLENOID VALVES

4XXX XX XXXV

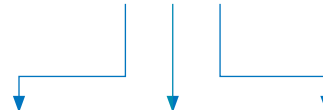

ELECTROVÁLVULA
SOLENOID VALVE

- 2/2 vías / ways
- N.C - Normalmente Cerrada
Normally closed
- Acción Mixta /
Mixed acting

MEDIDA
SIZE

- 00: b/pl
- 01: G 1/8"
- 02: G 1/4"
- 03: G 3/8"
- 04: G 1/2"
- 05: G 3/4"
- 06: G 1"
- 07: G 1 1/4"
- 08: G 1 1/2"
- 09: G 2"

BOBINA
COIL

- A12V: 12V AC - 50Hz
- C12V: 12V DC
- C24V: 24V DC
- A24V: 24V AC - 50/60Hz
- 110V: 110V AC - 50/60Hz
- 220V: 220/230V AC - 50/60Hz

Ref. 4030 - 4031



Electroválvula de acción directa 2 vías N.C.
 PN 40. Normalmente cerrada. Acción directa. Temperatura del fluido -10°C / +140°C. Cuerpo en latón UNE-EN 12165. Piloto mando Acero Inox. Cierre de FKM (otros cierres consultar). Bobina 8W.

2 ways direct acting solenoid valve N.C
 PN 40. Normally closed. Direct acting. Fluid temperature -10°C / +140°C. Body brass UNE-EN 12165. Stainless steel control pilot. FKM sealing (consult for other sealings). Coil 8W.

(4031)
 Igual características anterior con bobina 14 W
 Same characteristics as above coil 14 W

Recambios
 Conjunto núcleo móvil - E020V
 Conjunto tubo guía - E025

Spare parts
 Plunger set - E020V
 Conductor pipe set - E025

CÓDIGO CODE	MEDIDA SIZE	PESO WEIGHT	CAJA / BOX CARTON	P.V.P. € PRICE €
-------------	-------------	-------------	-------------------	------------------

4030 01	1/8"	0,300	1	-
4030 02	1/4"	0,300	1	-

4031 01	1/8"	0,580	1	-
4031 02	1/4"	0,580	1	-

E020V	-	-	1	-
E025	-	-	1	-

Ref.	DN	PN	A mm.	B mm.	C mm.	Ø	Presiones / Pressure			Potencia / Power		Kv
							max. M.O.P.D.			(watt)	l/min	
							min. bar	AC bar	DC bar			
4030 01	1/8"	40	28	78	40	2,5	0	14	9	8	3,2	
4030 02	1/4"	40	28	78	40	2,5	0	14	9	8	3,2	
4031 01	1/8"	40	28	78	40	2,5	0	30	25	14	3,2	
4031 02	1/4"	40	28	78	40	2,5	0	30	25	14	3,2	

BOBINA	D (mm)	E (mm)	F (mm)
8 W	30	42	54
14 W	52	55	67

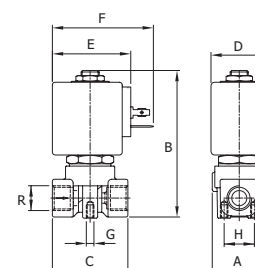

Ref. 4030Q

NEW



Electroválvula de acción directa 2 vías N.C.
 PN 40. Normalmente cerrada. Acción directa. Temperatura del fluido -10°C / +140°C. Cuerpo en latón UNE-EN 12165. Piloto mando Acero Inox. Cierre de FKM (otros cierres consultar). Bobina 8W con certificación CE-UL-CSA-VDE.

2 ways direct acting solenoid valve N.C
 PN 40. Normally closed. Direct acting. Fluid temperature -10°C / +140°C. Body brass UNE-EN 12165. Stainless steel control pilot. FKM sealing (consult for other sealings). 8W coil certified CE-UL-CSA-VDE.

Recambios
 Conjunto núcleo móvil - E020V
 Conjunto tubo guía - E025

Spare parts
 Plunger set - E020V
 Conductor pipe set - E025

4030Q 01	1/8"	0,300	-	-
----------	------	-------	---	---

E020V	-	-	1	-
E025	-	-	1	-

DN	PN	A mm.	B mm.	C mm.	Ø	Presiones / Pressure			Potencia / Power		Kv
						max. M.O.P.D.			(watt)	l/min	
						min. bar	AC bar	DC bar			
1/8"	40	28	78	40	2,5	0	14	9	8	3,2	

BOBINA	8W
D (mm)	30
E (mm)	42
F (mm)	54

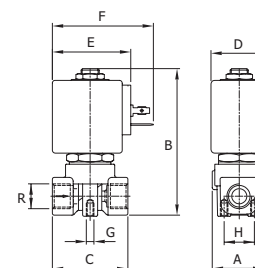

CÓDIGO CODE	MEDIDA SIZE	PESO WEIGHT	CAJA / BOX CARTON	P.V.P. € PRICE €
-------------	-------------	-------------	-------------------	------------------

Ref. 4032

NEW



Electroválvula de acción directa 2 vías N.C. Certificación NSF.
 PN 40. Normalmente cerrada. Acción directa. Temperatura del fluido -10°C / +140°C. Cuerpo en latón UNE-EN 12165. Piloto mando Acero Inox. Cierre de FKM (otros cierres consultar). Certificación NSF. Bobina 8W con certificación CE-UL-CSA-VDE.

2 ways direct acting solenoid valve N.C. NSF certification.
 PN 40. Normally closed. Direct acting. Fluid temperature -10°C / +140°C. Body brass UNE-EN 12165. Stainless steel control pilot. FKM sealing (consult for other sealings). NSF certification. 8W coil certified CE-UL-CSA-VDE.

DN	PN	A mm.	B mm.	C mm.	Ø	Presiones / Pressure			Potencia / Power (watt)	Kv
						min.	max. M.O.P.D.			
					mm	bar	AC bar	DC bar		l/min
1/8"	40	28	78	40	2,5	0	14	9	8	3,2

BOBINA	8 W
D (mm)	30
E (mm)	42
F (mm)	54

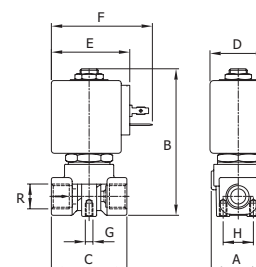

Ref. 4210



Electroválvula de acción directa 2 vías N.C.
 PN 25. Normalmente cerrada. Acción directa. Temperatura del fluido -10°C / +140°C. Cuerpo en latón UNE-EN 12165. Piloto mando Acero Inox. Cierre de FKM (otros cierres consultar). Bobina 5W.

2 ways direct acting solenoid valve N.C.
 PN 25. Normally closed. Direct acting. Fluid temperature -10°C / +140°C. Body brass UNE-EN 12165. Stainless steel control pilot. FKM sealing (consult for other sealings). Coil 5W.

DN	PN	A mm.	B mm.	C mm.	Ø	Presiones / Pressure			Potencia / Power (watt)	Kv
						min.	max. M.O.P.D.			
					mm	bar	AC bar	DC bar		l/min
1/8"	25	25	56	30	2,3	0	18	8	5	2,3

BOBINA	5 W
D (mm)	22
E (mm)	28
F (mm)	40

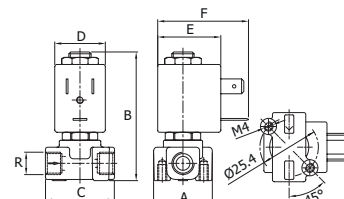

Ref. 4220



Electroválvula de acción directa 2 vías N.C.
 PN 40. Normalmente cerrada. Acción directa. Temperatura del fluido -10°C / +140°C. Cuerpo en latón UNE-EN 12165. Piloto mando Acero Inox. Cierre de FKM. Bobina 8W.

2 ways direct acting solenoid valve N.C.
 PN 40. Normally closed. Direct acting. Fluid temperature -10°C / +140°C. Body brass UNE-EN 12165. Stainless steel control pilot. FKM sealing. Coil 8W.

Recambios
 Conjunto núcleo móvil 1/8"-1/4" - E026V
 Conjunto núcleo móvil 3/8"-1/2" - E027V

Spare parts
 Plunger set 1/8"-1/4" - E026V
 Plunger set 3/8"-1/2" - E027V

DN	PN	A mm.	B mm.	C mm.	Ø	Presiones / Pressure			Potencia / Power (watt)	Kv
						min.	max. M.O.P.D.			
					mm	bar	AC bar	DC bar		l/min
1/8"	40	17	63	37	2,8	0	14	10	8	3,5
1/4"	40	17	63	37	2,8	0	14	10	8	3,5
3/8"	40	26	76	46	4,5	0	5	2	8	6,5
1/2"	40	26	76	58	5,5	0	3	1	8	9

BOBINA	D (mm)	E (mm)	F (mm)
8 W	30	42	54

4220 01	1/8"	0,230	1	-
4220 02	1/4"	0,220	1	-
4220 03	3/8"	0,370	1	-
4220 04	1/2"	0,310	1	-

E026V	1/8" - 1/4"	-	1	-
E027V	3/8" - 1/2"	-	1	-

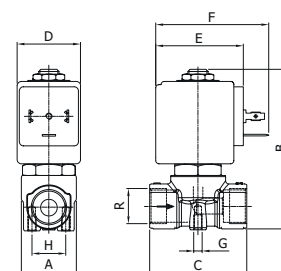

Ref. 4221

NEW



Electroválvula de acción directa 2 vías N.C.
 PN 40. Normalmente cerrada. Acción directa. Temperatura del fluido -10°C / +140°C. Cuerpo en latón UNE-EN 12165. Piloto mando Acero Inox. Cierre de FKM. Bobina 8W con cable saliente.

2 ways direct acting solenoid valve N.C.
 PN 40. Normally closed. Direct acting. Fluid temperature -10°C / +140°C. Body brass UNE-EN 12165. Stainless steel control pilot. FKM sealing. Coil 8W with external wire.

Recambios
 Conjunto núcleo móvil 1/8"-1/4" - E026V
 Conjunto núcleo móvil 3/8"-1/2" - E027V

Spare parts
 Plunger set 1/8"-1/4" - E026V
 Plunger set 3/8"-1/2" - E027V

DN	PN	A mm.	B mm.	C mm.	Ø	Presiones / Pressure			Potencia / Power		Kv
						min.	max. M.O.P.D.		(watt)	l/min	
					mm	bar	AC bar	DC bar			
1/4"	40	17	63	37	2,8	0	14	10	8	3,5	
3/8"	40	26	76	46	4,5	0	5	2	8	6,5	

BOBINA	8 W
D (mm)	30
E (mm)	42
F (mm)	54

CÓDIGO CODE	MEDIDA SIZE	PESO WEIGHT	CAJA / BOX CARTON	P.V.P. € PRICE €
4221 02	1/4"	0,220	-	-
4221 03	3/8"	0,370	-	-

E026V	1/8" - 1/4"	-	1	-
E027V	3/8" - 1/2"	-	1	-

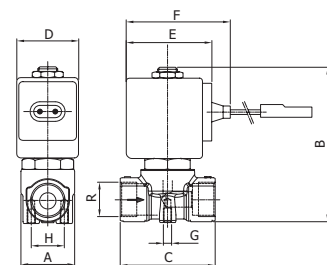

Ref. 4222

NEW



Electroválvula de acción directa 2 vías N.C.
 PN 40. Normalmente cerrada. Acción directa. Temperatura del fluido -10°C / +140°C. Cuerpo en latón UNE-EN 12165. Piloto mando Acero Inox. Cierre de FKM. Bobina 8W con certificación CE-UL-CSA-VDE.

2 ways direct acting solenoid valve N.C.
 PN 40. Normally closed. Direct acting. Fluid temperature -10°C / +140°C. Body brass UNE-EN 12165. Stainless steel control pilot. FKM sealing. 8W coil certified CE-UL-CSA-VDE.

Recambios
 Conjunto núcleo móvil 1/8"-1/4" - E026V

Spare parts
 Plunger set 1/8"-1/4" - E026V

DN	PN	A mm.	B mm.	C mm.	Ø	Presiones / Pressure			Potencia / Power		Kv
						min.	max. M.O.P.D.		(watt)	l/min	
					mm	bar	AC bar	DC bar			
1/8"	40	17	63	37	2,8	0	14	10	8	3,5	

BOBINA	8 W
D (mm)	30
E (mm)	42
F (mm)	54

4222 01	1/8"	0,240	-	-
---------	------	-------	---	---

E026V	1/8" - 1/4"	-	1	-
-------	-------------	---	---	---

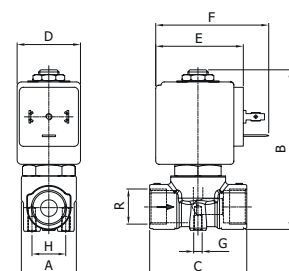

Ref. 4223RC

NEW



Electroválvula de acción directa 2 vías N.C.
 PN 130. Normalmente cerrada. Acción directa. Temperatura del fluido -40°C / +180°C. Cuerpo en latón UNE-EN 12165. Piloto mando Acero Inox. Cierre de Rubí. Bobina 14W con certificación CE-UL-CSA-VDE.

2 ways direct acting solenoid valve N.C.
 PN 130. Normally closed. Direct acting. Fluid temperature -40°C / +180°C. Body brass UNE-EN 12165. Stainless steel control pilot. Ruby sealing. 14W coil certified CE-UL-CSA-VDE.

DN	PN	A mm.	B mm.	C mm.	Ø	Presiones / Pressure			Potencia / Power		Kv
						min.	max. M.O.P.D.		(watt)	l/min	
					mm	bar	AC bar	DC bar			
1/4"	130	28	78	40	1,2	0	130	130	14	1	

BOBINA	14 W
D (mm)	52
E (mm)	55
F (mm)	67

4223RC 02	1/4"	-	-	-
-----------	------	---	---	---

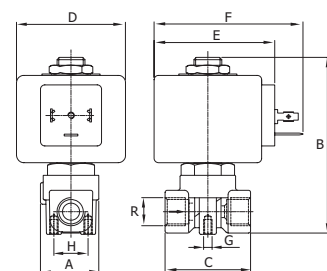

CÓDIGO MEDIDA PESO CAJA / BOX P.V.P. €
CODE SIZE WEIGHT CARTON PRICE €

Ref. 4232



Electroválvula de acción directa 2 vías N.C.
PN 40. Normalmente cerrada. Acción directa. Temperatura del fluido -10°C / +140°C. Cuerpo en latón UNE-EN 12165. Piloto mando Acero Inox. Cierre de FKM (otros cierres consultar). Bobina 8W.

2 ways direct acting solenoid valve N.C.
PN 40. Normally closed. Direct acting. Fluid temperature -10°C / +140°C. Body brass UNE-EN 12165. Stainless steel control pilot. FKM sealing (consult for other sealings). Coil 8W.

Recambios
Conjunto núcleo móvil - E020V
Conjunto tubo guía - E025
Junta tórica inferior - 4825 00

Spare parts
Plunger set - E020V
Conductor pipe set - E025
Lower o'ring - 4825 00

4232 00	b/pl	0,260	1	-
---------	------	-------	---	---

E020V	-	-	1	-
E025	-	-	1	-
4825 00	-	-	1	-

PN	A mm.	B mm.	C mm.	Ø mm	Presiones / Pressure			Potencia / Power		Kv
					min. bar	max. M.O.P.D. AC bar	DC bar	(watt)	l/min	
40	32	63	32	2	0	22	16	8	2	

BOBINA	8 W
D (mm)	30
E (mm)	42
F (mm)	54

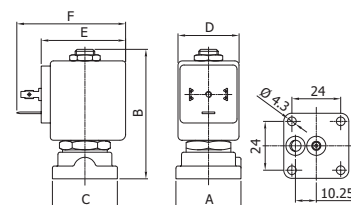

Ref. 4250



Electroválvula de acción directa 2 vías N.C.
Normalmente cerrada. Acción directa. Temperatura del fluido +2°C / +100°C. Cuerpo en latón UNE-EN 12165, PSU y PA. Piloto mando Acero Inox. Membrana VMQ (silicona), fluido separado para distribuidores automáticos de bebidas. Bobina 8W.

2 ways direct acting solenoid valve N.C.
Normally closed. Direct acting. Fluid temperature +2°C / + 100°C. Body brass UNE-EN 12165, PSU and PA. Stainless steel control pilot. VMQ (silicon) membrane, fluid separated for automatic drink distributors. Coil 8W.

4250 02	1/4"	0,280	1	-
---------	------	-------	---	---

DN	Ø mm	Presiones / Pressure			Potencia / Power		Kv
		min. bar	max. M.O.P.D. AC bar	DC bar	(watt)	l/min	
1/4"	9	0	0,3	0,3	8	2,5	

BOBINA	8 W
D (mm)	30
E (mm)	42
F (mm)	54

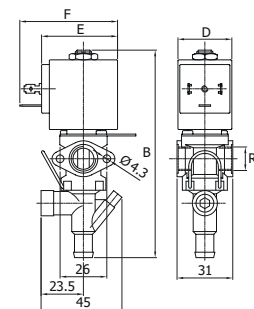

Ref. 4440



Electroválvula de acción directa 2 vías N.C.
PN 25. Normalmente cerrada. Paso angular. Acción directa. Temperatura del fluido -10°C / +140°C. Cuerpo en latón UNE-EN 12165. Piloto mando Acero Inox. Cierre de FKM. Bobina de 8W.

2 ways indirect acting solenoid valve N.C
PN 25. Normally closed. Angle bore. Direct acting. Fluid temperature -10°C / + 140°C. Body brass UNE-EN 12165. Stainless steel control pilot. FKM sealing. Coil 8W.

4440 02	1/4"	0,340	1	-
---------	------	-------	---	---

DN	PN	Ø mm	Presiones / Pressure			Potencia / Power		Kv	B	C
			min. bar	max. M.O.P.D. AC bar	DC bar	(watt)	l/min			
1/4"	25	3	0	10	4	8	4	84	32,5	

BOBINA	8 W
D (mm)	30
E (mm)	42
F (mm)	54

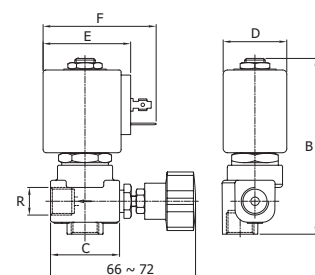

Ref. 4040 - 4041



Electroválvula de acción directa 2 vías N.A.
 PN 40. Normalmente abierta. Acción directa. Temperatura del fluido -10°C / +140°C. Cuerpo en latón UNE-EN 12165. Piloto mando Acero Inox. Cierre de FKM (otros cierres consultar). Bobina 8W.

2 ways direct acting solenoid valve N.O.
 PN 40. Normally open. Direct acting. Fluid temperature -10°C / +140°C. Body brass UNE-EN 12165. Stainless steel control pilot. FKM sealing (consult for other sealings). Coil 8W.

(4041)
 Igual características anterior con bobina 14 W.
 Same characteristics as above coil 14 W.

Recambios
 Conjunto núcleo móvil + conjunto tubo guía - E030V

Spare parts
 Plunger set & conductor pipe set - E030V

CÓDIGO CODE	MEDIDA SIZE	PESO WEIGHT	CAJA / BOX CARTON	P.V.P. € PRICE €
-------------	-------------	-------------	-------------------	------------------

4040 01	1/8"	0,300	1	-
4040 02	1/4"	0,300	1	-

4041 01	1/8"	0,580	1	-
4041 02	1/4"	0,580	1	-

E030V	-	-	-	-
-------	---	---	---	---

Ref.	DN	PN	A mm.	B mm.	C mm.	Ø	Presiones / Pressure			Potencia / Power	
							max. M.O.P.D.			(watt)	l/min
							min. bar	AC bar	DC bar		
4040 01	1/8"	40	28	78	40	2,5	0	14	14	8	3,2
4041 01	1/8"	40	28	78	40	2,5	0	17	17	14	3,2
4040 02	1/4"	40	28	78	40	2,5	0	14	14	8	3,2
4041 02	1/4"	40	28	78	40	2,5	0	17	17	14	3,2

BOBINA	D (mm)	E (mm)	F (mm)
8 W	30	42	54
14 W	52	55	67

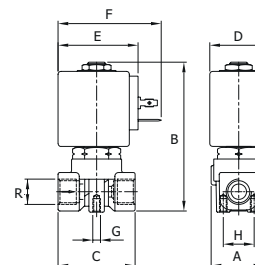

Ref. 4240



Electroválvula de acción directa 2 vías N.A.
 PN 25. Normalmente abierta. Acción directa. Temperatura del fluido -10°C / +140°C. Cuerpo en latón UNE-EN 12165. Piloto mando Acero Inox. Cierre de FKM. Bobina 8W.

2 ways direct acting solenoid valve N.O.
 PN 25. Normally opened. Direct acting. Fluid temperature -10°C / +140°C. Body brass UNE-EN 12165. Stainless steel control pilot. FKM sealing. Coil 8W.

4240 01	1/8"	0,230	1	-
---------	------	-------	---	---

DN	PN	Ø	Presiones / Pressure			Potencia / Power (watt)	Kv l/min	A	B	C
			min. bar	AC bar	DC bar					
1/8"	25	2,5	0	18	18	8	3,5	24	81	27

BOBINA	8 W
D (mm)	30
E (mm)	42
F (mm)	54

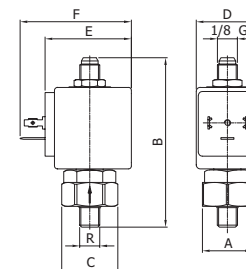

Ref. 4340



Electroválvula de acción directa 3 vías N.C.
 PN 40. Normalmente cerrada. Acción directa. Paso interior Ø 1,2. Paso tubo superior Ø 1,5. Temperatura del fluido -10°C / +140°C. Cuerpo en latón UNE-EN 12165. Piloto mando Acero Inox. Cierre de FKM. Bobina 5W.

3 ways direct acting solenoid valve N.C.
 PN 40. Normally closed. Direct acting. Internal bore Ø 1,2. Top cone bore Ø 1,5. Fluid temperature -10°C / +140°C. Body brass UNE-EN 12165. Stainless steel control pilot. FKM sealing. Coil 5W.

4340 01	1/8"	0,130	1	-
---------	------	-------	---	---

Ref.	DN	PN	A mm.	B mm.	C mm.	Ø	Presiones / Pressure			Potencia / Power	
							máx. M.O.P.D.			(watt)	l/min
							min. bar	AC bar	DC bar		
4340 01	1/8"	40	25	56	30	1,2	0	15	15	5	1

BOBINA	5 W
D (mm)	22
E (mm)	28
F (mm)	40

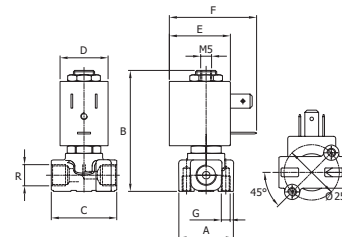

Ref. **4322 - 4324 - 4328 - 4320**



(4322)
Igual características que la anterior.
Paso interior Ø 2. Paso tubo superior Ø 2,5
Same characteristics as above.
Internal bore Ø 2. Top cone bore Ø 2,5

(4324)
Igual características que la anterior.
Paso interior Ø 1,5. Paso tubo superior Ø 2,5
Same characteristics as above.
Internal bore Ø 1,5. Top cone bore Ø 2,5

(4328)
Igual características que la anterior.
Paso interior Ø 1,5. Paso tubo superior Ø 1,5
Same characteristics as above.
Internal bore Ø 1,5. Top cone bore Ø 1,5

(4320) Electroválvula de acción directa 3 vías N.C.
PN 40. Normalmente cerrada. Acción directa. Paso interior Ø 2,5. Paso tubo superior Ø 2,5. Temperatura del fluido -10°C / +140°C. Cuerpo en latón UNE-EN 12165. Piloto mando Acero Inox. Cierre de FKM. Bobina 8W.

(4320) 3 ways direct acting solenoid valve N.C.
PN 40. Normally closed. Direct acting. Internal bore Ø 2,5. Top cone bore Ø 2,5. Fluid temperature -10°C / + 140°C. Body brass UNE-EN 12165. Stainless steel control pilot. FKM sealing. Coil 8W.

Recambios
Conjunto núcleo móvil - E038V
Conjunto núcleo móvil - E039V
Conjunto tubo guía - E035

Spare parts
Plunger set - E038V
Plunger set - E039V
Conductor pipe set - E035

CÓDIGO MEDIDA PESO CAJA / BOX P.V.P. €
CODE SIZE WEIGHT CARTON PRICE €

4322 01	1/8"	0,320	1	-
4322 02	1/4"	0,300	1	-

4324 01	1/8"	0,320	1	-
4324 02	1/4"	0,300	1	-

4328 01	1/8"	0,320	1	-
4328 02	1/4"	0,300	1	-

4320 01	1/8"	0,320	1	-
4320 02	1/4"	0,300	1	-

E038V	-	-	1	-
E039V	-	-	1	-
E035	-	-	1	-

Ref.	DN	PN	Ø	Presiones / Pressure				Potencia / Power (watt)	Kv	A mm.	B mm.	C mm.
				min. bar	máx. M.O.P.D.		DC bar					
					AC bar	DC bar						
4324 01	1/8"	40	27,5	86	40	1,5	0	15	15	8	1,4	
4328 01	1/8"	40	27,5	86	40	1,5	0	10	10	8	1,4	
4320 02	1/4"	40	27,5	86	40	2,5	0	6	6	8	3,2	
4322 02	1/4"	40	27,5	86	40	2	0	10	10	8	2	
4324 02	1/4"	40	27,5	86	40	1,5	0	15	15	8	1,4	
4328 02	1/4"	40	27,5	86	40	1,5	0	10	10	8	1,4	
4320 01	1/8"	40	27,5	86	40	2,5	0	6	6	8	3,2	
4322 01	1/8"	40	27,5	86	40	2	0	10	10	8	2	

BOBINA	8 W
D (mm)	30
E (mm)	42
F (mm)	54

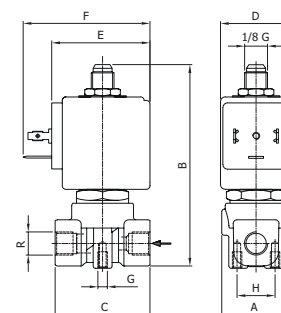

Ref. **4321**

NEW

Electroválvula de acción directa 3 vías N.C.
PN 40. Normalmente cerrada. Acción directa. Paso interior Ø 3. Paso tubo superior Ø 3. Temperatura del fluido -10°C / +140°C. Cuerpo en latón UNE-EN 12165. Piloto mando Acero Inox. Cierre de FKM. Bobina 8W.

3 ways direct acting solenoid valve N.C.
PN 40. Normally closed. Direct acting. Internal bore Ø 3. Top cone bore Ø 3. Fluid temperature -10°C / + 140°C. Body brass UNE-EN 12165. Stainless steel control pilot. FKM sealing. Coil 8W.

DN	PN	A mm.	B mm.	C mm.	Ø	Presiones / Pressure				Potencia / Power (watt)	Kv
						min. bar	máx. M.O.P.D.		DC bar		
							AC bar	DC bar			
1/4"	40	27,5	86	40	3	0	3,5	3,5	8	4	

BOBINA	8 W
D (mm)	30
E (mm)	42
F (mm)	54

4321 02	1/4"	0,300	-	-
---------	------	-------	---	---

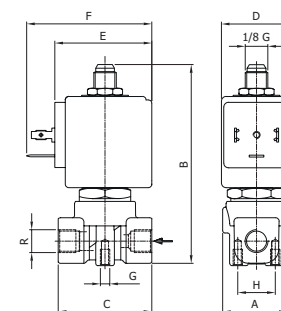

Ref. 4330 - 4332 - 4335



(4330) Electroválvula de acción directa 3 vías N.C.
 PN 40. Normalmente cerrada. Acción directa. Paso interior Ø 1,5. Paso tubo superior Ø 2,5. Temperatura del fluido -10°C / +140°C. Cuerpo en latón UNE-EN 12165. Piloto mando Acero Inox. Cierre de FKM. Bobina 8W.

(4330) 3 ways direct acting solenoid valve N.C.
 PN 40. Normally closed. Direct acting. Internal bore Ø 1,5. Top cone bore Ø 2,5. Fluid temperature -10°C / + 140°C. Body brass UNE-EN 12165. Stainless steel control pilot. FKM sealing. Coil 8W.

(4332)
 Igual características anterior. Paso interior Ø2.
 Same characteristics as above - bore Ø2.

(4335)
 Igual características anterior. Paso int. Ø1,5 cono superior tipo "C".
 Same characteristics as above - internal bore Ø1.5 top cone type "C".

Recambios
 Conjunto núcleo móvil - E038V
 Conjunto tubo guía - E035
 Junta tórica inferior - 4825 00

Spare parts
 Plunger set - E038V
 Conductor pipe set - E035
 Lower o'ring - 4825 00

CÓDIGO CODE	MEDIDA SIZE	PESO WEIGHT	CAJA / BOX CARTON	P.V.P. € PRICE €
-------------	-------------	-------------	-------------------	------------------

4330 00	b/pl	0,260	1	-
---------	------	-------	---	---

4332 00	b/pl	0,260	1	-
---------	------	-------	---	---

4335 00	b/pl	0,260	1	-
---------	------	-------	---	---

E038V	-	-	1	-
-------	---	---	---	---

E035	-	-	1	-
------	---	---	---	---

4825 00	-	-	1	-
---------	---	---	---	---

Ref.	PN	Ø mm	Presiones / Pressure			Potencia / Power (watt)	Kv l/min	A mm.	B mm.	C mm.
			min. bar	max. M.O.P.D. AC bar	DC bar					
4330 00	40	1,5	0	15	15	8	1,4	32	72	32
4332 00	40	2	0	10	10	8	2	32	72	32
4335 00	40	1,5	0	15	15	8	1,4	32	72	32

BOBINA	8 W
D (mm)	30
E (mm)	42
F (mm)	54

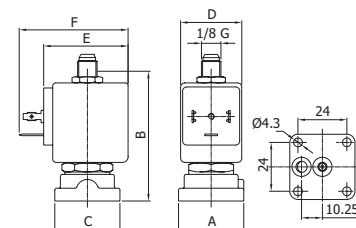

Ref. 4336

NEW

Electroválvula de acción directa 3 vías N.C. Bobina con cable saliente

PN 40. Normalmente cerrada. Acción directa. Paso interior Ø 1,5. Paso tubo superior Ø 2,5. Temperatura del fluido -40°C / +180°C. Cuerpo en latón UNE-EN 12165. Piloto mando Acero Inox. Cierre de Rubí. Bobina 8W.

3 ways direct acting solenoid valve N.C. With external wire coil
 PN 40. Normally closed. Direct acting. Internal bore Ø 1,5. Top cone bore Ø 2,5. Fluid temperature -40°C / + 180°C. Body brass UNE-EN 12165. Stainless steel control pilot. Ruby sealing. Coil 8W.

Recambios
 Junta tórica inferior - 4825 00

Spare parts
 Lower o'ring - 4825 00

CÓDIGO CODE	MEDIDA SIZE	PESO WEIGHT	CAJA / BOX CARTON	P.V.P. € PRICE €
-------------	-------------	-------------	-------------------	------------------

4336 00	b/pl	0,230	1	-
---------	------	-------	---	---

4825 00	-	-	1	-
---------	---	---	---	---

Ref.	PN	Ø mm	Presiones / Pressure			Potencia / Power (watt)	Kv l/min	A mm.	B mm.	C mm.
			min. bar	max. M.O.P.D. AC bar	DC bar					
4336 00	40	1,5	0	15	15	8	1,4	32	72	32

BOBINA	8 W
D (mm)	30
E (mm)	42
F (mm)	54

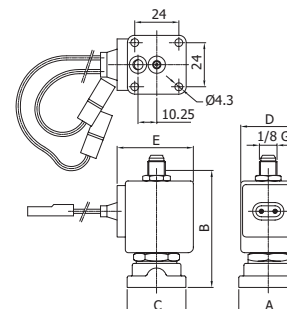

Ref. 4020 - 4022



Electroválvula de acción indirecta 2 vías N.C.
 También disponible con rosca NPT (ref. 4022)
 PN 16 - PN 23 - PN 25. Normalmente cerrada. Acción indirecta. Temperatura del fluido -10°C / +90°C. Cuerpo en latón UNE-EN 12165. Piloto mando Acero Inox. Membrana de NBR (bajo demanda FKM). Asiento cierre latón UNE-EN 12165. Bobina 8W.

2 ways indirect acting solenoid valve N.C.
 Also available NPT thread (ref. 4022)
 PN 16 - PN 23 - PN 25. Normally closed. Indirect acting. Fluid temperature -10°C / + 90°C. Body brass UNE-EN 12165. Stainless steel control pilot. NBR membrane (FKM on request). Orifice brass UNE-EN 12165. Coil 8W.

Recambios
 Conjunto núcleo móvil - E020B
 Conjunto tubo guía - E025
 Membrana 3/8"-1/2" - E025B
 Membrana 3/4"-1" - E022B
 Membrana 1 1/4"-1 1/2" - E023B
 Membrana 2" - E024B

Spare parts
 Plunger set - E020B
 Conductor pipe set - E025
 Membrane 3/8"-1/2" - E025B
 Membrane 3/4"-1" - E022B
 Membrane 1 1/4"-1 1/2" - E023B
 Membrane 2" - E024B

DN	PN	A mm.	B mm.	C mm.	Ø	Presiones / Pressure				Potencia / Power	
						min.		max. M.O.P.D.		(watt)	l/min
						mm	bar	AC bar	DC bar		
3/8"	25	40	97	60	13	0,2	16	16	8	60	
1/2"	25	40	97	66	13	0,2	16	16	8	70	
3/4"	23	65	105	104	19	0,2	16	16	8	140	
1"	23	65	112	104	25	0,2	16	16	8	190	
1 1/4"	16	98	125	144	35	0,2	10	10	8	400	
1 1/2"	16	98	125	144	40	0,2	10	10	8	520	
2"	16	118	141	172	50	0,2	10	10	8	750	

BOBINA	8 W
D (mm)	30
E (mm)	42
F (mm)	54

CÓDIGO CODE	MEDIDA SIZE	PESO WEIGHT	CAJA / BOX CARTON	P.V.P. € PRICE €
4020 03	3/8"	0,560	1	-
4020 04	1/2"	0,550	1	-
4020 05	3/4"	1,050	1	-
4020 06	1"	1,170	1	-
4020 07	1 1/4"	2,850	1	-
4020 08	1 1/2"	2,650	1	-
4020 09	2"	4,800	1	-

Precios rosca NPT a consultar / NPT thread prices on request

E020B	3/8" - 2"	-	-	-
E025	-	-	1	-
E025B	3/8"-1/2"	-	-	-
E022B	3/4"-1"	-	-	-
E023B	1 1/4"-1 1/2"	-	-	-
E024B	2"	-	-	-

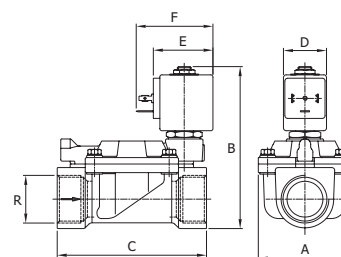

Ref. 4050



Electroválvula de acción indirecta 2 vías N.C.
 PN 16 - PN 20. Normalmente cerrada. Acción indirecta. Temperatura del fluido -10°C / +90°C. Cuerpo en latón UNE-EN 12165. Piloto mando Acero Inox. Membrana de NBR (otros cierres consultar). Bobina 8W.

2 ways indirect acting solenoid valve N.C.
 PN 16 - PN 20. Normally closed. Indirect acting. Fluid temperature -10°C / + 90°C. Body brass UNE-EN 12165. Stainless steel control pilot. NBR membrane (consult for other sealings). Coil 8W.

Recambios
 Conjunto núcleo móvil - E040B
 Conjunto membrana 3/8"-1/2" - E041B
 Conjunto membrana 3/4" - E042B

Spare parts
 Plunger set - E040B
 Membrane set 3/8"-1/2" - E041B
 Membrane set 3/4" - E042B

DN	PN	A mm.	B mm.	C mm.	Ø	Presiones / Pressure				Potencia / Power	
						min.		max. M.O.P.D.		(watt)	l/min
						mm	bar	AC bar	DC bar		
3/8"	20	40	92	50	12	0,1	20	10	8	35	
1/2"	20	40	92	50	12	0,1	20	10	8	45	
3/4"	16	50	92	65	18	0,1	16	3	8	50	

BOBINA	8 W
D (mm)	30
E (mm)	42
F (mm)	54

4050 03	3/8"	0,350	1	-
4050 04	1/2"	0,420	1	-
4050 05	3/4"	0,700	1	-

E040B	3/8" - 3/4"	-	1	-
E041B	3/8" - 1/2"	-	1	-
E042B	3/4"	-	1	-

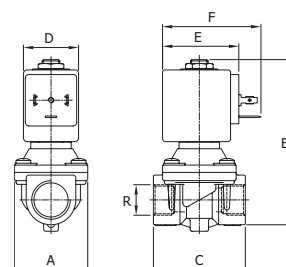

Ref. 4333

NEW

Electroválvula de acción indirecta 3 vías N.C. con pistón de control piloto

PN 100. Normalmente cerrada. Acción indirecta. Paso interior Ø 12. Temperatura del fluido -20°C / +95°C. Cuerpo en latón UNE-EN 12164. Piloto mando Acero Inox. Cierre de PBT. Bobina 8W con protección IP67.

3 ways indirect acting solenoid valve N.C. with piston pilot control PN 100. Normally closed. Indirect acting. Internal bore Ø 12. Fluid temperature -20°C / + 95°C. Body brass UNE-EN 12164. Stainless steel control pilot. PBT sealing. 8W coil with IP67 protection.

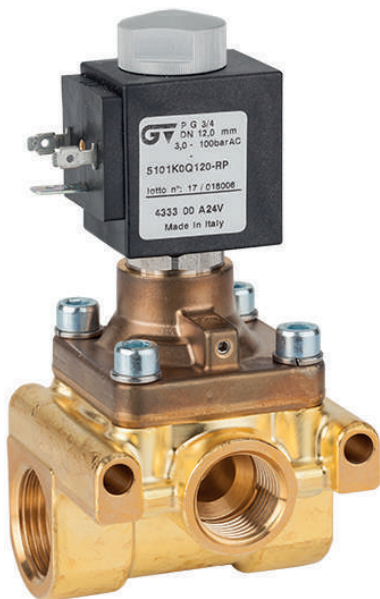

DN	PN	Ø	Presiones / Pressure			Potencia / Power		Kv
			min.	max. M.O.P.D.		(watt)	l/min	
3/4"	100	12	3	100	90	8	60	

BOBINA	8 W
D (mm)	30
E (mm)	42
F (mm)	54

CÓDIGO CODE	MEDIDA SIZE	PESO WEIGHT	CAJA / BOX CARTON	P.V.P. € PRICE €
4333 00	3/4"	1,100	-	-

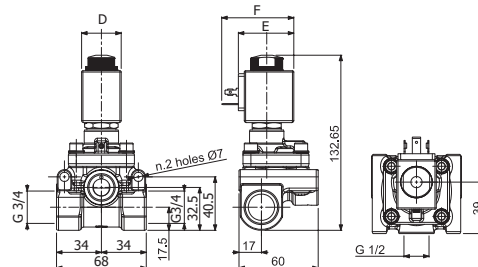

Ref. 4425

Electroválvula de acción indirecta 2 vías N.C.

También disponible con rosca NPT (ref. 4425N)
PN 25. Normalmente cerrada. Acción indirecta. Temperatura del fluido -40°C / +180°C. Cuerpo en latón UNE-EN 12165. Piloto mando Acero Inox. Cierre en PTFE. Bobina de 8W con protección IP67.

2 ways indirect acting solenoid valve N.C.
Also available NPT thread (ref. 4425N)
PN 25. Normally closed. Indirect acting. Fluid temperature -40°C / + 180°C. Body brass UNE-EN 12165. Stainless steel control pilot. PTFE sealing. 8W coil with IP67 protection.



Recambios
Conjunto tubo guía - E017

Spare parts
Conductor pipe set - E017

DN	PN	A mm.	B mm.	C mm.	Ø	Presiones / Pressure			Potencia / Power		Kv
						min.	max. M.O.P.D.		(watt)	l/min	
1/2"	25	40	107	65	13	0,9	10	10	8	50	
3/4"	25	48	120	74	19	0,9	10	10	8	90	
1"	25	62	130	93	25	0,9	10	10	8	160	

BOBINA	8 W
D (mm)	30
E (mm)	42
F (mm)	54

4425 04	1/2"	0,630	1	-
4425 05	3/4"	0,900	1	-
4425 06	1"	1,420	1	-

E017	1/2" - 1"	-	-	-
------	-----------	---	---	---

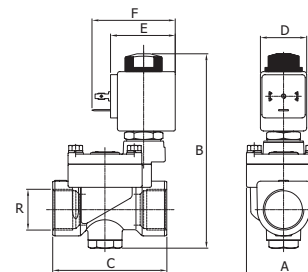

CÓDIGO MEDIDA PESO CAJA / BOX P.V.P. €
CODE SIZE WEIGHT CARTON PRICE €

Ref. 4021



Electroválvula de acción indirecta 2 vías N.A.

PN 16 - PN 25. Normalmente abierta. Acción indirecta. Temperatura del fluido -10°C / +90°C. Cuerpo en latón UNE-EN 12165. Piloto mando Acero Inox. Membrana de NBR (bajo demanda FKM). Asiento cierre latón UNE-EN 12165. Bobina 8W.

2 ways indirect acting solenoid valve N.O.

PN 16 - PN25. Normally open. Indirect acting. Fluid temperature -10°C / + 90°C. Body brass UNE-EN 12165. Stainless steel control pilot. NBR membrane (FKM on request). Orifice brass UNE-EN 12165. Coil 8W.

Recambios

- Conjunto tubo guía - E030 00
- Membrana 3/8"-1/2" - E025B
- Membrana 3/4"-1" - E022B
- Membrana 1 1/4"-1 1/2" - E023B
- Membrana 2" - E024B

Spare parts

- Conductor pipe set - E030 00
- Membrane 3/8"-1/2" - E025B
- Membrane 3/4"-1" - E022B
- Membrane 1 1/4"-1 1/2" - E023B
- Membrane 2" - E024B

4021 03	3/8"	0,560	1	-
4021 04	1/2"	0,550	1	-
4021 05	3/4"	1,050	1	-
4021 06	1"	1,170	1	-
4021 07	1 1/4"	2,850	1	-
4021 08	1 1/2"	2,650	1	-
4021 09	2"	4,800	1	-

E030 00	-	-	1	-
E025B	3/8"-1/2"	-	-	-
E022B	3/4"-1"	-	-	-
E023B	1 1/4"-1 1/2"	-	-	-
E024B	2"	-	-	-



DN	PN	A mm.	B mm.	C mm.	Ø	Presiones / Pressure			Potencia / Power	
						min. bar	max. M.O.P.D. AC bar DC bar		(watt)	Kv l/min
3/8"	25	40	97	60	13	0,2	16	16	8	60
1/2"	25	40	97	66	13	0,2	16	16	8	70
3/4"	25	65	105	104	19	0,2	16	16	8	140
1"	25	65	112	104	25	0,2	16	16	8	190
1 1/4"	16	98	125	144	35	0,2	10	10	8	400
1 1/2"	16	98	125	144	40	0,2	10	10	8	520
2"	16	118	141	172	50	0,2	10	10	8	750

BOBINA	8 W
D (mm)	30
E (mm)	42
F (mm)	54

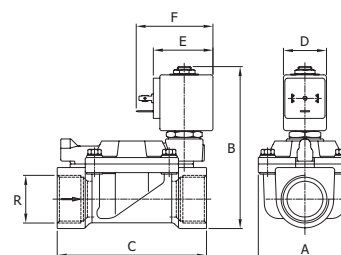

Ref. 4426



Electroválvula de acción indirecta 2 vías N.A.

PN 25. Normalmente abierta. Acción indirecta. Temperatura del fluido -40°C / +180°C. Cuerpo en latón UNE-EN 12165. Piloto mando Acero Inox. Cierre en PTFE. Bobina de 8W con protección IP67.

2 ways indirect acting solenoid valve N.O.

PN 25. Normally opened. Indirect acting. Fluid temperature -40°C / + 180°C. Body brass UNE-EN 12165. Stainless steel control pilot. PTFE sealing. 8W coil with IP67 protection.

4426 04	1/2"	0,630	1	-
4426 05	3/4"	0,900	1	-
4426 06	1"	1,420	1	-

DN	PN	A mm.	B mm.	C mm.	Ø	Presiones / Pressure			Potencia / Power	
						min. bar	max. M.O.P.D. AC bar DC bar		(watt)	Kv l/min
1/2"	25	40	107	65	13	0,9	10	10	8	50
3/4"	25	48	120	74	19	0,9	10	10	8	90
1"	25	62	130	93	25	0,9	10	10	8	160

BOBINA	8 W
D (mm)	30
E (mm)	42
F (mm)	54

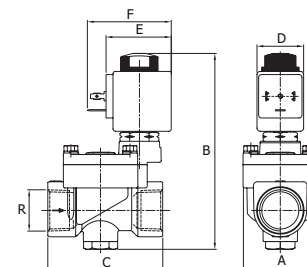

Ref. 4010



Electroválvula de acción mixta 2 vías N.C.

PN 16. Normalmente cerrada. Acción mixta. Temperatura del fluido -10°C / +90°C. Cuerpo en latón UNE-EN 12165. Piloto mando Acero Inox. Membrana de NBR+PA. Asiento cierre latón UNE-EN 12165. Bobina de 8W para medidas 3/8" a 3/4". Bobina de 14W para medida de 1".

2 ways mixed acting solenoid valve N.C.

PN 16. Normally closed. Mixed acting. Fluid temperature -10°C / + 90°C. Body brass UNE-EN 12165. Stainless steel control pilot. NBR+PA membrane. Orifice brass UNE-EN 12165. 8W coil for sizes from 3/8" to 3/4". 14W coil for size of 1".

Recambios

Conjunto membrana con núcleo móvil 3/8" - E011
 Conjunto membrana con núcleo móvil 1/2"-3/4" - E012
 Conjunto membrana con núcleo móvil 1" - E013

Spare parts

Membrane set with plunger 3/8" E011
 Membrane set with plunger 1/2"-3/4" E012
 Membrane set with plunger 1" E013

CÓDIGO CODE	MEDIDA SIZE	PESO WEIGHT	CAJA / BOX CARTON	P.V.P. € PRICE €
4010 03	3/8"	0,450	1	-
4010 04	1/2"	0,720	1	-
4010 05	3/4"	0,600	1	-
4010 06	1"	1,050	1	-

E011	3/8"	-	-	-
E012	1/2"-3/4"	-	-	-
E013	1"	-	-	-

DN	PN	A mm.	B mm.	C mm.	Ø	Presiones / Pressure			Potencia / Power		Kv
						min.	max. M.O.P.D.		(watt)	l/min	
3/8"	16	50	89	56	11	0	14	5	8	20	
1/2"	16	50	100	70	16	0	14	2,5	8	40	
3/4"	16	50	100	70	16	0	14	1,5	8	40	
1"	16	65	112	104	25	0	14	6	14	120	

BOBINA	D (mm)	E (mm)	F (mm)
8 W	30	42	54
14 W	52	55	67

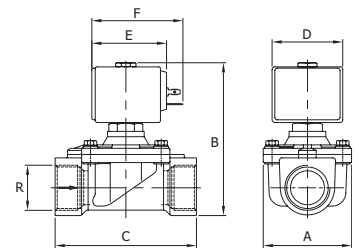

Ref. 4519



Electroválvula 5 vías

Acoplamiento conforme con la norma Namur 5 vías / 2 posiciones. Dispositivo de mando manual. Consumo 5 W. Grado de protección: IP 65 con conector y juntas. Racores: 1/4" gas. Presión de trabajo: min. 2 bar máx. 10 bar. Límite de temperaturas: -20°C +70°C.

5-ways solenoid valve

Coupling according norm Namur functioning 5 ways / 2 positions. Manual control device. Consumption 5 W. Protection: IP 65 with connector and seals. Connectors: 1/4" gas. Working pressure: min. 2 bar max. 10 bar. Temperature limits: -20°C +70°C.

4519 02 A12V	A12V	0,300	1-50	-
4519 02 C12V	C12V	0,300	1-50	-
4519 02 A24V	A24V	0,300	1-50	-
4519 02 C24V	C24V	0,300	1-50	-
4519 02 A48V	A48V	0,300	1-50	-
4519 02 C48V	C48V	0,300	-	-
4519 02 110V	110V	0,300	1-50	-
4519 02 220V	220V	0,300	1-50	-

Ref. 4100



Temporizador para descarga de condensados

Instrumento de control creado expresamente para válvulas de descarga. "Timer on" con su tiempo variable de 0,5 a 10 segundos. El "Timer off" regula a su vez el intervalo entre dos ciclos de apertura y puede variar de 0,5 a 45 minutos. Dos leds indican el estado de funcionamiento.

Condensate removal timer

Timer is a plug-on controller specially design for drain valves. The draining time can be set via the "on" timer between 0,5 and 10 seconds. The "off" timer allows to adjust the delay time between two draining cycles from 0,5 to 45 minutes. Two leds indicate the output status.

4100	-	0,413	1-125	-
------	---	-------	-------	---

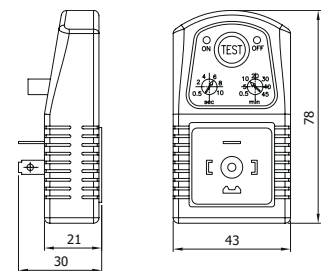

Tensión alimentación Salida / Output voltage	24 a 240VAC / DC10% 50/60 Hz
Corriente Salida / Output current	Max. 1 A
Consumo corriente / Power consumption	Max. 8 mA
Temperatura trabajo / Working temperature	-5°C a +60°C
Dimensiones / Dimensions	78 x 43 mm
Apertura / On time	0,5 a 10 segundos
Cierre / Off time	0,5 a 45 minutos

CÓDIGO MEDIDA PESO CAJA / BOX P.V.P. €
CODE SIZE WEIGHT CARTON PRICE €

Ref. 4630

Electroválvula de acción indirecta 2 vías N.C.

PN 22 - PN 25 - PN 40. Normalmente cerrada. Acción indirecta (1/4" acción directa). Temperatura del fluido -40°C / +180°C. Cuerpo en Acero inoxidable AISI 316. Piloto mando Acero Inox. Membrana PTFE. Asiento cierre Acero inox. Bobina 8W.

2 ways indirect acting solenoid valve N.C.

PN22 - PN 25 - PN 40. Normally closed. Indirect acting (1/4" direct acting). Fluid temperature -40°C / + 180°C. Body Stainless steel AISI 316. Stainless steel control pilot. PTFE membrane. Orifice stainless steel. Coil 8W.

Recambios

Conjunto tubo guía - E025
Cjto. núcleo - E020T
Membrana 3/8"-1/2" - E049T
Membrana 3/4"-1" - E050T

Spare parts

Conductor pipe set - E025
Plunger set - E020T
Membrane 3/8"-1/2" - E049T
Membrane 3/4"-1" - E050T

4630 02	1/4"	0,280	1	-
4630 04	1/2"	0,560	1	-
4630 05	3/4"	1,220	1	-
4630 06	1"	1,110	1	-

E025	-	-	1	-
E020T	1/4" - 1"	-	1	-
E049T	1/2"	-	1	-
E050T	3/4" - 1"	-	1	-



DN	PN	A mm.	B mm.	C mm.	Ø	Presiones / Pressure			Potencia / Power		Kv
						min. bar	max. M.O.P.D. AC bar DC bar		(watt)	l/min	
1/4"	40	28	78	39	3	0	10	6	8	4	
1/2"	25	40	103	73	12	0,5	10	10	8	35	
3/4"	22	65	115	104	19	0,5	10	10	8	120	
1"	22	65	115	104	25	0,5	10	10	8	130	

BOBINA	8 W
D (mm)	30
E (mm)	42
F (mm)	54

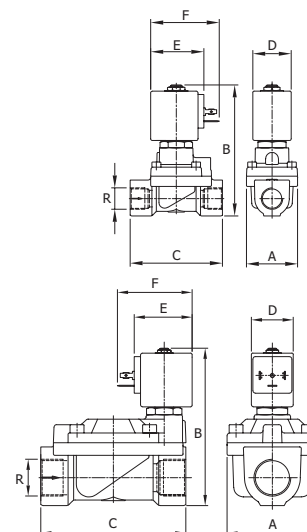

Ref. 4631

NEW

Electroválvula de acción indirecta 2 vías N.A.

PN 22 - PN 25 - PN 40. Normalmente abierta. Acción indirecta (1/4" acción directa). Temperatura del fluido -40°C / +180°C. Cuerpo en Acero inoxidable AISI 316. Piloto mando Acero Inox. Membrana PTFE. Asiento cierre Acero inox. Bobina 8W.

2 ways indirect acting solenoid valve N.O.

PN22 - PN 25 - PN 40. Normally opened. Indirect acting (1/4" direct acting). Fluid temperature -40°C / + 180°C. Body Stainless steel AISI 316. Stainless steel control pilot. PTFE membrane. Orifice stainless steel. Coil 8W.

4631 02	1/4"	0,280	-	-
4631 04	1/2"	0,560	-	-
4631 05	3/4"	1,220	-	-
4631 06	1"	1,110	-	-

*Bajo demanda / On request

DN	PN	A mm.	B mm.	C mm.	Ø	Presiones / Pressure			Potencia / Power		Kv
						min. bar	max. M.O.P.D. AC bar DC bar		(watt)	l/min	
1/4"	40	28	78	39	3	0	10	6	8	4	
1/2"	25	40	103	73	12	0,5	10	10	8	35	
3/4"	22	65	115	104	19	0,5	10	10	8	120	
1"	22	65	115	104	25	0,5	10	10	8	130	

BOBINA	8 W
D (mm)	30
E (mm)	42
F (mm)	54

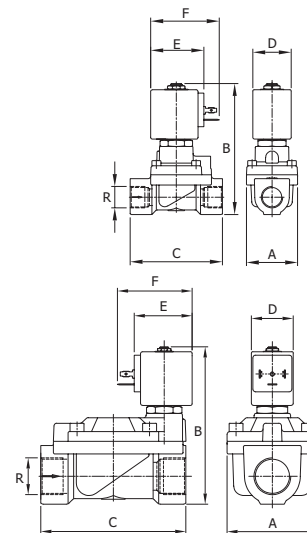

Ref. 4632



Electroválvula de acción indirecta 2 vías N.C.

PN 22 - PN 25. Normalmente cerrada. Acción indirecta. Temperatura del fluido -10°C / +140°C. Cuerpo en Acero inoxidable AISI 316. Piloto mando Acero Inox. Membrana FKM. Asiento cierre Acero inox. Bobina 8W.

2 ways indirect acting solenoid valve N.C.

PN 22 - PN 25. Normally closed. Indirect acting. Fluid temperature -10°C / + 140°C. Body Stainless steel AISI 316. Stainless steel control pilot. FKM membrane. Orifice stainless steel. Coil 8W.

Recambios

- Conjunto tubo guía - E025
- Conjunto núcleo móvil - E020V
- Membrana 3/8"-1/2" - E052V
- Membrana 3/4"-1" - E053V

Spare parts

- Conductor pipe set - E025
- Plunger set - E020V
- Membrane 3/8"-1/2" - E052V
- Membrane 3/4"-1" - E053V

CÓDIGO CODE	MEDIDA SIZE	PESO WEIGHT	CAJA / BOX CARTON	P.V.P. € PRICE €
4632 04	1/2"	0,570	1	-
4632 05	3/4"	1,220	1	-
4632 06	1"	1,110	1	-

E025	-	-	1	-
E020V	-	-	1	-
E052V	1/2"	-	1	-
E053V	3/4" - 1"	-	1	-

DN	PN	A mm.	B mm.	C mm.	Ø	Presiones / Pressure			Potencia / Power		Kv
						min.	max. M.O.P.D.		(watt)	l/min	
					mm	bar	AC bar	DC bar			
1/2"	25	40	103	73	12	0,1	20	20	8	35	
3/4"	22	65	115	104	19	0,1	16	16	8	130	
1"	22	65	115	104	25	0,1	16	16	8	160	

BOBINA	8 W
D (mm)	30
E (mm)	42
F (mm)	54

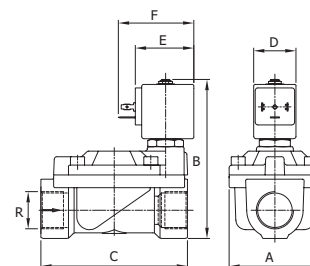

Ref. 4633

NEW

Electroválvula de acción indirecta 2 vías N.A.

PN 22 - PN 25. Normalmente abierta. Acción indirecta. Temperatura del fluido -10°C / +140°C. Cuerpo en Acero inoxidable AISI 316. Piloto mando Acero Inox. Membrana FKM. Asiento cierre Acero inox. Bobina 8W.

2 ways indirect acting solenoid valve N.O.

PN 22 - PN 25. Normally opened. Indirect acting. Fluid temperature -10°C / + 140°C. Body Stainless steel AISI 316. Stainless steel control pilot. FKM membrane. Orifice stainless steel. Coil 8W.

4633 04	1/2"	0,570	-	-
4633 05	3/4"	1,220	-	-
4633 06	1"	1,110	-	-

*Bajo demanda / On request

DN	PN	A mm.	B mm.	C mm.	Ø	Presiones / Pressure			Potencia / Power		Kv
						min.	max. M.O.P.D.		(watt)	l/min	
					mm	bar	AC bar	DC bar			
1/2"	25	40	103	73	12	0,1	20	20	8	35	
3/4"	22	65	115	104	19	0,1	16	16	8	130	
1"	22	65	115	104	25	0,1	16	16	8	160	

BOBINA	8 W
D (mm)	30
E (mm)	42
F (mm)	54

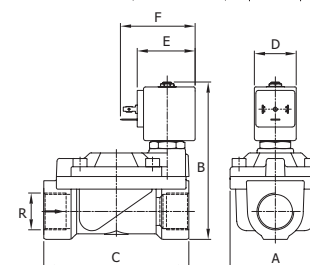
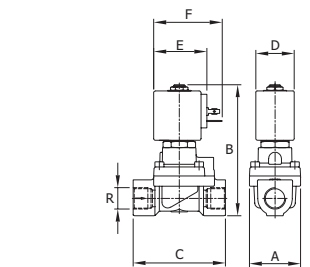

CÓDIGO MEDIDA PESO CAJA / BOX P.V.P. €
CODE SIZE WEIGHT CARTON PRICE €

Ref. 4635

NEW

Electroválvula de acción mixta 2 vías N.C.
PN 16. Normalmente cerrada. Acción mixta. Temperatura del fluido -10°C / +90°C. Cuerpo en Acero inoxidable AISI 316. Piloto mando Acero Inox. Membrana de NBR+PA. Bobina de 8W para medidas 3/8" a 3/4". Bobina de 14W para medida de 1".

2 ways mixed acting solenoid valve N.C.
PN 16. Normally closed. Mixed acting. Fluid temperature -10°C / +90°C. Body Stainless steel AISI 316. Stainless steel control pilot. NBR+PA membrane. 8W coil for sizes from 3/8" to 3/4". 14W coil for size of 1".



DN	PN	A mm.	B mm.	C mm.	Ø	Presiones / Pressure				Potencia / Power (watt)	Kv
						min.	max. M.O.P.D.	AC bar	DC bar		
3/8"	16	50	89	56	15	0	14	6	8	40	
1/2"	16	50	100	70	16	0	14	6	8	50	
3/4"	16	50	100	70	20	0	14	6	8	60	
1"	16	65	112	104	25	0	14	14	14	140	

BOBINA	8 W	14 W
D (mm)	30	52
E (mm)	42	55
F (mm)	54	67

4635 03	3/8"	0,450	-	-
4635 04	1/2"	0,740	-	-
4635 05	3/4"	0,600	-	-
4635 06	1"	1,050	-	-

*Bajo demanda / On request

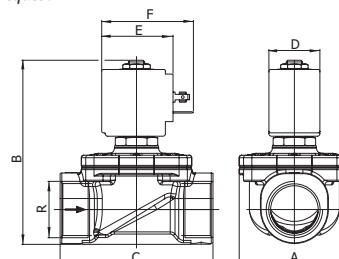

Ref. 4110

Electroválvula para gas
Normalmente cerrada. Cuerpo aluminio. Cierres NBR. Presión máxima 1 bar. Conforme a Directiva 2014/34/CE ATEX y a Directiva Gas 2009/142/CEE.

Gas solenoid valve
Normally closed. Aluminium body. NBR sealings. Maximum pressure 1 bar. Following Directive 2014/34/CE ATEX and Gas Directive 2009/142/CEE.



Medida/Size	A mm	B mm	C mm
1/2"	70	135	74
3/4"	70	135	74
1"	70	135	74
1 1/4"	160	213	140
1 1/2"	160	213	140
2"	160	213	140

4110 04	1/2"	0,000	1	-
4110 05	3/4"	0,000	1	-
4110 06	1"	0,000	1	-
4110 07	1 1/4"	0,000	1	-
4110 08	1 1/2"	0,000	1	-
4110 09	2"	0,000	1	-

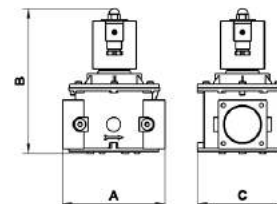

Ref. 4112

Electroválvula para gas
Normalmente cerrada. Cuerpo aluminio. Cierres NBR. Presión máxima 200 mbar. Conforme a Directiva 2014/34/CE ATEX y a Directiva Gas 2009/142/CEE.

Gas solenoid valve
Normally closed. Aluminium body. NBR sealings. Maximum pressure 200 mbar. Following Directive 2014/34/CE ATEX and Gas Directive 2009/142/CEE.



Medida/Size	A mm	B mm	C mm
1/2"	70	136	74
3/4"	70	136	74
1"	70	136	74
1 1/4"	160	187	140
1 1/2"	160	187	140
2"	160	213	140

4112 04	1/2"	0,000	1	-
4112 05	3/4"	0,000	1	-
4112 06	1"	0,000	1	-
4112 07	1 1/4"	0,000	1	-
4112 08	1 1/2"	0,000	1	-
4112 09	2"	0,000	1	-

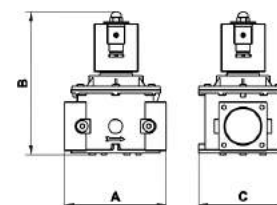

Ref. 4115

Electroválvula con rearme manual para gas
Normalmente cerrada. Cuerpo aluminio. Cierres NBR. Presión máxima 500 mbar. Conforme a Directiva 2014/34/CE ATEX y a Directiva Gas 2009/142/CEE.

Gas manual reset solenoid valve
Normally closed. Aluminium body. NBR sealings. Maximum pressure 500 mbar. Following Directive 2014/34/CE ATEX and Gas Directive 2009/142/CEE.



Medida/Size	A mm	B mm	C mm
1/2"	70	163	74
3/4"	70	163	74
1"	70	163	74

4115 04	1/2"	0,000	1	-
4115 05	3/4"	0,000	1	-
4115 06	1"	0,000	1	-

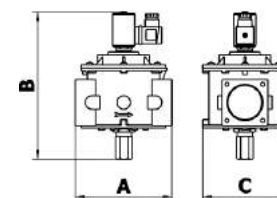

Ref. 4118



Electroválvula con rearme manual para gas

Normalmente abierta. Cuerpo aluminio. Cierres NBR. Presión máxima 500 mbar. Conforme a Directiva 2014/34/CE ATEX y a Directiva Gas 2009/142/CEE.

Gas manual reset solenoid valve

Normally opened. Aluminium body. NBR sealings. Maximum pressure 500 mbar. Following Directive 2014/34/CE ATEX and Gas Directive 2009/142/CEE.

Medida/Size	A mm	B mm	C mm
1/2"	70	111	74
3/4"	70	111	74
1"	70	111	74

CÓDIGO CODE	MEDIDA SIZE	PESO WEIGHT	CAJA / BOX CARTON	P.V.P. € PRICE €
4118 04	1/2"	0,000	1	-
4118 05	3/4"	0,000	1	-
4118 06	1"	0,000	1	-

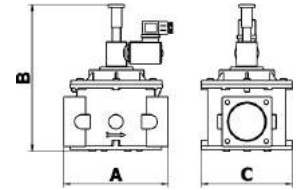

Ref. 4120



Electroválvula con rearme manual para gas

Normalmente cerrada. Cuerpo latón UNE-EN 12164. Cierres NBR. Presión máxima 500 mbar. Conforme a Directiva 2014/34/CE ATEX y a Directiva Gas 2009/142/CEE.

Gas manual reset solenoid valve

Normally closed. Brass body UNE-EN 12164. NBR sealings. Maximum pressure 500 mbar. Following Directive 2014/34/CE ATEX and Gas Directive 2009/142/CEE.

Medida/Size	A mm	B mm
1/2"	66	133
3/4"	66	133
1"	82	142

4120 04	1/2"	0,000	1	-
4120 05	3/4"	0,000	1	-
4120 06	1"	0,000	1	-

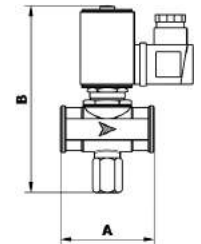

Ref. 4122



Electroválvula con rearme manual para gas

Normalmente abierta. Cuerpo latón UNE-EN 12164. Cierres NBR. Presión máxima 500 mbar. Conforme a Directiva 2014/34/CE ATEX y a Directiva Gas 2009/142/CEE.

Gas manual reset solenoid valve

Normally opened. Brass body UNE-EN 12164. NBR sealings. Maximum pressure 500 mbar. Following Directive 2014/34/CE ATEX and Gas Directive 2009/142/CEE.

Medida/Size	A mm	B mm	C mm
1/2"	66	107	34
3/4"	66	107	34
1"	82	118	44

4122 04	1/2"	0,000	1	-
4122 05	3/4"	0,000	1	-
4122 06	1"	0,000	1	-

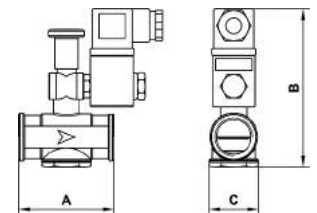

CÓDIGO MEDIDA PESO CAJA / BOX P.V.P. €
CODE SIZE WEIGHT CARTON PRICE €

Ref. 4710 - 4711

Válvula hidráulica manual 2 vías N.C. (4710)

PN 10. Normalmente cerrada. Temperatura del fluido +5°C / +50°C. Cuerpo en hierro G-25. Hidromembrana NR reforzada con nylon. Extremos rosca gas. Con pintura epoxy.

2 ways Manual hydraulic valve N.C. (4710)

PN 10. Normally closed. Fluid temperature +5°C / +50°C. Body in iron G-25. Hydro-membrane reinforced with nylon. Gas threaded ends. With epoxy paint.

(4711)

Mismas características que la anterior pero con extremos con bridas ISO-5752-15.

Same characteristics as above but with flanged ends ISO-5752-15.

4710 09	2"	3,500	1-1	-
4710 11	3"	8,000	1-1	-

4711 11	Ø 80	18,500	1-1	-
4711 12	Ø 100	20,500	1-1	-
4711 14	Ø 150	46,000	1-1	-
4711 16	Ø 200	50,000	1-1	-
4711 18	Ø 250	90,000	1-1	-

DN	PN	L mm.	H mm.	E mm.	Ø		Presiones / Pressure		Kv
					mm		min.	max.	
2"	10	175	100	120	50		1,5	10	100
3"	10	230	135	165	80		1,5	10	160
80	10	280	200	210	80		1,7	10	180
100	10	300	220	220	100		1,7	10	220
150	10	350	320	320	150		1,4	10	410
200	10	400	340	340	200		1,4	10	480
250	10	450	470	405	250		1,4	10	780

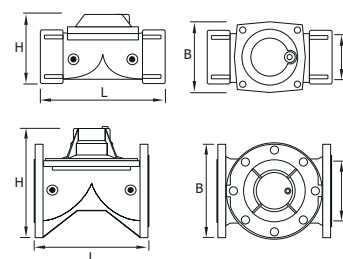

Ref. 4720 - 4721

Válvula hidráulica con electroválvula 2 vías N.C. (4720)

PN 10. Normalmente cerrada. Acción Indirecta. Temperatura del fluido +5°C / +50°C. Cuerpo en hierro G-25. Hidromembrana NR reforzada con nylon. Extremos rosca gas. Con pintura epoxy. Normalmente abierta a petición ref. 4722.

Hydraulic valve with solenoid valve (4720)

PN 10. Normally closed. Indirect acting. Fluid temperature +5°C / +50°C. Body in iron G-25. Hydro-membrane reinforced with nylon. Gas threaded ends. With epoxy paint. Normally opened on request ref. 4722.

(4721)

Mismas características que la anterior pero con extremos con bridas ISO-5752-15.

Same characteristics as above but with flanged ends ISO-5752-15.

4720 09	2"	3,500	1	-
4720 11	3"	8,000	1	-

4721 11	Ø 80	18,500	1	-
4721 12	Ø 100	20,500	1	-
4721 14	Ø 150	46,000	1	-
4721 16	Ø 200	50,000	1	-
4721 18	Ø 250	90,000	1	-

DN	PN	L mm.	H mm.	E mm.	Ø		Presiones / Pressure		Kv
					mm		min.	max.	
2"	10	175	100	120	50		1,5	10	100
3"	10	230	135	165	80		1,5	10	160
80	10	280	200	210	80		1,7	10	180
100	10	300	220	220	100		1,7	10	220
150	10	350	320	320	150		1,4	10	410
200	10	400	340	340	200		1,4	10	480
250	10	450	470	405	250		1,4	10	780

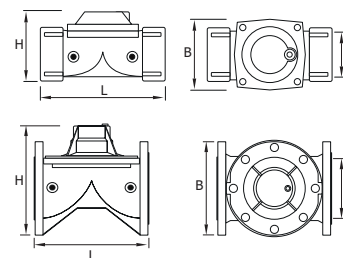

Ref. 4730 - 4731



Válvula hidráulica con flotador 2 vías N.C. (4730)
 PN 10. Normalmente cerrada. Temperatura del fluido +5°C / +50°C. Cuerpo en hierro G-25. Hidromembrana NR reforzada con nylon. Extremos rosca gas. Con pintura epoxy.

2 ways floating hydraulic valve N.C. (4730)
 PN 10. Normally closed. Fluid temperature +5°C / +50°C. Body in iron G-25. Hydro-membrane reinforced with nylon. Gas threaded ends. With epoxy paint.

(4731)
 Mismas características que la anterior pero con extremos con bridas ISO-5752-15.
 Same characteristics as above but with flanged ends ISO-5752-15.

DN	PN	L mm.	H mm.	E mm.	Ø	Presiones / Pressure		Kv
						mm	min.	
2"	10	175	100	120	50	1,5	10	100
3"	10	230	135	165	80	1,5	10	160
80	10	280	200	210	80	1,7	10	180
100	10	300	220	220	100	1,7	10	220
150	10	350	320	320	150	1,4	10	410
200	10	400	340	340	200	1,4	10	480
250	10	450	470	405	250	1,4	10	780

CÓDIGO CODE	MEDIDA SIZE	PESO WEIGHT	CAJA / BOX CARTON	P.V.P. € PRICE €
-------------	-------------	-------------	-------------------	------------------

4730 09	2"	3,500	1-1	-
4730 11	3"	8,000	1-1	-

4731 11	Ø 80	18,500	1-1	-
4731 12	Ø 100	20,500	1-1	-
4731 14	Ø 150	46,000	1-1	-
4731 16	Ø 200	50,000	1-1	-
4731 18	Ø 250	90,000	1-1	-

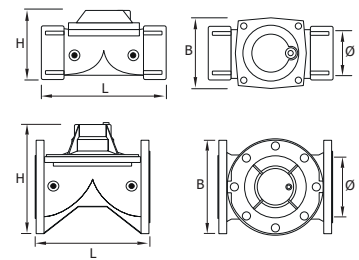

Ref. 4805



Bobina 5W Clase F (155°C)
 Potencia 5W. Tolerancia de tensión en corriente alterna (+10% - 15%) y en corriente continua (+10% - 5%). Voltajes disponibles en corriente alterna 24V - 48V - 110V - 220V (50-60 Hz) y en corriente continua 12V - 24V. Temperatura máxima 155°C. Grado de protección IP65.

Class F 5W Coil (155°C)
 5W power. Voltage tolerance in alternating current (10% - 15%) and in direct current (+10% - 5%). Available voltages in alternating current 24V - 48V - 110V - 220V (50-60 Hz) and in direct current 12V - 24V. Maxim Temperature 155°C. IP65 degree protection.

4805	-	0,060	1-1	-
------	---	-------	-----	---

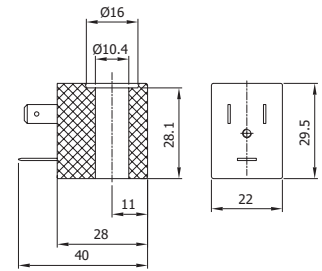

Ref. 4808 - 4974



(4808) Bobina 8W Clase F (155°C)
 Potencia 8W. Tolerancia de tensión en corriente alterna (+10% - 15%) y en corriente continua (+10% - 5%). Voltajes disponibles en corriente alterna 24V - 48V - 110V - 220V (50-60 Hz) y en corriente continua 12V - 24V. Temperatura máxima 155°C. Grado de protección IP65.

(4808) Class F 8W Coil (155°C)
 8W power. Voltage tolerance in alternating current (10% - 15%) and in direct current (+10% - 5%). Available voltages in alternating current 24V - 48V - 110V - 220V (50-60 Hz) and in direct current 12V - 24V. Maxim Temperature 155°C. IP65 degree protection.

(4974) Bobina 8W Clase F (155°C) con cables saliente
 Potencia 8W. Con cable saliente. Tolerancia de tensión en corriente alterna (+10% - 15%) y en corriente continua (+10% - 5%). Voltajes disponibles en corriente alterna 220V (50-60 Hz). Temperatura máxima 155°C. Grado de protección IP65.

(4974) Class F 8W Coil (155°C) with external wire
 8W power. External wire. Voltage tolerance in alternating current (10% - 15%) and in direct current (+10% - 5%). Available voltages in alternating current 220V (50-60 Hz). Maxim Temperature 155°C. IP65 degree protection.

4808	-	0,130	1-100	-
------	---	-------	-------	---

4974	-	-	-	-
------	---	---	---	---

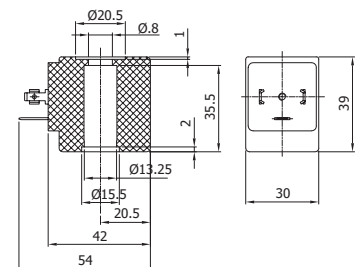

CÓDIGO CODE	MEDIDA SIZE	PESO WEIGHT	CAJA / BOX CARTON	P.V.P. € PRICE €
----------------	----------------	----------------	----------------------	---------------------

Ref. 4828

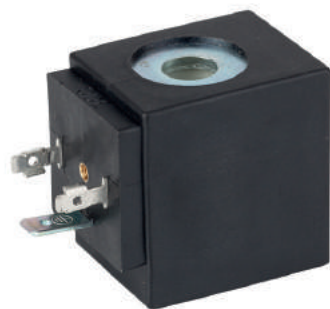

Bobina 8W Clase H (180°C)

Potencia 8W. Tolerancia de tensión en corriente alterna (+10% - 15%) y en corriente continua (+10% - 5%). Voltajes disponibles en corriente alterna 24V - 48V - 110V - 220V (50-60 Hz) y en corriente continua 12V - 24V. Temperatura máxima 180°C. Grado de protección IP65.

Class H 8W Coil (180°C)

8W power. Voltage tolerance in alternating current (10% - 15%) and in direct current (+10% - 5%). Available voltages in alternating current 24V - 48V - 110V - 220V (50-60 Hz) and in direct current 12V - 24V. Maxim Temperature 180°C. IP65 degree protection.

4828	-	0,2	-	-
------	---	-----	---	---

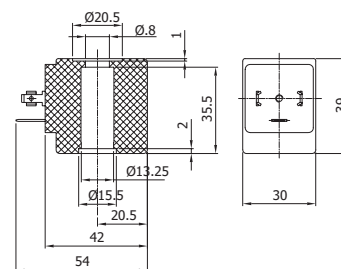

Ref. 4814



Bobina 14W Clase H (180°C)

Potencia 14W. Tolerancia de tensión en corriente alterna (+10% - 15%) y en corriente continua (+10% - 5%). Voltajes disponibles en corriente alterna 24V - 48V - 110V - 220V (50-60 Hz) y en corriente continua 12V - 24V. Temperatura máxima 180°C. Grado de protección IP65.

Class H 14W Coil (180°C)

14W power. Voltage tolerance in alternating current (10% - 15%) and in direct current (+10% - 5%). Available voltages in alternating current 24V - 48V - 110V - 220V (50-60 Hz) and in direct current 12V - 24V. Maxim Temperature 180°C. IP65 degree protection.

4814	-	0,385	1-50	-
------	---	-------	------	---

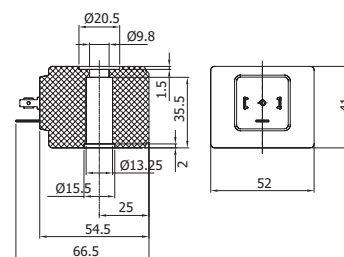

Ref. 4819



Bobina para electroválvulas 5 vías

Tolerancia de tensión
C.A. +10% - 15%
C.C. +10% - 5%
Voltajes C.A.: 24-48-110-220 50/60 Hz
C.C.: 12-24

5 W solenoid valve coil

Power tolerance
A.C. +10% - 15%
D.C. +10% - 5%
Voltages A.C.: 24-48-110-220 50/60 Hz
C.C.: 12-24

4819	-	0,054	1-100	-
------	---	-------	-------	---

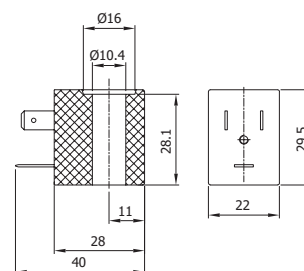

Ref. 4801 - 4804



Conector tripolar 5W

Conector de 3 polos. Potencia 5W. DIN 43650. Grado de protección IP65.

3-Pole 5W connector

3-Pole connector. 5W power. DIN 43650. IP65 degree protection.

(4804) Conector tripolar 5W con señal luminosa

Conector de 3 polos. Potencia 5W. Con señal luminosa LED. DIN 43650. Grado de protección IP65. Ref. 4804 220V para voltajes Corriente Alterna. Ref. 4804 C24V para voltajes Corriente Continua.

(4804) 3-Pole 5W connector with luminous signal

3-Pole connector. 5W power. With LED luminous signal. DIN 43650. IP65 degree protection. Ref. 4804 220V for AC voltages. Ref. 4804 C24V for DC voltages.

4801 05	-	0,020	25-350	-
---------	---	-------	--------	---

4804 220V	-	-	-	-
4804 C24V	-	-	-	-

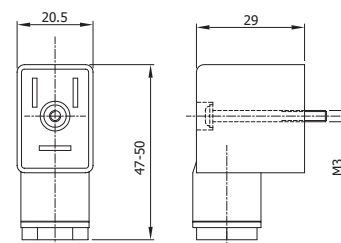

Ref. 4801 - 4803



Conector tripolar 8W

Conector de 3 polos. Potencia 8W. DIN 43650. Grado de protección IP65.

3-Pole 8W connector

3-Pole connector. 8W power. DIN 43650. IP65 degree protection.

(4803) Conector tripolar 8W con señal luminosa

Conector de 3 polos. Potencia 8W. Con señal luminosa LED. DIN 43650. Grado de protección IP65.

Ref. 4803 A24V para voltajes Corriente Alterna. Ref. 4803 C24V para voltajes Corriente Continua.

(4803) 3-Pole 8W connector with luminous signal

3-Pole connector. 8W power. With LED luminous signal. DIN 43650. IP65 degree protection.

Ref. 4803 A24V for AC voltages. Ref. 4803 C24V for DC voltages.

CÓDIGO CODE	MEDIDA SIZE	PESO WEIGHT	CAJA / BOX CARTON	P.V.P. € PRICE €
-------------	-------------	-------------	-------------------	------------------

4801 08	-	0,022	25-350	-
---------	---	-------	--------	---

4803 A24V	-	-	-	-
4803 C24V	-	-	-	-

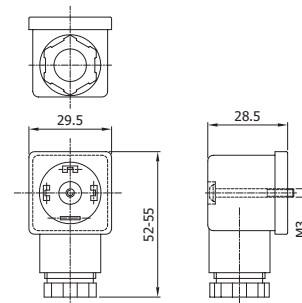

Ref. K4000



Kit antihumedad

Aplicable para válvulas de 2 vías. Grado de protección IP67.

Kit against humidity

Aplicable for 2 ways valves. IP67 Protection degree.

K4000	-	0,001	1-1	-
-------	---	-------	-----	---

Precios a consultar / Prices on request

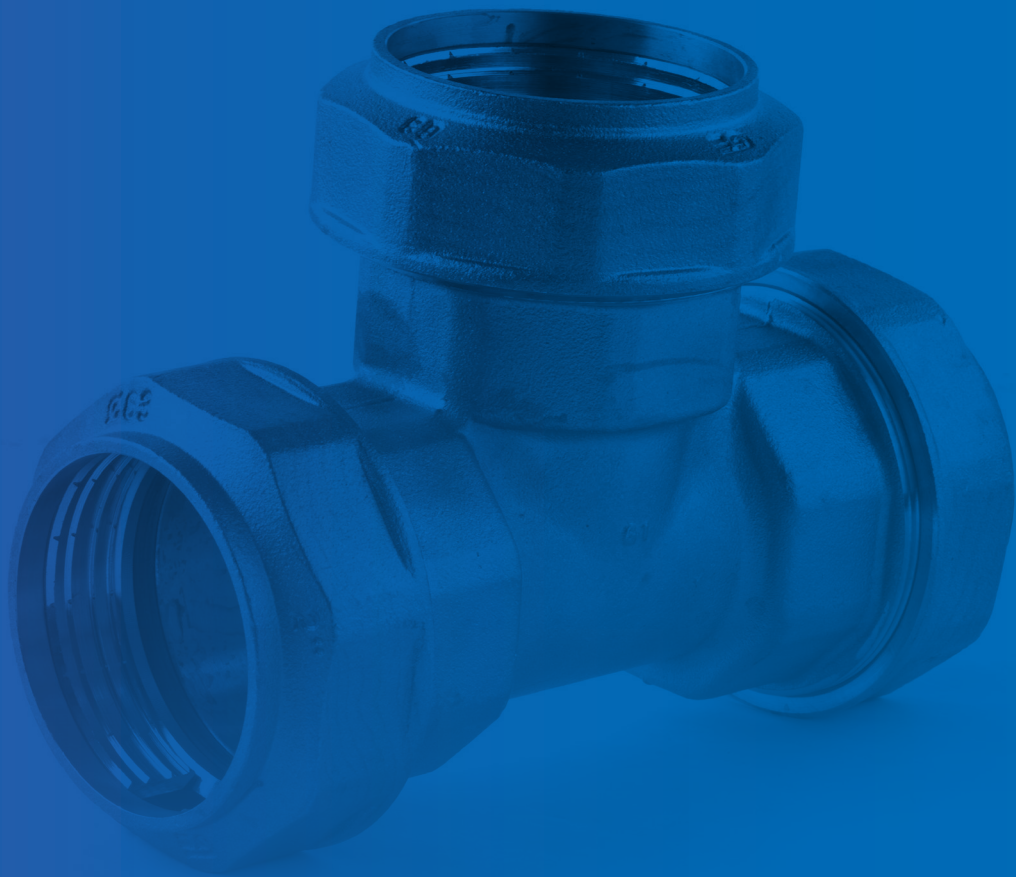



ACCESORIOS LATÓN

BRASS ACCESORIES

Rácores de latón forjado sistema RAC-GE para la unión hermética de tuberías de plástico. El Sistema de apriete RAC-GE garantiza una máxima seguridad y fiabilidad para la conexión de tubos en instalaciones hidrosanitarias y de calefacción.

Forged brass fittings with the RAC-GE system for a sealed joining of plastic pipes. The fittings new external structure makes the installation much easier and provides maximum security and reliability for the connection of pipes in hydrosanitary and heating installations.

ACCESORIOS LATÓN BRASS ACCESSORIES

SISTEMA DE APRIETE RAC-GE "RAC-GE" AIR TIGHT SYSTEM

La particularidad principal de este sistema radica en el anillo de apriete. El anillo está fabricado en latón especial con la elasticidad necesaria para el montaje y desmontaje del accesorio. Su geometría simétrica permite ser montado en cualquier posición.

El sistema de fijación es "por puntos" lo que evita la rotura del tubo y ofrece una mayor adaptabilidad a las posibles ovalaciones y/o imperfecciones del tubo.

No es necesario desmontar el accesorio para su instalación.

Particularmente adaptable para la unión de tubos de polietileno de baja y alta densidad.

The special feature of this system lies in the fastening necking. The necking is made out of a special type of brass with the required elasticity for assembling and disassembling the fitting. Its symmetrical shape enables it be mounted in any position.

The locking system is "by points", which prevents the cutting of the pipe and offers a better adaptation to the possible ovalizations and/or imperfections of the pipe.

It is not necessary to disassemble the fitting to install it.

Specially adaptable for connecting low and high density polyethylene pipes.



INSTRUCCIONES DE MONTAJE

Estas indicaciones evitan que cualquier tipo de deformación en el tubo impida su acoplamiento. En la figura se ilustra un ejemplo de ensamblaje del conjunto.

ASSEMBLING INSTRUCTIONS

These instructions avoid any deformation of the pipe which could prevent its correct assembling. In the figure below there is an exemple illustration of the assembling process.

1. Tapa Nut
2. Anillo apriete Necking
3. Anillo tope Washer ring
4. Tórica O'ring
5. Cuerpo Connector

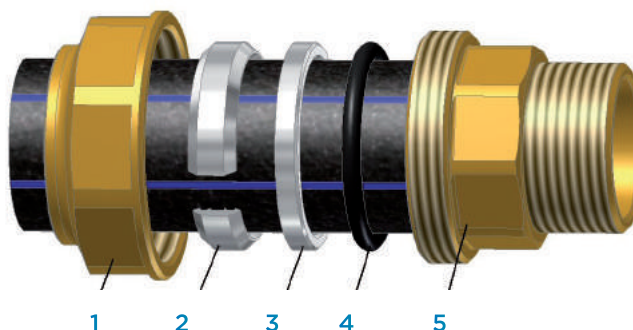

- A Desmontar la tuerca (1) del cuerpo del racor (5) e insertarla en el tubo.
- B Introducir en el tubo el anillo de apriete (2).
- C Introducir en el tubo el anillo tope (3) con la cara plana en dirección al o'ring.
- D Introducir en el tubo la junta tórica (4).
- E Situar el tubo con todos los componentes en el cuerpo del racor (5) hasta que haga tope.
- F Apretar la tuerca (1) en el cuerpo del racor (5).

- A Disassemble the nut (1) from the connector (5) and insert it into the pipe.
- B Insert the necking (2) into the pipe.
- C Insert the washer ring (3) into the pipe with the flat face in direction to the o'ring.
- D Insert the O'ring (4) into the pipe.
- E Place the pipe with all the components inside the body of the connector (5) until the pipe is fixed.
- F Tighten the nut (1) to the body of the connector (5).

Ref. 0012



Racor recto hembra

PN-16 - paso total. Construcción en latón forjado s/UNE-EN 12165. Extremo roscado gas hembra s/ISO 228/1. Conexión a tubería mediante sistema de apriete diseño Genebre "RAC-GE". Temp. de trabajo de -10°C a +90°C. Aplicable para la unión de tubo de polietileno de baja, media y alta densidad.

Straight female connector

PN 16 full bore. Forged brass UNE-EN 12165 Female gas threaded ends ISO 228/1. Genebre's designed "RAC-GE" air tight system for connection to pipe. Working temp.: -10 °C to 90 °C. Applicable for the connection of low, medium and high density polyethylene pipe.

	P	Ø D	A
1/2" x PE20	16,5	34	38
3/4" x PE25	22,5	41	44
1" x PE32	28,5	50	51
1 1/4" x PE40	36	60	60
1 1/2" x PE50	45	72	70
2" x PE63	55	88	83

CÓDIGO CODE	MEDIDA SIZE	PESO WEIGHT	CAJA / BOX CARTON	P.V.P. € PRICE €
0012 04	1/2" x 20	0,070	20-280	-
0012 05	3/4" x 25	0,107	15-210	-
0012 06	1" x 32	0,191	12-108	-
0012 07	1 1/4" x 40	0,270	6-54	-
0012 08	1 1/2" x 50	0,420	4-36	-
0012 09	2" x 63	0,730	2-24	-

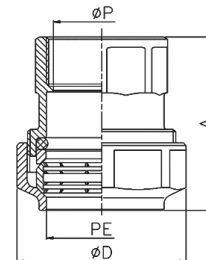

Ref. 0012



Racor recto hembra con bridas

Características de racor recto hembra. Tornillo fijación: inox M10 DIN 933-8.8. Arandela dentada: inox J10,5 DIN 6798.

Straight female connector with flanges

Same characteristics than straight female connector. Fastening screw: inox M10 DIN 933-8.8. Serrated washer: inox J10,5. DIN 6798.

	P	Ø D	Ø d	A
2 1/2" x 75	65	132	76,5	93
3" x 90	80	150	92	105
4" x 110	100	176	112	123

0012 10	2 1/2" x 75	1,331	4-16	-
0012 11	3" x 90	1,900	2-12	-
0012 12	4" x 110	3,256	2-8	-

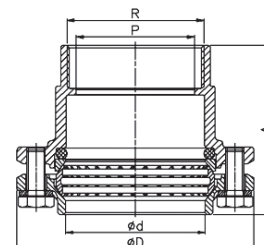

Ref. 0017

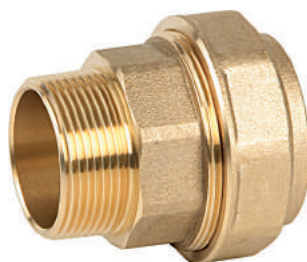

Racor recto macho

PN-16 - paso total. Construcción en latón forjado s/UNE-EN 12165. Extremo roscado gas macho s/ISO 7/1. Conexión a tubería mediante sistema de apriete diseño Genebre "RAC-GE". Temperatura de trabajo de -10°C a 90°C. Aplicable para la unión de tubo de polietileno de baja, media y alta densidad.

Straight male connector

PN 16 full bore. Forged brass UNE-EN 12165. Male gas threaded ends ISO 7/1. Genebre's designed "RAC-GE" air tight system for connection to pipe. Working temp.: -10 °C to 90 °C. Applicable for the connection of low, medium and high density polyethylene pipe.

	P	Ø D	A
1/2" x PE20	15	34	39
3/4" x PE25	20	41	45
1" x PE32	26	50	53
1 1/4" x PE40	34,5	60	65
1 1/2" x PE50	40	72	73
2" x PE63	51	88	89

0017 04	1/2" x 20	0,069	20-360	-
0017 05	3/4" x 25	0,106	15-210	-
0017 06	1" x 32	0,192	12-108	-
0017 07	1 1/4" x 40	0,295	6-54	-
0017 08	1 1/2" x 50	0,395	4-36	-
0017 09	2" x 63	0,766	2-24	-

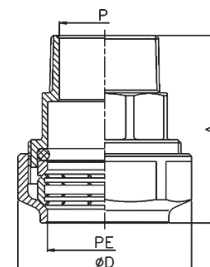

Ref. 0017



Racor recto macho con bridas

Características de racor recto macho. Tornillo fijación: inox M10 DIN 933-8.8. Arandela dentada: inox J10,5 DIN 6798.

Straight male connector with flanges

Same characteristics than straight male connector. Fastening screw: inox M10 DIN 933-8.8. Serrated washer: inox J10,5 DIN 6798.

	P	Ø D	Ø d	A
2 1/2" x 75	65	132	75	93
3" x 90	80	150	90	105
4" x 110	100	176	110	123

0017 10	2 1/2" x 75	1,340	4-16	-
0017 11	3" x 90	1,850	2-12	-
0017 12	4" x 110	3,100	2-8	-

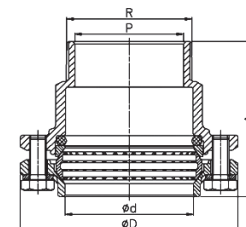

Ref. 0022



Racor acoplamiento recto

PN-16 - paso total. Construcción en latón forjado s/UNE-EN 12165. Conexión a tubería mediante sistema de apriete diseño Genebre "RAC-GE". Temperatura de trabajo de -10°C a +90°C. Aplicable para la unión de tubo de polietileno de baja, media y alta densidad.

Straight double coupling connector

PN 16 full bore. Forged brass UNE-EN 12165. Genebre's designed "RAC-GE" air tight system for connection to pipe. Working temp.: -10°C to 90 °C. Applicable for the connection of low, medium and high density polyethylene pipe.

	P	ØD	A
PE20 x PE20	16,5	34	50
PE25 x PE25	22,5	41	59
PE32 x PE32	28,5	50	71
PE40 x PE40	36	60	86
PE50 x PE50	45	72	100
PE63 x PE63	55	88	125

CÓDIGO CODE	MEDIDA SIZE	PESO WEIGHT	CAJA / BOX CARTON	P.V.P. € PRICE €
0022 04	20 x 20	0,105	12-216	-
0022 05	25 x 25	0,160	12-132	-
0022 06	32 x 32	0,240	8-64	-
0022 07	40 x 40	0,410	4-36	-
0022 08	50 x 50	0,620	2-28	-
0022 09	63 x 63	1,075	2-12	-

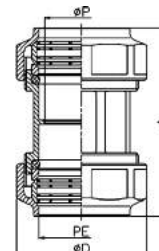

Ref. 0022



Racor acoplamiento recto con bridas

Características de racor acoplamiento recto. Tornillo fijación: inox M10 DIN 933-8.8. Arandela dentada: inox J10,5 DIN 6798.

Straight double coupling connector with flanges

Same characteristics than straight double coupling connector. Fastening screw: inox M10 DIN 933-8.8. Serrated washer: inox J10,5 DIN 6798.

	P	ØD	Ød	A
75 x 75	65	132	75	134
90 x 90	80	150	90	155
110 x 110	100	176	110	185

0022 10	75 x 75	2,168	4-8	-
0022 11	90 x 90	3,149	2-6	-
0022 12	110 x 110	5,384	1-4	-

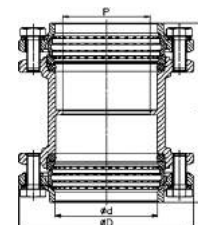

Ref. 0022R

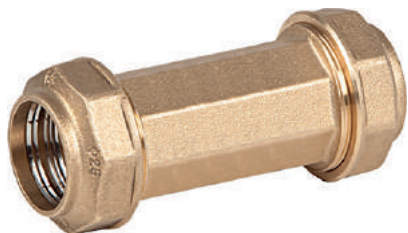

Racor acoplamiento recto para reparación

PN16. Paso total. Construcción en latón forjado s/UNE-EN 12165. Conexión a tubería mediante sistema de apriete diseño Genebre "RAC-GE". Temperatura de trabajo de -10°C a +90°C. Aplicable para la unión de tubo de polietileno de baja, media y alta densidad.

Straight double coupling connector for repair works

PN16. Full bore. Forged brass UNE-EN 12165. Genebre's design "RAC-GE" tight system for connection to pipe. Working temp. -10°C to 90°C. Applicable for the connection of low, medium and high density polyethylene pipe.

	P	ØD	A
PE20 x PE20	21	34	90
PE25 x PE25	26	41	100
PE32 x PE32	32	50	115
PE40 x PE40	41	60	125
PE50 x PE50	51	72	140
PE63 x PE63	64	88	163

0022R 04	20 x 20	0,105	12-216	-
0022R 05	25 x 25	0,227	12-132	-
0022R 06	32 x 32	0,240	8-64	-
0022R 07	40 x 40	0,410	4-36	-
0022R 08	50 x 50	0,620	2-28	-
0022R 09	63 x 63	1,075	2-12	-

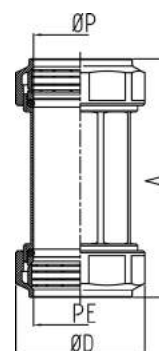

Ref. 0032



Racor "T" triple acoplamiento

PN-16 - paso total. Construcción en latón forjado s/UNE-EN 12165. Conexión a tubería mediante sistema de apriete diseño Genebre "RAC-GE". Temperatura de trabajo de -10°C a +90°C. Aplicable para la unión de tubo de polietileno de baja, media y alta densidad.

"T" triple coupling connector

PN 16 full bore. Body and nut: forged brass UNE-EN 12165. Genebre's designed "RAC-GE" air tight system for connection to pipe. Working temp: -10 °C to 90°C. Applicable for the connection of low, medium and high density polyethylene pipe.

	P	ØD	A	L
PE20 x PE20	14	34	37	74
PE25 x PE25	19	41	43	87
PE32 x PE32	24	50	53	106
PE40 x PE40	30,5	60	64	129
PE50 x PE50	38	72	77	154
PE63 x PE63	47,5	88	96	192

0032 04	20 x 20	0,160	6-84	-
0032 05	25 x 25	0,290	6-54	-
0032 06	32 x 32	0,430	4-28	-
0032 07	40 x 40	0,740	4-24	-
0032 08	50 x 50	1,275	2-12	-
0032 09	63 x 63	2,102	1-6	-

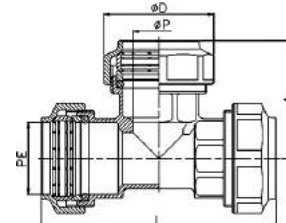

Ref. 0032



Racor "T" triple acoplamiento con bridas

Características racor "T" triple acoplamiento. Tornillo fijación: inox M10 DIN 933-8.8. Arandela dentada: inox J10,5 DIN 6798.

"T" triple coupling connector with flanges
Same characteristics than "T" triple coupling connector. Fastening screw: inox M10 DIN 933-8.8. Serrated washer: inox J10,5 DIN 6798.

	P	Ø D	L	A	Ø d
75 x 75	65	132	219	109	75
90 x 90	80	150	257	128	90

CÓDIGO CODE	MEDIDA SIZE	PESO WEIGHT	CAJA / BOX CARTON	P.V.P. € PRICE €
-------------	-------------	-------------	-------------------	------------------

0032 10	75 x 75	3,717	1-4	-
0032 11	90 x 90	5,518	1-3	-

Nota: El artículo 0032 12 (Ø 110) se obtiene a partir de los artículos 0037 12 + 0017 12.

Note: Item 0032 12 (Ø 110) is obtained through items 0037 12 + 0017 12.

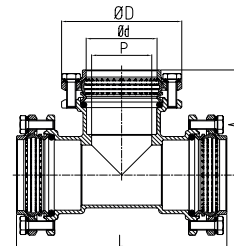

Ref. 0037



Racor "T" hembra

PN-16 - paso total. Construcción en latón forjado s/UNE-EN 12165. Extremo roscado gas hembra s/ISO 228/1. Conexión a tubería mediante sistema de apriete diseño Genebre "RAC-GE". Temperatura de trabajo de -10°C a +90°C. Aplicable para la unión de tubo de polietileno de baja, media y alta densidad.

"T" female connector
PN 16 full bore. Forged brass UNE-EN 12165. Female gas threaded ends ISO 228/1. Genebre's designed "RAC-GE" air tight system for connection to pipe. Working temp.: -10 °C to 90 °C. Applicable for the connection of low, medium and high density polyethylene pipe.

	P	Ø D	A	L
1/2" x PE20	14	34	23	74
3/4" x PE25	19	41	27,5	87
1" x PE32	24	50	32	106
1 1/4" x PE40	30,5	60	38	129
1 1/2" x PE50	38	72	45,5	154
2" x PE63	47,5	88	53,5	192

0037 04	1/2" x 20	0,143	8-112	-
0037 05	3/4" x 25	0,220	6-84	-
0037 06	1" x 32	0,369	4-36	-
0037 07	1 1/4" x 40	0,600	4-24	-
0037 08	1 1/2" x 50	0,960	2-14	-
0037 09	2" x 63	1,690	2-8	-

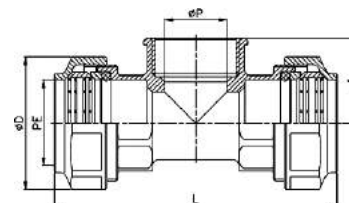

Ref. 0037



Racor "T" hembra con bridas

Características racor "T" hembra. Tornillo fijación: inox M10 DIN 933-8.8. Arandela dentada: inox J10, 5 DIN 6798.

"T" female connector with flanges
Same characteristics than "T". Female connector. Fastening screw: inox M10 DIN 933-8.8. Serrated washer: inox J10,5 DIN 6798.

	P	Ø D	L	A	Ø t/Ø p
2 1/2" x 75	65	132	202	75	75
3" x 90	80	150	239	82	90
4" x 90	100	176	279	98	110

0037 10	2 1/2" x 75	2,800	1-6	-
0037 11	3" x 90	4,183	1-3	-
0037 12	4" x 110	7,450	1-4	-

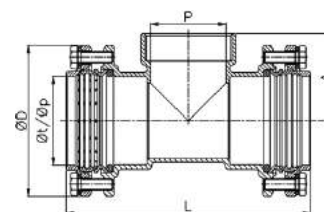

Ref. 0042



Racor "L" codo macho

PN-16 - paso total. Construcción en latón forjado s/UNE-EN 12165. Extremo roscado gas macho s/ISO 7/1. Conexión a tubería mediante sistema de apriete diseño Genebre "RAC-GE". Temperatura de trabajo de -10°C a +90°C. Aplicable para la unión de tubo de polietileno de baja, media y alta densidad.

"L" male elbow connector
PN 16 full bore. Forged brass UNE-EN 12165. Male gas threaded ends ISO 7/1. Genebre's designed "RAC-GE" air tight system for connection to pipe. Working temp.: -10 °C to 90 °C. Applicable for the connection of low, medium and high density polyethylene pipe.

	P	Ø D	L
1/2" x PE20	14	34	29,5
3/4" x PE25	19	41	35
1" x PE32	24	50	42,5
1 1/4" x PE40	30,5	60	51,5
1 1/2" x PE50	38	72	57,5
2" x PE63	47,5	88	69

0042 04	1/2" x 20	0,089	15-210	-
0042 05	3/4" x 25	0,139	12-108	-
0042 06	1" x 32	0,230	8-72	-
0042 07	1 1/4" x 40	0,400	6-36	-
0042 08	1 1/2" x 50	0,590	4-24	-
0042 09	2" x 63	1,002	2-12	-

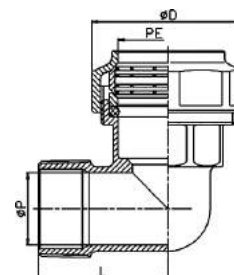

CÓDIGO MEDIDA PESO CAJA / BOX P.V.P. €
CODE SIZE WEIGHT CARTON PRICE €

Ref. 0042



Racor "L" codo macho con bridas

Características racor "L" codo macho. Tornillo fijación: inox M10 DIN 933-8.8. Arandela dentada: inox J10, 5 DIN 6798.

"L" male elbow connector with flanges

Same characteristics than "L" male elbow connector. Fastening screw: inox M10 DIN 933-8.8. Serrated washer: inox J10,5 DIN 6798.

	P	Ø D	L	Ø t/Ø p
2 1/2" x 75	65	132	94	75
3" x 90	80	150	104	90

0042 10	2 1/2" x 75	1,819	1-6	-
0042 11	3" x 90	2,850	1-8	-

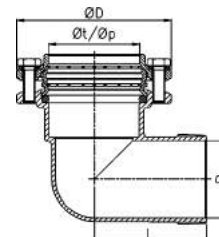

Ref. 0047



Racor "L" codo hembra

PN-16 - paso total. Construcción en latón forjado s/UNE-EN 12165. Extremo roscado gas macho s/ISO 7/1. Conexión a tubería mediante sistema de apriete diseño Genebre "RAC-GE". Temperatura de trabajo de -10°C a +90°C. Aplicable para la unión de tubo de polietileno de baja, media y alta densidad.

"L" female elbow connector

PN 16 - full bore. Forged brass UNE-EN 12165. Female gas threaded ends ISO 228/1. Genebre's designed "RAC-GE" air tight system for connection to pipe. Working temp.: -10 °C to 90 °C. Applicable for the connection of low, medium and high density polyethylene pipe.

	P	Ø D	L
1/2" x PE20	14	34	23
3/4" x PE25	19	41	27,5
1" x PE32	24	50	32
1 1/4" x PE40	30,5	60	38
1 1/2" x PE50	38	72	45,5
2" x PE63	47,5	88	53,5

0047 04	1/2" x 20	0,088	15-210	-
0047 05	3/4" x 25	0,141	10-90	-
0047 06	1" x 32	0,232	8-48	-
0047 07	1 1/4" x 40	0,380	6-36	-
0047 08	1 1/2" x 50	0,605	4-24	-
0047 09	2" x 63	1,055	2-12	-

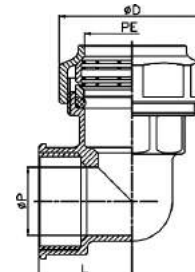

Ref. 0047



Racor "L" codo hembra con bridas

Características racor "L" codo hembra. Tornillo fijación: inox M10 DIN 933-8.8. Arandela dentada: inox J10, 5 DIN 6798.

"L" female elbow connector with flanges

Same characteristics than "L" female elbow connector. Fastening screw: inox M10 DIN 933-8.8. Serrated washer: inox J10,5 DIN 6798.

	P	Ø D	L	Ø t/Ø p
2 1/2" x 75	65	132	75	75
3" x 90	80	150	82	90
4" x 110	100	176	98	110

0047 10	2 1/2" x 75	1,757	1-6	-
0047 11	3" x 90	2,670	1-8	-
0047 12	4" x 110	4,668	1-4	-

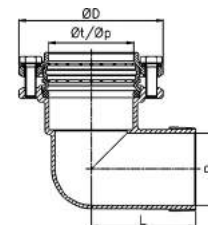

Ref. 0052



Racor "L" codo acoplamiento

PN-16 - paso total. Construcción en latón forjado s/UNE-EN 12165. Conexión a tubería mediante sistema de apriete diseño Genebre "RAC-GE". Temperatura de trabajo de -10°C a +90°C. Aplicable para la unión de tubo de polietileno de baja, media y alta densidad.

"L" elbow coupling connector

PN 16 - full bore. Forged brass UNE-EN 12165. Genebre's designed "RAC-GE" air tight system for connection to pipe. Working temp.: -10 °C to 90 °C. Applicable for the connection of low, medium and high density polyethylene pipe.

	P	Ø D	A
PE20 x PE20	14	34	37
PE25 x PE25	19	41	43
PE32 x PE32	24	50	53
PE40 x PE40	30,5	60	64
PE50 x PE50	38	72	77
PE63 x PE63	47,5	88	96

0052 04	20 x 20	0,193	12-108	-
0052 05	25 x 25	0,185	10-90	-
0052 06	32 x 32	0,329	6-42	-
0052 07	40 x 40	0,515	4-24	-
0052 08	50 x 50	0,800	2-18	-
0052 09	63 x 63	1,400	1-8	-

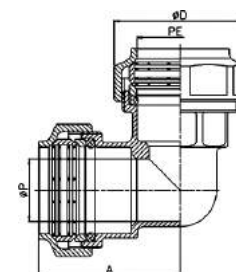

Ref. 0052



Racor "L" codo acoplamiento con bridas

Características racor "L" codo acoplamiento. Tornillo fijación: inox M10 DIN 933-8.8. Arandela dentada: inox J10, 5 DIN 6798.

"L" elbow coupling connector with flanges

Same characteristics than "L" elbow coupling connector. Fastening screw: inox M10 DIN 933-8.8. Serrated washer: inox J10, 5 DIN 6798.

	P	Ø D	L	Ø t/Ø p
75 x 75	65	132	115	75
90 x 90	80	150	128	90

CÓDIGO CODE	MEDIDA SIZE	PESO WEIGHT	CAJA / BOX CARTON	P.V.P. € PRICE €
-------------	-------------	-------------	-------------------	------------------

0052 10	75 x 75	2,609	1-6	-
0052 11	90 x 90	3,932	1-4	-

Nota: El artículo 0052 12 (Ø 110) se obtiene a partir de los artículos 0047 12 + 0017 12.

Note: Item 0052 12 (Ø 110) is obtained through items 0047 12 + 0017 12.

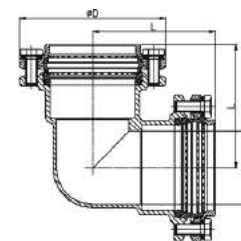

Ref. 0049



Racor "L" codo hembra con fijación a pared

PN-16 - paso total. Construcción en latón forjado s/UNE-EN 12165. Extremo roscado gas hembra s/ISO 228/1. Conexión a tubería mediante sistema de apriete diseño Genebre "RAC-GE". Temperatura de trabajo de -10°C a +90°C. Aplicable para la unión de tubo de polietileno de baja, media y alta densidad.

"L" female elbow connector with wall fixation

PN 16 full bore. Forged brass UNE-EN 12165. Female gas threaded ends ISO 228/1. Genebre's designed "RAC-GE" air tight system for connection to pipe. Working temp.: -10 °C to 90 °C. Applicable for the connection of low, medium and high density polyethylene pipe.

	P	Ø D	L	A
1/2" x PE20	14	34	23	45
3/4" x PE25	19	41	27,5	53,5
1" x PE32	24	50	32	62

0049 04	1/2" x 20	0,122	16-128	-
0049 05	3/4" x 25	0,186	14-84	-
0049 06	1" x 32	0,280	6-48	-

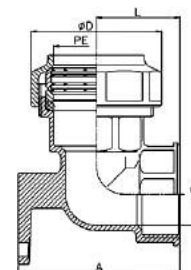

Ref. 3088



Válvula de esfera tubería PE

PN 25. Paso total. Construcción en latón s/UNE-EN 12165. Asientos PTFE. Extremos conexión a tubería mediante sistema de apriete diseño Genebre "RAC-GE". Temperatura de trabajo de -20°C a +110°C. Aplicable para la unión de tubo de polietileno de baja-media y alta densidad. Mando manual por palanca de acero.

Ball valve for PE pipe

PN 25. Full bore. Brass construction UNE-EN 12165. PTFE seats. Genebre's designed "RAC-GE" air tight system ends for connection to pipe. Working temp.: -20 °C to 110 °C. Applicable for the connection of low-medium and high density polyethylene pipe. Steel lever manual control.

DN	Ø PE	P	A	L	M
15	20	14	47	77	84
20	25	19	58	91	98
25	32	24	61	109	98

3088 04	20 x 20	0,240	6-108	-
3088 05	25 x 25	0,378	6-72	-
3088 06	32 x 32	0,574	3-36	-

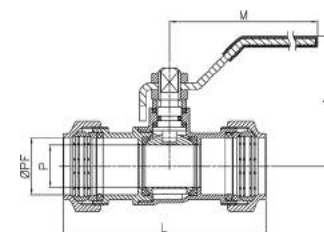

Ref. 3089



Válvula de esfera tubería PE

PN 25. Paso total. Construcción en latón s/UNE-EN 12165. Extremos roscado gas hembra s/ISO 228/1. Asiento PTFE. Conexión a tubería mediante sistema de apriete diseño Genebre "RAC-GE". Temperatura de trabajo de -20°C a + 110°C. Aplicable para la unión de tubo de polietileno de baja-media y alta densidad. Mando manual por palanca de acero.

Ball valve for PE pipe

PN 25. Full bore. Brass UNE-EN 12165. Female gas threaded ends ISO 228/1. PTFE Seats. Genebre's designed "RAC-GE" air tight system for connection to pipe. Working temp.: -20 °C to 110 °C. Applicable for the connection of low-medium and high density polyethylene pipe. Steel lever manual control.

DN	Ø PE	P	A	L	M
15	20	14	47	61	84
20	25	19	58	71	98
25	32	24	61	86	98

3089 04	1/2" x 20	0,195	8-144	-
3089 05	3/4" x 25	0,333	6-72	-
3089 06	1" x 32	0,497	4-48	-

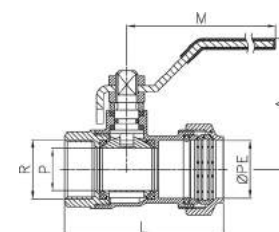

CÓDIGO MEDIDA PESO CAJA / BOX P.V.P. €
CODE SIZE WEIGHT CARTON PRICE €

Ref. 3124

NEW



Válvula de retención para tubería PE
PN 16. Construcción en latón forjado según UNE-EN 12165. Conexión a tubería mediante sistema de apriete diseño Genebre "RAC-GE". Temperatura de trabajo de -10°C a 90°C. Aplicable para la unión con tubo de polietileno en baja media y alta densidad. Cierre NBR vulcanizado. Muelle acero inox. AISI 304. Montaje en cualquier posición.

Check valve for PE pipe
PN 16. Forged brass according to UNE-EN 12165. Genebre's designed "RAC-GE" air tight system for connection to pipe. Working temp. -10°C to 90°C. Applicable for the connection of low, medium and high density polyethylene pipe. Vulcanized NBR sealing. Stainless steel AISI 304 spring. Install in any position.

	P	Ø D	A
PE25 x PE25	20	41	85
PE32xPE32	25	50	100
PE40 x PE40	32	60	120

3124 05	25x25	0,284	-	-
3124 06	32x32	0,463	-	-
3124 07	40x40	0,744	-	-

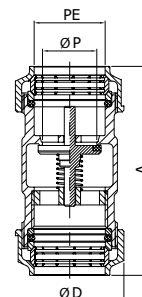

Ref. 0055

Boquilla inoxidable
Boquilla acero inoxidable AISI 304 de refuerzo para la utilización de racores en gas y agua caliente.

Stainless steel nozzle
Reinforcement stainless steel AISI 304 nozzle for using gas and hotwater connectors.

R	A	B	C	F
20	18	13,7	31	1
25	24	18,7	36	1
32	31,5	25,7	39	1
40	39	32,2	48	1
50	49	40,4	54	1
63	59,5	51	67	1
75	70	60,7	78,5	1,5
90	84	73,2	86,5	1,5
110	99	88,6	110	2

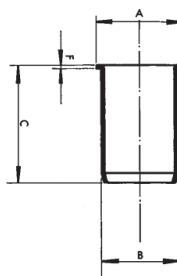

0055 04	20	0,010	100-2400	-
0055 05	25	0,015	75-975	-
0055 06	32	0,024	50-650	-
0055 07	40	0,040	30-420	-
0055 08	50	0,058	20-280	-
0055 09	63	0,092	10-140	-
0055 10	75	0,163	8-104	-
0055 11	90	0,236	6-78	-
0055 12	110	0,400	2-36	-

Ref. 0061

Junta tórica

O'ring

Medida/Size	Junta/O'ring
20	OR 20 x 2,5
25	OR 25 x 3
32	OR 32 x 3,5
40	OR 40 x 4
50	OR 50 x 4
63	OR 63 x 5
75	OR 75 x 7
90	OR 90 x 8
110	OR 110 x 8



0061 04	20	0,010	20-1	-
0061 05	25	0,010	20-1	-
0061 06	32	0,010	10-1	-
0061 07	40	0,010	10-1	-
0061 08	50	0,010	10-1	-
0061 09	63	0,010	5-1	-
0061 10	75	11,000	1	-
0061 11	90	18,000	1	-
0061 12	110	21,000	1	-

Ref. 0062

Anillo tope

Washer ring



0062 04	20	0,020	20-1	-
0062 05	25	0,020	20-1	-
0062 06	32	0,020	10-1	-
0062 07	40	0,020	10-1	-
0062 08	50	0,020	5-300	-
0062 09	63	0,020	5-1	-
0062 10	75	11,000	1	-
0062 11	90	18,000	1	-
0062 12	110	21,000	1	-

Ref. 0063

Anillo apriete

Necking



0063 04	20	0,030	10-1	-
0063 05	25	0,030	10-1	-
0063 06	32	0,030	10-1	-
0063 07	40	0,030	5-1	-
0063 08	50	0,030	2-1	-
0063 09	63	0,030	1-1	-
0063 10	75	95,000	1	-
0063 11	90	130,000	1	-
0063 12	110	200,000	1	-

ACCESORIOS LATÓN BRASS ACCESSORIES

SISTEMA DE APRIETE VALVEX "VALVEX" AIR TIGHT SYSTEM



- 1. Cuerpo Body
- 2. Tuerca Nut
- 3. Junta tórica O' ring
- 4. Anilla junta Washer ring
- 5. Anillo de apriete Necking
- 6. Boquilla para gas Nozzle

INSTRUCCIONES DE MONTAJE

El racor VALVEX ha sido estudiado cuidadosamente para facilitar la operación del montaje y por tanto, no requiere ninguna habilidad especial para su instalación. Sin embargo, aconsejamos seguir la operación de acoplamiento en el tubo, según el orden que a continuación citamos, respetando unas simples indicaciones:

- A Desmontar la tuerca o la brida de cierre e insertarla en el tubo.
- B Introducir en el tubo el anillo de apriete (5).
- C Introducir en el tubo el anillo - junta (4).
- D Introducir en el tubo la junta tórica (3).
- E Situar el tubo con todos los componentes en el cuerpo del racor hasta que el tubo no salga del fondo del mismo.
- F Apretar la tuerca o la brida en el cuerpo del racor.

Estas simples indicaciones evitan que imperfecciones en el tubo (Ej. imperfecciones residuales en el corte) impidan el perfecto acoplamiento, y en consecuencia un perfecto cierre.

ASSEMBLY INSTRUCTIONS

The VALVEX connector has been carefully studied in order to facilitate the assembly and therefore, it does not require any special skill to install it. However, we strongly recommend you follow the assembly instructions for the pipe, in the order listed below:

- A Disassemble the nut or the closing flange and insert it into the pipe.
- B Insert the necking (5) into the pipe.
- C Insert the washer ring (4) into the pipe.
- D Insert the o'ring (3) into the pipe.
- E Place the pipe with all the components inside the body of the connector until the pipe keeps fixed inside.
- F Tighten the nut or flange to the body of the connector.

These assembling instructions avoid that any imperfections in the pipe (e.g. residuals in the cut) could prevent the perfect assembling and sealing.

CÓDIGO MEDIDA PESO CAJA / BOX P.V.P. €
CODE SIZE WEIGHT CARTON PRICE €

Ref. 0010

Racor hembra

Female brass connector

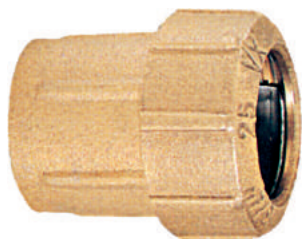

R	A	B	C
1/2" x 20	34	27	39,5
3/4" x 25	40	33	44,88
1" x 32	50	40	49,8
1 1/4" x 40	61	50	57,4
1 1/2" x 50	71	60	65,4
2" x 63	89	75	81,3

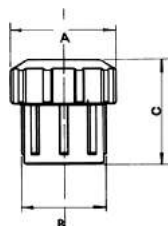

0010 04	1/2" x 20	0,086	20-220	-
0010 05	3/4" x 25	0,126	15-165	-
0010 06	1" x 32	0,210	12-120	-
0010 07	1 1/4" x 40	0,340	6-60	-
0010 08	1 1/2" x 50	0,472	4-32	-
0010 09	2" x 63	0,794	2-26	-

Ref. 0010

Racor hembra con bridas

Female connector with flanges



R	A	B	C
2 1/2" x 75	135	88	99,8
3" x 90	154	104	111,4
4" x 110	180	130	147

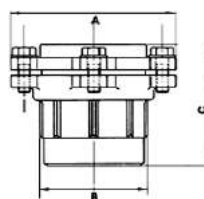

0010 10	2 1/2" x 75	1,530	4-16	-
0010 11	3" x 90	2,215	2-10	-
0010 12	4" x 110	4,468	2-4	-

Ref. 0015

Racor macho

Male brass connector

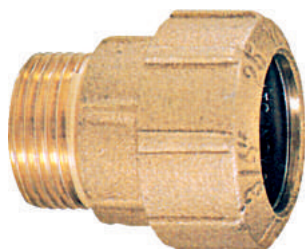

R	A	B	C
1/2" x 20	34	27	43
3/4" x 25	40	33	48
1" x 32	50	40	54,5
1 1/4" x 40	61	50	62,5
1 1/2" x 50	71	60	67,5
2" x 63	89	75	89

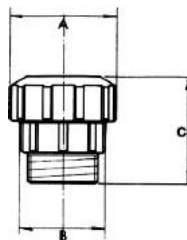

0015 04	1/2" x 20	0,082	20-220	-
0015 05	3/4" x 25	0,118	15-165	-
0015 06	1" x 32	0,202	12-120	-
0015 07	1 1/4" x 40	0,338	6-60	-
0015 08	1 1/2" x 50	0,440	4-32	-
0015 09	2" x 63	0,790	2-26	-

Ref. 0015

Racor macho con bridas

Male brass with flanges



R	A	B	C
2 1/2" x 75	135	88	105
3" x 90	154	104	115
4" x 110	180	130	143

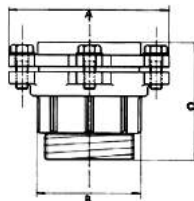

0015 10	2 1/2" x 75	1,553	4-16	-
0015 11	3" x 90	2,218	2-10	-
0015 12	4" x 110	4,320	2-4	-

Ref. 0020

Racor acoplamiento recto

Straight coupling double connector

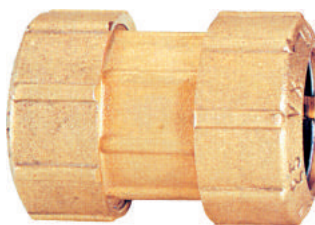

R	A	B	C
20	34	27	52
25	40	33	60
32	50	40	67
40	61	50	77
50	71	60	99
63	89	75	115

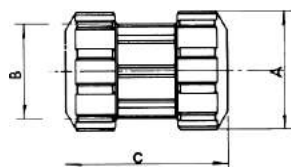

0020 04	20	0,132	12-192	-
0020 05	25	0,190	10-110	-
0020 06	32	0,305	8-64	-
0020 07	40	0,512	4-40	-
0020 08	50	0,662	2-32	-
0020 09	63	1,242	2-16	-

Ref. 0020

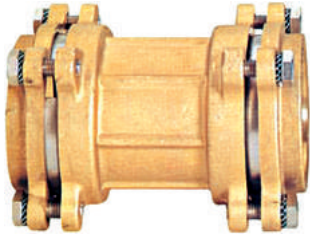

Racor acoplamiento recto con bridas

Straight coupling double connector with flanges

R	A	B	C
75	135	88	150
90	154	104	170
110	180	130	221

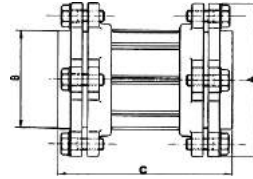

CÓDIGO CODE	MEDIDA SIZE	PESO WEIGHT	CAJA / BOX CARTON	P.V.P. € PRICE €
0020 10	75	2,513	4-8	-
0020 11	90	4,682	2-4	-
0020 12	110	7,445	1-2	-

Ref. 0025



Racor acoplamiento alargado

Long coupling double connector

R	A	B	C	D
32	50	40	115	50
40	61	50	125	50
50	71	60	139	50
63	89	75	163	50

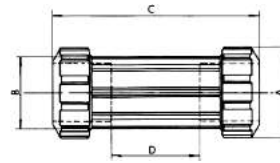

0025 06	32	0,406	6-48	-
0025 07	40	0,660	4-36	-
0025 08	50	0,910	2-20	-
0025 09	63	1,520	2-14	-

Ref. 0030



Racor "T" triple

"T" triple connector

R	A	C	E
20	34	77	38
25	40	90	45
32	50	105	52
40	61	125	62
50	71	145	72
63	89	185	92

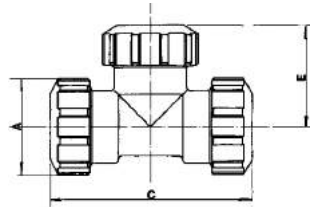

0030 04	20	0,228	6-96	-
0030 05	25	0,338	6-60	-
0030 06	32	0,556	4-32	-
0030 07	40	0,950	4-24	-
0030 08	50	1,264	2-18	-
0030 09	63	2,270	1-8	-

Nota: Para conseguir el racor "T" de 110 x 4" pedir figura 0035 + 0015.
Note: To obtain "T" connector 110 x 4" you must request for 0035 and 0015 connector.

Ref. 0030



Racor "T" triple con bridas

"T" triple connector with flanges

R	A	C	E
75	135	232	115
90	154	267	133

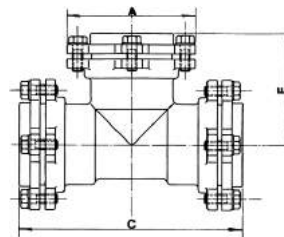

0030 10	75	4,190	1-4	-
0030 11	90	6,438	1-2	-

Nota: Para conseguir el racor "T" de 110 x 4" pedir figura 0035 + 0015.
Note: To obtain "T" connector 110 x 4" you must request for 0035 and 0015 connector.

Ref. 0035



Racor "T" hembra

"T" triple female connector

R	A	C	E
1/2" x 20	34	77	22
3/4" x 25	40	90	26
1" x 32	50	105	30
1 1/4" x 40	61	125	37
1 1/2" x 50	71	145	42,5
2" x 63	89	185	51

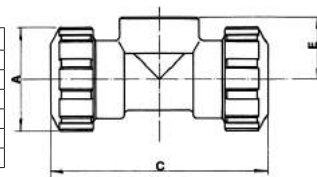

0035 04	1/2" x 20	0,180	8-128	-
0035 05	3/4" x 25	0,275	6-96	-
0035 06	1" x 32	0,435	4-40	-
0035 07	1 1/4" x 40	0,744	4-36	-
0035 08	1 1/2" x 50	1,000	2-26	-
0035 09	2" x 63	1,817	2-14	-

Ref. 0035

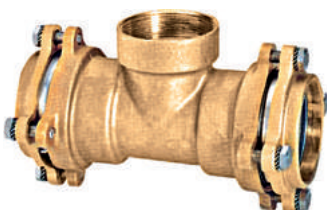

Racor "T" hembra con bridas

"T" triple female connector with flanges

R	A	C	E
2 1/2" x 75	135	226	75
3" x 90	154	259	85
4" x 110	180	314	100

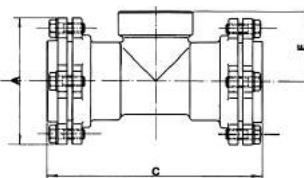

0035 10	2 1/2" x 75	3,450	1-8	-
0035 11	3" x 90	4,960	1-4	-
0035 12	4" x 110	9,740	1-2	-

CÓDIGO MEDIDA PESO CAJA / BOX P.V.P. €
CODE SIZE WEIGHT CARTON PRICE €

Ref. 0040

Racor "L" codo macho

"L" male elbow connector



R	A	C	E
1/2" x 20	34	36	37
3/4" x 25	40	40	42
1" x 32	50	47,5	50
1 1/4" x 40	61	55,5	60
1 1/2" x 50	71	62,5	68
2" x 63	89	76	87

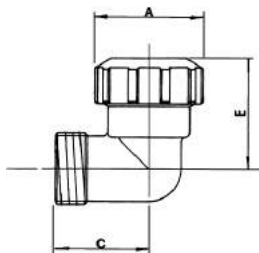

0040 04	1/2" x 20	0,110	15-165	-
0040 05	3/4" x 25	0,165	12-120	-
0040 06	1" x 32	0,275	8-64	-
0040 07	1 1/4" x 40	0,472	6-48	-
0040 08	1 1/2" x 50	0,605	4-32	-
0040 09	2" x 63	1,126	2-24	-

Ref. 0040

Racor "L" codo macho con bridas

"L" male elbow connector with flanges



R	A	C	E
2 1/2" x 75	135	95	111
3" x 90	154	107	133

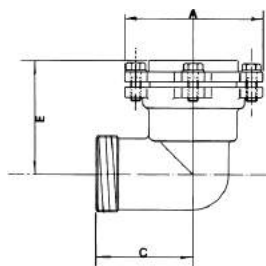

0040 10	2 1/2" x 75	2,125	1-8	-
0040 11	3" x 90	3,270	1-4	-

Ref. 0045

Racor codo hembra

"L" female elbow connector



R	A	C	E
1/2" x 20	34	22	38
3/4" x 25	40	26	45
1" x 32	50	30	52
1 1/4" x 40	61	37	62
1 1/2" x 50	71	42,5	71
2" x 63	89	51	92

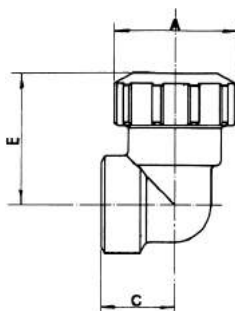

0045 04	1/2" x 20	0,114	15-165	-
0045 05	3/4" x 25	0,170	12-132	-
0045 06	1" x 32	0,330	8-64	-
0045 07	1 1/4" x 40	0,484	6-48	-
0045 08	1 1/2" x 50	0,754	4-32	-
0045 09	2" x 63	1,102	2-16	-

Ref. 0045

Racor codo hembra con bridas

"L" female elbow connector with flanges



R	A	C	E
2 1/2" x 75	135	75	113
3" x 90	154	85	130
4" x 110	180	100	157

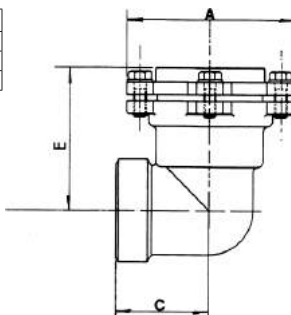

0045 10	2 1/2" x 75	2,115	1-8	-
0045 11	3" x 90	3,540	1-8	-
0045 12	4" x 110	5,934	1-4	-

Ref. 0050



Racor "L" codo a compresión
"L" elbow compression connector

R	A	C
20	34	38
25	40	45
32	50	52
40	61	62
50	71	72
63	89	92

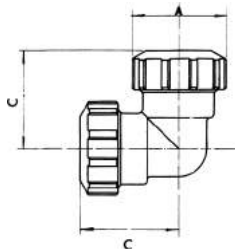

CÓDIGO CODE	MEDIDA SIZE	PESO WEIGHT	CAJA / BOX CARTON	P.V.P. € PRICE €
----------------	----------------	----------------	----------------------	---------------------

0050 04	20	0,130	12-120	-
0050 05	25	0,235	10-100	-
0050 06	32	0,385	6-48	-
0050 07	40	0,670	4-32	-
0050 08	50	0,870	2-16	-
0050 09	63	1,595	2-16	-

Nota: Para conseguir el racor "L" de 110 x 110 pedir figura 0045 + 0015.

Note: To obtain "L" connector 110 x 110" you must request for 0045 and 0015 connector.

Ref. 0050



Racor "L" codo con bridas
"L" elbow compression connector with flanges

R	A	C
75	135	116
90	154	133

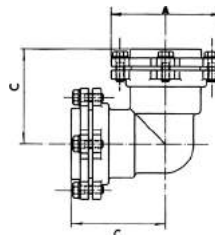

0050 10	75	3,040	1-8	-
0050 11	90	4,630	1-4	-

Nota: Para conseguir el racor "L" de 110 x 110 pedir figura 0045 + 0015.

Note: To obtain "L" connector 110 x 110" you must request for 0045 and 0015 connector.

Ref. 0048



Racor "L" codo hembra
"L" female brass elbow

R	A	B	C	D
1/2" x 20	34	35	36	16
3/4" x 25	40	40	46	18
1" x 32	50	48	51	23

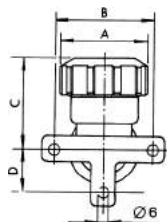

0048 04	1/2" x 20	0,142	15-120	-
0048 05	3/4" x 25	0,218	12-96	-
0048 06	1" x 32	0,322	8-64	-

Ref. 0055

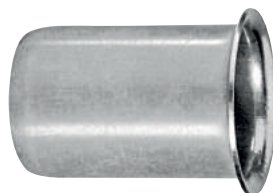

Boquilla inoxidable
Boquilla acero inoxidable AISI 304 de refuerzo para la utilización de racores en gas y agua caliente.

Stainless steel nozzle
Reinforcement stainless steel AISI 304 nozzle for using gas and hotwater connectors.

R	A	B	C	F
20	18	13,7	31	1
25	24	18,7	36	1
32	31,5	25,7	39	1
40	39	32,2	48	1
50	49	40,4	54	1
63	59,5	51	67	1
75	70	60,7	78,5	1,5
90	84	73,2	86,5	1,5
110	99	88,6	110	2

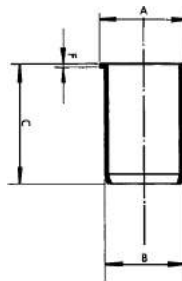

0055 04	20	0,010	100-2400	-
0055 05	25	0,015	75-975	-
0055 06	32	0,024	50-650	-
0055 07	40	0,040	30-420	-
0055 08	50	0,058	20-280	-
0055 09	63	0,092	10-140	-
0055 10	75	0,163	8-104	-
0055 11	90	0,236	6-78	-
0055 12	110	0,400	2-36	-

Ref. **0056**

Junta tórica

O'ring

CÓDIGO CODE	MEDIDA SIZE	PESO WEIGHT	CAJA / BOX CARTON	P.V.P. € PRICE €
----------------	----------------	----------------	----------------------	---------------------

0056 04	20	0,001	20-1	-
0056 05	25	0,003	20-1	-
0056 06	32	0,005	10-1	-
0056 07	40	0,006	10-1	-
0056 08	50	0,007	10-1	-
0056 09	63	0,009	5-1	-
0056 10	75	0,011	1-1	-
0056 11	90	0,018	1-1	-
0056 12	110	0,100	1-1	-

Ref. **0057**

Anillo junta tórica

Washer ring

CÓDIGO CODE	MEDIDA SIZE	PESO WEIGHT	CAJA / BOX CARTON	P.V.P. € PRICE €
----------------	----------------	----------------	----------------------	---------------------

0057 04	20	0,001	20-1	-
0057 05	25	0,002	20-1	-
0057 06	32	0,003	10-1	-
0057 07	40	0,004	10-1	-
0057 08	50	0,006	5-1	-
0057 09	63	0,014	5-1	-
0057 10	75	0,036	1-1	-
0057 11	90	0,051	1-1	-
0057 12	110	0,100	1-1	-

Ref. **0058**

Anillo de apriete

Necking

CÓDIGO CODE	MEDIDA SIZE	PESO WEIGHT	CAJA / BOX CARTON	P.V.P. € PRICE €
----------------	----------------	----------------	----------------------	---------------------

0058 04	20	0,002	10-1	-
0058 05	25	0,004	10-1	-
0058 06	32	0,005	10-1	-
0058 07	40	0,010	5-1	-
0058 08	50	0,014	2-1	-
0058 09	63	0,020	1-1	-
0058 10	75	0,034	1-1	-
0058 11	90	0,056	1-1	-
0058 12	110	0,100	1-1	-



2018

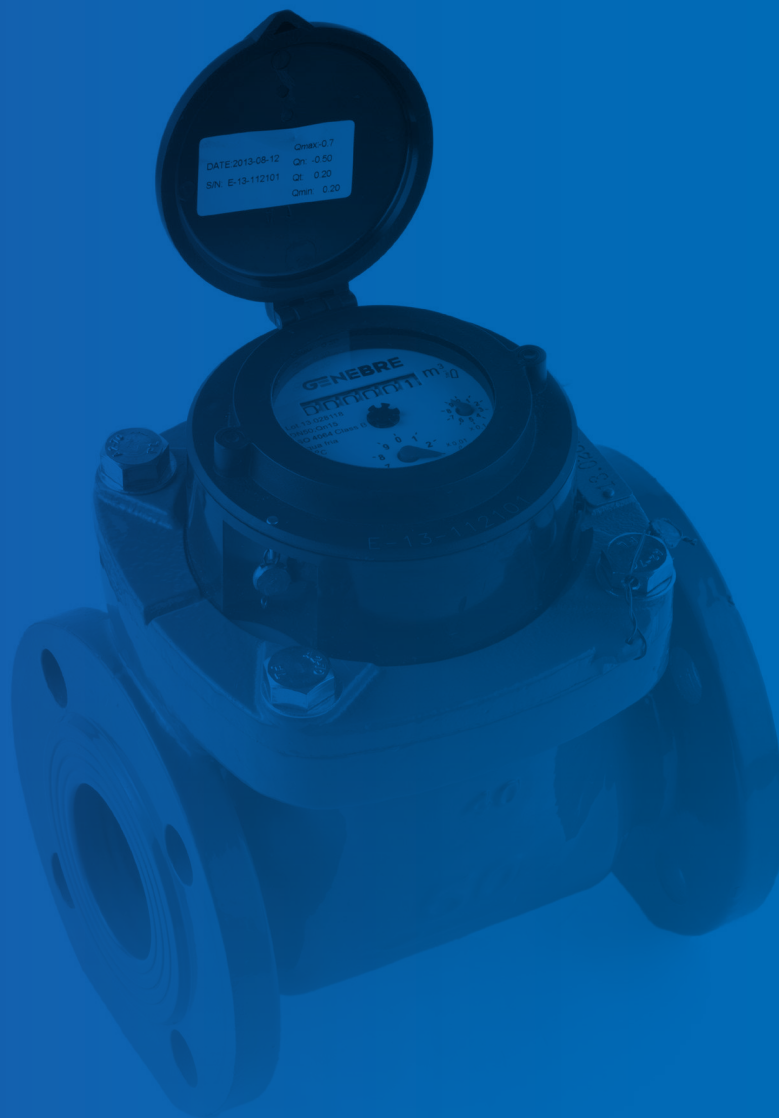

DATE: 2013-08-12
SN: E-13-112101

Qmax: 0.7
Qn: 0.50
Qmin: 0.20

GENEBRE
EXACTOFLUO m³/h



CONTADORES DE AGUA WATER METERS

**Contadores de agua de chorro único múltiple,
volumétricos, tipo Woltmann, y contadores
de calorías.**

Single or multiple flow, volumetric, and Woltmann type
water meters, as well as thermic energy meters.



Ref. 6010 - 6015 - 6020



Contador de agua de chorro único "EBRO" (Agua fría)
 Construcción: mecanismo de lectura totalmente seco, por transmisión magnética. Contador orientable a 360°. Montaje horizontal o vertical. Protección contra manipulación. Aprobación CE. Temperatura máxima 30°C. Presión máxima 10 bar. Clase de precisión B.

"EBRO" Single flow water meter (Cold water)
 Construction: totally dry reading mechanism, by magnetic transmission. Adjustable meter to 360°. Horizontal or vertical mounting. Protected against manipulation. EC approval. Maximum temperature 30°C. Maximum pressure 10 bar. Precision class: B.

DN	D1	D2	L1	L2	H1	H2
15	3/4"	1/2"	110	39	17	78
13-15	3/4"-7/8"	1/2"-1/2"	110	39	17-21	78
20	1"	3/4"	130	47	21	78

CÓDIGO CODE	MEDIDA SIZE	PESO WEIGHT	P.V.P. € PRICE €
6010 05	3/4" x 3/4" (DN 15)	0,411	-
6015 05	7/8" x 3/4" (DN 13-15)	0,411	-
6020 06	1" x 1" (DN 20)	0,546	-

6038 04	Racor / Connector 7/8" x 1/2"	0,030	-
6040 04	Racor / Connector 3/4" x 1/2"	0,070	-
6040 05	Racor / Connector 1" x 3/4"	0,115	-

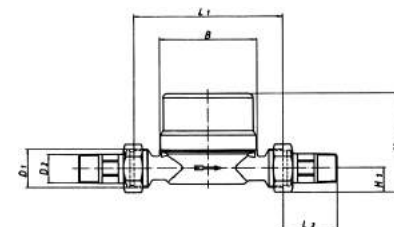

Ref. 6011 - 6021



Contador de agua de chorro único "EBRO" (Agua caliente)
 Construcción: mecanismo de lectura totalmente seco, por transmisión magnética. Contador orientable a 360°. Montaje horizontal o vertical. Protección contra manipulación. Aprobación CE. Temperatura máxima 90°C. Presión máxima 10 bar. Clase de precisión B.

"EBRO" Single flow water meter (Hot water)
 Construction: totally dry reading mechanism, by magnetic transmission. Adjustable meter to 360°. Horizontal or vertical mounting. Protected against manipulation. EC approval. Maximum temperature: 90°C. Maximum pressure 10 bar. Precision class: B.

DN	D1	D2	L1	L2	H1	H2
15	3/4"	1/2"	110	39	17	78
20	1"	3/4"	130	47	21	78

6011 05	3/4" x 3/4" (DN 15)	0,411	-
6021 06	1" x 1" (DN 20)	0,546	-

6040 04	Racor / Connector 3/4" x 1/2"	0,070	-
6040 05	Racor / Connector 1" x 3/4"	0,115	-

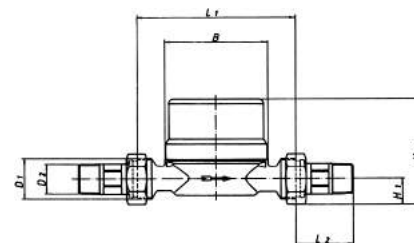

Ref. 6110C - 6120C



Contador de agua de chorro único (Agua fría)
 Construcción: mecanismo de lectura totalmente seco, por transmisión magnética. Contador orientable a 360°. Montaje horizontal o vertical. Protección contra manipulación. Aprobación CE. Temperatura máxima 30°C. Presión máxima 16 bar. Clase de precisión 2.

Single flow water meter (Cold water)
 Construction: totally dry reading mechanism, by magnetic transmission. Adjustable meter to 360°. Horizontal or vertical mounting. Protected against manipulation. EC approval. Maximum temperature 30°C. Maximum pressure 16 bar. Precision class: 2.

DN	D1	D2	L1	L2	H1	H2
15	3/4"	1/2"	110	47	17	84,5
20	1"	3/4"	130	52	21	84,5

6110C 05	3/4" x 3/4" (DN 15)	0,605	-
6120C 06	1" x 1" (DN 20)	0,820	-

Racor incluido / Included connector

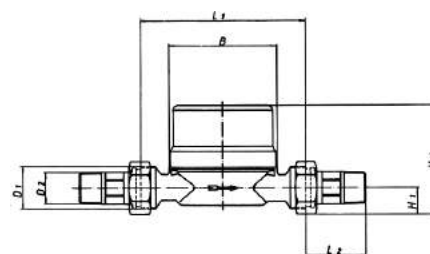

Ref. 6111C - 6121C



Contador de agua de chorro único (Agua caliente)
 Construcción: mecanismo de lectura totalmente seco, por transmisión magnética. Contador orientable a 360°. Montaje horizontal o vertical. Protección contra manipulación. Aprobación CE. Temperatura máxima 90°C. Presión máxima 16 bar. Clase de precisión 2.

Single flow water meter (Hot water)
 Construction: totally dry reading mechanism, by magnetic transmission. Adjustable meter to 360°. Horizontal or vertical mounting. Protected against manipulation. EC approval. Maximum temperature: 90°C. Maximum pressure 16 bar. Precision class: 2.

DN	D1	D2	L1	L2	H1	H2
15	3/4"	1/2"	110	47	17	84,5
20	1"	3/4"	130	52	21	84,5

6111C 05	3/4" x 3/4" (DN 15)	0,650	-
6121C 06	1" x 1" (DN 20)	820,000	-

Racor incluido / Included connector

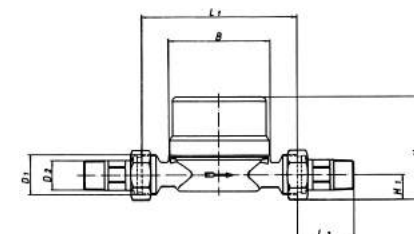

CÓDIGO MEDIDA PESO P.V.P. €
CODE SIZE WEIGHT PRICE €

Ref. 6029

Contador de agua de chorro múltiple (Agua fría)

Contador de dial seco para agua fría. Montaje horizontal. Aprobación CE. Temperatura máxima 30°C. Presión máxima 16 bar. Clase de precisión 2.

Multiple flow water meter (Cold water)

Dry dial meter for cold water. Horizontal mounting. EC approval. Maximum temperature: 30°C. Maximum pressure 16 bar. Precision class: 2.

DN	d	D	b1	b2	c	g
15	3/4"	1/2"	165	259	107,5	94
20	1"	3/4"	190	294	107,5	94
25	1 1/4"	1"	260	380	117,5	98
32	1 1/2"	1 1/4"	260	384	117,5	98
40	2"	1 1/2"	300	431	141,5	122

6029 05	3/4" x 3/4" (DN 15)	1,680	-
6029 06	1" x 1" (DN 20)	1,880	-
6029 07	1 1/4" x 1 1/4" (DN 25)	2,920	-
6029 08	1 1/2" x 1 1/2" (DN 32)	3,690	-
6029 09	2" x 2" (DN 40)	6,140	-

Racor incluido / Included connector

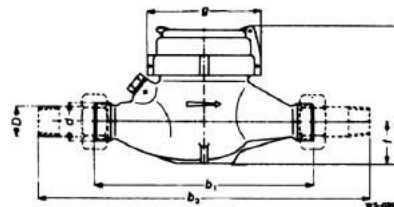

Ref. 6029P

Contador de agua de chorro múltiple (Agua fría)

Construcción: tecnopolímero. Contador de dial seco para agua fría. Montaje horizontal. Temperatura máxima 40°C. Presión máxima 16 bar. Clase de precisión B. Montaje horizontal.

Multiple flow water meter (Cold water)

Construction: plastic body. Dry dial meter for cold water. Horizontal mounting. Maximum temperature: 40°C. Maximum pressure 16 bar. Precision class: B. Horizontal mounting.

DN	d	D	b1	b2	c	g
15	3/4"	1/2"	165	259	105,5	98
20	1"	3/4"	190	294	107	98
25	1 1/4"	1"	260	380	107	98

6029P 05	3/4" x 3/4" (DN 15)	0,695	-
6029P 06	1" x 1" (DN 20)	806,000	-
6029P 07	1 1/4" x 1 1/4" (DN 25)	0,990	-

Racor incluido / Included connector

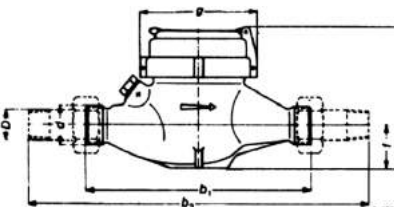

Ref. 6090

Contador de agua volumétrico - pistón rotativo (Agua fría)

Aplicación en zonas residenciales. Temperatura máxima 30°C. Presión máxima 16 bar. Aprobación CE. Clase de precisión 2.

Volumetric rotary piston water meter (Cold water)

For residential applications. Maximum temperature 30°C. Maximum pressure 16 bar. CE approval. Accuracy class 2.

DN	d	D	b1	b2	c	g
15	3/4"	1/2"	165	259	114	99

6090 05	3/4" x 3/4" (DN 15)	1,500	-
---------	---------------------	-------	---

Racor incluido / Included connector

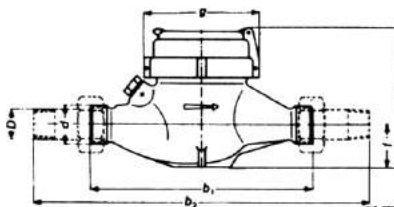

Ref. 6192

Contador de agua volumétrico - pistón rotativo (Agua fría)

Aplicación en zonas residenciales. Temperatura máxima 50°C. Presión máxima 16 bar. Clase de precisión C.

Volumetric rotary piston water meter (Cold water)

For residential applications. Maximum temperature 50°C. Maximum pressure 16 bar. Precision class: C.

DN	D	d	L	L1	W
15	3/4"	1/2"	115	209	90

6192 05	3/4" x 3/4" (DN 15)	1,130	-
---------	---------------------	-------	---

Racor incluido / Included connector

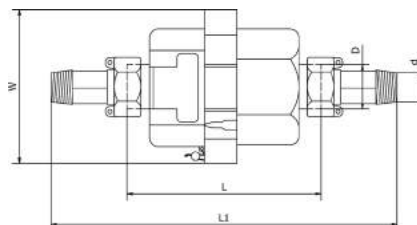

Ref. 6060



WOLTMANN

Contador de agua tipo WOLTMANN con bridas DIN

Para la medición del consumo de agua fría. Registro seco. Pérdida de presión mínima. Precisión de medición conforme a la Norma UNE-EN 14154, clase de precisión 2. Posición de montaje horizontal, vertical o inclinado (se recomienda el montaje en posición horizontal y con el medidor hacia arriba). Condiciones de trabajo: Temperatura máxima del agua: 30°C. Presión máxima de trabajo: 16 bar. Extremos conexión bridas DIN. Equipado con salida de impulsos. Aprobación CE

WOLTMANN water meter with DIN flanges

For measurement of high flows of cold water. Dry-dial. Low pressure loss. Measuring accuracy conform to UNE-EN 14154, accuracy class 2. The meter can be installed in horizontal - vertical or inclined position (a horizontal position with the register face upwards is recommended). Working conditions: Maximum water temperature: 30°C. Maximum working pressure: 16 bar. DIN flanges ends connection. Pulse output equipped. CE approval.

DN	L	H	D	D1	Agujeros/Holes (mm)	Peso/Weight (Kg)
50	200	400	165	125	4 x 18	12
65	200	400	185	145	4 x 18	13
80	225	400	200	160	8 x 18	14
100	250	400	220	180	8 x 18	16
125	250	400	250	210	8 x 18	20
150	300	500	285	240	8 x 22	31
200	350	500	340	295	12x22	40
250	450	710	405	355	12 x 26	83

CÓDIGO CODE	MEDIDA SIZE	P.V.P. € PRICE €
6060 09	DN50 Bridas 2" / DN50 Flanges 2"	-
6060 10	DN65 Bridas 2 1/2" / DN65 Flanges 2 1/2"	-
6060 11	DN80 Bridas 3" / DN80 Flanges 3"	-
6060 12	DN100 Bridas 4" / DN100 Flanges 4"	-
6060 13	DN125 Bridas 5" / DN125 Flanges 5"	-
6060 14	DN150 Bridas 6"	-
6060 16	DN200 Bridas 8" / DN200 Flanges 8"	-
6060 18	DN250 Bridas 10" / DN250 Flanges 10"	-

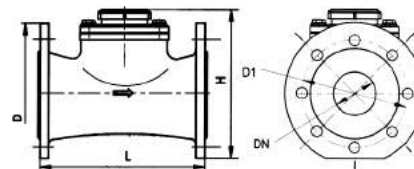

Ref. 6060A



WOLTMANN

Contador de agua tipo WOLTMANN con bridas ANSI

Para la medición del consumo de agua fría. Registro seco. Pérdida de presión mínima. Precisión de medición conforme a la Norma ISO 4064, clase de precisión 2. Posición de montaje horizontal, vertical o inclinado (se recomienda el montaje en posición horizontal y con el medidor hacia arriba). Condiciones de trabajo: Temperatura máxima del agua: 30°C. Presión máxima de trabajo: 16 bar. Extremos conexión bridas ANSI. Equipado con salida de impulsos.

WOLTMANN water meter with ANSI flanges

For measurement of high flows of cold water. Dry-dial. Low pressure loss. Measuring accuracy conform to ISO 4064 Standard, accuracy class 2. The meter can be installed in horizontal, vertical or inclined position (a horizontal position with the register face upwards is recommended). Working conditions: Maximum water temperature: 30°C. Maximum working pressure: 16 bar. ANSI flanges ends connection. Pulse output equipped.

Med./ Size	L	H	D	D1	Agujeros/Holes (mm)	Peso/Weight (Kg)
2"	200	252	165	120,65	4 x 19	12
2 1/2"	200	262	185	139,7	4 x 19	13
3"	225	272	190,5	152,4	4 x 19	15
4"	250	282	228,6	190,5	8 x 19	18
5"	250	297	254	215,9	8 x 22	23
6"	300	341	279,4	241,3	8 x 22	37
8"	350	371	343	298,5	8 x 22	47
10"	450	480	406,4	362	12 x 25	94
12"	500	516	482,6	431,8	12 x 25	134

CÓDIGO CODE	MEDIDA SIZE	P.V.P. € PRICE €
6060A 09	DN 50 Bridas 2"/DN 50 Flanges 2"	-
6060A 10	DN 65 Bridas 2 1/2"/DN 65 Flanges 2 1/2"	-
6060A 11	DN 80 Bridas 3"/DN 80 Flanges 3"	-
6060A 12	DN 100 Bridas 4"/DN 100 Flanges 4"	-
6060A 13	DN 125 Bridas 5"/DN 125 Flanges 5"	-
6060A 14	DN 150 Bridas 6"/DN 150 Flanges 6"	-
6060A 16	DN 200 Bridas 8"/DN 200 Flanges 8"	-
6060A 18	DN 250 Bridas 10"/DN 250 Flanges 10"	-
6060A 20	DN 300 Bridas 12"/DN 300 Flanges 12"	-

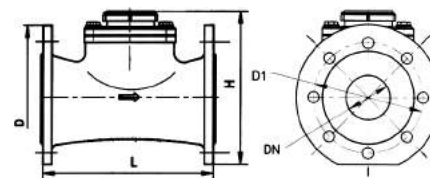

Ref. 6066



Emisor de impulsos para Woltman

Sensor de contacto libre de potencial. Cable de 2 hilos por 1,5 m de longitud.

Woltman pulse transmitter

Switch sensor potential free. 2 wire cable and 1.5 m length.

CÓDIGO CODE	MEDIDA SIZE	P.V.P. € PRICE €
6066		-

CÓDIGO
CODE

MEDIDA
SIZE

P.V.P. €
PRICE €

Ref. 6085

Contador de calorías

Los contadores de energía térmica de tipo compacto se utilizan para la contabilización del consumo de la energía térmica en aplicaciones de calefacción. Compuesto de unidad de cálculo de consumo energético, display de visualización de 8 dígitos, teclado de interacción usuario, contador de chorro único con la sonda de retorno insertada en el propio cuerpo del contador y sondas PT500 Ø 5 mm. Red de comunicación M-bus. Certificado MID (2004/22/CE).

Instalación del contador en la tubería de retorno. Montaje en horizontal o vertical. PN10 bar. IP54. Alimentación por batería de litio 3 V. Longitud del cable sonda 1,5 m. Rango de temperatura de fluido desde 15°C a 90°C.

Thermic energy meter

The compact thermic energy meters are used to score the thermic energy consumption in a heating instalations. Components: Energetic consumption calculation unit, 8 digits display, keyboard user, single jet meter with return probe inserted into the body's meter and PT500 Ø 5 mm probes. M-bus communication net. MID (2004/22/CE) Certificate.

Meter installation on the return pipe. Horizontal or vertical mounting. PN10 bar. IP54. Lithium battery power supply. 1.5 m probe cable length. Flow temperatures range from 15°C to 90°C.

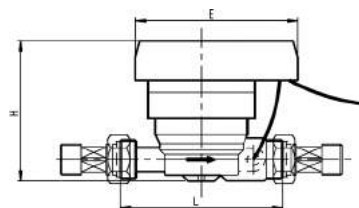

6085 05	Contador de calorías DN 15 - 3/4" / Thermic energy meter DN 15 - 3/4"	-
---------	---	---

Tamaño / Size (DN)	Caudal / Flow rate			Longitud / Length L (mm)	Altura / Height H (mm)	Unidad cálculo / Compute unit E (mm)	Rosca sonda / Probe thread	Longitud sonda / Probe lenght (mm)
	Q max. m/h	Q m/h	Q min. l/h					
3/4" (15 mm)	3	1,5	7	110	95	110 (110 x 80)	M10 x 1	35

Ref. 6045

Tapa contador EBRO

EBRO meter cover

6045 00		-
---------	--	---



Ref. 6040 - 6038

Racor con junta

Connector with joint



6040 04	Racor / Connector Racor / Connector 3/4" x 1/2"	-
6040 05	Racor / Connector Racor / Connector 1" x 3/4"	-
6040 06	Racor / Connector 1 1/4" x 1"	-
6040 07	Racor / Connector 1 1/2" x 1 1/4"	-
6040 08	Racor / Connector 2" x 1 1/2"	-
6038 04	Racor / Connector Racor / Connector 7/8" x 1/2"	-

Ref. 6041

Adaptador

Adaptor

6041 05	Adaptador/Adaptor 3/4" x 7/8"	-
---------	-------------------------------	---





2018

CONDICIONES GENERALES DE VENTA GENERAL SALES CONDITIONS

PRECIOS: Los precios se entienden en nuestro almacén, siendo los portes, el I.V.A. y acarreo a cargo del comprador, salvo acuerdo previo en contra.

CONDICIONES DE PAGO: En aplicación de la Ley 15/2010 que limita los plazos máximos de pago en las operaciones comerciales, hemos ajustado las condiciones a lo dispuesto en la misma. En caso de diferirse el pago, los gastos de negociación de efectos y/o los intereses legales especificados serán a cargo del comprador. El impago de cualquier efecto o recibo, conllevará la inmediata suspensión de suministros y servicios.

PEDIDOS: Para la tramitación de cualquier suministro será indispensable que el comprador nos remita el pedido por escrito indicando claramente la referencia Genebre, incluidos los dígitos de la medida y también la cantidad deseada en base a las unidades de compra mínima (por caja), tal como especifica Genebre en su catálogo. Si existen condicionantes no previstos, Genebre S.A. se reserva el derecho de aceptación o anulación de los pedidos cursados. Cada pedido solicitado a Genebre S.A. genera una expedición para el cliente con su coste de transporte correspondiente; por lo que recomendamos preparen sus pedidos completos una vez al día para optimizar el transporte. Todos los pedidos serán confirmados por Genebre, S.A. vía email/fax. Salvo notificación de lo contrario en las siguientes 24 horas, el pedido confirmado seguirá su curso sin derecho a posteriores reclamaciones.

TARIFAS DE PRECIOS: Genebre S.A. comunicará a sus clientes cualquier cambio que se produzca en las tarifas del catálogo a través de alguna de las vías de comunicación usuales (web, email, correo).

CANCELACIÓN DE PRODUCTOS DE CATÁLOGO: Genebre, S.A. comunicará a sus clientes cualquier cancelación de productos del catálogo.

ESPECIFICACIONES TÉCNICAS: El catálogo de Genebre, S.A. contiene los requisitos técnicos y normas aplicables a los productos suministrados. Genebre S.A. se reserva la facultad de cambiar en todo o en parte el diseño y materiales de cualquiera de sus productos, debido a la mejora continua de nuestros productos.

EXPEDICIONES: Todo pedido superior a 500 euros en Península se suministran a portes pagados. Para Canarias, Ceuta, Melilla y Andorra, el pedido mínimo será de 1.000 euros. Las mercancías viajan siempre por cuenta y riesgo del comprador, aún en los casos de convenios especiales.

ENTREGA: Los pedidos se suministrarán siempre por cajas completas, según especificaciones de catálogo.

RECLAMACIONES: Las eventuales reclamaciones deberán formularse dentro de los 15 días siguientes al de recepción de la mercancía por el comprador, rechazándose las efectuadas después de dicho plazo límite. NO se aceptará ninguna devolución de material sin aprobación previa de nuestro Departamento Comercial que facilitará un número de boletín de devolución que debe acompañar al material devuelto. Todas las devoluciones serán con los portes a cargo del comprador. Y se realizará un cargo por demérito del 10% del valor de la mercancía para todos los materiales, excepto para las válvulas automatizadas que será del 30%.

GARANTÍA: Queda limitada al reemplazo de las piezas reconocidas como defectuosas de fabricación por el Departamento de Calidad de Genebre S.A.. No admitiremos ninguna reclamación transcurridos 15 días de la recepción de la mercancía por el comprador.

PROPIEDAD DE LA MERCANCÍA: Genebre, S.A. se reserva el derecho de propiedad de la mercancía suministrada, hasta que el comprador no haya satisfecho totalmente el importe de la misma. En el intervalo, se considerará en concepto de depósito y custodia. La mercancía podrá ser retirada por incumplimiento de pago en el plazo previamente estipulado.

LITIGIOS: En caso de litigio, ambas partes aceptan someter sus diferencias a los Juzgados de L'Hospitalet de Llobregat.

PRICES: Prices are considered to be EX WORKS, being the freight and transportation at the cost of the purchaser, unless previous agreement has been reached.

PAYMENT TERMS: We have adjusted the conditions in application of Law 15/2010 which limits the maximum terms of payment in commercial transactions. The maximum delay on payment will be of 60 days after invoice date. Payment term will be as accorded between the parties. In case of unpaid, the expenses and interest occurred will be paid by the purchaser. The unpaid maturity will imply the complete suspension of any service or supply.

ORDERS: Regarding the handling of any supply, it is compulsory for the purchaser to send a written signed and sealed purchasing order indicating clearly Genebre's reference, including measures digits, and also the quantity required according to obligated minimum units of purchase (boxes), as Genebre's Catalogue specifies. In case of unexpected discrepancies, Genebre has the right to accept or cancel the pending orders. Each order required to Genebre, S.A., opens a client expedition with corresponding transports cost, because of that, we recommend to prepare complete orders once a day to improve the transport. All the orders will be confirmed by Genebre by e-mail/fax. Each confirmed order will be handled without any right from the purchaser to modify it, unless previous notification before 24 hours after confirmation.

PRICE LIST: Genebre will inform the customers about any change in the price list, using some usual communication way (web, e-mail or post).

PRODUCTS WITHDRAWAL FROM CATALOGUE: Genebre S.A. will inform the customers about any product withdrawal from the catalogue.

TECHNICAL SPECIFICATIONS: Genebre's catalogue holds all the technical requirements and applicable norms about the products.

SHIPMENT: Goods are shipped under the purchaser's own risk, even in special cases.

DELIVERY: Orders will always be shipped according to full boxes, as specified in the catalogue.

CLAIMS: Eventual claims must be done within 15 days after date of reception of the goods by the purchaser. Claims after such period will not be considered. NO devolution will be accepted without the previous approval from our Sales Department, who will issue a devolution certificate that must be enclosed in the devolution goods. All devolutions' freight will be paid by the purchaser. Additionally, an unworthiness debit of 10% of the products' value will be charged, except for the automatic valves that are a 30%.

GUARANTEE: It is limited to defective pieces replacement identified by Genebre's Quality Department. We will not accept any return after 15 days from the date of reception by the purchaser.

PROPERTY OF THE GOODS: Genebre has the property right of the supplied goods, until the purchaser has totally paid its value. In the meantime, it will be considered as deposit and custody. Goods shall be claimed in case of breach of payment terms.

DISPUTES: In case of disputes, both parties agree to solve discrepancies in the Barcelona Court of Justice.



2018



GENEBRE

GENEBRE GROUP

Edificio Genebre, Avda. Joan Carles I, 46-48
08908 L'Hospitalet de Llobregat (Barcelona) ESPAÑA
www.genebre.es